



The Earth News-Sun

"A CONSOLIDATION OF THE EARTH NEWS AND EARTH SUN, OCTOBER 12, 1966"



WINNER
of the Distinguished
Service Award of the
Vocational Agriculture Teachers
Association of Texas

VOLUME 12

10 CENTS

EARTH, LAMB COUNTY, TEXAS, THURSDAY, FEBRUARY 17, 1966

10 PAGES

NUMBER 24

* **NOSIN...** *
* With Polly *

The "Valentines for Hero's in Vietnam" project recently undertaken by our local FFA Chapter, along with several other chapters over the Plains, resulted in letters of appreciation from some of the boys receiving the Valentines and gifts from the local chapter.

February 11, 1966
Da Nang, Vietnam

Dear Jamie,

The Chaplin brought around a big box of Valentines and was much surprised to see that its from a Texan! You see I am from Texas myself, Texas Chapter that is. Its just a little town 18 miles from Galveston and about 25 miles from Houston.

Lets see now, I'll tell you about myself. I am 6'2", 175 lbs, blond hair, blue eyes, and am 20 years old. I have been in the Navy for 3 years and 6 months. I am due to be discharged August 22, 1966. (I hope!) I have been where the fighting is and have been wounded twice. Thats why I am here at a Medical Battalion. I have seen many men killed and some were Texans, but they died like a Texan would want to die, fighting. Combat is something that one cannot explain, you have to be there to see, feel and see the pain. I can sum it up in two words I guess, "Living Hell!" Its hot here year round and its usually about 95 degrees in the shade. In the summer months it gets up usually about 130 degrees in the shade.

I better explain what I do here, well, I am a Navy Hospital Corpsman attached to the Marines. I was with 2nd Battalion, 1st Marines and I am now with "C" Company, 3rd Medical Battalion. It's terribly lonely here and I must say I will be glad if you would write. I have no girl and I don't get much mail. I did have a girl, I was going to marry but, I got the old "Dear John Letter."

I hope you will send a picture of yourself to me. I sure do get tired of looking at the ugly faces of the guys. A beautiful face would keep me going for days. I will send you a picture as soon as I can get some. It's kind of hard to get pictures around here. I mean get them developed and printed.

I am also a musician, rock and roll style. Before I came over here I was working with a group in California. We made the big times, but we were all sent to Viet Nam. By the way, I am a drummer.

Well, I must close now. Please send a picture and write. I've got to get back to work.

From a fellow Texan,
Jon

My address is:
Jon Lo Sherwood Hn 6997112
3rd Medical Battalion
"C" Company
% F. P. O. San Francisco, Calif.
96601.

Dear Jamie,

Well I really don't know how to start off this letter. Well first of all I received your valentines card here at the hospital. I want to say thanks. I guess you are wondering what I am doing in the hospital, well Monday we got hit by VC. I was carrying ammunition to our mortar when I got hit on the leg with fragments off a hand grenade. I am OK. I won't be able to get around much but that's OK. Well enough of that. I don't really have much to say. I want to come back to the States. I guess you want to know a little about me. Well to start off with I am a pfc, I have black hair, green eyes and about 5'7. Well enough about me. I would like to hear from you and you tell me about yourself.

Yours truly,
Pfc David Andeode

PS: Thank again for the card.

V. D. Coker entered the Littlefield Hospital on Monday, February 7, after suffering a heart attack.

He is reported to be improving somewhat. However he is still under a special nurse's care at night.

11:30 A. M. IN SCHOOL AUDITORIUM

Attend "Operation Teenager" Today

"Operation Teenager" is scheduled for 11:30 a. m. Thursday in the Springlake-Earth School Auditorium. Everyone in the area is invited to attend this program co-sponsored by the Lions Clubs of Springlake and Earth along with the local P. T. A.

The idea of "operation teenager" was born in January of 1962, when a young inmate who worked in the education department of the Texas Department of Corrections read an article about three inmates of the Hawaiian Penal System being permitted to make talks to audiences of young people outside the prison.

After some thought, he discussed the matter with three other inmates, and the four began thinking of the possibility of starting a similar program in the Texas Department of Corrections. For weeks, they discussed different ideas during their leisure time about the type of program that could possibly prevent teenagers from making mistakes that would eventually lead to prison. Each man was deeply concerned about the rising tide of juvenile crime and the increasing number of young men and women entering the gates of the penitentiary.

It is very unusual for men in prison to admit the mistakes they have made. A great disadvantage of the early discussions was that one could live for many years with another man, and yet, not really know him. After a few sessions of breaking the ice, each man started to reveal the true facts about himself. It was difficult for them to start, but as they progressed, they began to know themselves, possibly for the first time. It soon became apparent to the men that their crimes hadn't just happened. They realized that their real trouble had started during their teenage years when they were forming habits and attitudes, choosing goals and ideals, whether good or bad, that they would carry with them into their adult life. It was then plain to these men that if such a program was to be successful and effective in helping young people, they must be scrupulously honest and sincere about themselves in the presentation.

Fortunately, each of the four men had different family and ethnic backgrounds so that their stories would not be repetitive; One had been raised in an upper class family and was a college graduate; another had come from lower class surroundings of a large city; one was familiar with torment and heartbreak of a broken home; the fourth was the son of a tenant farmer. Each had a different story to tell, and each felt that by sharing his story with teenagers, the young people could be made to see the waste, futility, and tragedy that results from a life of crime. In this way, they hoped to help others from committing similar mistakes in the struggle to maturity.

The officials of the Texas Department of Corrections were quick to see the merit and potential value of the program when they were approached by the four inmates. The four men began making appearances in February of 1962, and to date, have delivered their talks to more than 650,000 youths of Texas. They are accompanied in their travels to fill engagements by an employee of the education department in the prison system.

The impact of the presentation on anyone who has seen it will bear testimony as to the effectiveness of the program and the beneficial results that have been achieved. The reaction, response, and support the project has received is indicative of its success. Many commendations have been received from parents, educators, clergymen, and law enforcement officials, but the most numerous and gratifying come from the young people themselves. Some of the more frequent comments received from teenagers are: "You certainly have made me realize the things I have been doing wrong," and, "You have made me see that men in prison are no different than anyone else." Another comment heard very often is, "We see that it can happen to us if we aren't careful in choosing friends, habits, and ideals by which we live. Often, young people confess past mistakes and express gratitude for having the opportunity of seeing where they were headed.



FORMAL OPENING at the Earth Beauty Salon Tuesday was a day of visiting and getting acquainted with area residents for manager, Jack Griswold. Pictured are Mr. Shirley Huffington, Mrs. Linda Griswold, Lena Hite, receptionist, Griswold, and Mrs. Elmer Wolfe.

Good Attendance Reported At Open House

Open house at the Earth Beauty Salon Tuesday turned out to be a big success with approximately 40 people registering for the free gifts.

The three winners of the prizes were Mrs. Gary Cowley, first prize, which was a free shampoo and set, manicure and facial, Alicia Galloway won the second prize which was a free facial, and Helen Phillips won the third prize which was a free manicure.

Delicious refreshments of punch coffee, and cookies were served to those attending by Mrs. Ted Allen, Muleshoe.

Mrs. Lena Hite was receptionist. The firm received several floral arrangements, potted plants, and rubber plants from those who wished them well.

Jack Griswold, manager of the Beauty Salon, invites your continued patronage.

by Sue Ann Brunner

Springlake Church Plans Gospel Meeting

The Church of Christ in Springlake will begin a gospel meeting February 28.

Jack Orblson from Fargo, North Dakota, will preach, and singing will be led by Meredith Crawford from Olton.

Services will be held each morning at 10:00 a. m. and each evening at 7:30 p. m. Everyone is cordially invited to attend the meeting.



DISTRICT CHAMPS the unbeaten Wolverettes with 10 consecutive victories in district play were named "Champs" Friday night following a game with Kress which ended District play. It was a toss-up as to who was the happiest, the team or the Coach. Pictured proudly holding the Championship trophy are, senior members of the team, Helen Phillips, Diana Gregory, Alicia Washington, and Dwala Boone. Standing is Carolyn Hucka, Linda Gregory, Anita O'Hair, Pansy Beem, Linda Jordan, Coach Dean Foshee, Beverly Prather, Dalpha Banks, Susan Britton, Judy Gover, and Mirsha Dawson.

Local School Board Amends Budget

Present Total
\$455,877

The local board voted to amend the original school budget of \$448,377 to take in a recent grant from the Federal government. The amended budget is presently in the amount of \$455,877. The major categories involved in the increased budget is specified for the purchase of library books and equipment.

The board discussed the probability of a night time reading program to be handled similar to the summer drivers education class, as a tuition class. Supr. Mann said there would be no reason why the equipment would not be available for use if a teacher were available to instruct the class or classes. However no concrete decision was reached.

In discussing the reading classes Mann explained to the board, that since Springlake-Earth began their reading class after the beginning of the second semester and all the students had by that time enrolled in something else, there was no time available throughout the day to work in these new reading classes, as a result the best thing they could figure out was to take students out of other classes, that would hurt them less to be omitted. Such as health classes etc., where they had received one semester study or more, and had placed them in the new federal financed reading classes. Though they were not attending these classes this semester, they were continuing to receive a grade in these classes from which they had been taken from.

At least one board member questioned the practice of giving a grade to students who no longer attended such classes. Mann, explained that in some cases a plan had previously been set up where students were to take certain subjects for a number of years in order to graduate. If they failed to receive these grades in these subjects, it might tend to prevent a student from graduating at the proper time. He went on to explain, it was his understanding that this practice was customary in schools all over the Panhandle.

The matter seemed to be dropped at that point. The board voted to have a school board election April 2 in the study hall of high school building. The two vacancies on the board are those created by the terminations of the three year terms of Orville Cleaveger and Price Hamilton. Candidates may file by obtaining an application form from the Superintendent's office. Deadline for filing is set for March 2.

Absentee voting will begin March 10 through March 29. This can be done in school tax office from 8:30 a. m. to 4:30 p. m. daily. Mrs. Leon Dent has been appointed absentee clerk. Phil Laught was named election judge, with Dwayne Jones selected as alternate judge and clerk. The two additional (Continued on page 3)

Junior Fat Stock Show Set For February 25-26

The annual Junior Fat Stock Show will be held on Friday and Saturday, February 25 and 26 at the show barn in Earth, Springlake, and surrounding areas.

A large attendance is expected, as local and area visitors support the Juniors in their annual project. Approximately 85 head of animals will be exhibited which includes 17 calves, 25 lambs, and 43 barrows.

Vocational agriculture teacher, E. G. Gaston is assisting the junior livestock members in preparing the animals for the show.

Judging will be L. M. Hargraves from Texas Tech College, Lubbock. Members of the Junior Fat Stock Show met recently, and organized a sales committee, headed by Doug Lewis. Committee members are Eddie Haydon, J. W. Dear, Billy Braden, Robert Riley, Roger Haber, D. K. Lewis, Norman Hinchliffe, Mike Dent, Bob Waide, Price Hamilton, L. D. Henderson, Lewis Faver, Gene

Templeton, and Donald Runyon. They will contact each and every business house in Earth, Springlake, and surrounding areas. The persons contacted by the committee may make donations or indicate which animal they would like to buy, or delegate some member of the Junior Livestock Show to buy the animal for them. The sales group plans to contact persons as well as businessmen.

There will be prize plaques and trophies awarded to the buyer of the Grand Champion and Reserve Grand Champions. The chairman and his committee and the board of directors of the livestock show are working diligently to create in interest and sales for the support of the Junior Livestock show.

The Board of Directors are: John Bridges, president, Ed Dawson, Secretary-treasurer, J. W. Dear, L. D. Henderson, James Sanderson, Bud Matlock, Orville Cleaveger, and Jeart James.

Salvation Army Fund Drive Needs Completing

M. H. "Dutch" Been announced Tuesday that the Salvation Army Campaign to date has reached the \$414 mark, with about one half of the contribution reported.

He urges all workers who have not completed the solicitation to please do so as the board hopes to be able to wind the campaign up within the next week.

Those who have received mail appeal letters are asked to reply as soon as possible.

Anyone who has not been contacted by a volunteer worker or a mail appeal letter and would like to contribute to this worthy cause is asked to make a check out to the Salvation Army and mail it to Mrs. Lynn Glascock, in care of the Citizens State Bank, Earth.

Voter Registration Bill Now Before Legislators

State Representative, Bill Clayton of Springlake called from Austin Tuesday afternoon to report the House and Senate had met Monday in a joint session with Governor Connally addressing the group, and indicating he had called the governing legislative bodies together for no other legislative matters other than the voters registration.

Representative Gene Fondren of Taylor, Texas introduced a bill which was referred to the state affairs committee, of which Representative Clayton is a member. A hearing on the new bill, Bill Clayton said, was set for Wednesday (yesterday). It will require two-thirds of the total votes to put the bill into effect, and it is indicated that 104 or 105 legislators will vote for the bill which has 84 co-sponsors of the bill. The bill provides for an annual registration with no fees.

The registration dates will conform with the same dates Texans now pay their poll tax. There is however a temporary arrangement made for those who did not pay poll tax this year. This 15 day period will be sometime during the month of March.

Clayton went on to disclose the fact that this piece of legislation depended on two factors. First, he explained, "The Attorney General, Waggoner Carr was appealing the Federal Court's decision, to do away with poll tax, to the Supreme Court. If the Supreme Court should uphold the lower courts decision, then the bill would become effective. The remaining factor was that should the majority of Texan vote in the November election to abolish poll tax, the bill would then become effective, Representative Clayton said,

Center Nets Near \$45

Saturday was a busy day for those who worked at the Good Will Center. Approximately \$45 was netted, which was the most money made in one day at the newly organized center.

The Springlake Home Demonstration Club was in charge of tending the center. Mrs. Hilbert Wisian reported that a large number of customers came in, and they expressed how nice the merchandise was.

The center is still in need of all kinds of bedding such as blankets, sheets, bedspreads, pillows, and pillowcases. Also it is in great demand of children's pajamas, coats, and shoes. However all useable items will be much appreciated.

It was reported that most of the pots and pans and dishes have been sold. Anyone having these or any other items they would like to donate may contact any PTA member or any representative of the Good Will Center, which is located in the former Earth News-Sun Building, adjacent to the Earth Theater.

Those assisting in the center Saturday were Mrs. J. B. Eagle, Mrs. Edna McClure, Mrs. T. V. Murrell, Mrs. Hilbert Wisian,

Mrs. Lackey, and Mrs. R. W. Fanning. The center will again be open this Saturday from 1 p. m. to 7:30 p. m.

Local Band Selling Candy

The 83 members of the Springlake-Earth band are sponsoring a candy sale, which will continue through Friday of this week.

The 83 members were each given five boxes of candy to sell. This is Masons candy and comes in chocolate almond, and caramel flavors. Anyone not contacted by a band member and wishes to purchase some of this candy, may do so by calling any band member or Dean Foshee, band instructor.

The proceeds from this sale will be used to provide funds for the band trip to Shamrock on March 17, where the local band will compete in a playing and marching contest.

Congressman Rogers Schedules Meeting in District Cities

Congressman Walter Rogers, a veteran of eight terms in the U. S. House of Representatives and second ranking majority member on the House Committee on Interstate and Foreign Commerce, will be honored at a Community Center reception, Monday February 21 at 7 p. m. in the community center in Littlefield.

This reception being held to give the people of the Lamb County area an opportunity to meet and get acquainted with the Congressman, who if the redistricting holds up, will be the Congressman for this area, as Lamb and Bailey Counties move into the 19th Congressional District.

The Congressman, chairman of the Subcommittee on Irrigation and Reclamation will be making his second trip to the area since the redistricting became effective. This will, however, be the first trip that will allow him to visit with the people of the area, and become better acquainted with their problems.

"I am looking forward to discussing first-hand with residents of the 18th Congressional District the problems now facing the Congress in this new Session," Congressman Rogers said. "Of course, the Viet Nam war is of primary importance, but in addition there are a number of questions before Congress concerning agriculture and the Nation's economy generally, as well as the 1966 legislative program."

Congressman Rogers plans to return to Washington February 23 in time for the resumption of hearings February 24 aimed at pin-pointing the cause of recent electric power blackouts in the Northeastern United States and elsewhere. The Congressman was appointed chairman of the special sub-committee to conduct the House of Representatives' investigation of the power failures and to make recommendations.

Before leaving for Texas, Congressman Rogers will preside Monday and Tuesday when his Subcommittee on Irrigation and Reclamation will hold hearings on water resources expansion

legislation and on the saline water program. In making the announcement of the reception, the Democratic Women said this would not be a partisan meeting, it is open to the public, and they hope that people will take this opportunity to become better acquainted with the Congressman.

This meeting is for the entire county and delegations are expected from each community in the county.

Sunnyside News

The rehearsal supper was held in the Odd Fellows Hall in Hereford for the wedding party Friday night. Mr. and Mrs. Ezell Sadler and Mrs. Larry Sadler served the meal.

Mr. and Mrs. Calvin Lippard and Mr. and Mrs. John Gilbreath attended the Plains Memorial Hospital Auxiliary Annual Awards Banquet in Dimmitt Saturday night. Mrs. Lippard introduced the guest speaker. She also received her 200 hour bar for her pin which signifies 300 hours of work given. Mrs. E. R. Sadler and Mrs. L. B. Bowden both have earned the 100 hour pin but were not present to receive them.

Johnnie Ruth Holcomb attended the Young People Valentine Banquet at the First Baptist Church in Dimmitt Saturday night. She also had a part on the program.

Mr. and Mrs. Earl Phelan were supper guests Saturday night of Mr. and Mrs. Noah Spencer and family. They spent Saturday night and Sunday with Mr. and Mrs. Roy Phelan. They also attended the Sunday morning services.

Mr. and Mrs. Bill Smith and Linda and Mr. and Mrs. Clyde Akers and Kenny of Lubbock visited Saturday and Sunday with their parents, Mr. and Mrs. John Spencer. Kenny also attended the Sunday morning ser-



THE QUARTET FROM WAYLAND BAPTIST COLLEGE who provided special music Saturday night at the Best Beau Banquet included Duane Harris, Phil and Mark Langley, and David McGinnis.

Thirteen attended the Association G. A. meeting in Springlake Saturday. Mrs. M. D. Durham, Association G. A. Director was in charge of the meeting. Ann Spencer, who is the Association Prayer Chairman had charge of the Prayer Time. She also sang a special with Reba Hall of Frio.

Mr. and Mrs. Raymond Lilley visited with Mr. and Mrs. Raymond Lewis and family of Olton Saturday, and took Karen shopping for a birthday gift. Mr. and Mrs. Calvin Lippard and Dana visited in Tulia Sunday with her parents, Mr. and Mrs. Frank Soeathen.

Terry Crisp, Naomi Carr, Debbie Curtis, Marsha and Joan Dawson, and Ken Dawson attended the FHA and Vocational Aicultura Banquet at the Springlake-Earth School Saturday night. Denise Morgan helped with the serving.

Ivey Jean Carr and a school friend, Shirley Turner, were home from business college in Lubbock Saturday and Sunday. Several men of the community received subpoenas this week as character witnesses for Ben Derrick whose trial begins Monday.

Ninety attended Sunday School with 64 in Training Union Sun-

(Continued from page 1)

clerks named were Marshall Kelley and P. A. Washington. Polls will be open from 7 a. m. to 7 p. m.

The five remaining school board members are James Busby, Roy Byers, Guy Francis Kelley, Roger Haberer and Bob Armstrong.

The group approved Charles Holt as the new high school science teacher, replacing Mrs. Gladys McCaskill who is now instructing a remedial reading class in the elementary grades. Mr. Holt has a Master's Degree in Biology, and has had five years of teaching experience. Superintendent Bill Mann was authorized to enter into a two year contract with the three Springlake-Earth principals, D. H. Koeninger, Cecil Slover, and J. J. Davis.

The Board approved the secur-

WHEN YOUR DOCTOR HANDS YOUR PRESCRIPTIONS TO YOU, DON'T STOP UNTIL YOU GET TO POUNDS PHARMACY IN EARTH. 2/3/4tc.

Local Students Enter Band Competition

Several of the members from the Springlake-Earth band will participate in the region one, intercollegiate league in Lubbock on Saturday.

The following students will enter the solo contest: Joan Dawson on the oboe, Gary Bullis and Randy Clayton on the bass, Gary Kelley and Danny Haberer on the cornet, Anita O'Hair on the tenor saxophone, Harley Calloway on the trombone, and Mike Cowley on the flute.

There will be quite a large number of ensembles. The group voted to provide the additional financing needed to purchase a new FFA pickup. Other financing will be provided from the funds derived from a recent agricultural sale.

The current enrollment for the school is 950 as compared to 1060 or 1065 in December. The loss of these students was termed a result of the new farm program.

A report on the delinquent tax roll was read, with a decision reached to turn over two suits to the attorney for collection.

Services Held For Kin Of Local Resident

Raymond K. Thompson, 64, a resident of Olton and former resident of Earth, died Friday, February 11 at 11 p. m. in the John Sealey Hospital in Houston. He had been ill for over a month.

Funeral services were held Tuesday, February 15, at 2:30 p. m. in the Sparkman Funeral Chapel in the Oakcliff Addition in Dallas.

He is survived by his wife; two daughters, both of Dallas, three sons, Frank and Joe, both in Viet Nam, and Bill, Dallas; two step daughters, Mrs. Don Taylor, Earth and Mrs. Retha Crowther, Shallowater; one stepson, Gary Lee Provence, Highland, California; 13 grandchildren; one sister; and three brothers.

Interment was in the Oakcliff Cemetery.

Mr. and Mrs. Tom Brown, Lubbock, were guests Sunday in the home of Mrs. Brown's grandparents, Mr. and Mrs. R. C. Hyde.

Mrs. Minnie Price and Mrs. Lucille Price shopped in Plainview on Monday.

Weekend guests in the home of Mr. and Mrs. F. E. Clayton were Mr. and Mrs. V. E. Simmons, Riverside, California.

Layman's Banquet Set For Friday

Dr. Paul Bumpers, pastor of the First Methodist Church, Lubbock, will be the guest speaker at the annual district Layman's banquet which is scheduled to be held at the First Methodist Church, Plainview, at 7 p. m. Friday night.

All men of the local Methodist Church are cordially invited to attend, as this is always one of the highlights in the layman's activities throughout the year.

Bruce Bridges Wins Ribbons In El Paso Show

Bruce Bridges, son of Mr. and Mrs. John Bridges, recently won fourth place ribbons in the Heavy weight Southdown Division at the livestock showing in El Paso.

Bruce's lamb, whose name is Satin, placed fifth in the Dallas State Fair in October, and again placed fifth in the International Livestock showing in early November. Accompanying Bruce to El Paso was his father, John.

HIGH PLAINS TAILWATER PUMP



Salvage Your Waste Water!

Save Your Money!

The Peerless Tailwater Pump is especially designed to economically reclaim water now going to waste on your irrigation land.

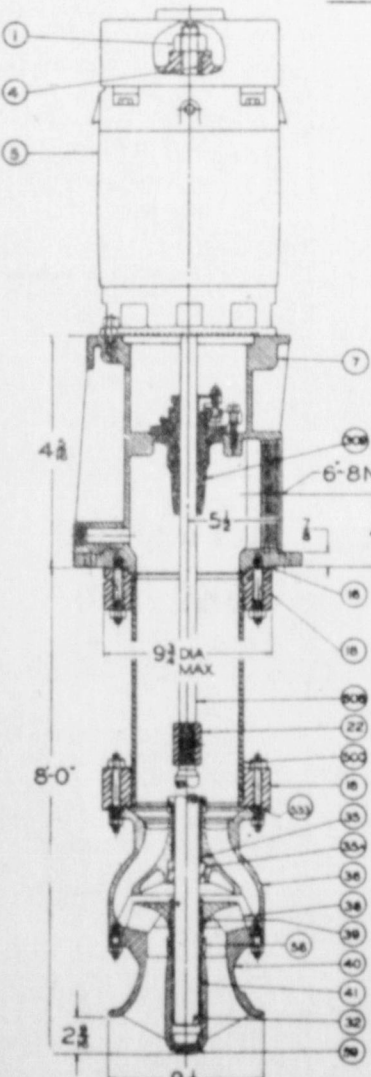

ITEM NO.	DESCRIPTION
1	Nut, Top Shaft
4	Key, GIB
5	Motor, Driver
7	Head, Discharge
16	Gasket, Head
18	Flange, Top Column
22	Coupling, Shaft
32	Shaft, Impeller
35	Bearing, Std.
35A	Bearing, Std.
36	Bowl, Neoprene
38	Bowl, Standard
39	Impeller, Semi-open
40	Bushing, Impeller
41	Taper Lock
41	Manifold, Bell
41	Type Suction
58	Bearing, Suction
58	Manifold
58	Collar, Sand
59	Plug, Suction
309	Manifold
500	Container, Packing
500	Assembly
533	Column, Flanged
608	Gasket, Bowl
608	Shaft, O.L.S. Top

LOOK AT THESE FEATURES:

- Heavy Duty Cast Iron Discharge Head
- High Strength Stainless Steel Shaft
- Dual Bronze and Neoprene Bearings
- Open Type Impeller
- Easy, Quick Adjustment

GIVING YOU THESE BENEFITS:

- Rigid Frame—Longer Bearing Life
- Longer Life—No Rusting Out
- Resists Wear and Abrasion
- Handles Grit and Abrasives
- Assures Highest Performance

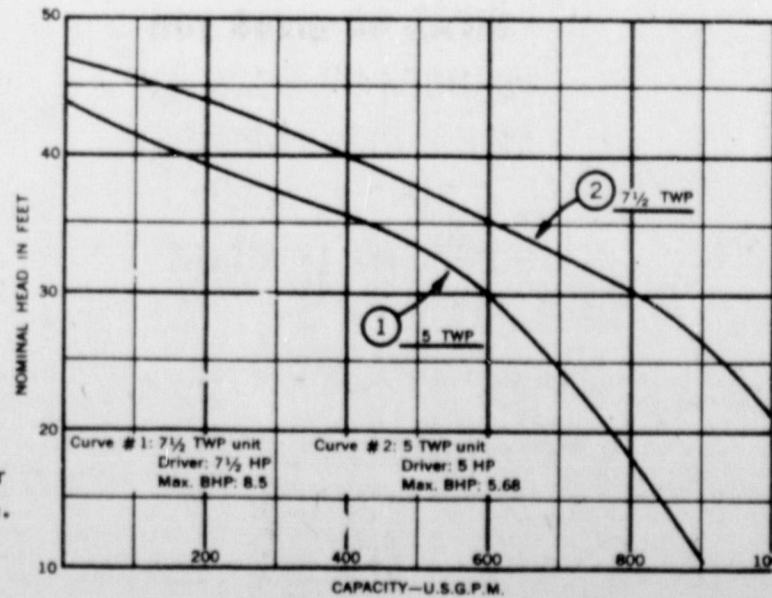

ALSO AVAILABLE Larger models - 10 HP and 15 HP - for combination lake or tailwater service.



PEERLESS PUMPS
Muleshoe, Texas-Phone 272-3242

Get this famous quality table now at an unheard of low price!

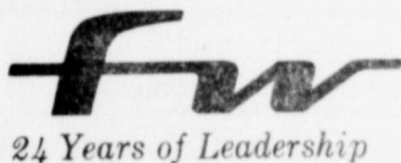

BIG 7 ft. FAMILY HOME POOL TABLE

THE JUPITER SERIES

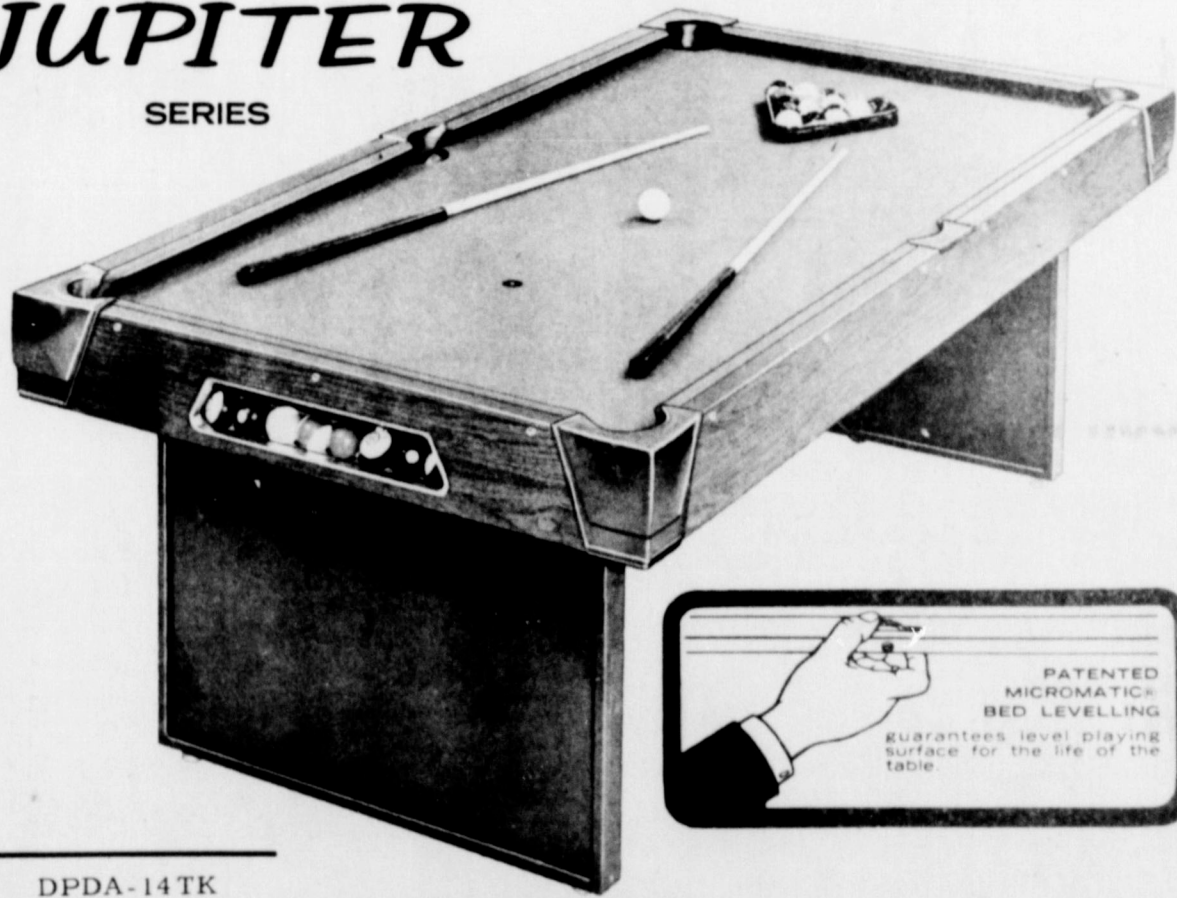

DPDA-14TK
Frost Proof
REF. FRIGIDAIRE
\$349.95 W.T.
THIS PRICE INCLUDES
\$149.95 VALUE
POOL TABLE

- SPECIFICATIONS — All Models**
- ★ MICROMATIC patented bed levellers at 8 points
 - ★ 3/8" bed reinforced with braces
 - ★ Double panelled pedestal legs fold for storage
 - ★ Adjustable leg levellers
 - ★ Finest green cotton suede billiard cloth
 - ★ 100% pure gum rubber cushions
 - ★ Automatic ball returns
 - ★ Side frame finished in scratch resistant walnut Durapanel — laminated to Douglas Fir Plywood
 - ★ Metal top rail trim
 - ★ Tubular diagonal braces to legs
 - ★ Full deflector hi-impact pocket liners
 - ★ Packed in approved carton with full perimeter padding

DAK DELUXE FRIGIDAIRE DRYER
Porcelain Tub
12 Lb. Load
\$189.95 W.T.
Price includes
\$149.95 VALUE
POOL TABLE
Muleshoe

FRIGIDAIRE WASHER
2 SPEED WCDK CUSTOM
DELUXE MOTOR — PUMP — ROLLER-MATIC MECHANISM. 5 YEAR WARRANTY. NO OIL TO SPILL
NO BELTS — NO GEARS — NO PULLEYS — JET ACTION AGITATION — ELIMINATES TANGLING **\$299.95 W.T.**
PRICE INCLUDES \$149.95 VALUE POOL TABLE

HARVEY BASS APPLIANCE

The EARTH NEWS-SUN



Published at Earth, Texas 79031 every Thursday except the first Thursday following Christmas.

Entered as Second Class Matter at the Post Office at Earth, Texas 79031, October 1, 1954--Under Act of Congress March 3, 1879.

SUBSCRIPTION RATE

Earth and Trade Territory, per year..... \$9.50
Elsewhere in United States, Per year..... \$5.00

CLASSIFIED RATES

6¢ per word, first insertion, 5¢ per word thereafter-----60¢ Minimum.

ADVERTISING RATES GIVEN ON REQUEST

ROSS AND POLLY MIDDLETON-----Publishers

Local Boys Enter Lamb County Livestock Show

Over 180 entries have been received for the Lamb County Junior Livestock Show which will be held in Littlefield Friday and Saturday, February 18 and 19.

The entry list is expected to grow considerably as the Olton entries had not yet been received by the Extension Service Office, and in former years the boys and girls in the Olton area have entered many animals in the show.

The final total entry list is expected to be near that of last year, when a total of 292 animals were entered in the two-day show. The number of lamb entries is expected to reach a figure over that of last year when a total of 82 were entered.

The final entry total for calves is expected to be near that of last year when 56 entries were received but a decrease is probable in the number of swine entered as the total for last year was 154 and not over 110 to 120 are expected this year.

Approximately \$750 in prizes will be distributed as premiums as Littlefield and Olton have guaranteed \$200 each; Amherst, Sudan, and Earth-Springlake \$100 each and Spade 50 dollars.

In addition, the Grand Champion and Reserve Champion Steer and Reserve Champion Swine and four lamb class champions will receive trophies.

There will be divisions for steers in the Hereford class and the Angus and other breed class. In the lamb judging there will

be four classes, fine wool, medium wool, Southdown and animals showing evidence of Southdown breeding and Shropshires and the fourth class will be cross breed fine and medium wool.

Sifting will start at 1:30 p. m. Friday afternoon with the lamb judging starting at 5:30 Friday evening.

Judging of barrows will start at 9 a. m. Saturday morning with the steer judging scheduled to start at one Saturday afternoon.

FFA members entering the show from the local school are as follows: Dwayne Montgomery, two Hampshire barrows, Jerry Anderson, one Hampshire barrow, Lonnie Dear, two Hampshire barrows, Jerry Townsend, one Hampshire Barrow, Jimmie Alair, one Hampshire barrow and one Hampshire lamb, Bob Coker, one Hampshire barrow, Bob Phillips, two Poland China barrows, Steve Jackson, one Berkshire barrow, Ken Dawson, one Berkshire barrow, Bill Gover, one Duroc Barrow, Gady Johnson, one Duroc Barrow and one chester white barrow, Randy Washington, one Duroc Barrow, Billie Lanier, one chester white barrow, David Foster, one cross-breed barrow, Bryan Hamilton, one Angus steer and one Hampshire lamb, David Templeton, one angus steer, Perry Don O'Hair, one angus steer, and Lonnie Dear, one steer, one Southdown lamb, and one fine wool lamb.

According to Ronnie McNutt, assistant County Agent, Little-

Sunnyside News

by Teeny Bowden

Mr. and Mrs. James Powell, Randy, Tresa Denae and Cheryl visited last Sunday with Mr. and Mrs. Woodrow Powe 1 of Earth and other members of the family. Cheryl went home with Mr. and Mrs. Glenn Harvey of Lubbock and stayed until Wednesday night when they brought her home.

Mrs. L. B. Bowden and Mrs. E. R. Sadler worked at Plains Memorial Hospital Monday afternoon in the library and at the desk and gift shop.

Monday afternoon to make arrangements for the Hospital Auxiliary Annual Awards Banquet.

A trace of rain was received Tuesday morning with small hail almost covering the ground right in Sunnyside. Light snow flurries fell most of the day Friday melting as it fell. Lighter flurries fell Sunday and some freezing drizzle accumulated.

Mr. and Mrs. Garner Ball and family of Olton were dinner guests last Sunday of Mr. and Mrs. J. Paul Waggoner, Jimmy, and Mrs. Mickey Waggoner, who arrived last Wednesday to visit awhile with them. Their plans to visit Mickey over this week-end were canceled when Lackland Air Force Base was isolated because of the outbreak of spinal meningitis.

The Brotherhood met Tuesday night with twelve attending. Roy Phelan had charge of the program, Cake and ice cream were served after the meeting.

Mr. and Mrs. Odell James returned home Wednesday night after spending a week at their place at Vinita, Oklahoma.

Mrs. Calvin Lippard attended the Hospital Auxiliary Executive meeting and business meeting in the First Methodist Church in Dimmitt Wednesday morning.

The WMS met Wednesday night for the General Missionary program. Mrs. Roy Phelan had charge of the program. Nine member were present.

Twenty seven attended the Church Youth Valentine supper Thursday night. The YWA girls had charge of the program. It was a progressive supper with the salad representing Sweden served at the home of Mr. and Mrs. Robert Bridge, the main course- Italian spaghetti-at the Weldon Bradley home, and the dessert, home made ice cream representing Hawaii at the church.

Mrs. Wanda Newberry is Superintendent, the following 4-H members will exhibit animals: Leland Dear, one fine wool lamb, Bruce Bridges, one Southdown lamb and cross-breed lamb, Kregg and Welda Barton, Hereford steers, David Templeton, one angus steer, and Ken Sanderson, one Berkshire pig.

intendent of the Intermediate and Young People Department of the Sunday School, Barbara Elliott was M. C. for the program. Rev. T. J. Ozburn of Wayland was the guest speaker, Glenn Wilson acted as the Pilot, Lonnie Follissang a solo, Molly and Lee Bradley put on a skit, Ann Spencer was crowned the Queen, Gene Carson was crowned King.

The Pilot and those who served were dressed as airline pilot and stewardesses. The inside of the fellowship hall was decorated like the inside of an airplane.

Mokey Ivey and Mary Perska of Dimmitt were married in the Northside Baptist Mission in Dimmitt Friday night. Eddie Waggoner served as Best Man, Dounie Lilley as Groomsman, Deanna Morgan was the Maid of Honor. Sue Gee was the bridesmaid.

Mr. and Mrs. Floyd Ivey, Mr. and Mrs. Curtis Pruitt and Judy of Midland, Mr. and Mrs. Cecil Lawrence of Dallas, Mrs. E. W. Barnard and Mr. and Mrs. Joe B. Barnard of Amarillo, Mr. and Mrs. Raymond Lilley, Mrs. J. T. Holcomb, Butch and Barbara Elliott were among those attending the ceremony.

Mr. and Mrs. Curtis Pruitt and Judy spent Friday night with Mr. and Mrs. Floyd Ivey. Mrs. Barnard is Mrs. Ivey's sister, Joe Bill Barnard and Cecil Lawrence are her nephews.

After a honeymoon in New Mexico and possibly points of interest in Colorado they will make their home in Dimmitt.

The rehearsal supper for the wedding party was given at the Colonial Inn Thursday night.

Mr. and Mrs. Gale Sadler, Cindy and Susan of Southard, Oklahoma arrived Friday evening to spend the week-end with Mr. and Mrs. E. R. Sadler, and attend the wedding of David Sadler. They attended the Sunday morning services.

Ben Ray Holcomb of Dimmitt spent Friday night with his grandparents, Mr. and Mrs. J. T. Holcomb and children.

Mr. and Mrs. Robert Paschal, Janie and Keith of Wingate arrived Saturday to visit with friends and relatives to attend David Sadler's wedding. They visited Saturday with the E. R. Sadler family, spent Saturday night with the Ezell Sadlers and attended the Sunday morning church services.

David Sadler and Gay King of Hereford were married in a double ring ceremony in the First Methodist Church in Hereford Saturday afternoon.

Kenneth Presley of Dimmitt served as Best Man, Jerry Walker of Dimmitt as Groomsman, Jerri Chase of Amarillo was the Bridesmaid, Carolyn Palmer of Hereford was the Maid of Honor, Carl King, the bride's brother served as ring bearer, her sister, Brenda King served as Flower girl. Her brother, Bobby King, and Larry Sadler served as ushers and candle lighters.

The reception was in the fellowship hall of the church.

After a honeymoon in Carlsbad, and other points of interest in New Mexico, they will make their home in the community.

Mrs. Pearl Sadler of Dimmitt, Mr. and Mrs. Bayrd Sadler of Tulsa, Mr. and Mrs. Ezell Sadler, Mrs. Larry Sadler, Mr. and Mrs. James Powell and children, and his parents, Mr. and Mrs. Woodrow Powell of Earth, Mr. and Mrs. E. R. Sadler, Mr. and Mrs. Gale Sadler and girls from Southard, Oklahoma, Mr. and Mrs. Robert Paschal and children of Wingate, Mr. and Mrs. Alton Louder, Mr. and Mrs. L. B. Bowden, Mrs. J. T. Holcomb, Mrs. Weldon Bradley, and Barbara Elliott attended the ceremony.

Mrs. Pearl Sadler fixed supper Saturday night for the relatives who had attended the wedding.

Mr. and Mrs. James Powell, Randy, Tresa Denae and Cheryl visited last Sunday with Mr. and Mrs. Woodrow Powe 1 of Earth and other members of the family. Cheryl went home with Mr. and Mrs. Glenn Harvey of Lubbock and stayed until Wednesday night when they brought her home.

Mrs. L. B. Bowden and Mrs. E. R. Sadler worked at Plains Memorial Hospital Monday afternoon in the library and at the desk and gift shop.

Monday afternoon to make arrangements for the Hospital Auxiliary Annual Awards Banquet.

A trace of rain was received Tuesday morning with small hail almost covering the ground right in Sunnyside. Light snow flurries fell most of the day Friday melting as it fell. Lighter flurries fell Sunday and some freezing drizzle accumulated.

Mr. and Mrs. Garner Ball and family of Olton were dinner guests last Sunday of Mr. and Mrs. J. Paul Waggoner, Jimmy, and Mrs. Mickey Waggoner, who arrived last Wednesday to visit awhile with them. Their plans to visit Mickey over this week-end were canceled when Lackland Air Force Base was isolated because of the outbreak of spinal meningitis.

The Brotherhood met Tuesday night with twelve attending. Roy Phelan had charge of the program, Cake and ice cream were served after the meeting.

Mr. and Mrs. Odell James returned home Wednesday night after spending a week at their place at Vinita, Oklahoma.

Mrs. Calvin Lippard attended the Hospital Auxiliary Executive meeting and business meeting in the First Methodist Church in Dimmitt Wednesday morning.

The WMS met Wednesday night for the General Missionary program. Mrs. Roy Phelan had charge of the program. Nine member were present.

Twenty seven attended the Church Youth Valentine supper Thursday night. The YWA girls had charge of the program. It was a progressive supper with the salad representing Sweden served at the home of Mr. and Mrs. Robert Bridge, the main course- Italian spaghetti-at the Weldon Bradley home, and the dessert, home made ice cream representing Hawaii at the church.

Mrs. Wanda Newberry is Superintendent, the following 4-H members will exhibit animals: Leland Dear, one fine wool lamb, Bruce Bridges, one Southdown lamb and cross-breed lamb, Kregg and Welda Barton, Hereford steers, David Templeton, one angus steer, and Ken Sanderson, one Berkshire pig.

Mr. and Mrs. James Powell, Randy, Tresa Denae and Cheryl visited last Sunday with Mr. and Mrs. Woodrow Powe 1 of Earth and other members of the family. Cheryl went home with Mr. and Mrs. Glenn Harvey of Lubbock and stayed until Wednesday night when they brought her home.

Mrs. L. B. Bowden and Mrs. E. R. Sadler worked at Plains Memorial Hospital Monday afternoon in the library and at the desk and gift shop.

Monday afternoon to make arrangements for the Hospital Auxiliary Annual Awards Banquet.

A trace of rain was received Tuesday morning with small hail almost covering the ground right in Sunnyside. Light snow flurries fell most of the day Friday melting as it fell. Lighter flurries fell Sunday and some freezing drizzle accumulated.

Mr. and Mrs. Garner Ball and family of Olton were dinner guests last Sunday of Mr. and Mrs. J. Paul Waggoner, Jimmy, and Mrs. Mickey Waggoner, who arrived last Wednesday to visit awhile with them. Their plans to visit Mickey over this week-end were canceled when Lackland Air Force Base was isolated because of the outbreak of spinal meningitis.

The Brotherhood met Tuesday night with twelve attending. Roy Phelan had charge of the program, Cake and ice cream were served after the meeting.

Mr. and Mrs. Odell James returned home Wednesday night after spending a week at their place at Vinita, Oklahoma.

Mrs. Calvin Lippard attended the Hospital Auxiliary Executive meeting and business meeting in the First Methodist Church in Dimmitt Wednesday morning.

The WMS met Wednesday night for the General Missionary program. Mrs. Roy Phelan had charge of the program. Nine member were present.

Twenty seven attended the Church Youth Valentine supper Thursday night. The YWA girls had charge of the program. It was a progressive supper with the salad representing Sweden served at the home of Mr. and Mrs. Robert Bridge, the main course- Italian spaghetti-at the Weldon Bradley home, and the dessert, home made ice cream representing Hawaii at the church.

Mrs. Wanda Newberry is Superintendent, the following 4-H members will exhibit animals: Leland Dear, one fine wool lamb, Bruce Bridges, one Southdown lamb and cross-breed lamb, Kregg and Welda Barton, Hereford steers, David Templeton, one angus steer, and Ken Sanderson, one Berkshire pig.

Mr. and Mrs. James Powell, Randy, Tresa Denae and Cheryl visited last Sunday with Mr. and Mrs. Woodrow Powe 1 of Earth and other members of the family. Cheryl went home with Mr. and Mrs. Glenn Harvey of Lubbock and stayed until Wednesday night when they brought her home.

Mrs. L. B. Bowden and Mrs. E. R. Sadler worked at Plains Memorial Hospital Monday afternoon in the library and at the desk and gift shop.

Monday afternoon to make arrangements for the Hospital Auxiliary Annual Awards Banquet.

A trace of rain was received Tuesday morning with small hail almost covering the ground right in Sunnyside. Light snow flurries fell most of the day Friday melting as it fell. Lighter flurries fell Sunday and some freezing drizzle accumulated.

Mr. and Mrs. Garner Ball and family of Olton were dinner guests last Sunday of Mr. and Mrs. J. Paul Waggoner, Jimmy, and Mrs. Mickey Waggoner, who arrived last Wednesday to visit awhile with them. Their plans to visit Mickey over this week-end were canceled when Lackland Air Force Base was isolated because of the outbreak of spinal meningitis.

The Brotherhood met Tuesday night with twelve attending. Roy Phelan had charge of the program, Cake and ice cream were served after the meeting.

Mr. and Mrs. Odell James returned home Wednesday night after spending a week at their place at Vinita, Oklahoma.

Mrs. Calvin Lippard attended the Hospital Auxiliary Executive meeting and business meeting in the First Methodist Church in Dimmitt Wednesday morning.

The WMS met Wednesday night for the General Missionary program. Mrs. Roy Phelan had charge of the program. Nine member were present.

Twenty seven attended the Church Youth Valentine supper Thursday night. The YWA girls had charge of the program. It was a progressive supper with the salad representing Sweden served at the home of Mr. and Mrs. Robert Bridge, the main course- Italian spaghetti-at the Weldon Bradley home, and the dessert, home made ice cream representing Hawaii at the church.

Mrs. Wanda Newberry is Superintendent, the following 4-H members will exhibit animals: Leland Dear, one fine wool lamb, Bruce Bridges, one Southdown lamb and cross-breed lamb, Kregg and Welda Barton, Hereford steers, David Templeton, one angus steer, and Ken Sanderson, one Berkshire pig.

Mr. and Mrs. James Powell, Randy, Tresa Denae and Cheryl visited last Sunday with Mr. and Mrs. Woodrow Powe 1 of Earth and other members of the family. Cheryl went home with Mr. and Mrs. Glenn Harvey of Lubbock and stayed until Wednesday night when they brought her home.

Mrs. L. B. Bowden and Mrs. E. R. Sadler worked at Plains Memorial Hospital Monday afternoon in the library and at the desk and gift shop.

Monday afternoon to make arrangements for the Hospital Auxiliary Annual Awards Banquet.

A trace of rain was received Tuesday morning with small hail almost covering the ground right in Sunnyside. Light snow flurries fell most of the day Friday melting as it fell. Lighter flurries fell Sunday and some freezing drizzle accumulated.

Mr. and Mrs. Garner Ball and family of Olton were dinner guests last Sunday of Mr. and Mrs. J. Paul Waggoner, Jimmy, and Mrs. Mickey Waggoner, who arrived last Wednesday to visit awhile with them. Their plans to visit Mickey over this week-end were canceled when Lackland Air Force Base was isolated because of the outbreak of spinal meningitis.

The Brotherhood met Tuesday night with twelve attending. Roy Phelan had charge of the program, Cake and ice cream were served after the meeting.

Mr. and Mrs. Odell James returned home Wednesday night after spending a week at their place at Vinita, Oklahoma.

Mrs. Calvin Lippard attended the Hospital Auxiliary Executive meeting and business meeting in the First Methodist Church in Dimmitt Wednesday morning.

The WMS met Wednesday night for the General Missionary program. Mrs. Roy Phelan had charge of the program. Nine member were present.

Twenty seven attended the Church Youth Valentine supper Thursday night. The YWA girls had charge of the program. It was a progressive supper with the salad representing Sweden served at the home of Mr. and Mrs. Robert Bridge, the main course- Italian spaghetti-at the Weldon Bradley home, and the dessert, home made ice cream representing Hawaii at the church.

Mrs. Wanda Newberry is Superintendent, the following 4-H members will exhibit animals: Leland Dear, one fine wool lamb, Bruce Bridges, one Southdown lamb and cross-breed lamb, Kregg and Welda Barton, Hereford steers, David Templeton, one angus steer, and Ken Sanderson, one Berkshire pig.

FHA Chapter Views Film On Drop-Outs

The local FHA met Monday night at 6 p. m. in the high school auditorium to see the film entitled, "When I'm old Enough, Good-bye."

A representative from the Texas Employment Commission in Littlefield showed this very inspiring film to the approximately 45 FHA members attending.

Following the film, refreshments of punch and cookies were served by Terri Crisp, Dwala Boone, Linda Jordan, and Kathy Seiter in the home economics room.

Mrs. Calvin Lippard visited in Amarillo with Mother Angela Claire of Saint Anthony Hospital.

FAST PRESCRIPTION SERVICE

IF WE HAVE NOT STOCKED THE MEDICATION YOUR DOCTOR PRESCRIBED, POUNDS PHARMACY WILL GET IT TO YOU WITHIN ONE HOUR.

2/3/4tc.

Jamey Beene Involved In Auto Mishap

No injuries were sustained in an accident Monday night that resulted in the total destruction of a 64 Pontiac on the farm-to-market road 1055, 9 miles North of Earth.

The accident occurred, according to Jamey Beene, owner-manager of the Sunnyside Food Store, after he momentarily fell asleep at the wheel of his car about midnight, veering off the road and into a field belonging to the old Fry Ranch. Sparks from the auto apparently caught the grass on fire which resulted in igniting the car.

The Earth Volunteer Fire Department answered the call. The Highway Patrolmen from Dimmitt investigated the accident, rendering no ticket, according to Beene.

'66 AUTO TAGS SELLING SLOW LY

Mrs. Ruby Anderson, City Secretary, reported Tuesday afternoon that the '1966 license tag sale has slowed down considerably in the last week.

The deadline for purchasing your '1966 license tags for all vehicles is April 1.

State law requires that you must present your title and license receipts in order to purchase your new license.

Get your '1966 tags for cars, trucks, pickups, and farm vehicles today at the City Hall.

PARTY LINE

Mr. and Mrs. Ray Tom Packard, Levelland, were visitors Sunday in the homes of Mr. and Mrs. James Packard and Mr. and Mrs. Carl Cody.

Mrs. S. C. Beavers and Mrs. H. S. Sanders attended the show "The Sound of Music" in Lubbock on Wednesday.

Mr. and Mrs. Clarence Goodwin, Amarillo, visited Sunday afternoon in the home of Mr. and Mrs. M. R. Burton.

Mr. and Mrs. James Glasscock, Melrose, N.M., were guests Sunday night in the L. A. Glasscock home.

Bitner To Construct Home In Hite Park Addition

Jimmy Bitner, owner-manager of Bitner Tire and Supply, will in the very near future, begin construction of a three bedroom, two bath home. This home will be located on lot 42, just East of the Joe Temple home in Hite Park Addition.

Bitner reported that this will be a brick veneer structure, and should be completed in approximately 60 days after work is begun, if weather permits.

Weekend guests in the home of Mr. and Mrs. V. T. Gooch, were Mr. and Mrs. Jack Seay and daughter, Lubbock.

Local Residents Move to Waxahachie

Dub Merck, former manager of Barton Bros. Gin Company for one year, reported Tuesday that he and his family are moving to Waxahachie, the latter part of this week.

Merck has purchased a gin at Red Oak, where he will be owner-manager.

Mr. and Mrs. Merck are the parents of four children, Dubra age 11, Bobby age 10, Brenda age 8, and Danny, age 5.

PARTY LINE

Mike Green, son of Mr. and Mrs. Terry Green, Lubbock, is spending a few days with his grandmother, Mrs. Bonnie Green.

My Neighbors



"Automated date maker—as the girls go by, select your number, press the pedal and 'kapow!'"

SPECIAL OF THE WEEK

By George-
We Are
FIRST
IN
VALUES

VALUES
to
\$5.98
for only
22¢

ON GEORGE'S BIRTHDAY FEBRUARY 22

CHECK FOR THESE SPECIALS THROUGHOUT THE STORE...

BEN FRANKLIN STORE

128 Main St. Muleshoe, Texas

Get 1/3 More!

NIPAK 45 gives you 1/3 more nitrogen per pound than any other form of solid nitrogen fertilizer

Get better wheat crops and earn bigger profits. Topdress your wheat with NIPAK 45 right now—for greater yield and higher protein. NIPAK 45 gives you one third more nitrogen per pound than any other form of solid nitrogen fertilizer—which enables you to handle less fertilizer and cover more ground in less time. NIPAK 45 is uniformly prilled, too. It flows easily, won't

cake, clog—or corrode your equipment. NIPAK also dissolves in the soil moisture and moves quickly to the root zone where it stays put until your crops need it. So for more grow power ask your local NIPAK dealer about NIPAK 45. He can help you plan a complete fertilizer program because he can provide a complete fertilizer service. NIPAK—THE BEST 5-LETTER WORD FOR FERTILIZER.

FARM CHEMICAL CO.

EARTH SPRINGLAKE

THE PROFIT TWINS

AMMO-PHOS for GROW POWER

OUR TRUCKS ARE READY TO APPLY THE FINEST IN DRY FERTILIZERS...

AMMO-PHOS MADE ONLY BY OLIN

LET US APPLY AMMO-PHOS NOW AND YOU CAN DISC IN WITH YOUR TREFLAN. AMMO-PHOS CAN HELP YOU MAKE BIGGER YIELDS AND HIGHER PROFITS.

TREFLAN for KILLING POWER

NOW IS THE TIME FOR THE OTHER PROFIT TWIN...

TREFLAN GETS RID OF PROFIT ROBBING WEEDS NOW.

NO WORRY LATER ABOUT HOE HANDS OR WET WEATHER. CUT EXPENSES WITH TREFLAN. LITTLE HOEING, LESS PLOWING, LESS ROOT PRUNING, LESS PACKING OF SOIL, NO PLOWING WHEN TOO WET, MORE PROFITS.

Farm Chemical Co.

257-2301-EARTH SPRINGLAKE-986-2161

Marian Dawson Wins First In Sonatina-Concerto Piano Contest

The Annual Sonatina-Concerto piano contest sponsored by the South Plains Music Association, was held on February 11 and 12 in Lubbock.

A local first place winner in the contest is Marian Dawson, a sixth grade student and daughter of Mr. and Mrs. Ed Dawson. She played "Sonatina in C Major by Mozart, second Movement; and will play in a special program Tuesday, February 22 in Lubbock.

Other local winners were, Jan Cleavinger who placed second. She played "Sonatina in G Major by Schmitt. Jan is the daughter of Mr. and Mrs. O.

M. Cleavinger and is a seventh grade student. Becky Littleton, daughter of Mr. and Mrs. J. A. Littleton, Jr., and a sixth grade student, placed fourth. She played "Sonatina in G Major" by A. Brehl.

The second place winner was Marsha Dawson, who played, "Miniature Concerto," by Alec Rowley. She is a freshman student and the daughter of Mr. and Mrs. Ed Dawson.

These students are piano pupils of Samuel F. Pendleton, Lubbock, who teaches several students in this community.



JILL McCORD AND JOAN DAWSON

Lisa Clayton Honored With Slumber Party

Lisa Clayton, daughter of Mr. and Mrs. Wendell Clayton, was honored on her 9th birthday with a slumber party in her home Friday night.

The girls enjoyed playing games, singing songs, and telling stories. Girls attending the slumber party were Cindy McAlpine, Peggy Gregory, Kim Bamette, and Joy Faver.

On Saturday Mrs. Clayton accompanied the girls to the Olton skating rink. Debra Weil and Janet Britton also enjoyed the skating party with the group.

Girls Visit Rest Home

by Sue Ann Bunner

The Junior Girls' Auxiliary of the First Baptist Church of Springlake went to Muleshoe Wednesday afternoon.

Their regular program was presented to Mrs. Brock and other ladies in the rest home there. The girls also left cookies and Valentine tray cards to be given to all ladies in the home on Valentine Day.

After the program, seven junior girls and their sponsor, Mrs. Francis Watson, ate supper at a Muleshoe restaurant before returning to Springlake.

Local Sorority Selling Cookbooks

The local Beta Sigma Phi Sorority is selling cookbooks which is included in one of their many projects throughout the year.

The cookbook is entitled "Favorite Recipes of Texas Meats," and contains 600 recipes received from the various women's clubs throughout Texas. These are recipes ranging from beef dishes to sea foods and soups of all kinds. There will be four more cookbooks sold by the sorority. Next year they will sell the dessert cookbook, in 1968, the salad cookbook, in 1969, the casserole cookbook, and in 1970, the vegetable cookbook.

These cookbooks are selling for \$1.00 each, and proceeds from this sale will be used to provide funds for projects and various expenses of the club throughout the year.

Anyone wishing to purchase one or more of these cookbooks may do so by contacting any Beta Sigma Phi member or Mrs. Mike Simmons at 257-5691.

Party Line

Jean Sawyer, student at West Texas University, Canyon, visited her parents over the weekend. Mr. and Mrs. Kenneth Sawyer.

Mr. and Mrs. L. T. Smith were Sunday dinner guests in the L. F. Ward home in Post.

Joan Dawson Crowned Miss FHA

Joan Dawson was crowned Miss FHA 1966 at the annual FHA Best Banquet Saturday night in the school cafeteria.

Miss Dawson, the daughter of Mr. and Mrs. Ed Dawson, was crowned by Jill McCord, last year's Miss FHA, before a capacity crowd of FHA members, their beaus, FHA club mother, Mrs. Pat McCord, the chapter mothers, Mrs. E. C. Kelley, Mrs. Lewie Jordan, and Mrs. Gene Brown, the chapter's honorary member, Mr. Belew, associate instructor, Mrs. Evelyn Maxey, and the high school faculty and their husbands and wives.

"Arabian Knights" was the theme so vividly carried out in the lovely decorations. Near the entrance of the room were three red and white striped tents, with huge camels saddled with red saddles on either side of the tents. Yellow balloons and red hats hung from the ceiling above each of the long banquet tables. The tables were laid with lovely white cloths, centered with red and white miniature Arabian tents, red candles, and lace lawn. The place cards and programs symbolized the Arabian Queen and King.

The invocation was given by Randy Washington, followed by Joan Dawson, giving the welcome address. Floyd Bennett

gave the response to the welcome.

The menu consisted of pepper steak, peach halves, cheese baked potatoes, green beans, muffins, butter, North Pole cherry pie, and iced tea.

Waitresses for the occasion were members of the seventh grade class: Susan Parish, Caron Armstrong, Julie Cleavinger, Jenna Banks, Canille Haberer, Elaine Hanson, Roberts Gaston, Caron Koeninger, Sharon Clark, Sandra Henderson, Denise Morgan, and Susie Adrian.

Special entertainment was presented by a quartet from Wayland Baptist College, including Duane Harris, Phil and Mark Lungely, and David McGinnis.

A "first lady" style show was presented by Kathy Clayton, narrator, Karen Jones, Lady Byrd Johnson, Donna Street as Angelica Van Buren, Joan Dawson as Dolly Madison, Melody Brock as Mrs. Johnston, and Dalpha Banks as Mrs. Clay Puke. These girls modeled the dresses that depicted the styles that were worn in the White House at the time of their husbands' presidency.

Janita Blackburn presented playing cards to Randy Washington, Dream Boy, and Floyd Bennett. FHA Buddy, and milk glass candle holders and fruit bowl to Mrs. Cecil Slover, FHA instructor.

Mrs. Cecil Slover made the presentation of red roses to the girls who have been in the FHA for four years. Those receiving roses were Jill McCord, Donna Street, Helen Phillips, Alicia Galloway, Carolyn Kelley, Diane Gregory, and Dwala Boone. She also presented Club mother and chapter mothers

Birthday Party Honors Duet

J. O. Crawford Muleshoe, was surprised with a party in his home on his 75th birthday Tuesday, February 15. Also honored was Jasper Riley, 84, a life long friend of Mr. Crawford. Both men came to the area in a covered wagon in the early 1900s from Oklahoma.

The serving table was covered with a white cloth, centered with a beautiful white birthday cake decorated with pink roses and pink candles on which the words "Happy Birthday," were inscribed.

Mr. Crawford's children who were able to attend were Mr. and Mrs. Doug Ruby, Mrs. Agnes Fry, and Ben Crawford, Littlefield. Grandchildren present were Mrs. Kay Hartman and children and Mrs. James D. Tuelo.

Truelock and children, Mr. Crawford's two sons were unable to attend.

Many gifts were received.

Rylant Pledges To Phi Epsilon Kappa

Arboth Rylant of Earth was one of twenty fall pledges recently initiated into Phi Epsilon Kappa, national physical education fraternity, at West Texas State University in Canyon.

Rylant, son of Mr. and Mrs. W. J. Rylant, was a 1964 graduate of Springlake-Earth School. He is a freshmen student at WTSU, majoring in physical education.

PARTY LINE

Mr. and Mrs. G. L. Adrian and Claude Holder were in Hereford Sunday afternoon visiting Mrs. Adrian's uncle who is ill, J. T. Boynton.

with red roses.

Roses were presented by Jill McCord to the honorary member and assistant advisor.

The group were dismissed following the FHA prayer song which was led by Kathy Clayton, accompanied by Anita O'Hair at the piano.

POUNDS PHARMACY CAN FILL ANY DOCTOR'S PRESCRIPTION HAVE YOUR PRESCRIPTIONS FILLED AT YOUR LOCAL PHARMACY 2/3/4tc.

Jones Home Scene Of WSG Meeting

Members of the Wesleyan Service Guild met on Monday, February 14 in the lovely home

of Ruby Jones. Mrs. B. T. Hamilton began the study on acts with the reading of 1 John 4:20. Following the reading, she reviewed the topics entitled, "An Overall View of the Book of Acts" and "New Life in the Spirit."

Delicious refreshments of dainty crackers, nuts, cherry ice

box pie, and coffee were served by the hostess, Miss Jones, to Mrs. C. T. Richardson, Mrs. Woodrow Powell, Mrs. J. D. Newton, Mrs. Floyd Burgess, Mrs. B. T. Hamilton, and Mrs. Gladys Goodwin.

ADVERTISING PAYS



TRADITIONAL BLACK
\$59.50 \$2.48 per month Plus Sales Tax

TRADITIONAL WHITE
\$59.50 \$2.48 per month Plus Sales Tax

LAWN-GLO WHITE
\$69.50 \$2.89 per month Plus Sales Tax

LAWN-GLO BLACK
\$69.50 \$2.89 per month Plus Sales Tax

YOU CAN HAVE A MODERN ELECTRIC READY-LITE FOR AS LITTLE AS \$248* per month *PLUS SALES TAX

Reddy presents four all new cast-aluminum Ready-Lites designed for long life and lasting beauty. Ready-Lites are completely automatic — on at night — off by day — and come equipped with a weatherproof convenience outlet for your convenience. You may pay for your Ready-Lite on your electric bill and take as long as 24 months to pay. Prices include installation.

See your Public Service Neighbor!



Modern ELECTRIC Lighting

PINKNEY FRANKS 3LB. CELLO 98¢	CENTRAL AMERICAN BANANAS LB. 10¢
FARM PAC. PICNICS SMOKED CURED LB. 49¢	WHITE POTATOES 10LB. BAG 49¢
ROUND STEAK U.S.D.A. CHOICE LB. 98¢	PORTALES YAMS JUMBO LB. 5¢
SHURFRESH MILK GAL. CART 79¢	CLOVERLAKE ASST'D FLAVORS MELLORINE 39¢ GLADIOLA FLOUR 25 LB. PILLOW CASE \$2.29
SHURFRESH BISCUITS 10CT. CAN 5¢	3LB. CAN CRISCO 79¢
GIANT SIZE TIDE 69¢	SHURFINE LB. CAN COFFEE 69¢
BUCANEER COUPONS 5,000 FREE BONUS STAMPS	SHURFINE FROZEN ORANGE 12 OZ CAN JUICE 3 OR \$1.00

SUNNYSIDE FOOD STORE SUNNYSIDE, TEXAS
DOUBLE BUCANEER STAMPS ON WED. WITH \$2.50 PURCHASE OR MORE

We Are Here To Serve You

The Officers and Employees of **PROGRESSIVE**

CITIZENS STATE BANK

EARTH, TEXAS

MEMBER F. D. I. C.

Start Your Account Today:

- CHECKING ACCOUNTS
- TIME SAVINGS ACCOUNTS
- SAFE DEPOSIT BOXES
- BANK BY MAIL
- TRAVELERS CHECKS
- BANK MONEY ORDERS

Loans:

- CROP PRODUCTION LOANS
- AUTOMOBILE LOANS
- COMMERCIAL LOANS
- LIVESTOCK LOANS
- FARM MACHINERY LOANS
- HOME MODERNIZATION LOANS

The EARTH NEWS-SUN Women's Page

Hite Home Scene of Study Club Meeting

The lovely home of Lena Hite was the meeting place for the Town and Country Study Club Thursday afternoon.

Mrs. Jimmy Craft, native of Japan, presented the program, telling of her homeland in a very shrewd manner. She showed movies explaining the customs and habits of her native land as she presented the pictures that were made while in Japan last fall on vacation.

Proceeding the program, Mrs. B. Barnhill told about visiting with Miss Sue Parker, the club's scholarship student who is attending school in Amarillo.

Mrs. H. S. Sanders presented the general federation report on taxes.

Mrs. M. E. Kelley led "The Club Collect."

Mrs. Hite presented inspirational thoughts entitled, "Optimist's Creed," in a very unique manner.

Hearts, cupid, roses, and ribbons carried out the Valentine theme in the entertaining room.

Delicious refreshments of sandwiches, olives, pickles, cake squares, mixed nuts, and coffee were served by the hostess, Mrs. Hite, and co-hostess, Aurelia Sanders.

Attending the meeting were Mrs. John Laing, Mrs. Elsie Hawkins, Mrs. Wayne Rutherford, Mrs. Joe B. Temple, Mrs. L. K. Anderson, Mrs. R. W. McCaskill, Mrs. J. L. Hinson, Mrs. A. C. Barton, Mrs. Carra Morgan, Mrs. Gladys Gill, Mrs. S. C. Beavers, Mrs. Ethel Fry, Mrs. B. Campbell, Mrs. Mrs. Clyde Goodwin, Mrs. Marie Ross, Mrs. C. T. Richardson, Mrs. Lucille Price, Mrs. Roy Neal, Mrs. H. S. Sanders, Mrs. George Laing, Mrs. Jimmy Craft, Mrs. M. E. Kelley, Aurelia Sanders, and hostess, Mrs. Hite.

Attending the meeting were Mrs. John Laing, Mrs. Elsie Hawkins, Mrs. Wayne Rutherford, Mrs. Joe B. Temple, Mrs. L. K. Anderson, Mrs. R. W. McCaskill, Mrs. J. L. Hinson, Mrs. A. C. Barton, Mrs. Carra Morgan, Mrs. Gladys Gill, Mrs. S. C. Beavers, Mrs. Ethel Fry, Mrs. B. Campbell, Mrs. Mrs. Clyde Goodwin, Mrs. Marie Ross, Mrs. C. T. Richardson, Mrs. Lucille Price, Mrs. Roy Neal, Mrs. H. S. Sanders, Mrs. George Laing, Mrs. Jimmy Craft, Mrs. M. E. Kelley, Aurelia Sanders, and hostess, Mrs. Hite.

Mrs. Linda Laing Crowned Sorority Sweetheart

Mrs. Linda Laing was crowned Valentine Sweetheart of the Beta Sigma Phi Sorority, on Saturday, February 12, at the chapter's annual Valentine Banquet in the Earth Community Room.

The sweetheart was chosen by the members of the sorority in secret ballot. Mrs. Laing, the mother of one daughter, Lisa, age 2, was presented a beautiful rhinestone crown, a box of valentine candy, and a black oxys ring.

Mrs. Laing will send an 8x10 black and white glossy picture to International, where it will be entered in the 1967 Beta Sigma Phi Valentine Queen Contest. Each year this international contest is judged by a movie star. This year, Dick Van Dyke chose Rosemary Beachboard from Hickman Mills, Missouri as the queen.

The group enjoyed a buffet style dinner consisting of various casseroles, tossed vegetable salad, pies, hot rolls, tea, and coffee, served from a table with a white cloth, centered with an arrangement of red roses and a white satin heart.

Individual tables were set up, each being laid with a white linen cloth, centered with a lovely red candle.

The group enjoyed playing games of bingo, a commercial guessing game, and a spoon race. Among those receiving prizes were Mike Simmons, Don Randolph, Linda Laing, Robert Taylor, and Don Randolph.

Attending the banquet were Mr. and Mrs. Richard Bills, Mr. and Mrs. Mike Simmons, Mr. and Mrs. Rayburn Ott, Mr. and Mrs. Gary Cowley, Mr. and Mrs. Jim Williams, Mr. and Mrs. Don Randolph, Mr. and Mrs. Robert Taylor, and Mrs. Linda Laing.

Attending the banquet were Mr. and Mrs. Richard Bills, Mr. and Mrs. Mike Simmons, Mr. and Mrs. Rayburn Ott, Mr. and Mrs. Gary Cowley, Mr. and Mrs. Jim Williams, Mr. and Mrs. Don Randolph, Mr. and Mrs. Robert Taylor, and Mrs. Linda Laing.



MRS. LINDA LAING, new Beta Sigma Phi Sweetheart

Schellar Home Scene Of Associates Meeting

The LCC associates met Thursday in the lovely home of Mrs. Wayland Schellar.

Mrs. Ronald Cleavinger, Mrs. Carlis Bills, Mrs. Norman Ellis, Mrs. Lewis Faver, and Mrs. Lexie Branscum gave reports on the LCC Lectureship which was held in Lubbock last week. Each discussed a different lecture which she attended.

The hostess served cake, nuts, coffee, and Cokes to Mrs. John Garrett, Mrs. Fred Clayton, Mrs. Norman Clayton, Mrs. Ed Bell, Mrs. Norma Ellis, Mrs. Lexie Branscum, Mrs. Lewis Faver, Mrs. Ronald Cleavinger, and Mrs. Carlis Bills.

The next meeting will be on Thursday, March 3, in the home of Mrs. Claude Ellis.

Springlake GA's Have Mission Study

The Junior G. A. 's of the First Baptist Church, Springlake, met in the home of Mrs. Francis Watson Friday afternoon for a study of the mission book, "Guaym Boy."

Mrs. Myrtle Clayton taught the book which was on Panama. She was able to highlight the study by showing some of the Panama tour last summer and by showing pictures and souvenirs.

Following the study, hot dogs and the trimmings were served to Vickie McClure, Ronny James, Marilyn Eagle, Colita Biles, and sponsors Mrs. Billye Walden, Mrs. Francis Watson, and Mrs. Myrtle Clayton.

Francie Faver spent Friday night with Kim Stockstill.

Local GA's Attend Meeting

The associational G. A. meeting was held Saturday evening at 2:30 p. m. in the Springlake First Baptist Church.

The theme for the program was entitled "GA's Witnessing, Put Your Heart Into It."

Mrs. M. D. Durham, associational G. A. Director from Sunnyside called the meeting to order.

"Living For Jesus" and "Are Ye Able" were the songs led by Reba Hall.

Janice Barker, of Lums Chapel Baptist Church, and president of the associational GA's, presided over a short business meeting.

April 1 was the date set for the associational GA Junior banquet which will be held at the Littlefield First Baptist Church. On April 8, the other Junior GA group will have their banquet in the Dimmitt First Baptist Church. The Intermediate GA banquet is scheduled for April 15 in the Bovina Baptist Church.

Reba Hall and Ann Spencer brought the special music, entitled, "I'll Tell the World," Rev. J. Armstrong, pastor of the Calvary Baptist Church, Priona, brought the message. He talked on the many privileges American people enjoy, in comparison to those of the Europeans. He showed slides of the work he did while in Germany and a tour of several European countries.

The prayer command was read by Ann Spencer, Sunnyside, and assisted by Cindy Bell, also of Sunnyside. As Ann read the names of the missionaries who had birthdays, Cindy paced a pulpit on a poster which read, "GA's Witnessing, Put your Heart Into It."

The host church served refreshments of Cokes, hot chocolate and cookies.

Attending from the Earth First Baptist Church were Kim Welch, Cynthia Jaught, Regina Cole, Ruby Gonn, Lanita Lansford, Sharon Byers, Luanna Marshall, Terri and Toni Inglis, Barbara Buckner, Mrs. R. S. Cole, Mrs. Edwin O'Hair, and Mrs. Gerald Inglis.

Springlake Club Has Idea Exchange

The Springlake Home Demonstration Club met Thursday, February 10 in the home of Mrs. Oran Bibbey.

The meeting was called to order by president Pat Eagle.

The Club read the Home Demonstration Club prayer. Mrs. Edna McClure led the group in the singing of "America."

Everyone answered roll call with her maiden name.

Mrs. Ola Fanning was elected to attend the district home demonstration club meeting at Seminole. Mrs. Oma Pearl Murrell is alternate delegate.

Mrs. Pat Eagle, Mrs. Ola Fanning, and Mrs. Edna McClure were appointed to help in the Good Will Center Saturday.

Each lady brought something that she had made and demonstrated how it was made. Some brought food they had prepared and exchanged recipes.

Mrs. Wanda Martens receives the hostess gift.

Refreshments of coffee, soft drinks, dairy sandwiches, and marshmallow-date roll were served to eight members.

The next meeting will be February 24 in the home of Mrs. Floyd Bills. Mrs. Lady Claire Phillips, County Home Demonstration agent, will bring the program on new clothing techniques. Everyone is invited to attend.

Brownies To Discuss Chore Charts

Brownie troop no. 308 met Wednesday at the Scout Hut for their regular meeting.

Cathlene Anderson led the group in the Brownie Promise, the pledge to the flag, and the Brownie Smile Song.

Mrs. Phillip Haberter directed the girls in making valentine place cards which were used at the father-daughter sweetheart box supper Monday night.

At the next meeting, the girls will discuss their chore charts which they have been working on for several weeks.

Cathlene Anderson served Cokes and Cookies to the 16 girls attending.

Norman Ellis and Lewis Faver were in Lubbock Friday on business and visited in the home of Mr. and Mrs. Bob Dummigan.

Mr. and Mrs. Watson and Schellar visited over the weekend with their parents, Mr. and Mrs. Eppers, Abilene.

Cadets Meet In Home Of Mrs. Hodge

The Cadets met Friday at 4 p. m. in the home of their leader, Mrs. Bi Ly Hodge.

The group completed their work on the decorations they were making for the father-daughter box supper which was held Monday night.

Mrs. Hodge served punch and cookies to Venissa Simmons, Welda Barton, Annette Hodge, and Susie Adrian.

The next meeting will be Friday at 4 p. m. in Mrs. Hodge's home. All interested 7th and 8th grade girls are invited to attend.

DEN 2 MAKES INDIAN MACCASN

Den 2 of the Cub Scouts met Tuesday afternoon at 4 p. m. with den mothers Mrs. Hershel Wilson and Mrs. Ann Jones.

The opening ceremony was led by Donald Monpelonga.

The boys welcomed Ronnie Coon as the new member.

They worked on their Indian moccasins, followed by refreshments of Cokes and cookies which were served by Mrs. Wilson.

Den chief, Mike West led the living circle.

DEN 6 PREPARES BANQUET FAVORS

Den 1 of the Cub Scouts met Friday afternoon at 4 p. m. in the Scout House with their den mother, Mrs. Janie Bell.

Kenneth Wimberly led the opening ceremony.

The boys worked on favors for the banquet and their skit. Refreshments were enjoyed by all.

The living circle for the closing was led by den chief, Danny O'Hair.

Weekend visitors in the home of Mr. and Mrs. Phil Raught were Mr. and Mrs. J. J. Webb, Mr. and Mrs. Verne Sowley, and Mrs. Lela Henson, Littlefield.

Congratulations...

TO A WONDERFUL
JUNIOR HIGH BASKETBALL TEAM
FOR WINNING THE SPRINGLAKE-EARTH TOURNAMENT

NOW LET'S
TAKE DISTRICT
WE ARE BACKING YOU ALL THE WAY

WHITE'S

DOUG AVERY Owner Manager EARTH, TEXAS

THANK YOU

FOR MAKING OUR GRAND OPENING
A SUCCESS

Our Prize Winners
ARE

1st-LINDA COWLEY
2nd-ALICIA GALLOWAY
3rd-HELEN PHILLIPS

WE HIGHLY RECOMMEND
PRINCESS NYLA
COSMETICS
BY NYLA LABORATORIES

THIS FORMULA HAS BEEN
APPROVED BY DERMATOLOGISTS
ON SKIN BEAUTY.....

MONDAY IS RESERVED FOR MEN ONLY
SCALP TREATMENT (HAIR RESTORER) CONDITIONING

EARTH BEAUTY SALON

CALL JACK or SHARRON--257-5781--EARLY or LATE

**YOU
SAVE
ENOUGH
TO BUY**

**WHEN
YOU DRY
WITH
GAS**

TWO MONTHS SUPPLY OF MILK

SAVE ON INSTALLATION AND MAINTENANCE, TOO. A GAS clothes dryer costs less to install and maintenance costs are the lowest of any dryer. A GAS burner, the heart of your dryer, carries a lifetime guarantee.

When you dry your clothes with GAS, you can save \$29.76 a year on your utility bill! That's enough to buy twenty-five gallons of milk... a two months supply for an average family of four. You get quality performance, too. GAS dries your clothes faster, yet gently... and leaves them as fresh as springtime.

Pioneer Natural Gas Company

WOLVERETTES TAKE DISTRICT 3-A CHAMPIONSHIP

The Springlake-Earth Wolverettes finished up a perfect 10-0 record in district 3A competition Friday night, downing a stubborn Kress squad 62-38.

The Wolverettes got off to a slow start and found themselves trailing at the end of the first quarter 4-9, but went into the dressing room at the end of halftime with a one point lead of 27-26.

At the beginning of the third quarter they began to look alive and really started rolling. At the end of the third quarter the Wolverettes had a 42-33 lead and during the fourth quarter they really gave Kress the works, with Susan Britton doing some great jump shooting from the outside.

Susan Britton took high point honor for the Wolverettes with 29 points followed by Anita O'Hair with 20, Alicia Washington with 7, Marsha Dawson and Dalpha Banks rounded out the scoring with 3 points each.

High point girls for Kress was Harris with 14, followed by Scott with 11, Laurie with 9 and Bartke with 4 points.

Glasscock Receives Broken Bone

Barney Glasscock received a broken bone in his left leg recently as he was rounding up cattle on the Halsell Ranch.

He was taken to the Green Memorial Hospital, Muleshoe, where he received a full cast on his leg.

He is reported to be much improved.



JUNIOR HIGH GIRLS TAKE FIRST PLACE in the Junior High Basketball Tourney last weekend in the Springlake-Earth gymnasium. Members of the superior team are proudly displaying their trophy.

Junior High Girls Win First, Boys Third

Whoopie, what an exciting basketball tournament the Junior High Tourney at the Spring-

lake-Earth Gymnasium last week-end turned out to be, Friday and Saturday local fans

saw some real great games played by Junior High students of the area.

The Springlake-Earth girls took first place by defeating the Lazbuddie girls 31-27 in a thrilling finish. The local girls led all the way, by, but by only a slim margin. At the end of the first quarter the score was 12-5.

At halftime it was 18-15, and 28-17 at the end of the third quarter. The local team had to battle for their lives to hold the rampaging Lazbuddie squad until the final whistle blew to win 31-27.

Debbie Matlock took high point honor with 17 points, followed by Vickie Gregory with 11 and Jan Hedges with 3.

For Lazbuddie the high point honor went to Mickey Broyles with 11 points, Vicki Robinson with 7, Theresa Seaton 7, and Raygna Trieder with 2 points.

The Springlake-Earth Junior High boys played one of their best games of the year, defeating the Hart boys 40-38. The local boys got off to a slow

start but once they began moving, they never gave up the lead over Hart. By quarters the local quintet led 8-7, 19-14, 34-24, and finished with a 40-38 victory to take third place in the tournament.

The Amherst boys defeated Tulsa to take first place in the boys division, and third place honors went to Muleshoe in the girls division.

This weekend the district Junior High Tournament will be held in Hart and all local fans are encouraged to turn out and back the local players.

PARTY LINE

Judy Zawn, granddaughter of Mrs. D. M. Allen, left Monday to return to her home in Pine City, Minnesota. She has been visiting Mrs. Allen and other relatives in Earth since October.

Kangaroos Defeat Wolverines 56-39 To Close-Out Season

The last basketball game played for Springlake-Earth was played Friday night by three senior members of the Wolverine squad, Jerry Don Sanders, Ken Dawson, and Pete Glasscock. Although they were defeated in this their last game the entire squad gave it a good try.

The Kress squad downed the Wolverines 56-39, after trailing at the end of the first half 22-17.

The Wolverines took the lead in the first quarter 11-4 and played good ball until the Kangaroos started taking advantage of quick breaks, and with good outside shooting from Fields,

and Burk they nailed down the victory.

The Wolverines trailed at the end of the third quarter 41-28 and found themselves on the short end of a 56-39 score at the end of the game.

High point man for the Wolverines was Sanders with 15, followed by Messer with 7, Armstrong and Dawson with 6, Glasscock and Washington with 2, and by Parish with 1. Cole and Stockard did not score.

For Kress the high point honor went to Burk with 20, followed by Fields with 17, Watson 8, Lockridge 7, and Bohner, with 4.

PARTY LINE

Saturday evening dinner guests in the home of Mr. and Mrs. Bill Chaney were Mr. and Mrs. S. H. Chaney and Gene and Janis Holt.

Mr. and Mrs. O. L. Anderson

returned Saturday from a four day's visit with relatives in San Angelo, Big Springs, Sterling, and Mertzon.

Mrs. Roney Smith and Terri Carol attended a birthday dinner for Mrs. Smith's father in the home of her parents, Mr.

Wolverine "B" Team Defeat Kress 42-39

The Springlake-Earth "B" Team all the way Friday night taking a slim 42-39 victory.

The "B" team led all the way, having a 11-6 margin at the end of the first quarter, 21-18 at halftime, 32-25 at the third quarter, and stood firm against a charging Kress squad to bring home the victory 42-39.

Tim Mathews, led the Wolverines in the scoring column with 15 points, followed by Perry O'Hair, Ruckey West, and Gary Kelley each with 8 points. D. C. Thomas had 3, the other two members of the "B" team Randy Clayton and Jimmy Stockstill did not score.

and Mrs. Jimmie Ivy, Lazbuddie, on February 10. Also present were Mr. and Mrs. Ronnie Ivy, Chase Paul, Lazbuddie and Mr. and Mrs. Jimmie D. Ivy, Hereford.



THIRD PLACE WINNERS in the Junior High Basketball tournament last weekend were the Muleshoe girls and the Springlake-Earth boys.



AMHERST BOYS WIN Springlake-Earth touney last weekend and carried home the beautiful First Place Trophy. Pictured with the trophy are members of the spunky little team.

DON'T LET THIS HAPPEN

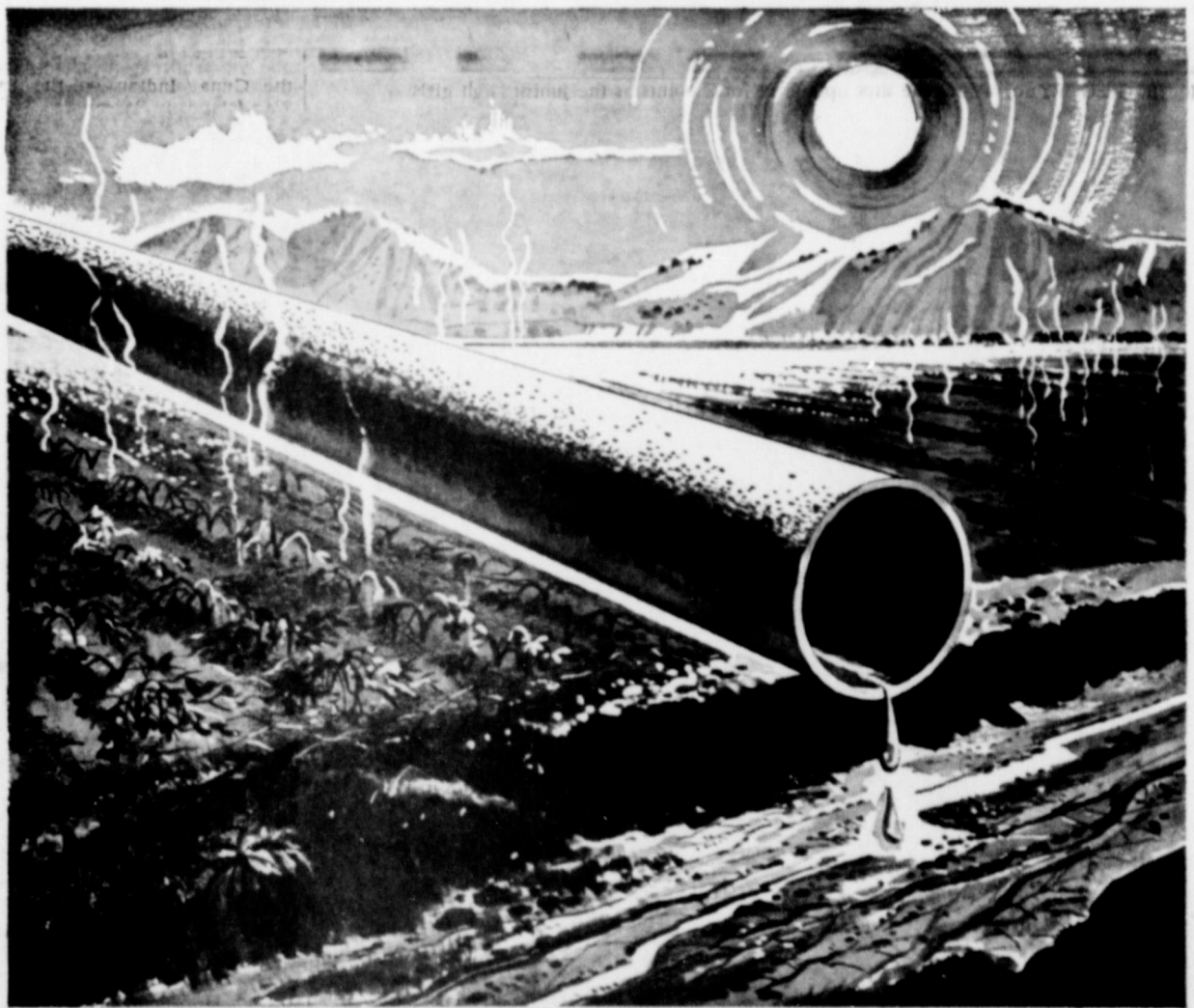

BUT IT CAN HAPPEN TO YOU...

TAKE ALL PROTECTIVE MEASURES NOW BEFORE THE SEASON GETS INTO FULL SWING.....

WE SPECIALIZE IN PUMP SERVICE, BALING and CLEAN-OUT WORK and GEARHEAD REPAIRS...

CUSTOM WELDING and MACHINE WORK

WE SERVICE ALL MODELS OF DOMESTIC WELLS AND SEBMEERSIBLE PUMPS.....



OD's Pump & Machine Shop

EARTH, TEXAS

PHONE 257-2951

SULFUR - CALCIUM MAGNESIUM - IRON

all in SMITH-DOUGLASS SACCO ammonium phosphate fertilizer



All crops need trace elements. Smith-Douglass manufactures PELLEFORM with TREL. PELLEFORM contains all of the trace elements contained in SACCO plus TREL. TREL is an exclusive formula of trace elements found only in Smith-Douglass PELLEFORM. TREL is a combination of all trace elements known to be needed by crops.

Whether you use SACCO or PELLEFORM, you can depend on the integrity and quality of Smith-Douglass.

ORDER NOW FROM PAUL LANDERS AT

EARTH FARM SUPPLY

THE COFFEE IS ALWAYS HOT

Phone 257-5941

PAUL LANDERS Owner Manager

Eastern Star Observes Friendship Night

The Earth Chapter of Eastern Star held its friendship night on Monday, February 14 in the Masonic Lodge Hall at 6 p. m. The hall and dining room were beautifully decorated in the Valentine motif. Delicious salads, pies, and ham were served to approximately 100 people from the Earth chapter and visiting chapters from Sudan, Littlefield, Hale Center, Muleshoe, Olton, Dimmitt, Plainview, and Hereford. Following the meal, the Springlake-Earth High School stage band entertained the group, under the direction of

Dean Foshee, band director. The stated meeting was held at 7:30. Following this meeting past matrons and past patrons of the Earth chapter and visiting chapters. Twenty one past patrons and matrons of the Earth chapter were present, with a large group of past matrons and patrons from other chapters. This group was honored with a musical program, of songs which were popular in 1940 to the present date. Mrs. George Laing accompanied the group at the piano and played interludes throughout the program. They were presented with corsages, candy,

and small gavels. One of the highlights of the evening was the viewing of the past matrons of Earth who wore the same dresses that they wore when they were installed or that they wore to Grand Chapter. The Worthy Patron, Donald Kelley, was honored by his three daughters with a trio number and a box of valentine candy. Past matrons and past patron of the local chapter that were honored are as follows: Mr. and Mrs. M. E. Kelley, Mrs. John Laing, Mrs. Myrtle Clayton, Mr. and Mrs. J. A. Littleton, Mrs. O. B. Whitford,



VICKIE GREGORY no. 41 get the shot up and in for 2 points as the Junior High girls won the game 31-27. No. 55 is Jan Hodges, a forward for Springlake-Earth.

Mrs. George Laing To Show Panama Slides To G.A.'s

The Junior and Intermediate G.A.'s met at the Earth First Baptist Church on Tuesday at 4 p. m. for their mission study on "Guaymi Boy." The meeting opened with the song "The Land Between." Mrs. Zou Wilson, Mr. and Mrs. C. P. Parish, Mrs. Gene Brown, Mrs. J. A. Littleton, Jr., Mr. and Mrs. A. E. O'Hair, Mr. and Mrs. Jerry Kelley, Mr. and Mrs. Bob Armstrong, Mr. and Mrs. K. B. Parish, and Mr. and Mrs. Donald Runyon.

WMU To View Film On Panama

The WMU of the Earth First Baptist Church met Tuesday at 7:30 p. m. for their mission study entitled, "The Land Between." Mrs. Frank Wuerlein read the prayer calendar, followed by Mrs. Pete O'Hair leading the prayer for all the missionaries who have birthdays this week. The devotional, taken from Psalms 104-24-31 and Matthew 43:48, was given by Mrs. Gerald Inglis. Mission study chairman, Mrs. Frank Wuerlein, was in charge of the mission program. The location, temperature, leading cities, rainfall, and climate of Panama were reviewed, followed by a brief study of its history since 1501 to the present time.

The way in which the people in Panama carry on business, their various industries, and the crops were thoroughly discussed in an interesting manner by the mission study chairman. Four main Indian tribes in Panama were studied. They were the West Indian, the Guaymi, the Chaco, and the Cuna. Their food, customs, dress, and various habits were interestingly discussed and compared. It was learned that there are 106 missionaries in Panama. A large number of these missionaries are natives who have been converted. It is a trait of the people of Panama to tell others of Christ once they learn the story themselves.

Prior to the closing of the meeting, the group toured the G.A. mission study room, and became better acquainted with the work of the Guaymi Indians. Mrs. R. S. Cole led the closing prayer. The next meeting will be on Tuesday, February 22 at 7:30 p. m., at which time Mrs. George Laing will show a film on her work as missionary to the Cuna Indian on the San Blas Islands in Panama.

group playing spin the bottle. Each girl was asked to read and answer a question concerning the mission study when the bottle was spun and pointed to her. Mrs. R. S. Cole presented the devotional based on John 3:16 and Mark 11:22. She gave several every-day illustrations of faith.

A group of words, persons, places, or things, was placed before the group. Each girl told how the words pertained to the story of "Guaymi Boy." Mrs. Edwin O'Hair told the story of yesterday's hero, Dr. William C. Gorgas. Dr. Gorgas was sent by Theodore Roosevelt to Panama to help solve the problem of yellow fever there. The Gorgas Hospital in Panama received its name from Dr. Gorgas.

Today's hero, Henry Fandoval, was discussed by Jill McCord. Mr. Fandoval was from New Mexico, who went to Panama with the purpose of sharing the message of Christ. Each girl chose a treasure from the treasure chest, which was a fact concerning the country, climate, custom, or nature of Panama. Refreshments of Valentine cake and hot apple cider were served by Mrs. Edwin O'Hair and Jill McCord to Sharon Clark, Lajuana Marshall, Dubra Merck, Leah Galloway, Ruby Coon, Regina Cole, Lanita Lunsford, Cynthia Raught, Kim Welch, Barbara Buckner, Terri Inglis, Vicki Head, and Earlene and Mary Nell Walker. At next week's meeting, Mrs. George Laing will show slides of her work as a missionary to the Cuna Indians on San Blas Islands in Panama.

Mrs. A. M. Sanders entered the Amherst Hospital on Tuesday, February 1. She is reported to be in serious condition.

NOTICE

Members and friends of the WSCS of the Plainview District should be making plans for their District retreat which will be at Geta Canyon, on March 3 and 4. Pre-registration should be made in February.

A come and go going-away tea honoring Miss Mary (Skeet) Anderson will be held at the Girl Scout House in Littlefield on February 20 from 3 to 5 p. m. Registered adults and ladies who have worked with girl scouts previously, and cadets and girls of senior level are invited to attend.

Young Homemakers Taking Knitting Course

The Springlake-Earth chapter of Young Homemakers met on Monday, February 14 in the Home Economics room at Springlake-Earth School. Mrs. Basil Sherman and Mrs. Lynn Fite, Olton, began a short course in knitting. A short business meeting was conducted with Mrs. Neil Pounds, president in charge. Refreshments of delicious cookies, punch, and coffee were served by Mrs. Norman Clayton and Mrs. Ed Bell to the following: Mrs. Johnny Pellham, Mrs. Gayland Stephens, Mrs. Truman Layman, Mrs. Dean Jones, Mrs. Neil Pounds, Mrs. Jearl James, Mrs. Larry

Religious Drama Presented At Springlake Church

"Challenge of The Cross" was the theme of a religious drama presented by the Intermediates of the Hart Baptist Church Sunday evening during the worship service in the Springlake Baptist Church.

David McGinnish, music director of the Hart Baptist Church, rendered the special music en-

gaged. The main question the group was trying to present was, "What do we do with the cross of our lives? Is it too heavy for us to bear?" The group answered the question in a very unique and inspiring manner. Following the drama, a fellowship was given in the fellowship hall. Refreshments were served to all those attending.

NOTICE

The 4-H Club will meet on February 21 at 7:30 p. m. in the Springlake-Earth Junior High building. All members who will have a showing in the fat stock show the following weekend are urged to attend.

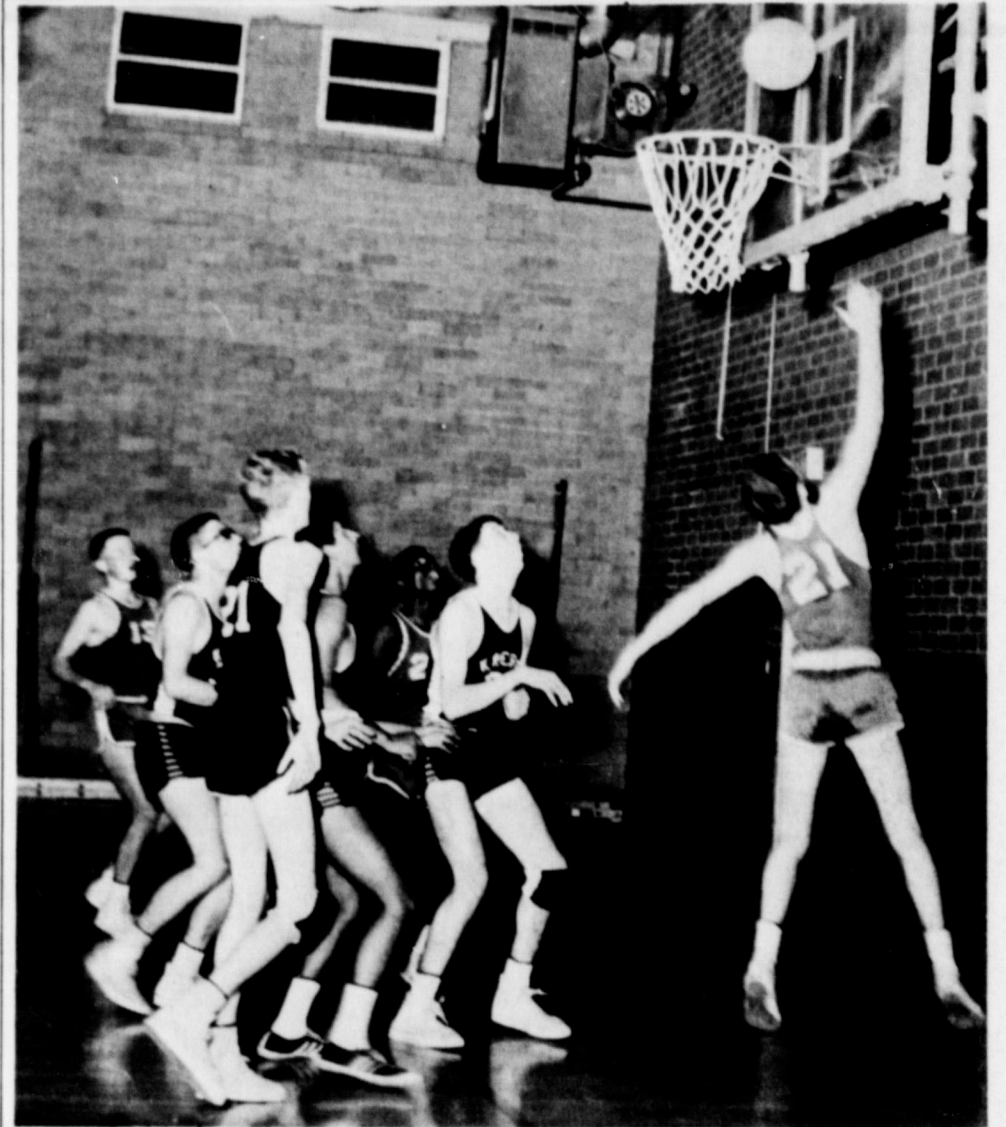

RICKY WEST no. 21 lays it up and in for 2 points as the Wolverines "B" team defeated Kress Friday night 42-39 in a hard fought game.

Powerful...economical



THE MASSEY-FERGUSON 1100 and THE SHIFT ON THE GO---ALLIS-CHALMERS XT ONE NINETY...

WE ARE Proud To Announce THAT WE HAVE Two Field Representatives To Serve You THEY ARE ELMO PRUITT -Muleshoe E. L. BUCK -Hart CHECK WITH THESE MEN IF YOU NEED FARM EQUIPMENT

WE ARE YOUR MASSEY-FERGUSON...ALLIS-CHALMERS DEALER

B & P IMPLEMENT CO.

DIMMITT, TEXAS PHONE 617-5475

Wake Up Sleepyhead...



it's the mattress sale of the year

SEALY '66...your year to sleep better, save bigger

SEALY ANNIVERSARY SALE SPECIAL VALUES

REDUCED!
Below Sealy's former nationally advertised price



Firm Golden Classic

- Smooth, button-free surface
- Edge Gards® end sagging edges
- Duro-Flange keeps surface smooth
- Heavy, decorator print cover

NOW ONLY **\$39⁸⁸**

Full or twin size each piece

UNBEATABLE!

Our lowest price for a luxurious extra firm and quilted Sealy mattress

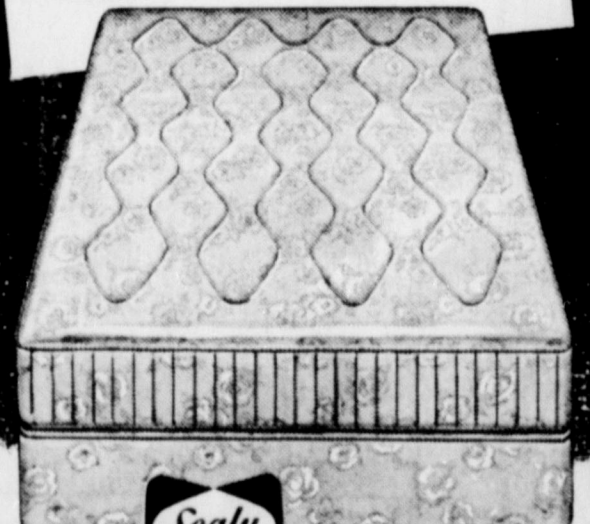

Sealy Quilt Supreme

- Puffy, deep-quilted surface
- Rich gold-brocaded damask cover
- Duro-Flange keeps surface smooth
- Edge Gards® end sagging edges

NOW ONLY **\$49⁹⁵**

Full or twin size each piece

JOHNSON-POOL FURNITURE

MULESHOE, TEXAS

Put **WANT ADS** to work for you

WANT ADS

to work for you

POLITICAL ANNOUNCEMENTS
The News has been authorized to announce the candidacy of the following persons, for the offices indicated, subject to the action of the Democratic Primaries:
State Senator-30th Senatorial District
Jack Hightower
For County Comm., Precinct 2
Henry Lewis
County Clerk-Lamb County
Charles D. Jones
District Clerk
Ernest L. Owens (Re-election)
Ray Lynn Britt
County School Superintendent
C. Roy Stevens

SPRINGLAKE NEWS
by Sue Ann Bunner
Mr. and Mrs. David Grimsley of Friona visited his mother, Mrs. Esther Bomar, Sunday. Mr. and Mrs. B. L. Skinner returned home Thursday from an extended vacation in California. They left Friday for Dumas to visit with their son's family. Mr. and Mrs. Loyd Skinner and children, Mrs. Myrtle Clayton visited Mrs. Floy Choate Friday afternoon. Mr. and Mrs. Ed Orr and Kathy were in Vernon last week to visit relatives. They left after Wednesday evening services and returned Saturday. The Young People's class of the Church of Christ will be in Hart next Sunday for a singing. Mrs. Dorothy Washington and

her new son, Steven Lee, were honored Wednesday afternoon with a coffee in their home. Mrs. Washington opened the gifts for her son. Refreshments were served to Mrs. Bobbie Banks, Mrs. Sue Ann Bunner, Mrs. Delma Clayton, Mrs. Mary Clayton, Mrs. Marshall Hinson, Mrs. Eva Hopping, Mrs. Carmelita Barnett, Mrs. Evelyn Bridges, Mrs. Jean Byers, Mrs. Elizabeth Packard, Mrs. Doris Winder, Mrs. Pat Washington, Mrs. Donna Townsend, Mrs. Pauline Hucks, and several children. Mrs. Francis Watson and Monte visited in the P. A. Washington home Sunday afternoon. Mr. and Mrs. Ed White and James from Sundown and Mr. and Mrs. R. M. Crawford and Charlotte of Amherst visited their parents, Mr. and Mrs. W. C. White Saturday evening. Mrs. Inez Ott of Plainview and Mrs. Iva James of Lubbock visited Mr. and Mrs. W. C. White Sunday. Mrs. Ott and Mrs. James are Mrs. White's sisters. The group visited with Mrs.

Geneva Ott in the Sunnyside Community Sunday afternoon. Mr. and Mrs. Harry Ellyson of Sundown and Mrs. Margaret McCollum, Arlene and Anita, of Lamesa visited in the Robert Bunner home Sunday afternoon. Mr. and Mrs. W. C. White, Mr. and Mrs. B. V. Padon, and Mr. and Mrs. Jesse Padon of Amherst left Tuesday for a fishing trip at Falcon Lake. Bruce Bridges showed his sheep Wednesday in El Paso and placed fourth in the Southdown Division. The animal was sold on Friday. Mrs. Evelyn Bridges, Miss Eva Ray Hawkins, and Miss Carolyn Reynolds went to Lubbock Tuesday. They saw the movie "Sound of Music." Mr. and Mrs. Kenneth Heard and Emmett of Littlefield visited their parents, the Herbert Millers, Sunday afternoon. A religious drama, "The Challenge of the Cross," was presented Sunday night in the First Baptist Church. The intermediates from the First Baptist Church of Hart came to Springlake to present the drama. Mr. and Mrs. Gordon Walden of Littlefield visited the Lowell Waldens Sunday. Mr. and Mrs. Delvin Walden

have moved to the Ardis Barton house two miles north of the school. Rev. and Mrs. W. F. Smith of Clairmont visited the Lowell Waldens on Thursday afternoon. Don Watson is reported to be recuperating satisfactorily from surgery in Littlefield Monday.
PARTY LINE
Mr. and Mrs. Glenn Boozer, Lubbock, were guests Sunday evening in the home of Mr. and Mrs. Bill Beasley.
Mrs. S. C. Beavers attended the funeral of Mrs. Essie Edwards in Clovis on Friday morning.

Mrs. Don Huley returned to Dallas last week, following a week's visit in Earth with relatives and friends.
Mrs. Cornelia True'ock returned Sunday from a visit in Sulphur Springs with her daughter and family. Mr. and Mrs. Harvey Smith, Sunday evening dinner guests in the home of Mrs. M. E. Clayton were Mr. and Mrs. V. E. Simmons, Riverside California. Claude Ellis was a Sunday dinner guest in the Lewis Faver home.

AS NEAR AS YOUR TELEPHONE

Oxygen Equipped Air Conditioned
PARSONS FUNERAL HOME
Phone 285-2621 Collect
We Accept Any Funeral Home Burial Policy

Excerpts From Congressional Record
5. Major unions of Federal employees have endorsed legislation to widen the use of chiropractic in Federal compensation work.
Bennett Chiropractic Clinic
LITTLEFIELD, TEXAS

WE Rewind Motors Repair Washers & Dryers and all other Appliances
WE CAN DO ALL YOUR PLUMBING WORK
TRUELOCK PLUMBING & ELECTRIC
DAY 257-5861 NIGHT 257-4881

BOZEMAN AUCTION SERVICE
121 26th Street, Littlefield, Texas
PHONE 257-3982 NIGHT PHONE 257-3982

FOR SALE: Squire Webster tape recorder, 4 track stereo. See Wilson Lewis, Phone 257-5201. 2/3/tic.
FOR SALE: 2 year old brick home, 3 bedroom, 2 baths, large paneled den with fireplace. Built-in dishwasher, double oven. Fully carpeted, about 2050 sq. feet plus large double garage. Also has refrigerated air and inter com throughout. \$20,500. Excellent terms. Call collect Jim Mills, Realtor, 385-5989, Littlefield, 2/3/4tp.

FOR SALE OR RENT
NUMBER I
Luxury home with 3250 sq. ft. of living space.
NUMBER II
2500 Sq. ft., business property, suited for office. 2 family residence, etc. Presently furnished as medical clinic. Call C. H. Bausman, M.D. at Post, Texas. Keys will be with L. D. Henderson or Neil Pounds.
FOR SALE: 4 bedroom house, 2 baths, Terms of trade. Carlis Bills 257-5561. 2/3/tic.

FOR SALE: 30' Catalina Electric Range, Thursday and Friday only. Phone Dub Merck 257-2981. 2/17/tic.
NEEDED: Sales representative, part or full time, unlimited earnings. Write Sam W. Williams, Box 666, Abemathy, Texas. 2/17/4tp.
FOR RENT: Small furnished house. Call Cecil Parish, 257-5261. 2/17/tic.
FOR SALE OR TRADE: 3 bedroom house in Earth, bath and 3/4 bath, attached garage. 603 2nd. Place in Earth. Phone 227-3891, Sudar 11/4/tic.
To party with good credit, repossessed Singer sewing machine in walnut cabinet. Automatic zig-zagger, makes fancy stitches, button holes, blind hems, etc. 5 payments at \$5.26 or \$25.00 cash. Write Credit Manager, 1114 19th Street, Lubbock, Texas. 2/17/tic.
FOR SALE: '58 Chevy Impala, 2 door, hard top. Call Johnny West, 986-2482. 2/10/4tp.
FOR SALE: 1963 Bel Aire 4 door Chevrolet, radio, heater, air conditioner, automatic transmission. Contact Ed Bell, 257-3072. 2/10/tic.

GET La-Z-Boy AT Taylor Furniture

MONUMENTS
Winnboro Blue Granite
White Georgia Marble
and Others
Including Bronze for Memorial Park Specifications
See Percy or Connor Parsons
or Call Collect
Olton, Texas
Phone 285-2451 or 385-2797

TAYLOR FURNITURE
G. E. Appliances
Check Our Prices Before You Buy
We Finance

QUICKBALL PRYOR CO., INC.
Automobile Parts
Supplies & Equip.
P.O. Box 567
Earth, Texas

O. D.'s Pump and Machine
NOW IS THE TIME TO GET IRRIGATION PUMPS IN TIP-TOP SHAPE FOR THE COMING SEASON

ACETYLENE AND ELECTRIC WELDING GENERAL SHOP WORK
NEW PUMP SALES
O. D.'s Pump and Machine
PHONE 257-2951 EARTH

HAMMONS FUNERAL HOME
Ambulance Service
Phone 385-5121
LITTLEFIELD, TEX.

Francis Implement Co.
Your Ford Tractor Dealer
Muleshoe, Texas
Pd. Adv.

FEEDERS GRAIN, INC.
DAILY BUYERS FOR CATTLE FEEDERS
Federal Storage License 3-4451
We Can Use Your Grain
SUDAN LIVESTOCK and FEEDING CO.
Phone 227-5321 Sudan

EXCHANGE TRUCK SEATS
SEAT COVERS & CARPET FOR ALL CARS
McCormick Auto Supply and Trim Shop
Phone 385-4555 LITTLEFIELD 227 MAIN

PAYNE FUNERAL HOME
PHONE 246-3351- AMHERST, TEXAS

Welcome to Earth

MR. CHARLES R. HOLT
Welcome to Earth to Charles R. Holt, new science teacher at Springlake-Earth High School...
MR. HOLT WAS SECURED AT MID-TERM... HE HAS A MASTERS DEGREE IN BIOLOGY...
The Holt Family plan to move to Earth as soon as suitable housing can be obtained. Mr. and Mrs. Holt have two children, Brenda 5 and Charles 3. They are affiliated with the Church of Christ. Mr. Holt received his B.S. degree from W.T.S.C. and his Master's degree in Biology at East Texas State. He has had 5 years teaching experience, two at Grants, New, Mexico and three in the Hereford Schools.

TURNKEY IRRIGATION SYSTEMS
Johnston & Nebraska Western Pumps; Irrigation Well Drilling & Casing; Redi Rain Sprinkler Systems; Wagner Sprinkler Pipe Movers; Mesa Tow Pans for Sprinkler Pipe; Asbestos Cement Plastics & Steel Pipe; Continental & Chrysler Engines; Engine Overhaul & Repairs; Pumps Pulled, Set and Repaired.
Check our prices before you buy... WE CAN SAVE YOU MONEY
SNEED SUPPLY, Muleshoe, Texas
410 N. First St. Phone 272-3426

YOU CAN SELECT YOUR OWN CHOICE BEEF AT EARTH ELEVATOR FEED LOT
Phone 257-4031 EARTH, TEXAS

THE FOLLOWING MERCHANTS EXTEND THEIR WELCOME TO ALL NEWCOMERS

PATTERSON BROS. GROCERY EARTH, TEXAS	PIGGLY WIGGLY EARTH, TEXAS
SUNSET DRIVE-IN THEATRE EARTH, TEXAS	EARTH OIL & GAS CO., INC. M. H. BEEN, Manager
EARTH CLEANERS EARTH, TEXAS	GIFT & FABRIC SHOP EARTH, TEXAS
EARTH FARM SUPPLY PHONE 257-5941 EARTH, TEXAS	CITIZENS STATE BANK MEMBER F. D. I. C. EARTH, TEXAS
The EARTH NEWS-SUN EARTH, TEXAS	E. S. S. CO., INC. EARTH, TEXAS

Hamilton Promoted To Cadet Sergeant At NMMI

Lynn Hamilton, son of Mr. and Mrs. B. T. Hamilton, was promoted from Corporal to Sergeant at the New Mexico Military Institute in Roswell, New Mexico, last week.

Lynn has attended NMMI for two years, and will graduate in May of this year.

He has been very active while at NMMI. He received his let-

ter in football, has been a member of the band, which is an extra activity for which no credit is given, sang in the Chapel Choir, has been a member of the dance band, made up of Cadets who played for numerous dances in and around Roswell, and received the "Best New Cadet Award," at the end of his Junior year.

W. N. Larkin Dies in Midland

W. N. Larkin, 59, a long time resident of Pampa, died suddenly on Thursday, February 10, Mr. Larkin was employed by Neimro Motor Corporation, and was in Midland working on his job at the time of death.

Funeral services were held Saturday, February 12, at 2 p. m., in the Carmichael-Wheatley Funeral Chapel in Pampa with Rev. Joe Hawn, pastor, of the Central Baptist Church officiating, assisted by Rev. Thurman Upshaw, pastor of the Central Baptist Church of Pampa.

Survivors include his wife, Nell; one daughter, Mrs. Gene Hays, Mesquite; four sons, Don, Springlake, Larry, Shreveport, Louisiana, and Lloyd and Ronnie of the home; his mother, Mrs. P. C. Larkin, Rising Star; six sisters, one brother, and ten grandchildren.

Interment was in the Memory Gardens Cemetery in Pampa.

Father of Local Resident Dies

W. T. Tosh, 72, of De Queen, Arkansas, died on Thursday, February 10, in the General Hospital in De Queen. He had been ill about six weeks.

Funeral services were held in the Wilkerson Funeral Chapel in De Queen on Saturday, February 12. Interment was in Redman Cemetery at De Queen.

Mr. Tosh is survived by his wife; three daughters, Mrs. Francis Kelley, Earth Mrs. G. V. Jeremiah, Percy, Illinois, and Mrs. Della Detmer, De Queen; two sons, Delbert, Cocoa, Florida, and Raymond, De Queen; one half sister, Bertha Johnson, Winnie, Arkansas; 15 grandchildren; and 4 great grandchildren.

Friday dinner guests in the home of Mr. and Mrs. Leroy Wilkerson were Mrs. Lela Hanes, Mabine, and Mrs. Raymond Morgan, Clovis.



TULIA AND LAZBUDDIE TAKE SECOND PLACE trophies Saturday night at the final games played in the local Junior High Tourney. Pictured with their hard earned trophies are the Tulia boys and the Lazbuddie girls.

Four From Area Enrol at LCC

Four Earth students have enrolled for the spring semester at Lubbock Christian College as a part of the 730 member student body this term.

Mikey Dent, son of Mr. and Mrs. T. L. Dent, of Lubbock, is the lone freshman in the group. He is an agriculture-business major.

Janet Cooper, daughter of Mr. H. M. Cooper of Springlake, Judy Perkins, daughter of Mr. and Mrs. Carl Perkins also of Springlake and Mrs. Agnes Dent, daughter of Mr. and Mrs. F. F. Bozeman are all sophomore students.

LCC's large student body this spring has set an all-time high for spring enrollment. There are 28 foreign students and 21 states represented.

The young college was founded in 1957. It is fully accredited, offering associate degrees in 12 fields.

PARTY LINE

Mrs. Marcus Messer and Mrs. W. C. Lee visited in the L. T. Smith home Monday afternoon.

Mrs. Billie Davis, Dimmitt, was a guest Saturday in the home of Mr. and Mrs. L. T. Smith.

Weekend visitors in the Billie Robnett home were Mr. and Mrs. L. V. Etheridge, Paula, and Suzie, Lovington, N. M.

Mrs. W. V. Jones, Jr., and Mrs. Clarence Hamilton were in Plainview Monday.

Tunnell Receives Broken Knee

Gene Tunnell received a broken knee last week while working on the Halsell Ranch in Nowata, Oklahoma.

Tunnell was working the cattle when his horse tripped caus-

ing him to fall from it, and the horse falling on his knee. Tunnell was immediately taken to the hospital in Nowata, where a partial cast was put on his knee.

He returned home on February 8, and was taken to the Muleshoe Hospital where he was given a full cast.

He is reported to be doing fine.

PARTY LINE

Mr. and Mrs. Lynn Glasscock and Mr. and Mrs. Douglas Parish spent Saturday and Sunday in Ruidosa.

Mr. and Mrs. Jim Williams, Patsy and Cindy attended the wedding of Darrell Williams and Diane Gloyna in Plainview Friday evening.



A GOOD EXAMPLE of the defense the Junior High girls put up in defeating Lazbuddie for the championship of the Springlake-Earth tournament Saturday night. The Junior High girls won the game 31-27.

SPECIAL!
HAVE YOUR EQUIPMENT REPAIRED NOW

SPECIAL MID-WINTER PRICES ON LABOR and PARTS

ON REPAIR JOBS FOR \$50.00 OR MORE - FRY & COX WILL PICK-UP EQUIPMENT, REPAIR AND RETURN TO YOU...

NO TRUCKING CHARGES (Balance of February Only)

SEE LEE ROY HUGHES FOR DETAILS

FRY & COX

401 So. 1st-Phone 272-4511 Muleshoe

FOR CONVENIENCE AND RELIABLE SERVICE, HAVE YOUR DOCTOR CALL YOUR PRESCRIPTIONS TO POUNDS PHARMACY, IT WILL BE READY WHEN YOU GET HERE. 2/3/4tc.

FREE!
Your Child's Portrait in **LIVING COLOR**

Any age, any number of children accompanied by a parent will be photographed **FREE** in Living Color.

SATURDAY, FEBRUARY 19
Shop and Save Every Day at **Western Auto**

Dimmitt Texas

COX TIN SHOP

SHEET METAL WORK
PLUMBING
LITTLEFIELD, TEXAS

BUSINESS and INDUSTRIAL DIRECTORY

ALLEN ELECTRIC
Complete Motor Service
REBUILDING • REWINDING
REPAIRING
Located At Rear Of Motor Machine Shop
PHONE: 385-5472
812 East Ninth Street
Littlefield Texas

MURRAY'S MULESHOE JEWELRY

To Rest Assured use **SAFETY DEPOSIT BOX** Protection
FIRST STATE BANK
Dimmitt, Texas

MONTGOMERY WARD
SALES AGENCY
326 Main Muleshoe
Phone 272-4561
Phama Anderson
Owner

Ford FARM - INDUSTRIAL EQUIPMENT
TRACTORS
DIESEL GASOLINE
2 to 5 PLOW SIZES
FRANCIS IMPLEMENT
Muleshoe, Texas

LA-Z-BOY
Lounge
TV Viewing
Full Bed Reclining
Johnson Furniture
Muleshoe, Texas

In Business To Serve You
Weddings
Funerals
Parties
Holidays
Phone 272-4340
Mildred & Gid Howell
DECORATORS 216
FLORAL
Muleshoe, Texas

Harvey Bass Appliance
YOUR DEALER FOR
• FRIGIDAIRE
• RCA VICTOR
• MOTOROLA
PHONE 272-3030
Muleshoe, Texas

YOUR DISTRIBUTOR FOR
TEXACO
SAM FOX
PRODUCTS
PHONE 272-4688
MULESHOE, TEXAS

McANALLY JEWELRY
Littlefield, Texas
323 Phelps
WATCHES DIAMONDS
CHINA CRYSTAL
FRANCISCAN POTTERY
COMPLETE GIFT LINE
WATCH REPAIR
BRIDAL GIFTS

Your **BUICK OLDSMOBILE DEALER**
BROCK MOTOR
Muleshoe, Texas

Eobb's
MULESHOE'S COMPLETE DEPARTMENT STORE
QUALITY MERCHANDISE FOR THE ENTIRE FAMILY
MULESHOE, TEXAS

COMMERCIAL PRINTING
EARTH NEWS-SUN

Social PRINTING
EARTH NEWS

Real and Artificial Flowers--Corsages
Pot Plants--Banquets
Funeral Designs
520 S. FIRST ST.
BEAVER'S FLOWERLAND
Ph. 3-1160--Muleshoe
and
EARTH FLORAL
Ph. 7-4341--Earth

Quality PRINTING
EARTH NEWS

SINCE 1949 **REDI-MIX CONCRETE SAND-GRAVEL**
Wire Mesh-Reinforcing Steel-Expansion Joints
KILLINGSWORTH Builders Supply
LUMBER - PAINTS - ETC.
Phone 647-3434 or 647-3593 Box 715 Dimmitt, Texas

Western Auto
The Family Store
DIMMITT, TEXAS

YOUR DEALER FOR
Massey-Ferguson
GLENER Combine
ALLIS-CHALMERS
B & P Implement Co.
DIMMITT, TEXAS

Party Line
Mrs. Leon Foster and David attended a shower in Plainview Friday night honoring Mrs. Walter Elam.
Ruthie and Gienna Truelock, Portales, N. M., spent the weekend with their aunt, Mrs. Mary Gilmore.
Diane Jackson visited over the weekend with her parents, Mr. and Mrs. Wayne Jackson in Fort Worth.
Weekend visitors in the home of Mr. and Mrs. Crill Bulls were Mr. and Mrs. Delwin Brooks and daughter, Paducah, and Mr. and Mrs. Scott Faulkenberry, Floydada.

DOWN BOY DOWN... This photo of Coach James Hundley of Kress, snapped as he cheered the Kress boys to victory Friday night, looks as though he might be doing a television commercial, such as "We Tarreyton smokers would rather fight than switch."

Stay in the heart of (downtown) TEXAS

AMARILLO
4th and Polk Streets
3 Minutes from Hwy. 66, 87, 287 & 440
Phone DR 6-4571

CORPUS CHRISTI
Shoreline & Schatzel
Overlooking Beautiful Corpus Christi Bay
Phone TU 4-4815

EL PASO
Main & Kansas Sts.
Three Blocks from Mexican Border
Phone 533-8741

AUSTIN
11th and San Jacinto Sts.
Across from Capitol Building
Phone GR 6-7151

FT. WORTH
10th & Houston Sts.
Across from City Hall & Federal Center
Phone ED 6-2011

HOUSTON
Texas & Fannin Streets
15 Minutes from New Astrodome Stadium
Phone 228-0911

Everything you need is DOWNTOWNER and at the DOWNTOWNER you're there

- Free parking
- Free Ice
- Heated swimming pool with patio
- Free television and hi-fi music
- Oversize double beds
- Meeting and banquet rooms
- No charge for children under 13 occupying room with parents

For your traveling convenience, use our **FREE WIRE RESERVATIONS** service between Downtowners

DOWNTOWNER MOTOR INNS
"THE SIGN OF HAPPY TRAVEL"

For the newest free directory of Downtowner Motor Inns, please write to:
The Downtowner Corporation
202 Union Avenue
Memphis, Tennessee 38103

Approximately 120 Attend Father-Daughter Box Supper

The girl scout father-daughter sweetheart box supper was held Monday night at 7 p. m. in the Springlake-Earth School Cafeteria, with approximately 120 attending.

Miss Mary (Skeet) Anderson, District Advisor for the Caprock Girl Scout Council, was mistress of ceremonies during the program.

Girl Scout troop no. 178 was in charge of the flag ceremony. They led the group in singing "America" and in repeating the pledge to the flag.

Buddy Hedges gave the invocation.

Each girl presented her father with a valentine kiss prior to showing her beautifully decorated valentine box.

A centerpiece made by troop no. 178 and 308 was constructed from a tree branch, having valentine trinkets hanging from it. Troop no. 398 also made a centerpiece, which was of large red valentines surrounded by pink cupid dolls. Troop no. 185 dressed dolls of the various countries and placed them around the room.

Venessa Simmons and Annette Hodge from troop no. 185 sang

a duet entitled, "This Is My Country."

A short talk on the purpose of the Juliet Lowe Friendship Fund was made by Welda Barton. She made the presentation of the money collected in troop #85 to the fund. Others representatives from the various troops making the presentation were Marianne Messer from troop no. 178, Kathy Winders from troop no. 308, and Terri Harper from troop no. 398.

Several games were played. Miss Anderson led a game entitled "Who stole the chickens."

The brownie troops sang "The Brownie Smile Song."

Mrs. Wilson Lewis presented Miss Anderson with a gift from all the girl scout troops.

Leaders and assistant leaders attending were Mrs. Billy Hodge, Mrs. Norman Hinchliffe, Mrs. Sam Barden, Mrs. Marcus Messer, Mrs. Richard Stockstill, and Mrs. Wilson Lewis. Committee mothers present were Mrs. C. C. Goodwin, Mrs. John Aguirre, Mrs. Phillip Haberer, and Mrs. Donald Street.

At the close of the program the fathers sang, "Good night, Ladies" to their daughters.



BEAMING BEAUTIES WITH BECOMING BOXES BULGING WITH BEFITTING GOODIES are just a sample of the lovely Girl Scouts with beautifully decorated boxes of food who gathered for the father-daughter box supper at the school cafeteria Monday night. They are Kim Kelley, Kelley Hayden, LaAnna Sulser, Welda Barton, Annette Hodge, and Venessa Simmons.

LAZBUDDIE NEWS

by Mrs. C. A. Watson

Gene Fox, a farmer in the area was injured in a car-truck collision Saturday, east of Farwell on farm road 145. Fox attempted to miss a truck turning in front of him when the accident happened. He was thrown several feet from his car which was a total loss according to the Patrolman investigating the collision. When Fox turned to the right to miss the truck, his car was caught under the rear of the truck. Gene Fox has two sons and one daughter attending Lazbuddie school. Mrs. Gene Fox is assistant helper in the Lazbuddie Lunch room. Gene Fox was carried to the Memorial Hospital in Clovis for treatment and released.

Mr. and Mrs. Edgar Hartley visited in Brownwood the past weekend with relatives.

Annie Gargile visited recently with her brother and his wife, Mr. and Mrs. Morris Goodwin, Lubbock.

Mrs. Quinn Weaver reported Monday February 14, that her father, Odie Wilson 76, remained about the same in a hospital in Boonsville, Arkansas. Mr. Wilson suffered a stroke the first of last week. Mr. and Mrs. Finis Jennings

visited in Quitaque Monday through Friday of last week with their son and family, Rev. Ale E. Jennings.

Linda Weaver, daughter of Mr. and Mrs. Quinn Weaver and Jeri Wiedebush, son of Mr. and Mrs. R. Wiedebush, exchanged wedding vows in the Methodist church in Clovis recently. The double ring vows were read by Rev. Gillinham of Clovis. Linda is a 1964 graduate of Lazbuddie high and Jeri is a graduate of Muleshoe high. The couple are at home in Lubbock where they plan to continue their schooling at Texas Tech.

High school principal Harley Ethredge was crippled, while he was practicing ball with a group of boys in the Lazbuddie gym Friday evening of last week.

Gearidene Ferguson, Friona, was guest at the Young women's Chapter of homemakers in the Lazbuddie homemaking cottage Tuesday evening of last week. Mrs. Ferguson decorated a valentine cake for the members while they watched. Mrs. Ferguson is the former Gearidene Phipps, daughter of Mr. and Mrs. Charlie Phipps, Muleshoe.

Mrs. Morris Nowlin and her daughter, Mrs. Ronnie Shafer were in Lazbuddie Saturday night, taking pictures at the Sweetheart Banquet held in the Lazbuddie cafeteria.

Scotty Windham reports that the FFA boys did well with their

RA's Enjoy Skating Party

The Leonard Lane RA's enjoyed a skating party Saturday night at the Plainview skating arena. The group enjoyed hamburgers and Cokes prior to the skating party.

Attending were Larry Thomas, Gary Lynn Davis, Kevin Anderson, Larry Clark, David Hinchliffe, Jerry Anderson, Bryan Huley, Mike Hardwick, Lonnie Adrian, Jessie Cole, and Hershel Huley.

Scouts Practice Flag Ceremony

Girl Scout Troop no. 178 met Thursday in the school cafeteria to practice the flag ceremony, which was their part on the program at the father-daughter sweetheart box supper Monday night.

Following their return to the scout hut, Marilyn Eagle served refreshments of cup cakes and punch to Kim Kelley, Kim Stockstill, Renee Clark, Laquitha Clark, Debra Schellar, Debra Weil, Nicola Conner, Terri Inglis, Lajuana Marshall, Merianne Messer, Franee Faver, Gay Ellis, Debra Schellar, and leaders Mrs. Richard Stockstill and Mrs. Marcus Messer.

exhibits in the Ft. Worth Stock show and received good prices for their stock shown.

HELLO WORLD

Mr. and Mrs. Joe Campbell announce the birth of a baby girl, born Monday, February 14, at 2:50 a. m. in the Plainview Hospital.

The infant has been named Jennifer Lee, and weighed 5 pounds, 1 ounce.

The couple are parents of one other child, Melissa, age 5 years.

Mr. Campbell is employed at Campbell Cotton Gin Co.

Mr. and Mrs. Leroy Bolinger, Gentry, Arkansas, announce the arrival of a baby boy born on February 5 in a Fayetteville Hospital.

Juspin Lee, as the infant has been named, tipped the scales at 7 pounds.

The couple are parents of one other child, a daughter, Michelle, four years old.

The Bolingers are former Springlake residents, and moved to Gentry recently where Mr. Bolinger is engaged in ranching.

PARTY LINE

Karen Barton, student at Texas Tech College, Lubbock, visited over the weekend with her parents, the Weldon Bartons, other relatives, and friends.

Visitors Sunday afternoon in the L. C. Winders home were Mrs. Phelps Murrell and Mrs. Jay Winders.

Mrs. W. A. McCool left Friday for a visit in Cheko, California, with her mother and other relatives.

Mr. and Mrs. Ross Middleton

Springlake Baptist Church Honor Seniors With Dinner

The senior class of Springlake-Earth School was honored Monday, February 14, with a bar-b-que dinner in the Springlake First Baptist Church.

The welcome was given by Mrs. Lowell Walden, R. B. Hall, Way and Baptist

College, was the guest speaker. He expressed the need for all students to further their education in a major field of their choice.

Bar-b-que, baked potatoes, beans, tossed vegetable salad,

strawberry shortcake, coffee, and tea were served from tables laid with a lovely white linen cloth, centered with a red floral arrangement. Red hearts and red cupid's were laid beside the plates and the glasses were atop white lace hearts.

The seniors, Mr. and Mrs. Earl Parish, Mr. and Mrs. James Washington, Superintendent and Mrs. Bill Mann and Mr. and Mrs. R. B. Hall were the special guests.

Congratulations...



JUNIOR HIGH BASKETBALL SQUAD

WE ARE MIGHTY PROUD OF YOU.....

Now Let's Take District

AT HART THIS WEEK END...

WE ARE WITH YOU ALL THE WAY.....

EARTH INSURANCE

PERRY MARTIN PHONE 257-3461

Congratulations...



To The Hard Playing

JUNIOR HIGH BASKETBALL TEAM

WE ARE PROUD OF YOUR SHOWING

IN THE LOCAL TOURNAMENT AND WISH YOU ALL THE SUCCESS AT THE DISTRICT TOURNAMENT AT HART THIS WEEK END.....

WERE BACKING YOU ALL THE WAY

PATTERSON BROS. GROCERY

SUPPORTING & BACKING THE EARTH TRADE TERRITORY...

YOUR FORD DEALER'S BIG FORD DRIVE IS ON!

Now save big on all our big, beautiful new '66 Fords! We're dealing to keep our Big Ford Drive moving at a stampede pace. Come test-drive one now!

Your choice of 19 models — sedans, hardtops, convertibles, wagons. There's something for everybody in the big Ford line... and big savings go with 'em all! Sixes and V-8's... just name the model you want and we'll deliver it equipped the way you want it at the price you want to pay!



Galaxie 500 2-Door Hardtop

JACKSON FORD, INC.

EARTH, TEXAS