

The FRIONA ★ STAR

VOLUME 52, NUMBER 32

SUNDAY, MAY 15, 1977

15 CENTS 16 PAGES PLUS SUPPLEMENT



Star Lites
By
Bill Ellis

WHILE ATTENDING the girls' state track and field meet last weekend in Austin, we met Coach Bill Stroman of Jourdanton. We had good reason for seeking him out, because his class A girls team, located just south of San Antonio, is nick-named the Squaws.

As far as we know, there is no other girls team in Region I that has the Squaws name besides Friona, and until this weekend, we knew of no other team in the state.

Stroman says he gave the team the nickname himself, when he first went to Jourdanton (pronounced Jer-dan-ton) in 1954. He currently serves as athletic director, coaches football and track in addition to girls basketball. The boys athletic teams are called Indians.

Jourdanton has an outstanding record in girls basketball. Stroman said that his teams have failed to win their district only about three times in the past 20 years.

Their girls team had qualified one representative, Melinda Dornak, to the state meet, in the 440-yard dash. She represented the "Squaws" well, placing second in the good time of 58.1. Coach Stroman said she was a junior.

Some of you girls' basketball fans have probably heard of Jourdanton before, whether or not you have heard they were the "Squaws." Melinda's older sister, Carolyn Dornak, was an all-state player there some years ago, and went on to star for the Wayland Flying Queens.

We thought you'd be interested, as we were, with this tidbit we picked up while covering our Squaws at Austin. Incidentally, the school colors at Jourdanton are—you guessed it—Red and White.

IT WAS QUITE AN experience to see the new Olympics-style scoreboard at the state meet. It flashes the times for the races while they are in progress, clicking constantly in hundredths of a second. When the race is over, the timing apparatus stops, and you know immediately the time for the race, unless it has to be adjusted, which is seldom.

Those attending the state meet this year were privileged to see some outstanding performances by the girls, all the way from class B through AAAA. A number of national records were shattered by our Texas tracksters.

If you don't think the sport is progressing, just realize that Friona almost won the class AA mile two years ago. Their time of 4:00.4 is still the school record. This year, it took a 3:53.8 to win the event. Tulla and Lubbock Cooper, Region I's best, came in fifth and sixth this year, with 4:00.0 and 4:00.7 respectively.

But Region I seemed to be plagued with getting the undesirable lanes. Friona drew lane eight for their 880-yard relay race and neighboring Bovina somehow got that assignment on all three of their great relay teams. Bovina officials thought this figured prominently in their outcome. The Fillies placed second in two events they expected to win, losing both in almost dead-heat finishes. This cost Bovina the state title.

We mentioned Dora Bentancourt. She had lane eight for her race. Other teams from this area drawing "unlucky eight" were Sudan, Slaton and Levelland. Vicki Cleveland of Dimmitt drew lane seven for the 80-yard hurdles finals. Levelland and Canyon had lanes six and seven for the 880-yard relay, conference AAA.

One might suspect that Region I was getting the short end of the stick when it comes to lane assignments. We definitely didn't get any favors this time around.

Temperatures

Date	Hi-Low
Saturday, May 7	85-53
Sunday, May 8	88-56
Monday, May 9	83-56
Tuesday, May 10	85-53
Wednesday, May 11	76-53
Thursday, May 12	78-53
Friday, May 13	75-53

Moisture: .13 inch on May 8; .08 inch on May 10; trace on May 11; .22 inch on May 12; .52 inch on May 13. Total for week—.95 inch.

Good Rainfall Is Reported In Area

Rainfall in the area during the past week has varied from an inch in the city of Friona to four inches at Bovina, with virtually everyone in the area getting beneficial moisture.

Friona's rainfall, conservative by the standards around the area, came to .13 inch late last Saturday, .08 Monday afternoon, .22 Wednesday night and .52 Thursday night.

The corresponding totals by the official weather recorder at Bovina

showed .5 inch Saturday, 1.6 inches Monday, .6 inch Wednesday, and .85 Thursday. In addition, another .3 inch had fallen after 8 a.m. in Bovina Friday morning, making it virtually four inches for the week.

The Rhea area received a good rain from the late Saturday rain, with 1.5 to 2 inches reported. Some fine hail was reported in that area, and also at Bovina, but hail damage was believed minimal, and limited

The Hub area had received 1.2 inch of rain prior to the Thursday night fall, and Lazbuddie had received 1.6 inches, and it was still raining when the report was being written.

The rainfall should highly benefit young crops, as well as assist planted crops in coming up. The only people beginning to yell calf rope were vegetable farmers in the Bovina area



INSPECTS CROPS...Herb Evans, District Conservationist of the Parmer County SCS, takes a look at the corn stand on the Kenneth McLellan farm southwest of Friona. Corn and a few other crops are

thriving due to the abundance of moisture received recently, but farmers are now hoping for a lull in the rain in order to continue cotton planting. (Photo by Bill Ellis)

City Calls Trash Hearings

Residents of Friona will be able to tell the city officials how they feel about the city's trash disposal situation during two public hearings set up by the city council during its meeting last Monday night.

The council, after discussing the status of the trash disposal system in Friona, decided to call the public hearings to let the city residents voice their opinions on the subject. "Maybe we can get the public's

opinion on this subject," Jake Outland, Friona City Manager, said Tuesday. "We know it will cost about \$75,000 to \$80,000." He was referring to the complete new trash container system the city is proposing. If Friona changed to this system there would be one container, or dumpster, to every two to three houses, which are picked up by trucks, doing away with the present system of having men dump each trash can into the trash truck.

Tentative dates set for the public hearings will be Monday night at 8 p.m. and next Monday, May 23, at 8 p.m. at the Friona Community Center.

Outland said this would give him time to obtain bids from several builders so the city could show the people just what it would cost them. In other business, the city fathers agreed to pay Buck Paige \$460 for repainting the interior of the Law Enforcement building. Outland said the only local bid received was for the sum of \$738.

The council also authorized the installation of a lawn sprinkler system at Prairie Acres by Colonial Turf Irrigation Company of Clovis, N.M., who had a bid of \$5,602. Mayor R.L. Fleming said a local bidder had reduced his bid by \$1,000 at the last minute but was still beat in the bid. "When you are spending the taxpayers' money you have to advertise for bids and accept the lowest of the bids received," the mayor said. "The purpose of advertising, asking for, or calling for bids is to get the low bid. If you always give the bid to a local man no

(Continued on Page 5)

School Schedule

Following is a schedule of events for the last two weeks of school to assist you in making plans:

Wednesday, May 18
Awards assembly for third and fourth graders at 1 p.m. in the Junior High Auditorium. Fifth through eighth grades awards assembly at 2:30 p.m. in Junior High Auditorium.

Thursday, May 19
All Friona School Bands will present a Spring Concert in the Junior High Auditorium, to begin at 8 p.m.

Friday, May 20
High School awards assembly at 2:30 p.m. in the High School Auditorium. Eighth grade playday at Clovis, top students announced.

Sunday, May 22
High School baccalaureate services at 8:30 p.m. in the Junior High School Auditorium.

Tuesday, May 24
Awards assembly for kindergarten through second grade at 1 p.m. in the Junior High Auditorium.

Wednesday, Thursday, May 25-26
School dismisses at 2:45 p.m. each day.

Thursday, May 26
Last day of school for all students. Eighth grade graduation at 8:30 p.m. in Junior High Auditorium.

Friday, May 27
High School graduation at 8:30 p.m. in Junior High Auditorium.

Landfill To Be Closed

City of Friona has applied to the State Department of Health Resources for continued operation of the North landfill site as a Type V Brush and Demolition disposal site with public hearing now imminent.

An inspection Thursday of this week by the department representative revealed that much rural garbage and putricible material are being deposited at the site. In order that the facility can be continued to be used in its best capacity.

For tree trimmings, construction material disposal, incombustible metals etc., a decision has been made to close the facility to public disposal.

Effective Monday, May 16, 1977, persons who have brush, metal, or other appropriate disposable materials must call the city offices, 247-2761 for disposal appointment.



MAYOR PROCLAIMS...Mayor R.L. Fleming proclaims this week as National Transportation Week in Friona by signing the proclamation last week. The mayor urges all citizens to lend their support to the State Department of Highways and Public Transportation. (Photo by Leon Watson)

Action Saves Hereford Boy

A 19-year old Hereford youth, Kevin Lea, probably owes his life to the quick action of a Friona man, who stopped to render aid last Wednesday and discovered Lea unconscious and in an unresponsive condition.

Artis Fallwell was driving southeast on FM 1731 when he noticed two men standing just off the highway, and then spotted a third lying on his back. The two flagged Fallwell, who turned around to check the situation.

He told the Friona Star he discovered that young Lea, an employee of West Texas Rural Telephone Company, had been

working with a crew laying an underground line, when they cut into a gas line.

Lea was attempting to plug the line when he became overcome by gas. When Fallwell arrived at the scene, he could not tell if the victim was breathing, and his eyes had rolled back.

Fallwell applied artificial respiration, pumping Lea's stomach and chest, and got the youth to breathing and coughing.

Fallwell then rushed Lea to Parmer County Community Hospital, where he was put under oxygen and kept until his condition stabilized.

Honor Students Named For 8th Grade Class

Honor students for the 1977 eighth grade graduating class at Friona Junior High School were announced Friday by Junior High principal Cecil Maddox.

Kipi Fleming, daughter of Mr. and Mrs. Ray D. Fleming, was named as the class valedictorian, having an average of 97.37.

Dana Smith, daughter of Mr. and Mrs. Danny Smith, is the salutatorian, averaging 96.25.

Class historian is Cindy Alexander, daughter of Dr. and Mrs. Robert Alexander, with an average of 96.00.

Other students in the top ten include Scott Butler, son of Mr. and Mrs. Stan Butler, averaging 95.37;

Dianna Wright, daughter of Mr. and Mrs. Jarrell Wright, 94.62; Susan Anderson, daughter of Mr. and Mrs. R.L. Anderson, 49.28; Chris Lyons, son of Mr. and Mrs. Mike Lyons, 94.25; Margaret Ramirez, daughter of Mr. and Mrs. Manuel Ramirez, 94.00; Mike Schueler, son of Mr. and Mrs. Herbert Schueler, 93.75; and Litia Rodriguez, daughter of Mr. and Mrs. Jesse Rodriguez, 93.12.

Miss Fleming was a participant in sports and won second in two track events at the district track meet this year. She was first chair in flute of the All-Regional Band in Lubbock this year and served as majorette of the Junior High School Band. Last year she was the band's drum

major. She has been on the honor roll, and has won several awards in the UIL meet this year.

Miss Smith has been attending school at Friona since the second grade. She has made every honor roll and has won several band awards. She made a "one" in solo flute for the last two years. She is active in the Methodist youth group, and Girl Scouting. She also participated in sports and ran track.

Miss Alexander was a twirler for the Junior High Band this year and received a "one" rating in the band festival this year in twirling. She also received a "one" in solo cornet. Her hobbies include gymnastics, music, swimming and reading.



KIPI FLEMING



DANA SMITH



CINDY ALEXANDER

Friona Man Donates Windmill To Museum

There's a new but old windmill at the Ranching Heritage Center of The Museum of Texas Tech University. It is a Starmill, manufactured by the Flint & Walling Manufacturing Company, Kendallville, Ind., about 100 years ago.

From sometime in the 1890s, according to oldtimers, it stood on New Mexico land owned by Calvin Talley, who farms north of Clovis and in the Friona, Texas, area.

After Talley's father, L.R. Talley, died at the age of 92 in 1971, his family in "cleaning up the home place" was ready to destroy the windmill when Hollis Horton, operator of Parmer County Pump Co. in Friona, volunteered to remove it to the Ranching Heritage Center.

The Center is a 12-acre outdoor exhibit of more than a score of authentic ranch structures depicting the history of ranching in the American West.

The windmill was brought to the center by Hollis, and it stands now behind the Barton House, a large home in the process of restoration. The Barton House depicts the coming of affluence to ranchers who persevered while other Ranching Heritage Center structures—log cabins, dugouts, and the dirt-floored picket and sotol house—demonstrate earlier days of ranching.

The Barton House is a suitable site for the windmill, for Talley said that it long served his family's eight-room residence where the parents reared ten children.

"The windmill pumped water for the family and the livestock," he said. His father farmed and ran some white faces, the number ranging between 100 and 500, which were bought in the winter to graze the wheat and then sold in the summer.

The Talleys purchased the New Mexico land in 1923 from a Mrs. Clack, and they were the first to break the grassland for farming. The Starmill was on the site when they purchased it, and the younger Talley said he was told it was put there in the 1890s.

Historian Robert C. Williams who is in charge of its restoration said, however, that there are indications that the windmill is older. Among the clues is the type of nails used.

The windmill was in use until 1949. It stands 48.6 feet tall. The mill wheel is 14 feet in diameter and has an alemite grease fitting, probably installed in the 1920s or 1930s. It has been restored with its original red, white and blue paint covering the cypress and white oak wood. There are eight blades still to be installed.

The Starmill is the fourth windmill at the Ranching Heritage Center.

An Eclipse, which was the most popular on the High Plains, was donated by Jonah Laubhan of Follett, Texas. It was built in the early 1900s and stood near Stratford, Texas.

The unusual Walpole, donated by Ronald Weaver, Petersburg, Texas, was located near Ulysses, Kansas. It

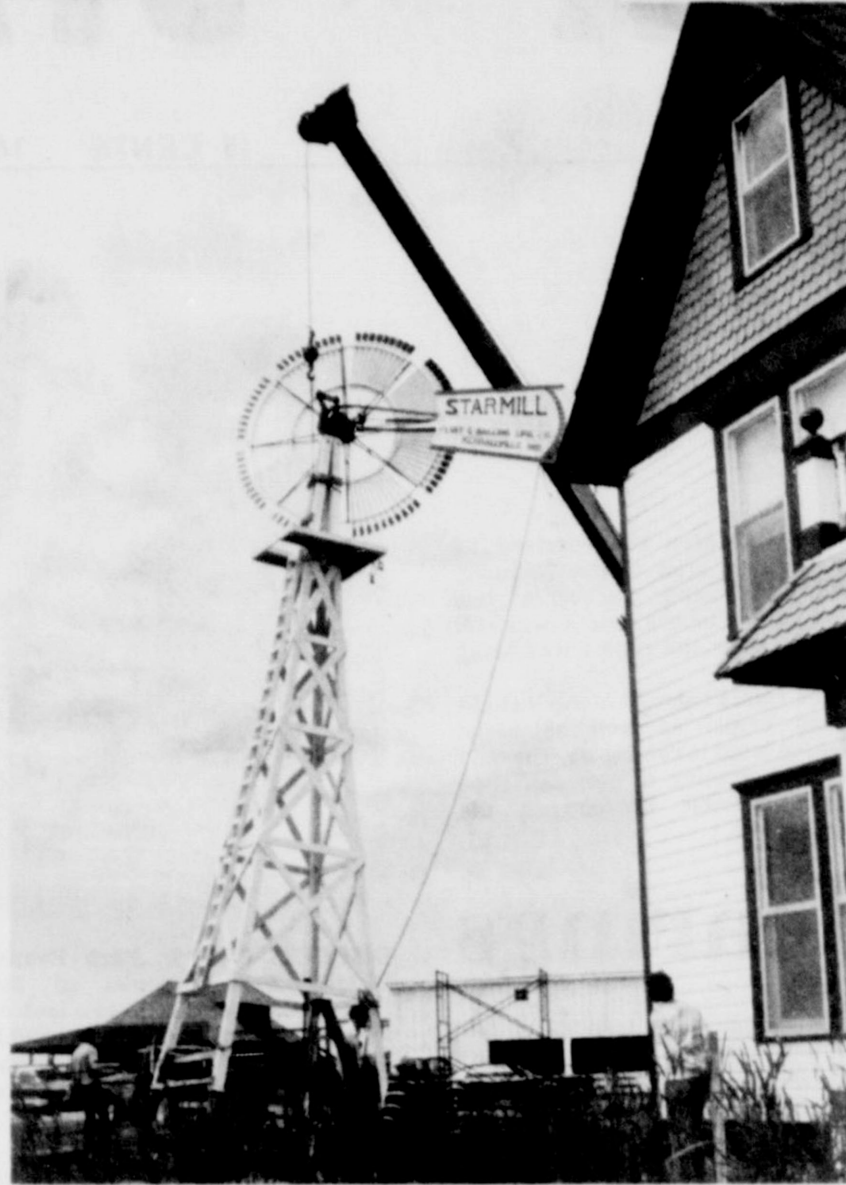

STARMILL....A windmill that could be 100 years old is swung into place behind the Barton House at the Ranching Heritage Center of The Museum of Texas Tech University. The center is an authentic outdoor exhibit depicting the history of ranching in the American West.

Behind the mill is, left, the Reynolds-Gentry Barn and the U Lazy C Carriage House. All structures once served ranches and have been authentically restored. The 40-foot windmill with its 14-foot wheel was manufactured in Kendallville, Ind. (Tech Photo)

is unusual in that its sails remain opposite the pivot, or away from the wind.

An improved Clipper Windmill, once marketed by Montgomery Ward, was located near Presidio, Texas. Donated by an authority on windmills, Billie Wolfe of Lubbock, it has been restored and serves the George M. Slaughter and the Pitchfork Ranch pens and the Reynolds-Gentry Barn at the Ranching Heritage Center.

A ground tumbler windmill, built of scrap lumber and bois d'arc wood, was found by Ms. Wolfe near Cooperston, Okla., and donated by Mr. and Mrs. Roy Hunsinger of Mountain View, Okla. Commonly seen in open prairie country, these windmills had the disadvantage of being unable to pivot as the wind changed and had to be situated to catch prevailing winds.

Ms. Wolfe, who has spent a lifetime studying and photographing windmills, said the first in the

United States were manufactured in the early nineteenth century although their history is dated at several centuries earlier. Although the Persians are credited with their invention, there are indications, she said, that they may have been built even earlier in other cultures. Ms. Wolfe is a member of the emeritus faculty at Texas Tech University.

The Friona Star

Published Every Sunday
at 916 Main Street
Friona, Texas 79035
Second class postage paid at Friona,
Texas 79035

SUBSCRIPTION RATES
Parmer County, adjoining counties,
\$6.30 per year. Elsewhere, \$7.87 per
year.

Bill Ellis, Editor & Publisher
Leon Watson, Managing Editor
Vickie Copley, Production Supt.
Laura Nell Coffey, Bookkeeper

Friona Flashbacks

....from the files of The Friona Star

45 YEARS AGO—MAY 13, 1932

There was a good deal of surprise manifested in Friona last week when the report became current that Friona had changed postmasters over Sunday, and that John A. Guyer, retiring postmaster, had given place to his successor in office, Dayton H. Hanson. Mr. Guyer has served the people of Friona and its locality for the past seven or eight years.

++++

35 YEARS AGO—MAY 8, 1942

C.E. McLean, cashier at Friona State Bank, will leave Monday for induction into the U.S. Coast Guard, it was announced this week. Frank Truitt has also enlisted in the Coast Guard and is waiting his call to active service. Wright Williams expects to be inducted into the Coast Guard on June 1.

W.L. Edelson this week purchased the Magnolia Petroleum Company agency for the Friona territory from Wright Williams, who has enlisted in the Coast Guard. Mr. Edelson has been superintendent of schools in Friona for the past four terms, and resigned his position recently.

++++

30 YEARS AGO—

(Entire 1947 issue missing from Star files.)

++++

25 YEARS AGO—MAY 8, 1952

High school graduation will be held on Thursday, May 22 in Friona. Valedictorian of the graduating class of 18 has been announced as Joyce Ann Miller, daughter of Mr. and Mrs. Roy V. Miller. Salutatorian is Johnny Parker.

With lots and lots of talk about party conventions during the past weeks, and with record turnouts at both the precinct and county conventions, it all terminated with the Republicans and Democrats having one point in common—both county conventions agreed on sending un instructed delegations to their respective state conventions.

++++

20 YEARS AGO—MAY 9, 1957

Named to represent Friona this year at Texas Boys and Girls State are Linda McLean and Leon Massey. The two were selected by the Friona American Legion and the

American Legion Auxiliary, the sponsoring organizations. Selected as alternate to Boys State was Jerry Hinkle.

Honor students of the 1957 graduating class at Friona High School have been selected and plans are being made for baccalaureate and commencement exercises. Compiling a 94.88 grade average during her four years in high school, Janice Miller has been named valedictorian of the class and Phyllis Treider, who had a 94.17 average is salutatorian. The ranking of the honor students is just opposite of the two when they were in the eighth grade. When they were graduated into high school in 1953, Phyllis was valedictorian and Janice was salutatorian.

candidate, Bill Millen of Muleshoe was favored by Parmer County voters, with 579, to Clayton's 508 and Nelson's 410.

++++

10 YEARS AGO—MAY 11, 1967

Honor students for the 1967 graduating class at Friona High School were announced this week by high school principal Raymond Cook. David Lewis Smith, son of Mr. and Mrs. Lewis L. Smith, is the class valedictorian. Terri Lynn Wilson, daughter of Mr. and Mrs. Elroy Wilson, is the salutatorian. Smith compiled a four-year average of 96.43, compared to Miss Wilson's 95.89. Third-ranking student, Mac Hancock, had a four-year mark of 95.67.

++++

5 YEARS AGO—MAY 18, 1972

The top students in Friona's eighth grade graduating class were announced the past week by Tom B. Jarboe, junior high school principal. Troy Messenger is the class valedictorian, with an average for the year of 96.875. He is the son of Mr. and Mrs. Steve Messenger. Lisa Edelson is class salutatorian, compiling an average of 95.750. She is the daughter of Mr. and Mrs. Von Edelson.

Wendell Gresham Says.

REMODELING?

Don't forget your Insurance Coverage. Your insurance should reflect the replacement cost of your home. If it doesn't and disaster strikes, you may find yourself under-insured and in a real mess. Get your insurance coverage up-to-date now!

Ethridge-Spring
Agency
Inc.



WELCOME TO FRIONA



Newcomers in Friona this week are Bobby and Susan Hix. Bobby and Susan were raised in Friona but they did not know each other at the time. Susan is a 1976 graduate of Friona High School and Bobby is a graduate of Eunise, N.M. Susan is the daughter of Mr. and Mrs. Wendell Garner and Bobby is the son of Donna Walker. After leaving Friona he lived in Amarillo eight years and Eunise three years. He returned to Friona in 1976 where he met Susan. They were married March 12 of this year and he is employed at HI-Pro.

CLASS OF '88

Plan now for your child's future!

Will you be able to help your children attend college when they are ready? Open a passbook savings account today or invest in certificates of deposit for your child's future education.

PEOPLE
COME
FIRST

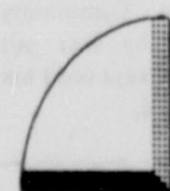

FRIONA STATE BANK

BROCKMAN SALES

Automotive Parts And
Irrigation Supplies

HOUSER

GROCERY & MARKET

ROCKWELL BROS. AND CO.

"LUMBERMEN"
Lumber, Paint & Tools

REEVE CHEVROLET

New And Used Cars
FRIGIDAIRE APPLIANCES



To The Editor

Friona Star
916 Main
Friona, Texas 79035

Dear Sir,
The Oasis Shrine Club thanks your paper for the news items appearing in your paper concerning the Childrens Diagnostic Clinic held on April 30, 1977.

For your information, the Clinic was considered to be a huge success with some 97 children being examined by the visiting doctors.

We owe thanks to many people who helped make the Clinic possible through their donations and particularly Sugarland Feed Yards, Inc., who furnished a beef, Dimmitt Meat Company, who furnished free processing, Travis McPherson for painting, and the Ink Spot for printing. Our winners for the drawing were Cynthia Easterwood for T.V., Cameron Guley for 1/2 beef, Oswalt Industries for 1/2 beef, and Mrs. W.E. Willis for painting.

Again our thanks.

Yours very truly,
Oasis Shrine Club
Rex W. Easterwood, President

Courthouse Notes

Instrument Report Ending May 4, 1977 in County Clerk Office, Bonnie Warren, County Clerk

WD, James R. Berry, Farwell Equip. Co., Inc., tract out W 1/2 Sec. 32, T9S, R1E

WD, J.D. McMillan, Gilbert R. Boatman, lot 12, Blk. 8, M&F Add., Friona

WD, Gilbert R. Boatman, Marcos Madrid, Jr., lot 12, Blk. 8, M&F Add., Friona

WD, Marcos Madrid, Jr., Joe Aguirre, lot 1, Blk. 85, Friona

WD, Farmers Home Adm., Alejo L. Ramos, Jr., lot 7, Blk. 2, Ridgeview, Friona

WD, Lawrence W. Garth, James R. Lovell, Part W-pt. Sec. 26, T2N, R4E

WD, J.G. Evans, Wayne Garth, Sec. 6, Harding-S 1/2 Sec. 26, T2N, R2E-part Sec. 2, T1N, R2E

WD, Wayne Garth, James R. Lovell, Sec. 6, Harding-S 1/2 Sec. 26, T2N, R2E-part Sec. 2, T1N, R2E

WD, D.C. Herring, Santos Rando, Jr., W 70 ft. lots 7 and 8, Blk. 9, McMillen & Fergus, Friona

WD, Frio Development Co., Jack Roye Straw, W 73.5 ft. lot 2, All E 25 ft. lot 3, Blk. 3, Western Add., Friona

WD, Lubbock Cotton Oil Co., William G. White, 15 ac. out LG. 549, Pt. of OT Farwell

WD, J.W. Wright, Avis L. Henry, 2 ac. out NE-cor. of S 1/2 Sec. 15, Blk. B, Synd.

WD, William G. White, Interstate Fertilizer, Inc., 15 ac. out Lg. 549, Pt. OT Farwell

WD, Dollie Aldridge, et al, Hurshel Harding, et al, Pt. lot 32, all lot 31 and N 1/2 lot 30, Blk. 27, Farwell

WD, Marston G. Mars, Michael E. Chaney, 72 ac. out NE 1/4 Sec. 26, T1N, R4E

WD, A.L. Glasscock, et al, James D. Roach, tract out lot 11, Blk. 1

WD, Joe Don Stevens, Juan Trevino, lots 11, 12, 13, Blk. 15, Bovina.

MARRIAGE LICENSES
Manuel Gonzales and Hilda Ornelas.

Seminar Set

A farm commodity seminar on agricultural export potential crop conditions and cattle market analysis will be held Monday at 8 p.m. in the Friona Community Center.

The seminar will be conducted by A.G. Industries of Kansas City, Missouri, with the director of market research, Dick Emilson, presenting the program, assisted by director of marketing, Jim Bruton.

Topics of interest to local farmers will be supply and demand forecasts, world conditions, U.S. projections, exports, forecasts on price projections and hedging. Current conditions of corn and beans will be discussed, also.

A question and answer session will be conducted to clarify unclear matters on subjects covered during the program.

The yo-yo comes from a Filipino jungle fighting weapon. The word means come-come!

"Old foxes want no tutors."
Thomas Fuller



With Prices Like These...
WHY PAY MORE!

PRICES GOOD WEEK OF MAY 14 - MAY 20



Meat Specials
OSCAR MAYER WIENERS OR Beef Franks 1 LB. PKG. \$1.19
OSCAR MAYER Ham & Cheese 8 OZ. PKG. 99¢
OSCAR MAYER Chopped Ham 8 OZ. PKG. \$1.19
OSCAR MAYER SLICED Cooked Ham 4 OZ. PKG. \$1.39

U.S.D.A. GRADE A COUNTRY PRIDE
Whole Fryers 49¢ LB.



WRIGHT'S HICKORY SMOKED SLICED Bacon LB. \$1.09
FRESH 73% LEAN Ground Beef LB. 79¢
PAN-READY Cut-Up Fryers LB. 59¢

U.S.D.A. GRADE A FRYER Breast LB. \$1.09
U.S.D.A. GRADE A FRYER Drumsticks LB. 89¢
U.S.D.A. GRADE A FRYER Thighs LB. 89¢
(Back-Neck-Wing) DUMPLING OR Stew Pack LB. 29¢

MORTON MEAT (BEEF - CHICKEN - TURKEY)
Pot Pies 489¢
8 OZ. PKGS.

DEL MONTE BLUE LAKE WHOLE
Green Beans 3 \$1
303 CANS

ELLIS
Vienna Sausage 389¢
5 OZ. CANS

MARS FUN SIZE CANDY 1 LB. \$1.29

GLADIOLA CORN BREAD MIX 6 OZ. 2/33¢

GLORY RUG CLEANER 24 OZ. \$2.09

KRAFT ITALIAN Dressing 8 OZ. BTL. 59¢

HOLSUM Salad Olives 10 OZ. JAR 79¢

SPRAY STARCH Easy-On 22 OZ. CAN 69¢

SHASTA CANNED DRINKS 12 OZ. 3/49¢

LUCKY LEAF PUMPKIN PIE FILLING 18 OZ. 47¢

Produce Specials
GRAPEFRUIT 17¢
LB.

CUCUMBERS 17¢
LB.

GREEN ONIONS 2/27¢
BUNCH

Dairy And Frozen Food
MORTON FROZEN DINNERS 11 OZ. PKG. 49¢
MORTON HONEY BUNS 9 OZ. 37¢

BROASTED CHICKEN
serve chicken at its finest
BROASTED CHICKEN
It's our specialty!
It's cooked to order fresh to finished, in just minutes, especially for you.
Also: CORN DOGS AND BURRITOS
PHONE 247-3343
for families, for friends, for all occasions

RANCH STYLE
Pinto Beans 5 \$1
300 CANS

VALUABLE COUPON
LAUNDRY DETERGENT
Oxydol \$2.19
KING SIZE BOX
One Coupon Per Customer
Coupon Expires May 21, 1977

HOUSER VENTURE GROCERY
902 N. MAIN ST. PHONE 247-3343
FRIONA, TEXAS
AFFILIATED
GUNN
VENTURE
FOODS

READ and USE

CLASSIFIED ADS ★

PH. 247-2211

Reader Ads—First insertion, per word 10 cents
Additional insertions (no copy change), per word 8 cents
Minimum charge \$1.50
Classified display (boxed ads—9 pt. type under a specific heading, 1 column width only—no art or cuts. Per column inch \$1.50

Cards of Thanks—same as classified word rate, minimum charge \$1.50

DEADLINE for classified advertising in Sunday's issue—5 p.m. Thursday.

Check advertisement and report any error immediately; The Star is not responsible for error after ad has already run once.

PRO AUCTION SERVICE

★ Any And All Types Of Sales
AUCTIONEER CLERK
LARRY POTTS LELAND GUSTIN
PHONE PHONE
295-6633 247-2146

AUTOMOTIVE

FOR SALE BY OWNER....
1973 Volkswagen Super Beetle. Low mileage, air conditioner, radio, heater and back window defroster. Like new. Call 247-3398 or 247-2743. 26-tfnc

FOR SALE....Yamaha 175.
Good condition, runs excellent, ideal dirt bike. Call 247-3501 after 4 p.m. 32-2tc

FOR SALE

FOR SALE....Electrolux
vacuum cleaners. New and used. Sales and Service. Phone 247-3156. Mrs. L.R. White, 806 Ashland Avenue. 43-tfnc

FOR SALE....Good used
electric eye-level range. Coperton. Contact Cindy at 247-3270. 27-tfnc

FOR SALE....Antique dresser,
Sears washer and dryer, hardly used. Many other items. 303 West 7th. 32-1tc

FOR SALE....14x70 American
1973-3 bedroom, 2 bath. Excellent condition. 238-1104 after 6 p.m. 32-4tc

FOR SALE....1974 Chevrolet
pickup, fully loaded. Also like new Johnson CB base and antenna. Also 1974 Honda 250. Call 265-3358 after 6:30 p.m. 31-2tp

FOR SALE....14x72 mobile
home, 2 Bedroom, 2 Bath. Call 238-1293 after 5 p.m. on weekdays. 28-tfnc

FOR SALE....Large gold
Whirlpool ref.-freezer, \$150. Long flowered divan, \$50. Call 265-3817, Kitty Bailey. 31-2tc

FOR SALE....12 gallon
triangle shaped aquarium. Like new, complete accessories. Will sell or trade for electric typewriter. Call 247-2508 30-tfnc

The Bubble Bed Shop
Changing Hustling Hereford to the town without a back ache. Water beds complete located next to the Hereford Fruit Market, North 385. Call 364-7777. 32-1tc

FISHING WORMS....50
cents a dozen. Gladys Wilson, 302 E. 7th. Call 247-3436. 29-6tc

FOR SALE....12 gauge
pump action shot-gun. Springfield Model 67, variable choke. Like new. 247-3906. 32-2tc

CARDS OF THANKS

We would like to thank the volunteer workers who helped make our drive the success that it was. Special thanks to Friona State Bank and the City of Friona for the use of their meeting rooms.

Evelyn Ball
Res. Cancer Crusade
Chairman
32-1tc

Dirty Carpets got you down? Steri-Steam carpet care can remedy your problem by removing dirt, sand and other residues, using the injection, extraction method.

THOMAS CARPET CLEANING SERVICE
Phone 238-1640 or 238-1330 (Res.) 29-4tc

THANK YOU

The fifth grade would like to say thank you to Janet Woodard for her great presentation of slides on May 4, and to Dale Westbrook for the program on drugs he gave on May 11. We really enjoyed it.

Fifth Grade
32-1tc

THANK YOU

The family of Chester Varner would like to extend a heartfelt thanks to each and everyone who helped in any way after the loss of our loved one. It means so much to us and will not be forgotten.

The Families of
Chester Varner
32-1tc

GARAGE SALE

GARAGE SALE....1305 W.
5th. Friday and Saturday, May 20-21. Hours-9 a.m.-6 p.m. 32-1tp

GARAGE SALE....Friday
and Saturday, May 13-14. Six miles west on FM 1731. Household items, children's clothing, men and women's clothing, lamps, knick-knacks, etc. 9 a.m. to 6 p.m. 32-1tc

PATIO SALE....Saturday,
May 21, 10 a.m. to 7 p.m. Clothes, toys, household and decorative items. 1305 Virginia. 32-1tc

HELP WANTED

HELP WANTED....L.V.N.
part time. Apply in person. Immediate opening. Prairie Acres, 201 East 15th Street. 30-tfnc

I NEED A BABYSITTER
FOR THE SUMMER MONTHS. To babysit in my home. Prefer high school age. Call 247-2016 after 6 p.m. 31-tfnc

TAGCO Industries Inc. is now hiring people with millwright experience. Workmen's Compensation and family insurance plan. Job interviews each afternoon from 3 to 5. TAGCO Industries Inc., Hwy. 60, West across from Armour, 806-357-2222. 31-2tc

HELP WANTED....House-
work, general cleaning. Phone 247-3004. 32-1tc

HELP WANTED....Electrician's
helper. No experience necessary. Apply at A&A Electric. John Allen, Jr., West Highway 60, 247-3007. 32-tfnc

WORK WANTED

WANTED....I will mow
lawns and do all types of yard work this summer. Stan Powell. Call 247-2893 after 4 p.m. 30-3tp

REAL ESTATE

FOR SALE....two new
three-bedroom houses. Two baths. Refrigerated air. Forced-air heat. Fireplace. Fully carpeted. Well insulated to save on heating. Double garage. 1703 West 10th and 1621 West Ninth. Shown by appointment. Phone 247-3290. 12-tfnc

MARSHALL M. ELDER
Representing
Rushing Real Estate
Phone 247-3907
Res. 247-3266
Box 775, Friona, Texas
31-tfnc

FACTS OF LIFE

If the trend that has been established for the last several years continues, we will continue to experience significant inflation. Therefore there will be no better time to buy a new home, trade your existing home for a larger one or buy instead of rent. It will get more expensive instead of cheaper. DO NOT WAIT. Call Today.

Ask about one of these super buys.

2329 sq. ft. near high school spread over a den, 3 or 4 bedrooms, 1 1/4 baths for only, \$37,000.00.

3bedroom, 1 bath home with an apartment that can help make the payments for only, \$16,000.00.

Representing

Hi-Plains Savings & Loan

"SERVICE is our only Business"



Carrol Gatlin
247-3641

CARROL GATLIN LAND CO.

102 E. 11th Office 806-247-2745
FRIONA, TEXAS 79035

ANNOUNCEMENTS

Friona Lodge No. 1332
7th & Ashland
Slated Meeting
1st Tues. 8 P.M.
J.W. Dixon-WM
A.L. Outland-Sec

ROOFING
Composition Shingle
Free Estimates.
Call after 3:30 p.m., 364-4911
Hereford, Texas
32-3tp

PRICE OR QUALITY?
We can give you quality prints at a reasonable price at Shafer's Photo, 218 W. 2nd, Muleshoe, Texas. Portraits, Commercial, Weddings and Copy Work.

Ronnie & Pat Shafer
Shafer's Photography
218 W. 2nd,
Muleshoe, Texas 79347
Phone 806-272-3487
3-tfnc

For Your Merle Norman
Cosmetics
Call
Sondra Nichols
247-2587
Or Now, At a New
Location:
RUTHIE'S
38-tfnc

NOW....In Friona. You can come direct to us and discuss a mortgage loan, or a home improvement loan. Let us visit with you on any financial question you might have. Tri-County Savings & Loan, 106 West Ninth, Friona. 16-tfnc

Need To Count Calories?
Try Hilcoa Protein Powders "No Hunger Pains." Completely Natural Sources. Rated above Gov't Specifications. Call Ruth Renner, 247-2540. 1tc

HOME INSULATION--Now
booking orders for Insul-Cel insulation. Insul-Cel is a lightweight, loose-fill cellulose material that is machine-blown into both attic and walls to create a thermal wall that will save up to 50 per cent of energy cost. Cellulose fiber insulation is more efficient and more economical than any other type of insulation. Nine out of ten homes do not have sufficient insulation to meet government standards. Insul-Cel blown over your existing insulation will bring quick results on your utility bills. Also, we are now installing wind-driven turbine vents that will greatly reduce attic heat and give up to 25 per cent savings on your summer cooling costs, for \$89.95 a pair. Avoid the coming rush and higher prices. For a free estimate now, call Border Insulation, 481-9257, Farwell. 32-3tc

THE SAW SHOP
I will sharpen all circular saws and all type hand saws.
Don Phelps
905 Grand
Call 247-3787
32-4tc

New Red Skelton Clown Needlepoint Kits. Sesame Street Latch Hook Pillows and Rug Kits. Over 500 colors needlepoint yarns.
DAN'S OF CANYON
31-3tc

BUSINESS DIRECTORY

ADAMS DRILLING CO., INC.

WATER WELL DRILLING

Layne Pumps, Inc. Pump & Gear
Zimatic Sprinklers Head Repairs
Sales & Service All Makes

Dial 247-2731
Friona, Texas

used cow
dealer is.....



Friona Bi-Products
For 7 day a week dead stock removal. Call 247-3032 Collect

TELEX

CLOVIS HEARING AID CENTER HEARING AIDS

★ Batteries ★ Molds ★ Free Hearing Test
SERVICE ALL MAKES
403 E. 14th Phone 763-6900 9tfnc



NEED A HOME LOAN?
SEE **FIRST FEDERAL**
FIRST FEDERAL SAVINGS
AND LOAN ASSOCIATION
801 Pile St.
762-4417
Clovis, New Mexico

FARM SALES

★ FREE APPRAISALS
★ GUARANTEE ALL CHECKS
B & B AUCTION SERVICE
SEE AT **BIG NICK'S**
BIG NICK (806) 238-1614
HOUSTON BARTLETT 225-6699
FRIONA NIGHT PHONE 247-3084

SHUGART COUPON

THURSDAY, MAY 19th
HOUSER GROCERY
9th & MAIN



9
WALLET SIZE
COLOR PORTRAITS
99¢
ASK ABOUT
FREE
8 x 10
OFFER
Extra charge for GROUPS

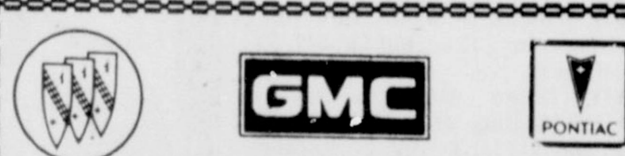

BUICK-GMC-PONTIAC

JOHN ORSBORN

30 YEARS IN HERFORD

See Us And SAVE

142 Miles Ave. Hereford, Texas
Phone 364-0990



TRI-STATE INDUSTRIES To **RANCHERS, FARMERS**
and **FEED LOT OPERATORS**

We Provide...
Complete Dead Stock Removal — Prompt, Sanitary Service
Trucks Sanitized For Your Protection
FOR FREE PROMPT PICKUP — PHONE 763-5513
TRI-STATE INDUSTRIES Call Collect
CLOVIS, NEW MEXICO (505) 763-5513
Buyers of Fat, Bones, Restaurant Grease and Hides

Wednesday Service Held For Dennis Auburg

Funeral services for Dennis M. Auburg, 63, were conducted Wednesday, May 11, at 3 p.m. in the First Assembly of God Church in Friona, with Rev. Thomas Blevins, pastor, and Rev. J.M. Ashley of Stratford officiating.

Auburg died Monday, May 9, at 6:30 a.m. Burial was in the Friona Cemetery under the direction of Parsons-Ellis Funeral Home.

Born September 14, 1913 at Estelline, Texas, he was married to Zell Seymour on August 16, 1933 in Turkey, Texas.

Auburg had been a member of the Assembly of God Church since childhood. Was a resident of Friona for the past fourteen years, moving here from Turkey.

He was employed at Friona Consumers.

Survivors include his wife Zell of the home, one daughter, Mrs. Joe Green of Garland, Texas, and one son, Raymond Auburg of Friona.

Also surviving are his mother, Mrs. Ruth Auburg of Brownfield; three sisters, Mrs. Kenneth Marshall, Brownfield, Mrs. Genell White of Midland and Mrs. Magdalene



DENNIS AUBURG

Stevenson of Strasburg, Ohio; four brothers, Joe of Burke, Va., Billy Bob of Midland, Charles of Knox City and David of Albuquerque, N.M.

Seven grandchildren also survive.

Pallbearers were Vincent Gallagher, Melvin Southward, Edward White, Jr., Conrad Mullin, Allton Robbins and James Procter.

Rites Held For J. Miller

Funeral services for Johnny R. Miller, 52, who died Thursday at Clovis Memorial Hospital were conducted at 2 p.m. Saturday from Steed Memorial Chapel with the Rev. David Crow officiating, assisted by Cecil Bunch of Bovina.

Burial was in Sunset Terrace Memorial Gardens in Farwell under the direction of Steed-Todd Funeral Home.

Miller was born Nov. 26, 1924 in Hamlin, Texas, and came to Clovis when he was nine years old. He had been a longtime resident of Clovis and sold office supplies in the area for the past 20 years.

He owned and operated State Line Office Supply for four years, and previously sold office supplies for the Bovina Blade.

Miller was a member of the First Baptist Church in Melrose, a member of the Melrose Masonic Lodge number 39 and the American Legion. He served in the U.S. Navy in World War II.

Survivors include his widow, Wanda of the home in Farwell; two daughters, Mrs. Margaret Sain of Clovis, and Junelle of the home; one



JOHNNY MILLER

son, Johnny Roy Miller of Las Cruces; one sister, Mrs. Francis Reese of Santa Barbara, Calif.; and two grandsons.

Pallbearers were Hugh Moseley, Prentice Mills, Bob Anderson, Dan Savage, Glen Gosner and Clyde Montague. Honorary pallbearers were all relatives, friends and Masonic brothers.

MUSICAL MERCHANDISE SALE ONE WEEK ONLY

May 16 Through May 21
Sugarland Mall,
Hereford, Texas

Pianos Organs Guitars
Amplifiers Accordions

CLARK MUSIC COMPANY
SUGARLAND MALL
HEREFORD, TEXAS

Elson E. Clark - Owner

Clayton Continues Conservative Acts

State Rep. Bill Clayton of Springlake has turned the tables in the Texas House of Representatives where he is serving his second term as Speaker.

The tradition is that one day in May every year that the Legislature is in session be observed as Speaker's Day.

On that day in the past, the Speaker was honored by employees, House members, lobbyists and

friends and presented gifts. Long-time members tell tales of trucks backing up to the Capitol and unloading large numbers of personal gifts for the Speaker.

When Rep. Clayton became Speaker in 1975, he made it known that he would accept no personal gifts. In fact, he determined that he would pay all costs for the special day himself.

On May 2, Speaker's Day 1977 was observed under the same conditions Clayton imposed in his first term. Beginning with a reception for more than 700 employees of the House and staff of members, the Speaker, personally paid for the events of the day.

At noon, 11 former Speakers attended a luncheon at the Capitol and were later introduced during the House session. That evening there was a reception for the 24 chairmen of the House committees and their wives.

Hearing...

(Continued from Page 1)

one else will bid because they know they won't get it."

Fleming referred to a letter published in the Star about not accepting local bids, he said if a local man always knew he was going to get the bid he could cost the taxpayers a lot of money.

A resolution declaring May 16-21 as National Transportation Week was read, and, on behalf of the local State Highway Department, the council adopted a resolution for Friona's Transportation Week.



Don't Gamble on your Crop Income

Buy a Crop Hail Policy today

inquire now!

C.L. LILLARD
PH. 247-3320
DAY or NIGHT

Where do you want the freezer in your new Amana refrigerator...

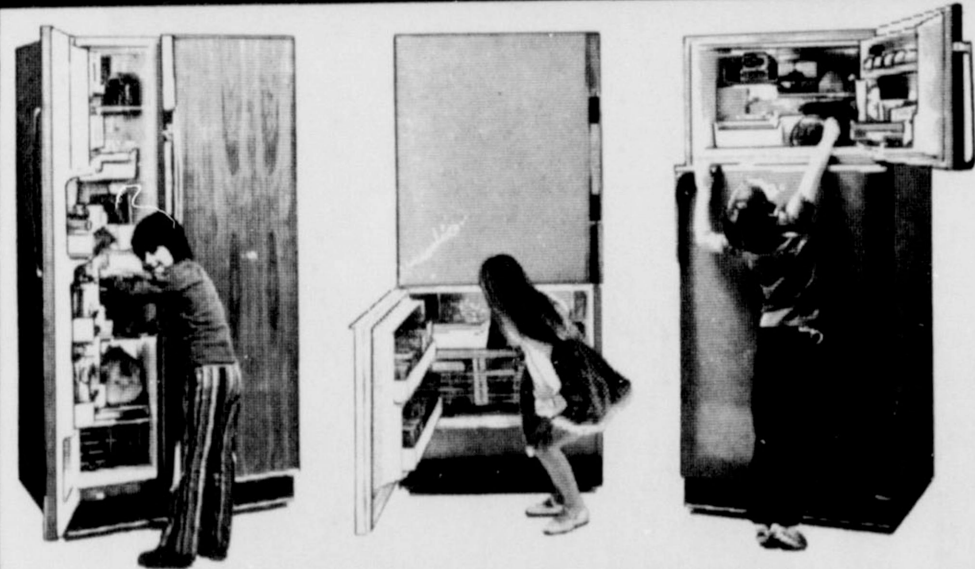

on the side? on the bottom? on the top?

Amana gives you a choice

If you want your zero degree freezer on the side, there's the Amana Side-by-Side. Or you can have it on the top or the bottom. They're all Free-O-Frost in both the refrigerator and freezer.

And every Amana has two independent temperature

controls, one for the freezer, one for the refrigerator. There's a "refrigerator-within-a-refrigerator" that keeps meat fresh up to twice as long as an ordinary meat keeper. In most models. And a high-humidity compartment that keeps vegetables fresh up to three weeks in 22 and 25 ft. side-by-side models.

Come and look at the choices Amana has for you. Then choose the one you want from gold, avocado, coppertone or white.

Optional add-on Ice Maker free, if purchased during month of May. Hurry, quantities are limited.

WHITE'S AUTO

W. HWY 60

Friona



FATHER'S DAY SPECIAL Photographer Will Be In E & R SUPERMARKET Tuesday, May 17th

SPECIAL 1 5x7 49¢

10:00 a.m. til 6:00 p.m.
1 SPECIAL PER FAMILY

WHEN QUALITY COUNTS... COUNT ON US!

PRICES GOOD WEEK OF MAY 14 THRU MAY 20

<p>QUALITY MEATS That's Our Specialty</p> <p>ROUND STEAK \$1.45 LB.</p> <p>WILSON'S FRANKS 12 OZ. PKG. 73¢</p>	<p>ARMOUR VIENNA SAUSAGE 5 OZ. CAN 2/79¢</p>
<p>QUALITY PRODUCE On Your Shopping List</p> <p>TOMATOES LB. 39¢</p> <p>BANANAS LB. 23¢</p> <p>YELLOW ONIONS LB. 25¢</p>	<p>KRAFT BAR-B-QUE SAUCE 18 OZ. BOTTLE 69¢</p> <p>GOLD MEDAL FLOUR 5 LB. BAG 69¢</p> <p>CROWN MARINA BATHROOM TISSUE 4 ROLL PKG. 89¢</p>
<p>FROZEN FOODS at Stock-Up Prices</p> <p>CHUN KING SHRIMP EGG ROLLS 12 COUNT 69¢</p> <p>MORTON GLAZED DONUTS 6 COUNT 79¢</p> <p>BORDEN ICE CREAM 1/2 GAL. \$1.29</p>	<p>WHITE SWAN TEA BAGS 16 COUNT 39¢</p> <p>OUR DARLING WHOLE KERNEL CORN 17 OZ. CAN 3/89¢</p> <p>TIDE GIANT SIZE \$1.37</p> <p>DR. PEPPER KING SIZE 6 PACK 79¢ PLUS DEPOSIT</p>

E & M SUPERMARKET

OUR AIM IS TO PLEASE IN EVERYWAY
WE GIVE GUNN BROS. STAMPS

WE ACCEPT USDA FOOD STAMPS

PHONE 247-2250

WE DELIVER

DOUBLE STAMPS ON WEDNESDAYS WITH PURCHASE OF \$2.50 OR MORE

Candid's From The Girls' State Meet



RELAXIN' TIME....The four members of Friona's 880-yard relay team are shown relaxing on the Astro-Turf at the Memorial Stadium

in Austin about an hour prior to their event last Friday. From the left are Janice Peak, Cindy Cleveland, Paige Osborn and Jatón Widner.



WINNING STYLE....Jeanine Brown of Bellville, right, flashes a smile as she hits the tape to win the 880-yard relay in the state finals in a record 1:41.7 timing. The Friona Squaws

finished fifth, even though running their best time of the year, 1:44.1. Janice Peak, in the left hand, is shown anchoring the Squaws' team.

Tele-Photos By Bill Ellis



GROUND RULES....The starter in the state meet is shown going over some aspect of the race with Cindy Cleveland, leadoff runner for the Squaws' 880-yard relay team. Miss Cleveland, a junior, was running in her second state meet in the event.



SAD TIME....A moment of sadness hit the Squaws' 880 relay team following their race last Friday, when two members of the team realized they wouldn't be running with the foursome any more. Jatón

Widner, center, wept quietly, while Sylvia Malouf, left, and Paige Osborn offered consolation. In the background is Cindy Cleveland. Janice Peak is seated in the foreground.



SPECIAL PARLEY....An official in the state track meet is shown conferring with third lap runners on the 880-yard relay teams, as to their lanes. Contestants in lanes six through eight were asked to step off the track for a moment while the race was begun.



BATTLE FOR LEAD....Paige Osborn, left, has just taken the baton from Cindy Cleveland, barely visible behind her, for the second lap of the 880 relay race. She is almost neck and neck with Barbara Reece of Bellville, the team that won the event.



GOOD PASS....Jatón Widner, left, and Janice Peak are shown making a perfect baton pass, as Miss Peak sets effort put forth by members of the relay race. The contestants' faces, and the straits in their muscles attest to the



Rhonda Rhodes, Riley Armstrong United In Double Ring Ceremony

Rhonda Lynn Rhodes of Bovina became the bride of Riley Anderson Armstrong of Roswell, New Mexico on Saturday, May 7.

The double ring ceremony was performed in the Bovina Church of Christ by Cecil Bunch, minister.

The bride is the daughter of Mr. and Mrs. Thomas Rhodes, Jr. of Bovina. The bridegroom is the son of Mr. and Mrs. B.B. Armstrong of 2602 Gaye Drive, Roswell, New Mexico.

The church was decorated with an arch in the center of the altar. The arch was flanked on either side by spirals holding yellow tapers. Baskets of white and yellow spider mums, white gladiolus, and daisies completed the church decorations.

The Church of Christ Wedding Chorus from Friona presented the musical program. Selections included "Come Share My Life," "Wedding Song," "The Lord Bless You and Keep You" and "Twelfth of Never." Miss Lana Thraillkill of Corpus Christi, Texas was soloist. She sang "Evergreen."

As the bride was presented in marriage by her father, she wore a gown of antique ivory chiffon and

re-embroidered alencon lace encrusted with pearls, veiled over peau-de soie. The gown featured an empire waistline, high neckline, long, fitted sleeves and a trumpet skirt. Unpressed pleats swept to a wide chapel length train.

The bride's veil fell from a matching calot of lace and pearls. Her cascade bouquet of yellow and white daisies, stephanotis, baby's breath and accented with yellow roses, was carried atop a Bible, which her mother had carried in her wedding.

Carrying out bridal tradition, she carried the Bible that her mother carried in her wedding for something old. Something new was her wedding gown. She borrowed the veil from a cousin, Mrs. Arvin Weaver of Austin and wore the traditional blue garter. She wore pennies in her shoes that were minted in the year of their births and borrowed a sixpence from Mrs. Mike Gencarelli of Lufkin, Texas.

Mrs. Greg Bell of Bovina was the matron of honor. Other bride's matrons were Mrs. Ben McCain of Amarillo and Mrs. Alton McCormick

of Lubbock.

Miss Pat Shehan of Lubbock and Miss Marilyn Holder of Pampa were bridesmaids.

Jim Stokes of Roswell, New Mexico, cousin of the bride, served as best man. Groomsmen were Alan Rhodes of Bovina, brother of the bride, J.P. White IV of Roswell, Fred Romero of Hondo, New Mexico and Larry Martin of Lubbock.

Ross Kerns of Booker, Texas was the usher. Lisa McCall of Houston, cousin of the bride was the flower girl.

Jody Bailey of Albuquerque, New Mexico, cousin of the bride, was ring bearer.

The feminine attendants wore yellow opulent organza dresses featuring capelets trimmed with narrow yellow lace. They carried nosegays fashioned of white daisies and lemon leaf with soft yellow streamers.

The flowergirl was attired similar to the other feminine attendants. She carried a piquant basket of yellow petals.

The bride's mother wore a turquoise chiffon coat with a beaded silver midriff which concealed a matching chiffon empire waisted dress. The coat was edged at the sleeves and neck in marabou and a yellow rosebud corsage provided the final touch.

The bridegroom's mother wore a long sleeved raspberry chiffon dress, accented at the sleeves and neckline with white lace. She wore a corsage of white rosebuds.

Mrs. Jayson Grimsley presided at the guest register.

A reception was held in the Fellowship Hall of the church following the ceremony.

The table was covered with a floor length yellow cloth bordered by small tucks stitched at intervals with yellow embroidery. The yellow cloth was topped with a sheer white on white medallion patterned cloth which was a memento from a trip to Spain. The edge of the table was draped with a garland of plumosus held at intervals by yellow bows.

A silver epergée held an arrangement of spider mums, gladiolus and roses. Punch and nuts were served from silver appointments by Mrs. Kim Rundell and Lauri Stokes, cousin of the groom from Roswell. The three-tiered bridal cake, decorated with white lattice scroll, was crowned with fresh flowers. Between columns separating the tiers was a miniature vase holding fresh flowers.

Members of the houseparty were Mrs. A.M. Wilson, Mrs. Vernon

Willard, Mrs. William Gromowsky, Mrs. B.L. Marshall and Mrs. Laurence Widner.

For a wedding trip to Las Vegas, Nevada, the bride wore a one piece yellow jumpsuit. She wore yellow accessories and a daisy corsage.

The couple will reside at 5203 A. 18th, Lubbock, after May 14.

The bride is a 1974 graduate of Bovina High School. She will graduate from Lubbock Christian College in August with a bachelors degree in education.

The bridegroom is a 1974 graduate of New Mexico Military Institute and attends Lubbock Christian College at the present time.

Two Frionans To Graduate From AC

Amarillo College commencement exercises will be conducted Friday, May 13, for 536 candidates.

Ceremonies will include graduates from the College of Arts and Sciences, School of Biomedical Arts and Sciences, School of Technology and School of Vocational Arts at 8 p.m. in the Amarillo, Texas, Civic Center Auditorium.

Dr. Kenneth W. Wheeler, provost and professor of Rutgers University in New Brunswick, New Jersey, will deliver the main address.

Charles D. Lutz, Jr., AC president, will conduct the program and present the Board of Regents, as well as present diplomas and confer degrees.

Two residents of Friona will receive certificates and degrees this spring.

Janis Auburg will receive a certificate of completion. Cecilia Denney will receive an associate in applied science degree.



Mrs. Riley Armstrong

Associates Met In Gromowsky Home

Ladies from Friona and Bovina met Tuesday afternoon in the home of Kathryn Gromowsky in the Hub Community for their monthly New Mexico Christian Children's Home Associates meeting.

Refreshments of strawberry and pineapple tarts were served by the hostess assisted by Lynda Grimsley.

Attending from Friona were Mona Campbell, Jyl Grimsley and Lynda Grimsley.

From Bovina were Betty McClaran, Wilma Johnston, Monta McClaran, Kathryn Gromowsky, Mable Ellison and Hazel Bowers.

Two guests from Friona were Joann Baize and Linda Trussell.

Twenty-two pairs of canvas gloves and twenty-two packets of flower seed that the children will use for hoeing cotton and their garden during the summer were brought by the members upon request.

Monta McClaran, who is the area wide president over all the New Mexico Christian Children's Home Associates, reminded members on May 16 at noon in the home, there will be a covered dish luncheon

honoring the children who are seniors this year.

Everyone made dough art mushrooms that will be sold at the crafts fair in the fall with proceeds going to the home. Lynda Grimsley presented the program of "Bringing Sunshine To Others" using humorous old-fashioned black and white pictures. The members also enjoyed seeing actual pictures of the home which Lynda had taken. They enlightened many on the needs and living conditions of the home. Lynda expressed that they are a service organization to the New Mexico Christian Children's Home in Portales and that their goal as an associates group is to provide assistance of any kind desirable by the Board of Directors of the home.

Anyone interested in the caring and sharing of the Associates group should contact one of the members for more information.

Newly-elected officers are Lynda Grimsley, president; Kathryn Gromowsky, vice president; Jinx Snead, secretary-treasurer; and Monta McClaran, project chairman.

Becky Walker To Graduate From SPC

A list of 319 candidates for graduation has been announced by Jerry Barton, dean of admissions and registrar at South Plains College, Levelland.

Commencement services for the prospective graduates will begin at 10 a.m. Friday, May 13 in Texan Dome.

Featured speaker for the 19th annual commencement will be Dr. Glenn E. Barnett, executive vice president at Texas Tech University.

Also during the exercises, Dr. Marvin L. Baker, SPC president, will present the Vera Sue Spencer

Award, given annually to the woman student who has been selected as the woman who has done the most during the academic year to promote student morale and school spirit.

L.C. Kearney Jr., chairman of the SPC board of regents, will present diplomas and certificates to the graduates. Nathan Tubb, academic dean, and Frank Hunt, technical-vocational-occupational dean, will certify the graduates.

Becky Gene Walker of Friona will receive an associate degree in science.

Amarillo. Zimmatic center pivot center of the growing Southwest.

Now that Lindsay's new Amarillo plant is fully on-stream, you can move up to one of the world's most popular center pivots... without even leaving the High Plains!

As your Lindsay dealer, we know that having Lindsay as "home folks" means we can count on them for more of the little things that make the big difference. Like important savings on transportation and delivery costs when you buy a new Zimmatic. Or getting spare parts to us overnight if we happen to run out in a busy season. Along with a Texan's concern for reputation and quality!

To help keep your new Zimmatic out front, Lindsay has backed their people up with the finest in equipment and facilities. Precision machines, high-speed tube mills... everything, including one of the world's largest hot-dip galvanizing plants. They're turning out the full line. Long-span and low-pressure models. Zimmatic 410 hill climbers and full-section systems. Plus brand-new Zimmatic Corner Pivots™ and Corner Guns™ that bring once-skipped-over acres into production.

When you need another center pivot, be sure to see us... your full-service Lindsay dealer... for a genuine Zimmatic. Now made in Amarillo, the Southwest's new center pivot center.

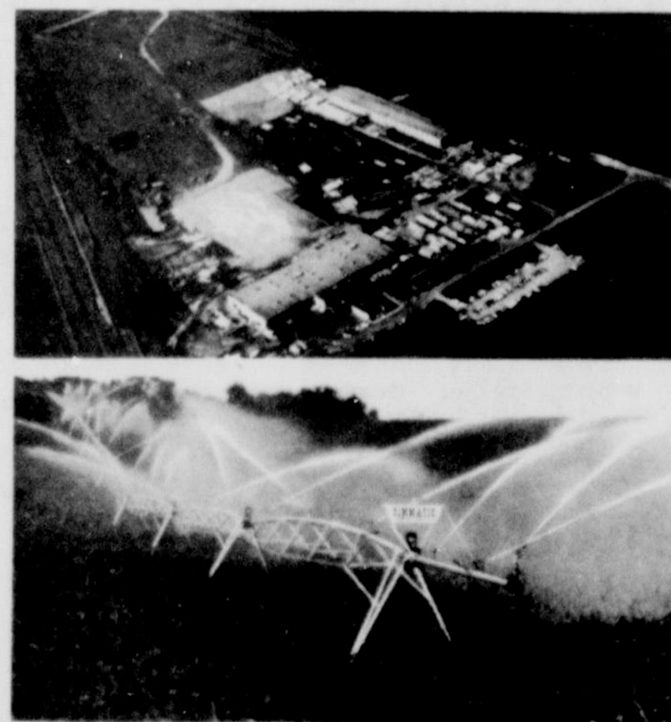

LINDSAY

BIG T SPRINKLER SERVICE

Division of BIG T PUMP CO.

HEREFORD: Don Caillouet - 364-0353

DIMITT: Rick Ward - 647-4171

FRIONA: S.D. Baize - 247-3311

**Protect your
profits
with
Chief!**

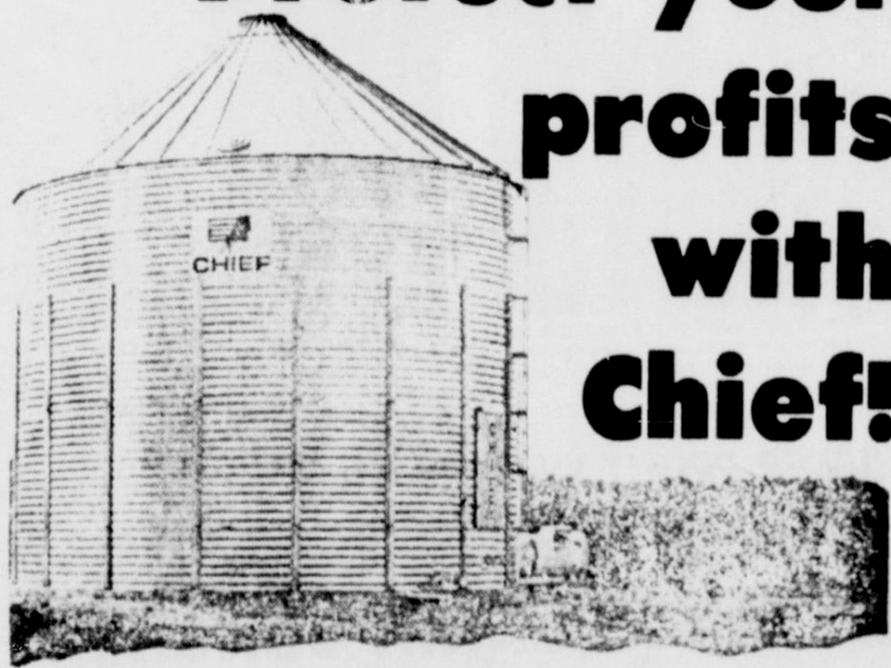

**WESTERN AG
SALES** CO., INC.

formerly Gifford-Hill retail outlets

FARWELL, TEXAS

\$\$\$\$\$\$\$\$\$\$\$\$\$\$\$\$
IRRIGATION & GRAIN MANAGEMENT
THE PROFIT MAKERS
\$\$\$\$\$\$\$\$\$\$\$\$\$\$\$\$

KEN COLE

Office 481-3316

Home 247-3065

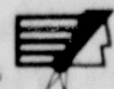

The Grain Management System

The Making Of A State Champion...



GET SET....Tammie Smith of Lazbuddie, shown at right, in her set position just prior to the class B 880-yard dash at the state meet. At the far left in lane one is the class B defending champion, Janet Doyal of Lohn. Gloria Carter of Meridian is in lane two.



FIRST LAP....Just completing the first lap of the 880-yard dash for class B, Lazbuddie's Tammie Smith is beginning to move up on the outside. From right to left are Gloria Carter, Meridian, Debbie Bolk, Texline, Janet Doyal, Lohn, and Miss Smith.



WINNING SPRINT....Tammie Smith, left, is shown as she completed her finishing kick, to beat Debbie Bolk, right, by .4 second and take the state title in the 880-yard dash. Miss Smith, who had won the District 1-B title, finished second to Miss Bolk in the regional, but turned the tables at Austin.

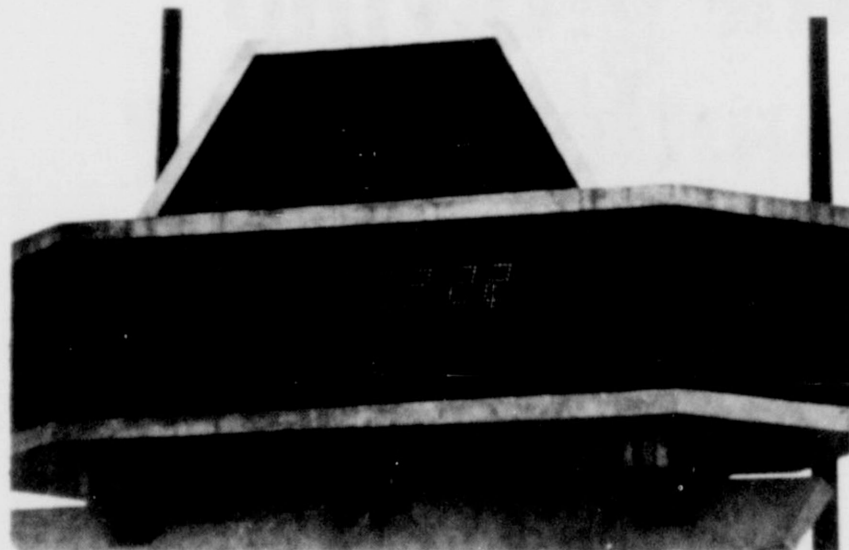

WINNING TIME...The ultra modern scoreboard at Austin's Memorial Stadium was an attraction of its own for participants and spectators at the state meet. Tammie Smith's winning time, an unusual 2:22.22, was captured by the Star's camera as it was flashed at the conclusion of the race.



CONGRATULATIONS.... Debbie Bolk of Texline was the first person to offer congratulations to Lazbuddie's Tammie Smith at the conclusion of the 880-yard dash at the state meet in Austin last weekend.

++++
880-Yard Run: 1. Tammie Smith, Lazbuddie, 2:22.22; 2. Debbie Bolk, Texline, 2:22.6; 3. Temple Kallus, Holland, 2:25.3; 4. Gloria Carter, Meridian, 2:25.8; 5. Janet Doyal, Lohn, 2:26.7; 6. Lou Mewhinney, Holland, 2:27.8.

Lazbuddie Girl Wins State Title

Unheralded and unsung, Tammie Smith of Lazbuddie was the lone gold medal winner from Parmer County at the track and field portion of the UIL girls state meet last weekend in Austin.

A junior this year at Lazbuddie High School, Tammie staged a strong finish in the class B 880-yard dash to nip region one champion Debbie Polk of Texline at the wire. Miss Smith's winning time was registered at 2:22.22.

"I wasn't tired at all. I was surprised to have that much left," Tammie said immediately after the race in an interview with the Friona Star representative.

"I didn't have any idea I'd win. I didn't know what any of the other regional times were. I just wanted to stay close to Debbie (the Texline runner who had edged her at the class B regionals)."

Tammie did a good job of staying with Miss Polk, and when the two rounded the final curve and headed down the final 100 yards, she suddenly decided that she could win the race, and reached down for a good finishing kick that left the Texline runner a surprised second.

A check of the records showed that Miss Smith, the daughter of Mr. and Mrs. Gene Smith of the Lazbuddie community, had the second best qualifying time of the eight state meet entries. Debbie Polk's time was the best, just barely ahead of Tammie's.

In addition to beating her Region I rival, the Lazbuddie lass also unseated Janet Doyal of Lohn, the 1976 state champion in the event, who placed fifth this time around.

Miss Doyal and Gloria Carter of Meridian helped set the pace during the first lap, with Miss Smith content to run about fourth, although there never was much distance between any of the runners.

At the beginning of the final lap, Miss Polk began to pick up the pace, and Tammie wisely followed her lead. The other two girls dropped back to third and fourth, and then in the final steps of the race, Tammie charged past the Texline girl for the medal.

The 880-yard dash was the second running event of the day on Saturday. Miss Smith thus had her day's work finished early (by 1:20 p.m.) and could relax and enjoy the rest of the day's festivities.

At the regional meet, Tammie had also entered the 220-yard dash, long jump and high jump, having placed second in those events at district. She also ran on the school's mile relay team, which was second in district, and was a member of Lazbuddie's district champion girls golf team.

This week, her cousin, Charleson Steinbock, will be an entry for LHS in the hurdles at the boys state meet.

The winning time was almost four seconds better than her previous best, 2:26 at the regional meet.

"I decided at the first of the year that I wanted to run the event in under 2:23," Tammie concluded following her triumph. She achieved everything she set out to do—and more.



HAPPY WINNER....Tammie Smith smiles for the Star's camera as she stood on the winner's stand and clutched her gold medal, symbolic of winning the state title in the 880-yard dash.

LEGAL NOTICE

Notice Is Hereby Given That The Parmer County Commissioners Court Will Convene As A County Board Of Equalization On Monday, May 23, 1977. At 2:00 P.M. In The County Courtroom.

Any And All Persons Who Wish To Meet With The Board Of Equalization And Discuss Any Tax Matters Will Be Welcome.

Signed: James P. Fortenberry
County Judge
Parmer County, Texas 2tc

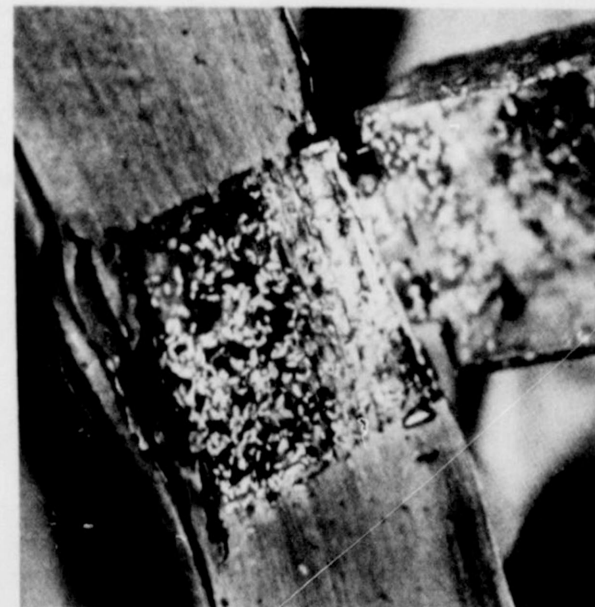

JON RESISTANCE — Greenbugs caged on a susceptible sorghum leaf suck the leaf's juices and inject deadly toxins, killing the formerly healthy tissue. Grain-producing capacity is cut dramatically.



GREENBUG RESISTANCE — Fewer greenbugs live on the leaves of NK hybrids with greenbug resistance. Greenbugs do not kill the tissue. The plants tolerate the presence of these aphids, but grain yields are seldom affected.

GET HIGHER PROFIT YIELDS WITH NORTHROP KING GREENBUG RESISTANCE GRAIN SORGHUM

- ★ NK-2779... Medium Late Maturity, Semi-Compact Heads.
- ★ NK-2778... Medium Late Maturity, Strong Stalks, Roots
- ★ NK-2884... Full-Season Maturity, High Production Hybrid, Heat Tolerance.

★ WE STILL HAVE PLENTY OF CORN AND SUNFLOWER SEED AVAILABLE



- ★ DRYLAND MAIZE
- ★ HAY GRAZERS

HARRELL MAYS
PHONE 247-3477

Savings GALORE!

AT WILHELM
TV &
APPLIANCE

What a deal
WE'VE GOT FOR YOU!

BIG THREE DAY SALE

SAVE MONEY NOW!

Thursday, Friday, Saturday

May 19 - 20 - 21 Open Till 9 p.m. on Thurs.

Come In And
Register For A FREE

TAPPAN
Microwave Oven



Save Time,
Energy And
Money With
A Full Size

FREE
COFFEE & COKES

Come In And Burst One Of The Many Balloons
Located All Over Our Store. Each Balloon
Contains A Cash Discount On Merchandise
Purchased During Our Big Sale.

Quasar TV
CLEARANCE

\$
OFF

Quasar 12 Portable **\$100⁰⁰**
COLOR TV Off

100% Solid State "Service
Miser" Chassis
Bright, Sharp Picture
Uses less energy than a 60 watt
light bulb
Lightweight—weighs only
28 lbs.



NOW ONLY
\$268⁸⁸

Quasar 19 Color TV

100% Solid State "Service
Miser" Chassis
Brilliant, Sharp Picture
Picture Control
Sharpness Control
Automatic Fine Tuning



Now only
\$368⁸⁸

Console Color TV

2 Only 23" Quasar Only **\$569⁹⁵**
1 Only 25" Quasar Only **\$599⁹⁵**
1 Only 25" Quasar Only **\$620⁵⁰**

SPEED QUEEN
Built better to last longer.

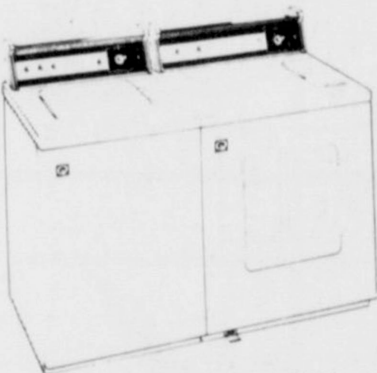

SAVE
\$85⁰⁰

NOW ONLY
\$620⁰⁰

Model FA6011 GREEN ONLY

ALL PRICES CUT ON
FEDDERS
Room Air Conditioner

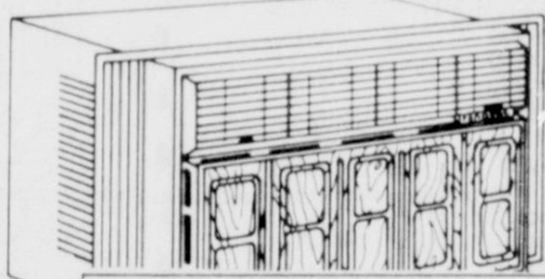

Our entire stock
will be specially
tagged for this sale.

TAPPAN
Microwave
Oven

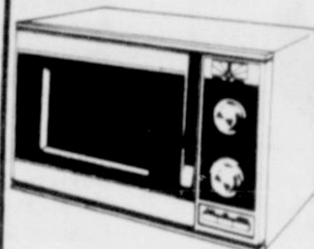

Includes Selector
Control to vary
cooking speed
Automatic defrost
setting
Cuts cooking time
up to 75%

ONE ONLY
\$390⁹⁵

BUY AT
THESE
LOW
PRICES,
THEN
BREAK A
BALLOON
AND GET
MORE \$\$\$
OFF!

KITCHEN AID

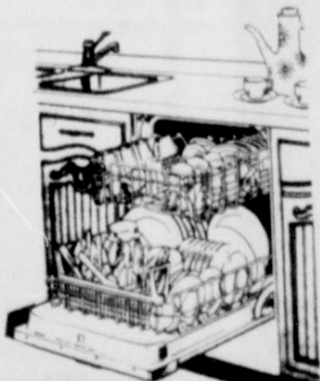

KITCHENAID Built-in
DISHWASHER
CHOICE OF COLORS

ONE ONLY \$299⁹⁵

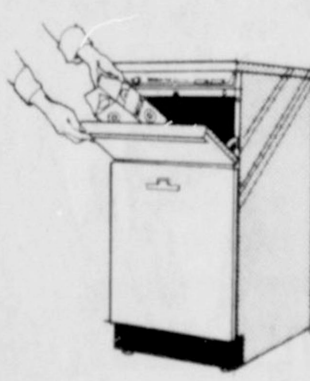

KitchenAid Trash
Compactor
Exclusive Litter Bin.
Use with or without bags.
It's really worth it.

\$325⁹⁵ GOLD ONLY

PHILCO
COLD GUARD
REFRIGERATOR

FEATURED VALUE

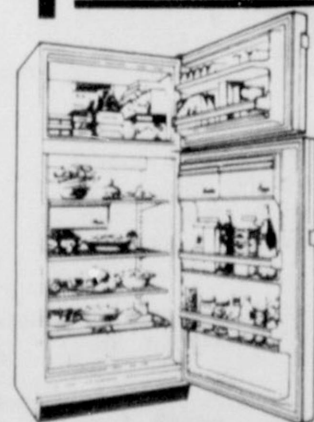

RD1E 7

16 cu. ft. capacity

Only \$399⁰⁰

GOLD ONLY



RT19B8 WHITE

NOW ONLY

\$523⁰⁰

Our entire stock
will be specially
tagged for this sale.

WILHELM
TV &
Appliance

521 MAIN FRIONA, TEXAS PHONE 247-3035

REVCO



FACTORY SPECIAL
9.9 cu. ft. CHEST FREEZER

Patented "Bonded-
freeze" to fast freeze
anywhere in chest—
Sliding basket.

\$269⁹⁵

Big family-size freezer
Upright or chest models

TAPPAN
with
Energy-Saving
Electric Ignition

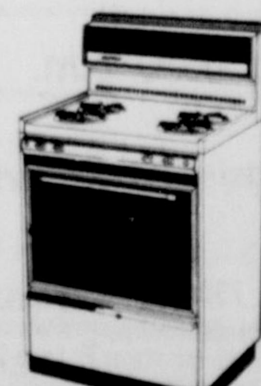

389⁹⁵

WHITE ONLY
Model 30-2656

The Making Of A State Champion...



GET SET...Tammie Smith of Lazbuddie, shown at right, in her set position just prior to the class B 880-yard dash at the state meet. At the far left in lane one is the class B defending champion, Janet Doyal of Lohn. Gloria Carter of Meridian is in lane two.



FIRST LAP...Just completing the first lap of the 880-yard dash for class B, Lazbuddie's Tammie Smith is beginning to move up on the outside. From right to left are Gloria Carter, Meridian, Debbie Bolk, Texline, Janet Doyal, Lohn, and Miss Smith.



WINNING SPRINT...Tammie Smith, left, is shown as she completed her finishing kick, to beat Debbie Bolk, right, by .4 second and take the state title in the 880-yard dash. Miss Smith, who had won the District 1-B title, finished second to Miss Bolk in the regional, but turned the tables at Austin.

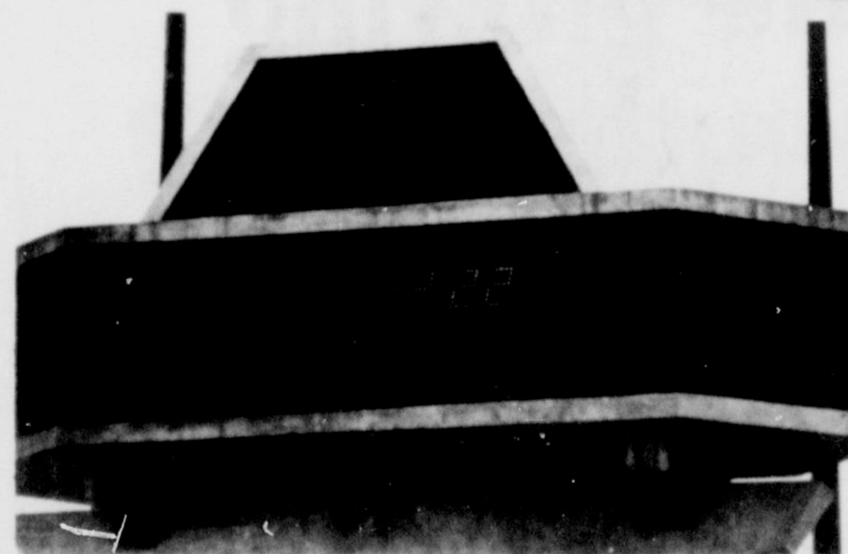

WINNING TIME...The ultra modern scoreboard at Austin's Memorial Stadium was an attraction of its own for participants and spectators at the state meet. Tammie Smith's winning time, an unusual 2:22.22, was captured by the Star's camera as it was flashed at the conclusion of the race.



CONGRATULATIONS.... Debbie Bolk of Texline was the first person to offer congratulations to Lazbuddie's Tammie Smith at the conclusion of the 880-yard dash at the state meet in Austin last weekend.

+++
880-Yard Run: 1. Tammie Smith, Lazbuddie, 2:22.22; 2. Debbie Poik, Texline, 2:22.6; 3. Temple Kallus, Holland, 2:25.3; 4. Gloria Carter, Meridian, 2:25.8; 5. Janet Doyal, Lohn, 2:26.7; 6. Lou Mewhinney, Holland, 2:27.8.

Lazbuddie Girl Wins State Title



HAPPY WINNER....Tammie Smith smiles for the Star's camera as she stood on the winner's stand and clutched her gold medal, symbolic of winning the state title in the 880-yard dash.

Unheralded and unsung, Tammie Smith of Lazbuddie was the lone gold medal winner from Parmer County at the track and field portion of the UIL girls state meet last weekend in Austin.

A junior this year at Lazbuddie High School, Tammie staged a strong finish in the class B 880-yard dash to nip region one champion Debbie Poik of Texline at the wire. Miss Smith's winning time was registered at 2:22.22.

"I wasn't tired at all. I was surprised to have that much left," Tammie said immediately after the race in an interview with the Friona Star representative.

"I didn't have any idea I'd win. I didn't know what any of the other regional times were. I just wanted to stay close to Debbie (the Texline runner who had edged her at the class B regionals)."

Tammie did a good job of staying with Miss Poik, and when the two rounded the final curve and headed down the final 100 yards, she suddenly decided that she could win the race, and reached down for a good finishing kick that left the Texline runner a surprised second.

A check of the records showed that Miss Smith, the daughter of Mr. and Mrs. Gene Smith of the Lazbuddie community, had the second best qualifying time of the eight state meet entries. Debbie Poik's time was the best, just barely ahead of Tammie's.

In addition to beating her Region I rival, the Lazbuddie lass also unseated Janet Doyal of Lohn, the 1976 state champion in the event, who placed fifth this time around.

Miss Doyal and Gloria Carter of Meridian helped set the pace during the first lap, with Miss Smith content to run about fourth, although there never was much distance between any of the runners.

At the beginning of the final lap, Miss Poik began to pick up the pace, and Tammie wisely followed her lead. The other two girls dropped back to third and fourth, and then in the final steps of the race, Tammie charged past the Texline girl for the medal.

The 880-yard dash was the second running event of the day on Saturday. Miss Smith thus had her day's work finished early (by 1:20 p.m.) and could relax and enjoy the rest of the day's festivities.

At the regional meet, Tammie had also entered the 220-yard dash, long jump and high jump, having placed second in those events at district. She also ran on the school's mile relay team, which was second in district, and was a member of Lazbuddie's district champion girls golf team.

This week, her cousin, Charleson Steinbock, will be an entry for LHS in the hurdles at the boys state meet.

The winning time was almost four seconds better than her previous best, 2:26 at the regional meet.

"I decided at the first of the year that I wanted to run the event in under 2:23," Tammie concluded following her triumph. She achieved everything she set out to do—and more.

LEGAL NOTICE

Notice Is Hereby Given That The Parmer County Commissioners Court Will Convene As A County Board Of Equalization On Monday, May 23, 1977, At 2:00 P.M. In The County Courtroom.

Any And All Persons Who Wish To Meet With The Board Of Equalization And Discuss Any Tax Matters Will Be Welcome.

Signed: James P. Fortenberry
County Judge
Parmer County, Texas 2tc

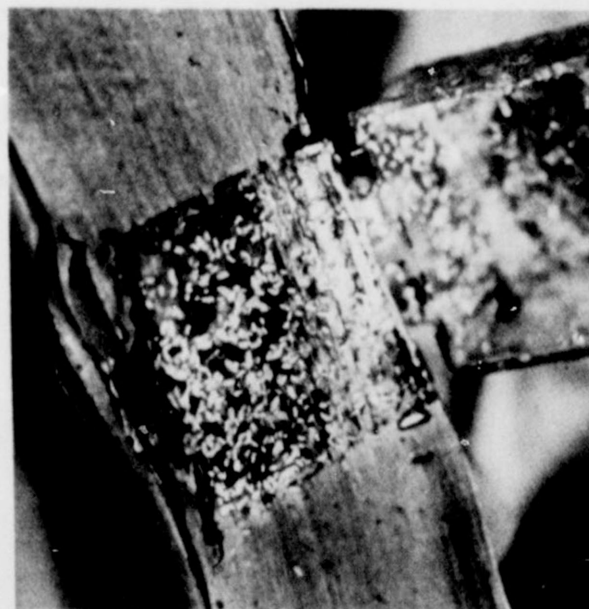

JON RESISTANCE — Greenbugs capped on a susceptible sorghum leaf suck the leaf's juices and inject deadly toxins, killing the formerly healthy tissue. Grain-producing capacity is cut dramatically.



GREENBUG RESISTANCE — Fewer greenbugs live on the leaves of NK hybrids with greenbug resistance. Greenbugs do not kill the tissue. The plants tolerate the presence of these aphids, but grain yields are seldom affected.

GET HIGHER PROFIT YIELDS WITH NORTHRUP KING GREENBUG RESISTANCE GRAIN SORGHUM

- ★ NK-2779... Medium Late Maturity, Semi-Compact Heads.
- ★ NK-2778... Medium Late Maturity, Strong Stalks, Roots
- ★ NK-2884... Full-Season Maturity, High Production Hybrid, Heat Tolerance.

★ WE STILL HAVE PLENTY OF CORN AND SUNFLOWER SEED AVAILABLE



- ★ DRYLAND MAIZE
- ★ HAY GRAZERS

HARRELL MAYS
PHONE 247-3477

Savings GALORE!

AT WILHELM
TV &
APPLIANCE

What a deal
WE'VE GOT FOR YOU!

BIG THREE DAY SALE

SAVE MONEY NOW!

Thursday, Friday, Saturday

May 19-20-21 Open Till 9 p.m. on Thurs.

Come In And
Register For A FREE

TAPPAN
Microwave Oven



Save Time,
Energy And
Money With
A Full Size

FREE
COFFEE & COKES

Come In And Burst One Of The Many Balloons
Located All Over Our Store. Each Balloon
Contains A Cash Discount On Merchandise
Purchased During Our Big Sale.

\$ OFF
Quasar TV
CLEARANCE

Quasar 12" Portable COLOR TV **\$100⁰⁰**
Off

100% Solid State "Service Miser" Chassis
Bright, Sharp Picture
Uses less energy than a 60 watt light bulb
Lightweight—weighs only 28 lbs.

NOW ONLY
\$268⁸⁸

Quasar 19" Color TV

100% Solid State "Service Miser" Chassis
Brilliant, Sharp Picture
Picture Control
Sharpness Control
Automatic Fine Tuning

Now only
\$368⁸⁸

Console Color TV

2 Only 23" Quasar Only **\$569⁹⁵**
1 Only 25" Quasar Only **\$599⁹⁵**
1 Only 25" Quasar Only **\$620⁵⁰**

TAPPAN
Microwave Oven

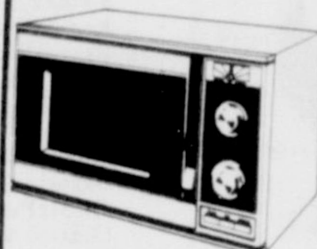

- Includes Selector Control to vary cooking speed
- Automatic defrost setting
- Cuts cooking time up to 75%

ONE ONLY
390⁹⁵

ALL PRICES CUT ON
FEDDERS
Room Air Conditioner

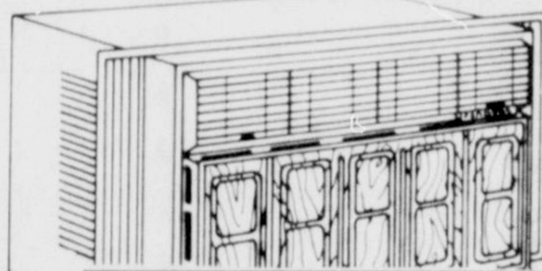

Our entire stock
will be specially
tagged for this sale.

KITCHEN AID

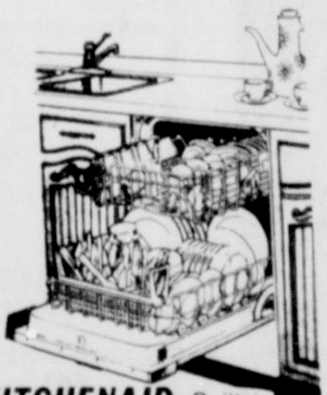

KITCHENAID Built-in
DISHWASHER
CHOICE OF COLORS

ONE ONLY **\$299⁹⁵**

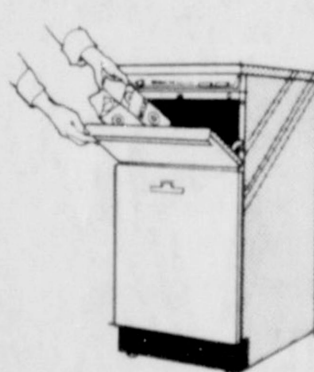

KitchenAid Trash
Compactor.
Exclusive Litter Bin.
Use with or without bags.
It's really worth it.

\$325⁹⁵ GOLD ONLY

SPEED QUEEN
Built better to last longer.

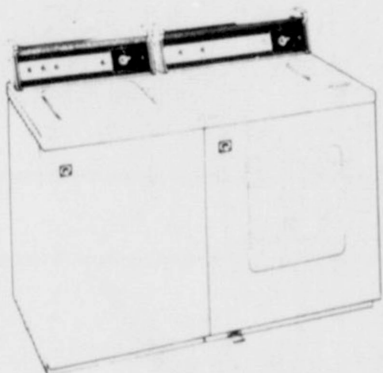

Model FA6011

SAVE
\$85⁰⁰

NOW ONLY
\$620⁰⁰

GREEN ONLY

PHILCO
COLD GUARD
REFRIGERATOR

FEATURED VALUE

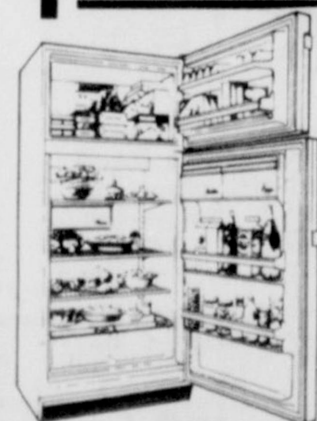

RD1E 7

16 cu. ft. capacity

Only \$399⁰⁰

GOLD ONLY



RT19BB **WHITE**

NOW ONLY

\$523⁰⁰

Our entire stock
will be specially
tagged for this sale.

WILHELM
TV &
Appliance

521 MAIN FRIONA, TEXAS PHONE 247-3035

REVCO



FACTORY SPECIAL
9.9 cu. ft. CHEST FREEZER

Patented "Bonded-Freeze" to fast freeze anywhere in chest-sliding basket.

\$269⁹⁵

Big family-size freezer
Upright or chest models

TAPPAN
with
Energy-Saving
Electric Ignition



389⁹⁵

WHITE ONLY
Model 30-2656

Babe Ruth Loop Kicks Off Here

The Friona Senior Babe Ruth League team was to open its season Friday at Muleshoe, and then were set to host their first home game on Sunday at 3 p.m. when the team is to meet Sudan in a game at the West Park.

"We have some of the greatest material I've ever seen," says Ron Cain, spokesman for the team. Cain said he felt that the Friona aggregation, which is made up of players from both Friona and Bovina, should compete for the league title in only their first year of competition.

The league is for boys 16-18 years of age.

Cain said that the starting lineup for the Muleshoe game was expected to look like this: pitcher—Edward Castillo; catcher—Ruben Salazar; first base—Leslie White; second base—Ronnie Cary; third base—Dan Cox; shortstop—Jesus Mata; left field—Jeff Whiteside; centerfield—Paul Ortiz and rightfield—Willie

Brailiff.

Gary Stone will serve as relief pitcher for the team. Jerry Martin will be a pinch hitter and is a catcher. Gerald Shelby, also a catcher, is expected to see a lot of action.

"We have a heck of a strong bench. We have some specialists who can come in and really help us, and not just be plugging a gap," Cain says.

Others on the team include infielders Eddie Brailiff, Ernest Mills and Steve Stevenson and outfielders Larry Ball, Boniface Beavers and David Merrill.

Sunday's starting pitcher will be either Castillo or Dan Cox. The games will be seven-inning contests. The Littlefield game, which was postponed from last Sunday due to school activities at Littlefield, may be rescheduled for Bovina at a later date, Cain said. All of the team's regular Sunday games will be played in Friona, it was noted.

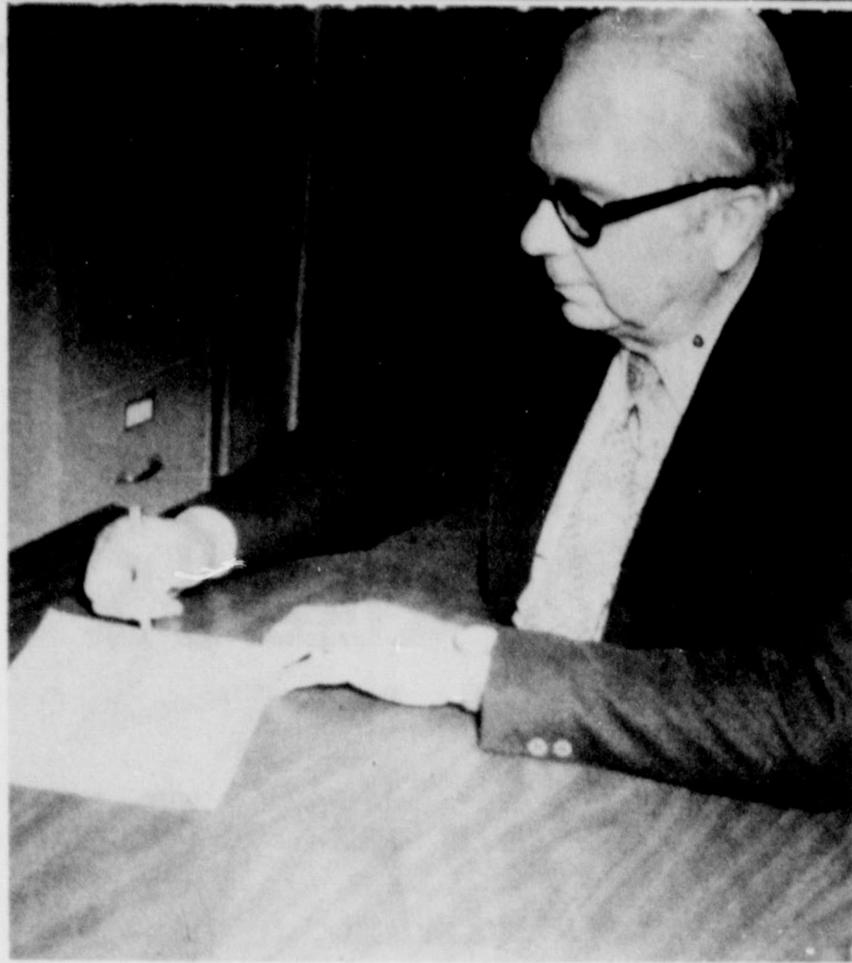

PROCLAMATION...Parmer County Judge Paul Fortenberry is shown signing a proclamation declaring the week of May 15-22 as Soll Stewardship Week in Parmer County.

Squaws Place 5th In Fast Company

Friona High School's Squaws, running in the elite field containing the state's eight top 880-yard relay teams, placed fifth in the state meet last Friday night in Austin, although running their best time of the year, 1:44.1, which also was a new school record.

The foursome of Cindy Cleveland, Paige Osborn, Jatón Widner and Janice Peak had the farthest outside lane assignment—lane eight, the least desirable lane from a competitive standpoint.

With the big lead due the staggered start, Cindy Cleveland held first place for her portion of the race, although North Lamar, which finished second in the event, almost made up the stagger on the first lap. Paige Osborn held the first place

spot for her lap, but a little bad timing on the second exchange cost Friona the lead, and perhaps a step or so. Janice Peak closed fast, but was unable to make up the lost ground.

District 3-AA mate Littlefield, which had beaten the Squaws in the regional meet, placed sixth behind Friona in 1:45.1.

It was the final performance for the Squaws by seniors Jatón Widner and Janice Peak. It was the fourth appearance in a state meet for Miss Widner, all four on relay teams.

During the course of the two-day meet, 43 conference records were shattered, a number of state marks broken, and ten national records were broken or tied by the select group of girl athletes.

Little League Begins Play

Little League season for 1977 kicks off in Friona Monday, with 15 local teams plus a Bovina team competing in four leagues.

This is the same number of teams as competed in the 1976 program.

There are once again five teams in the Minor League, three in the T-Ball League, four Major League outfits and three Friona teams plus Sherley Grain of Bovina in the four-team Senior League. In addition, there is a Senior Babe Ruth

League team which was to kick off its season schedule this weekend.

Once again this year, the team will play a full schedule for its first week, May 16-20, and then will take a week off during the week of graduation and end of school activities.

The schedule is designed so that it will be completed by Friday, July 1. It will mark the second year in a row that the Little League program will be terminated by July 4.

Shower Honors Lisa Taylor

A bridal shower honoring Lisa Taylor, bride-elect of Kenny Miller of Perryton was held in the home of Mrs. Curtis Murphree Saturday, May 7.

Other hostesses included Mrs. T.A. Kelley, Mrs. Joe Talley, Mrs. Benny Pryor, Mrs. Ralph Taylor, Mrs. Bill Stephens, Mrs. W.L. Cleveland, Mrs. Dale Westbrook, Mrs. Delton Lewellen, Mrs. Charles Sanders.

Also, Mrs. W.D. Buske, Mrs. W.S. Ingram, Mrs. Bruce Parr, Mrs. Jim

Bailey, Mrs. David Smith, Mrs. Jim Johnston, Mrs. Buddy Wiseman, Mrs. Doyce Barnett and Mrs. Leta Tannahill.

Out-of-town guests signing the guest register were Mrs. R.H. McFarland of Tucumcari, N.M., Mrs. W.D. Dickenson of Olton, Chesna Dickenson and Terry Steinman of Abilene, Vickie Pryor of Lubbock, Carolyn Wiseman of Plainview, Mrs. Ronnie Wood, Dana and Mark and Mrs. Miller, all from Perryton.

Little Dribblers Winners Listed

The Sweet Tarts won their league title, and the Jelly Beans were the champs of their division in the girls' Little Dribblers tournament completed this week in Friona.

The Sweet Tarts beat the Charms, 24-16 in their first tournament game, and then topped the Lollipops, 24-4 in the championship game.

Amanda Perez was the high point girl for the winners, scoring 18 points in their win over the Charms, and 10 in the title game.

The Peanut Patties edged the Charms, 24-20 for third place, as Devera Rhodes and Wendy Tatum scored eight points each. Stephanie Miller led the Charms with six points, the same number that Rosa

Pena got.

In the other league, the Jelly Beans edged the Cracker Jacks, 24-21 in the first round game. Judy McLellan scored 20 points for the Jelly Beans, while Lisa Guerra accounted for 10 points for the Cracker Jacks.

In the title game, Miss McLellan scored 12 points, while Diane Johnston scored ten for the Pop Tarts.

The Cracker Jacks downed the Sugar Babies, 12-6 for third place. Alma Ramirez scored four points, the same number as Kristi Britting got for the Sugar Babies.

The action wound up the girls' Little Dribblers action on the local level for this year.

Pick up a smooth talker!

Our sleek and colorful Styleline® phone (in smashing designer shades) is a sensational accent piece for any contemporary environment. And it's just one of many unique and beautiful phones you can order now. Call our business office and ask about our low monthly rates.



We have an eye for your ears

GTB GENERAL TELEPHONE

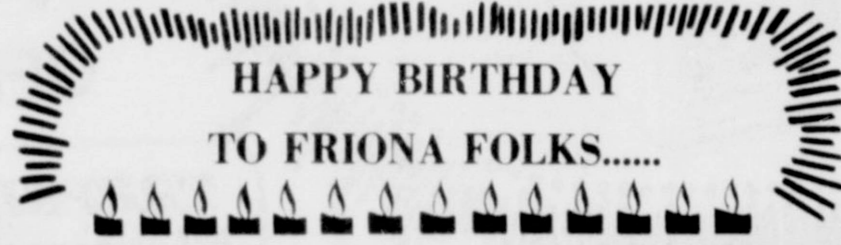

HAPPY BIRTHDAY TO FRIONA FOLKS.....

- WEEK OF MAY 15-MAY 21
- The following local residents have birthdays coming up next week:
- Ronnie Reed, May 15
 - Denny Young, May 15
 - Ethel Bengier, May 16
 - Jay Hight, May 17
 - Shannon Taylor, May 17
 - Mary Bavousett, May 17
 - Beverly Gwen Drake, May 17
 - Jill McFarland, May 17
 - Charles Rector, May 17
 - Malinda Schlenker, May 18
 - Jimi Stephens, May 18
 - Carol Ellis, May 19
 - Ramey Beene, May 19
 - Pat Grissom, May 19
 - Gay Welch Bingham, May 20
 - Phillip Floyd Schueler, May 20
 - Faye Smith, May 21
 - Mark Zachary, May 21
 - Christy Lundy, May 21

If you or someone in your family has a birthday coming up soon, call the Friona Star at 247-2211 by Wednesday of the previous week and let them know about it.

FRIONA DIVE-IN SWIMMING POOL

1601 West Fifth Street

OPEN MAY 15 TO AUG. 15

HOURS: 1:00 To 6:00 p.m.



FOR ADDITIONAL INFORMATION CALL CITY HALL...

EVENINGS For Pre-Scheduled Private Parties 247-2761

ADMISSION

Children 1-12 75c
Adults (Over 12) . . . \$1.00

SEASON TICKETS

Children \$18.50
Adults 25.00
Family 40.00

SWIMMING CLASSES
Enroll Sat., June 5
ALL LEVELS
8 a.m. TO 12 NOON



THE DIETZ BROTHERS

DON WALLACE - PIANO

God has given different gifts to different people and He chose to give two strong beautiful voices to twins, the Dietz Brothers. The music of these men flows from a deep commitment to Jesus Christ as Saviour and Lord. They enjoy singing as much as they enjoy the Christian life and their audiences thrill to the exciting program they present.

As full-time music evangelists, they compel their audiences to examine the claims and promises of Jesus Christ and the new dimension of living which He makes possible. They can entertain, inspire, and challenge their audiences as their music and their lives lift up the Christ who can abundantly change your life.

MAY 15, 1977

11 A.M. Worship Service
6 P.M. Concert

CALVARY BAPTIST CHURCH

Try the money grower's saving salad



Mixed greens are good for you. Especially '10's, '20's and '50's.

The Money Growers Association serves up a tempting treat. Lots of lettuce, cabbage and spinach that pay you a healthy interest, compounded daily. Toss in a few bucks and see how fat we can make 'em. Money! It's always in season at The Money Growers Association. May we serve you?

THE MONEY GROWERS ASSOCIATION

5 1/4% - 6 1/2% - 7 3/4%

FRIONA REPRESENTATIVE
GATLIN LAND CO.

hi-plains savings & loan

HEREFORD & DIMMITT

"We look to your future with interest."

Directors Attend Tour Of Facilities

A tour designed to point out the scope and magnitude of responsibility of Deaf Smith Electric Cooperative was attended recently by the Cooperative's Board of Directors.

The all day tour, covering over 240 miles and three of the four counties served by the electric cooperative, included stops at the REC's 16 electric substations. The substations provide the power requirements of the rural areas of Oldham, Parmer, Castro and Deaf Smith Counties. These stations have a combined capacity exceeding 87,000 KVA or 117,000 horsepower.

The tour's first stop was in the Ford community where a proposed substation is to be erected this year in order to provide the ever increasing electrical needs of Oldham and northwest Deaf Smith Counties. In addition, the other five substations in Deaf Smith County were viewed.

Next on the agenda were the four substations serving the Parmer County area. These stations are located near the Rhea, Oklahoma Lane and Farwell communities, plus

a substation serving the general area surrounding Friona. The aggregate capacity of these stations exceed 36,000 horsepower.

The six substations in Castro County have the capability of providing the needs of over 36,000 horsepower. The newest station is located in the growing Nazareth area. Three stations are required to serve the needs of the northern half of the county, plus one located in the vicinity of the Flagg Community.

The tour, attended by all seven Directors, was very timely and informative in better acquainting the Cooperative's Board with the ever incurring responsibility and size of the locally owned electric cooperative.

Those attending the tour were Raymond Annen, Nazareth; Noel Gollehon, Dimmitt; Clark Andrews, Frio Community; Jerry Roberts, new Director from the Simms Community; Eldred Brown, Bootleg; A.W. Anthony, Jr. and Sloan Osborn of the Friona area. Also in attendance were Loran Nixon, Operation Manager and James Hull, General Manager of Deaf Smith REC.

Business News

News About Business And Industry In The Friona Area.



TAKING A PAUSE...During the recent Directors' Tour of Deaf Smith Electric Cooperative, from left to right Dub Anthony, Friona; Eldred Brown, Bootleg; Noel Gollehon, Dimmitt; Raymond Annen, Nazareth; and Sloan Osborn, Friona. In all, the tour included over 240 miles and visits to 16 electrical substations in three of the four counties served by the REC.

Wilhelms Complete First Year Locally

A gala discount sale has been announced for next Thursday, Friday and Saturday, May 19-21, at Wilhelm TV and Appliance, 621 Main in Friona.

Joe and Bonnie Wilhelm, who observed their first anniversary in business in Friona last month, are staging a tremendous clearance sale, with virtually everything in the store marked down.

In addition to the special prices, customers are asked to register whenever they come into the store for a free Tappan microwave oven to be given away to some lucky customer.

As a special promotion, there will be balloons throughout the store, each one containing cards with special discount information. Customers will be allowed to burst a balloon, and then will be eligible for the special discount contained inside their balloon.

The discounts will vary all the way from 50 cents to \$25.00 on certain items. They will receive these discounts in addition to the advertised discounts. (See the company's advertisement on page 9 of this issue).

Wilhelm's will be open on

Thursday evening until 9 p.m. for the first day of their special promotion. They will be serving free coffee and soft drinks during the sale.

The Wilhelms purchased the local business in 1976 from Jimmy Nobles. They carry a full line of appliances, including Quasar televisions, KitchenAid dishwashers, Tappan, Speed Queen Laundry Equipment, Philco Cold Guard refrigerators, Revco freezers.

"Offering the largest service department in all major brands," is the motto at Wilhelm TV & Appliance. Wilhelm has 19 years of experience in the field of servicing TV and electronics. They invite you in during their May spectacular appliance sale.

"We sure appreciate the support and concern of the people of the Friona area during our first year in business. They have been very loyal in trading with us, and this has enabled us to grow. The folks here are the finest you'll find anywhere," Wilhelm says.

"Money makes a man laugh." John Seiden

LITTLE LEAGUE Schedule

West Park

Senior And T-Ball Leagues



MONDAY TUESDAY THURSDAY FRIDAY

MAY 16	MAY 17	MAY 19	MAY 20
Cattle Town vs Bengier	Tasty Cream vs Piggly Wiggly Sherley Grain vs Pioneer	Benger vs Cattle Town	Credit Union vs Tasty Cream Pioneer vs Sherley Grain
MAY 30	MAY 31	JUNE 2	JUNE 3
Credit Union vs Piggly Wiggly Sherley Grain vs Cattle Town	Pioneer vs Bengier Olton vs Friona (Babe Ruth)	Cattle Town vs Sherley Grain	Piggly Wiggly vs Tasty Cream Benger vs Pioneer
JUNE 6	JUNE 7	JUNE 9	JUNE 10
Pioneer vs Cattle Town	Tasty Cream vs Credit Union Sherley Grain vs Bengier	Cattle Town vs Pioneer	Credit Union vs Piggly Wiggly Benger vs Sherley Grain
JUNE 13	JUNE 14	JUNE 16	JUNE 17
Cattle Town vs Bengier	Tasty Cream vs Piggly Wiggly Sherley Grain vs Pioneer	Benger vs Cattle Town	Credit Union vs Piggly Wiggly Pioneer vs Sherley Grain
JUNE 20	JUNE 21	JUNE 23	JUNE 24
Pioneer vs Bengier	Credit Union vs Tasty Cream Sherley Grain vs Cattle Town	Benger vs Pioneer	Piggly Wiggly vs Tasty Cream Cattle Town vs Sherley Grain
JUNE 27	JUNE 28	JUNE 30	JULY 1
Sherley Grain vs Bengier	Credit Union vs Tasty Cream Pioneer vs Cattle Town	Benger vs Sherley Grain	Credit Union vs Piggly Wiggly Cattle Town vs Pioneer

First Game Starts At 6:00 P.M.
Second Game Starts At 8:00 P.M.

First Team In Pairings Is Home Team.
Make-up Games Played On Saturday.

FRIONA CABLEVISION

FRIONA LIONS CLUB

LITTLE LEAGUE Schedule

East Park

Major And Minor Leagues



MONDAY MAY 16	TUESDAY MAY 17	THURSDAY MAY 19	FRIDAY MAY 20	SATURDAY MAY 21
Hi-Pro vs BJ Bees Friona Star vs Friona State Bank	Ethridge-Spring vs Parmer Co. Implement Reeve Chevrolet vs Friona Feed Yard	Ag-Chem vs Hi-Pro Friona State Bank vs Friona Star	BJ Bees vs Ethridge-Spring Friona Feed Yard vs Reeve Chevrolet	Parmer County Imp. vs Ag-Chem
MONDAY MAY 30	TUESDAY MAY 31	THURSDAY JUNE 2	FRIDAY JUNE 3	
Ag-Chem vs BJ Bees Friona Star vs Reeve Chevrolet	Hi-Pro vs Parmer County Imp. Friona State Bank vs Friona Feed Yard	Ag-Chem vs Ethridge-Spring Reeve Chevrolet vs Friona Star	Parmer County Imp. vs BJ Bees Friona Feed Yard vs Friona State Bank	
JUNE 6	JUNE 7	JUNE 9	JUNE 10	
Hi-Pro vs Ethridge-Spring Friona State Bank vs Reeve Chevrolet	Ag-Chem vs Parmer County Imp. Friona Star vs Friona Feed Yard	BJ Bees vs Hi-Pro Reeve Chevrolet vs Friona State Bank	Parmer County Imp. vs Ethridge-Spring Friona Feed Yard vs Friona Star	
JUNE 13	JUNE 14	JUNE 16	JUNE 17	
Hi-Pro vs Ag-Chem Reeve Chevrolet vs Friona Feed Yard	BJ Bees vs Ethridge-Spring Friona Star vs Friona State Bank	Parmer County Imp. vs Hi-Pro Friona Feed Yard vs Reeve Chevrolet	BJ Bees vs Ag-Chem Friona State Bank vs Friona Star	
JUNE 20	JUNE 21	JUNE 23	JUNE 24	
Ethridge-Spring vs Ag-Chem Friona State Bank vs Friona Feed Yard	BJ Bees vs Parmer County Imp. Friona Star vs Reeve Chevrolet	Ethridge-Spring vs Hi-Pro Friona Feed Yard vs Friona State Bank	Parmer County Imp. vs Ag-Chem Reeve Chevrolet vs Friona Star	
JUNE 27	JUNE 28	JUNE 30	JULY 1	
Hi-Pro vs BJ Bees Friona Star vs Friona Feed Yard	Ethridge-Spring vs Parmer Co. Imp. Friona State Bank vs Reeve Chevrolet	Ag-Chem vs Hi-Pro Friona Feed Yard vs Friona Star	Ethridge-Spring vs BJ Bees Reeve Chevrolet vs Friona State Bank	

First Game Starts At 6:00 P.M.
Second Game Starts At 8:00 P.M.

First Team In Pairings Is Home Team.
Make-up Games Played On Saturday.

Presented Through the Courtesy of:
REEVE CHEVROLET - OLDS.



The Dietz Brothers, music evangelist duet from Borger, will present a singing program at the Calvary Baptist Church Sunday at 11 a.m. and again in concert tonight at 6 p.m.

The twins, Phil and Andy, grew up in Borger, and while in high school they were members of the Texas All-State Choir in 1970. They attended WTSU and travelled with a college pop music group on a special U.S.O. tour of the Caribbean.

Since graduation they have sung with the Royalheirs, a gospel singing group from Amarillo.

Since the first of this year they have been headquartered in Canyon. They are accompanied by Don Wallace, a native of Phoenix, Arizona. He has won four soloist awards from jazz festivals during his high school career, and with the Dietz Brothers, he is accompanying their duet and occasionally joins them vocally.

Future Teachers Install Officers

Culminating the year's activities, members of the Ethel Bengel chapter of Future Teachers of America met at the Parmer House Restaurant on the evening of April 28 for dinner and to honor outgoing officers.

Outgoing officers were Melodi Dixon, president; Debbie Parker, vice president; Faith Mays, secretary-treasurer; Veronica Lafuente, historian; and Sharla Bengel, reporter.

New officers are: Debbie Parker, president; Jerri Walters, vice president; Cheriee Parker, secretary-treasurer; Varla Welch, historian and Veronica Lafuente, reporter.

The ceremonies were conducted by the chapter sponsors, Thelma Coffey and Carmaleet Truitt.

Also on the program was a resume given by Debbie Parker about the FTA State Convention held in San Antonio in February. Girls attending the convention were Debbie Parker, Connie Merrell, Faith Mays,

Veronica Lafuente, Ronnie Hudson, Shannon Taylor and Melodi Dixon.

A report of the year's activities was given by Thelma Coffey as she honored the outgoing officers. Plaques were presented to Bryan Johnston and Sharla Bengel for Mr. and Miss FTA. A plaque was also awarded to Melodi Dixon, outgoing president.

Appreciation gifts were presented to the two sponsors, Mrs. Carmaleet Truitt and Mrs. Thelma Coffey.

FTA members attending were: Janice Peak, David Whitaker, Shannon Taylor, Karen Young, Manuel Rodriguez, Melodi Dixon, Sharla Bengel, Veronica Lafuente, Faith Mays, Debbie Parker, Rolanda Hudson.

Also, Connie Merrell, Betty Rando, Jerri Walter, Kim Frye, M'Linda London, Debbie Menefee, Renae Monroe, Julie Owen, Cheriee Parker, Varla Welch, Vickie Smiley, Laura Ellis, Priscilla Pruitt, Mrs. Coffey and Mrs. Truitt.

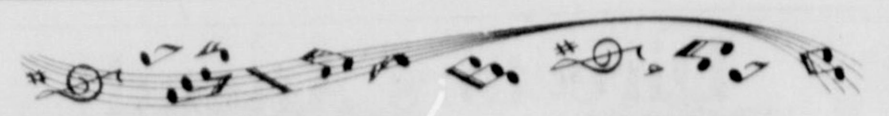

CLINT MEARS



BRYAN JOHNSTON

Three Frionans To Present Piano Concert

Mrs. Eva Miller will present Clint Mears, son of Mr. and Mrs. Sam Mears, in a piano concert Sunday at the First Baptist Church. The concert will begin at 2:30 p.m.

Mike Murphy and Bryan Johnston, as guest performers, will be using several original selections.

Clint has been participating in Piano Guild Auditions for eight years, and the National Federation for ten years.

The public is invited to attend.



MIKE MURPHY

Baxter To Receive Degree From OST

Blayne Dee Baxter, Friona, is one of 355 Oklahoma State Tech graduates scheduled to receive a diploma Friday, May 13.

They are members of the 86th class to graduate from Tech, the largest residential, technical college in the nation. Tech also is the residential, technical branch of Oklahoma State University.

Wayne W. Miller, a vice president of Oklahoma State University and director of Oklahoma State Tech, will present diplomas at the 7:30 p.m. ceremony held in Covelle Hall on campus.

Dr. Carroll V. Galbreath, assistant regional commissioner for post-secondary education for the U.S. Office of Education in Dallas, will deliver the commencement address.

An honors and awards ceremony is scheduled the same day at 2 p.m. in Covelle Hall. Students receiving special academic and leadership awards and those who earned a position on either the Director's or Registrar's Honor Rolls, will be honored.

Each instructional department will host an open house for graduates, their families and friends from 3-5 p.m. and following commencement.

Baxter will receive a diploma in diesel and heavy equipment me-

chanics.

He is the son of Mr. and Mrs. Billy Dean Baxter.

SAVE NOW FOR YOUR RAINY DAY!



Expect The Unexpected And Be Ready For It.

Tri-County

SAVINGS AND LOAN ASSOCIATION

Offices in MULESHOE · FARWELL · FRIONA · LITTLEFIELD

HALF PRICE SUNDAE SALE



Twice as nice... at half the price!

Your choice of any scrumptious Dairy Queen Sundae, any available size or flavor, with luscious whipped topping, crunchy pecans, and crowned with half a juicy cherry!

Tuesday thru Sunday
May 17-22 only

Dairy Queen

At participating stores.

AUCTION

Thursday, May 19 1977

Time: 1:00 P.M. MDST

Located: From Texico NM, 23 1/2 miles North on highway 108. Then 1 1/2 miles north on caliche Rd. then 3/4 East

From: Bellview, NM 3 Miles East 5 miles south then 3/4 East

From: Friona, TX. 9 miles west on highway 1731 Then 3 miles west, 5 miles north, 4 miles west on highway 2013.

Then 1 mile north 1 mile west 1/2 mile north on dirt road.

OWNER

Howard Duncan

I have sold my farm and will offer at public auction, the following list of equipment

TRACTORS

- 1 1972 1150 Massey Ferguson Diesel SN: 9B25178 with Factory Cab, A.C., Dual Hyd., Weighted & 18.4X38 Duals 1882 Hrs.
- 1 1967 1100 Massey Ferguson Diesel SN: 9B10536 with Dual Hyd., Cab, Power Adjusting Whels, 18.4X34 Tires. (Block is Busted)
- 1 1974 790 David Brown Diesel SN: 858289 with P.S., 16.9/14-30 Tires and 700 Job-Master Front End Loader
- 1 2310 Case Riding Garden Tractor with mower and Rotary Tiller attachments

CORN HEADER-COMBINE TRUCKS-GRAIN CART

- 1 1974 7700 John Deere Turbo. Combine Diesel with Factory Cab, A.C., and 24' Header (Good)
- 1 John Deere 6 Row Corn Header (Good)
- 1 1964 Chevrolet Tilt-Cab Truck with 327 Motor, Hoist, and 16' All Metal Bed. Transmission is 4 speed with 2 speed axle
- 1 1956 6100 Chevrolet Truck with 14' Bed
- 1 Big 12 Grain Cart with extensions (Good)
- FARM EQUIPMENT**
- 1 Krause 18' Offset Disc
- 2 Lilliston 6 Row Rolling Cultivators (Good)
- 2 John Deere 707 Shredders
- 1 IHC 16"x10" Grain Drill with Press Wheels
- 1 Hamby 7 Row Lister and Hyd. Markers
- 1 6 Row Lister with Hyd. Markers & Double Gauge Wheels
- 1 Big 12 Rod Weeder on 6 Row

- 4"x4" Double Tool Bar
- 1 14' Clodbuster
- 1 Eversman V-Ditcher (Cylinder Type)
- 1 30' R.R. Iron
- 1 20' R.R. Iron
- 1 Clark 9 Row Spray Rig with 400 Gal. Fiberglass Tank and Ace PTO Drive Pump on 2 wheels (Good)
- 1 Krause 15' Oneway
- 1 5 Row Double Tool Bar Rig with Sweeps
- 1 Ford 3"x16" Roll Over Breaking Plow
- 1 Allis Chalmers 3 Point 8' Blade
- 1 6 Row Crustbuster
- 1 21' 7 Shank Stubble Mulch Plow
- 1 Moliene 5 Row Lister
- 1 Moliene 4 Row Lister Planter
- 1 John Deere 4 Section Harrow
- 2 John Deere 3 Bottom Breaking Plows (Drag Type)
- 1 7"x40" Bed Shaper Attachment
- 1 Burch 4 Row 3 Point Rotary Hoe
- 1 Big 12 4 Row Rod Weeder
- 1 3 Point Post Hole Digger (Good)
- 1 Allis Chalmers 12' Offset Disc
- 1 6 Row Planter IHC Double Tool Bar (All New Disc)

IRRIGATION RELATED EQUIPMENT

- 3 Chevrolet 292 6 Cylinder Motors (All Run)
- 1 Ford 300 6 Cylinder (Runs)
- 2 Chrysler 413 Motors (Need Rebuilt)
- 1 8" Harvest King Pump, 320' Set-
- 1 8" Lane Pump, 330' Setting with 2B Amarillo Gear Head (Complete)
- 1 8" Harvest King Pump, 320' Setting with 2B Amarillo Gear Head (Complete)

- 38 Joints 8"x30" Flowline
- Joints 7"x20" Irrigation Pipe with 40" Spaced 2 1/2" Outlets
- 1 Lot 12"x17" New Style Hydrants
- 1 Lot Ls, Ts, and Caps
- 1 Lot 1 1/2", 2", and 3" Irrigation Tubes
- 1 Lot Tarps
- 1 20' Joint 5" Column Pipe
- 1 Lot 8" Column Pipe
- 1 Lot 8" & 5" Cooling Jackets
- LIVESTOCK EQUIPMENT**
- 1 Lot Wooden Cattle Panels
- 1 Lot 4" Treated Post
- 1 Richie Heated Cattle Watering Trough
- 1 Lot Metal Cattle Panels (different Lengths)
- 1 Cattle Squeeze Chute
- 2 3 Barrel Hay Feeders
- 2 8' Stock Watering Tanks
- MISCELLANEOUS**
- 1 Sun-Combine Wind Row attachment
- 1 1000 Gal. L.P. Tank 250 lb. Working Pressure
- 1 Lot 8"x8"x16" Cinder Blocks
- 1 6 Row Set of Fenders for Lilliston Rolling Cultivators
- 1 4 Row Set of Hestons
- 1 30 Gal. Saddle Tank for Trucks
- 1 Lot Hyd. Cylinders
- 1 4"x15" Grain Auger with 3/4 H.P. electric motor
- 1 Lot Barrels
- 1 150 Gal. Fuel Tank
- 1 Lot Drags
- 1 Lot Scrap Iron

Many Other Items Too Numerous To Mention

PRO AUCTION SERVICE

AUCTIONEERS

LARRY POTTS
Friona, Texas
(806) 295-6633

JESS SHIRLEY
Friona, Texas
(806) 295-3590

CLERK

LELAND GUSTIN
Friona, Texas
(806) 247-2146

Bands Participate In Friona Band Festival



BAND AWARDS.... Stanley Ellis, left, and Joey Howard won two of three awards given to soloists at the Friona Band Festival last week.

Ellis won the Outstanding Percussion Soloist Award and Howard won the Outstanding Brass Section Award. (Photo by Leon Watson)

Sixteen area elementary and junior high bands participated in the Friona Band Festival last week with Friona's eighth grade band being named outstanding band.

Friona sixth, seventh and eighth grade bands made first division ratings in concert and sight reading and, Friona soloist Stanley Ellis and Joey Howard won two of three awards given. Ellis, seventh grader, won the Outstanding Percussion Soloist Award and Howard, sixth grader, won Outstanding Brass Soloist Award.

Other bands making first division in both concert and sight reading were Vega, sixth and seventh grades, Farwell sixth grade, and Plainview seventh grade third period.

Bands making first division in concert only were Kress fifth and sixth grades, Sudan seventh grade, Plainview seventh grade first period, Idalou seventh and eighth grade and Sudan sixth grade.

Making a first division in sight reading only were Farwell fifth grade, and Texico sixth and seventh grades.

Those making second division in concert and sight reading were Hale Center's fifth grade and Lazbuddie.

Members of the Friona band are:

1ST DIVISION ENSEMBLE
Flute Trio--Kim Eustace, Christie Wiseman and Tawnya Hand; Penni Weatherly, Cari Hand and Shawn Osborn.

Brass Ensemble--Jay Norsworthy, Francis Guerra, Tony Lafuente, Sunny Horton, Trent Johnson,

Christy Chesher, Winfield Davenport, Greg O'Brian, Mitch Massey and Joe Reeve.

Flute Quartet--Kipi Fleming, Diana Wright, Dana Smith and Allison McMillan.

Sax Quartet--Jim Mabry, Robert Osborn, Mark Osborn and Theresa Bermea.

Twirling Trio--Cindy Alexander, Janette Reed and Kipi Fleming.

Twirling Duet--Brenda Seright and Gwen Maurer.

1ST DIVISION SOLO
Eighth Grade--Terri Lloyd, Mary Rodriguez, Cindy Alexander, Sydney Tongate, Kipi Fleming, Dana Smith, Janette Reed, Davvy Howard and Mark Zachary.

Seventh Grade--Joe Reeve, Christi Bengé, Winfield Davenport, Francis Guerra, Jay Norsworthy, Stanley Ellis, Bonny Lunday, Jim Mabry,

Penni Weatherly, Sunny Horton and Gwen Maurer.

Sixth Grade--David Hough, Kay Gaines, Donovan Salas, Patti Hinton, David Davila, Stanley Miller, Andy Alexander, Richard Malouf, Cara Brockman, Sandra Leal, Sherri Dodson, Cindy Drake, Judy McLean, Shelly White, Bobby Armstrong, Brian Edelman, Carol Bennett and Joey Howard.

Fifth Grade--Faith Wright, Doug Carthel, Stephen Newell, Brandon Thompson, Danny Auburg, Paul Melton, Matthew Loftis, Tonya McPherson, Kim Carthel, Valencia Koelzer, Jessica Maurer, Kristi Britting, Karen Lloyd, Diane Johnston, Johnny McLellan and Kevin Brogden.

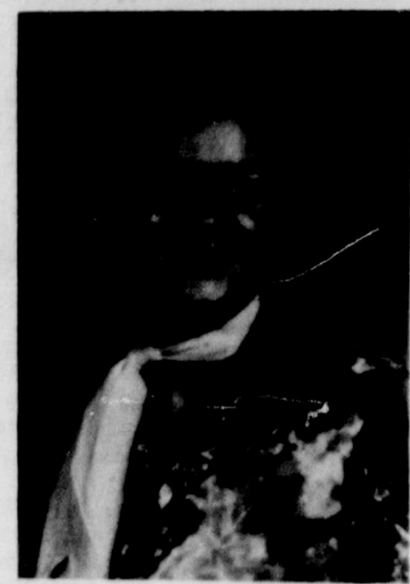

KAY COCHRAN, daughter of Mr. and Mrs. W.A. Cochran, is graduating from West Texas State University with a Bachelor of Business Administration degree in marketing. She is a 1974 graduate of Friona High School. While at WTSU she was a member of Phi Gamma Nu National Business Sorority Marketing Club.

Buttons & Bows Host Square Dance Locally

Friona Buttons and Bows Square Dance Club danced April 30 to guest caller, Johnny Culpepper of Roswell, New Mexico.

Refreshments of homemade ice cream and cookies along with Cokes and coffee were served to guests by hostesses of the Buttons and Bows

group.

Out-of-town guests were Arthur and Florence Robinson of Hereford and Evelyn and Johnny Culpepper of Circle Squares of Roswell.

The Circle Squares of Roswell dance every Friday at 8 p.m. at the Square Dance Barn at 307 East 19th in Roswell.

There will be a special dance September 29, 30 and October 1 at Roswell Fairground. There will be no fee charged at the dance.

++ ++ ++
The Friona Buttons and Bows Square Dance Club danced May 7 to the calling of Ed Gunnels of Clovis.

Out-of-town visitors from Hereford were: Dale and Rose Wright, Jerry and Karen Askew, Earl and Nadine Lance, Carlyle and Dorothy Sargent, Mary and Art Story and Nan and Bob Gaultuax. The Merry Mixers Club of Hereford dance on the first and third Fridays at the Community Center on Park Avenue to the calling of Sid Perkins.

Visiting from Clovis were: Walt and Winn, Art Cole and Maureen Hill. Clovis Swinging Wings dance every Friday night at Ranchvale School building which is six miles north of Cannon Air Force Base on Ranchvale Road. Their caller is Leroy Coffey.

Friona Buttons and Bows served Cokes and coffee to members of visiting clubs.

Club Hosts

Kidnap

Breakfast

A kidnap meeting was held by the Black Study Club on May 5 at the home of Mrs. Dick Rocky.

Mrs. Roscoe Ivie, member of the club, explained that Lois Weatherly, Tommy Taylor, and Mrs. Harry Lookingbill were in charge of picking up, or kidnapping, the members and taking them to the meeting place.

The ladies enjoyed a style show and refreshments of sweet rolls, coffee cake and coffee.

Members present were Mrs. T.J. Presley, Ethel Benger, Mrs. Bill Carthel, Fern Barnett, Emma Elmore, Mrs. Cliff Allmon, Mrs. Glynn Hamilton, Helen Fangman and Mrs. Ivie.

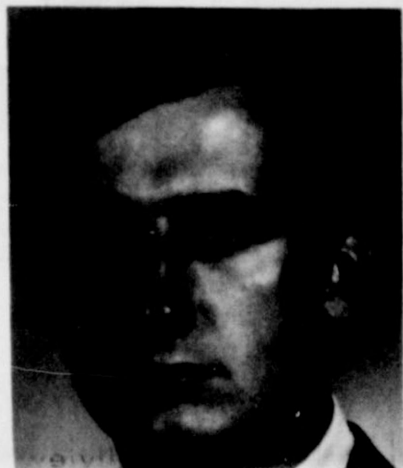

MARON FINLEY graduated from Texas Tech University, Lubbock, on May 14 with a bachelor of science degree in agricultural education. Finley, a 1972 graduate of Friona High School, is the son of Mr. and Mrs. Bob Finley. He has been active in the collegiate F.F.A. and has been on the Dean's Honor List.

Library Report

"Power and the Presidency" edited by Philip C. Dolce and George H. Skau is available at Friona Public Library.

These are some of the questions posed in this provocative book:

Why and how did this happen?

How have the Presidents used their power?

Should we limit Presidential power?

What are the alternatives?

Originally part of a CBS-TV series entitled "The American Presidency: The Men and The Office," the essays included here represent the divergent views of leading historians, journalists, and political scientists.

In view of our most recent Presidential crisis, here is a timely and vital book for all Americans.

HAVE YOU HEARD ABOUT INTER-LIBRARY LOAN?

HAVE YOU HEARD ABOUT Millions of books and magazines in 800 or more libraries ... and usually not even a postage cost ... information or recreational reading ... fast service through teletypes and computers ... all AVAILABLE TO YOU! BETTER CHECK UP ON THIS!!! ASK YOUR LOCAL LIBRARY "Good Library Service Through Systems" PAID BY THE TEXAS PANHANDLE LIBRARY SYSTEM & THE TEXAS STATE LIBRARY WITH L.S.A. AND L.S.C.A. FUNDS

These Sponsors Welcome You To Friona's Churches

Church Chuckles by CARTWRIGHT



"Appreciate you dropping by for a visit, Reverend, but got to keep the old body in shape, you know!"

- Rushing Insurance
- The Friona ★ Star
- Friona State Bank
- Friona Consumers
- Friona Motors
- Wilhelm TV & Appl.
- Ethridge-Spring
- Anthony's

- FIRST BAPTIST**
SIXTH AND SUMMITT--REV. C. H. MURPHY
- CALVARY BAPTIST**
14TH AND CLEVELAND--REV. RON TRUSLER
- CALVARY BAPTIST MISSION**
5TH AND MAIN--REV. I. S. ANSLEY, PASTOR
- MEXICAN BAPTIST CHURCH**
4TH AND WOODLAND--REV. DONNIE CARRASCO
- 6th ST. CHURCH OF CHRIST**
502 W. SIXTH--D. L. HARGUESS, MINISTER
- 6th ST. IGLESIA de CRISTO**
408 W. SIXTH--
- 10th ST. CHURCH OF CHRIST**
10TH AND EUCLID

- LUTHERAN CHURCHES**
RHEA AND FRIONA--REV. WILLIAM RUMPEL
- FRIONA UNITED METHODIST CHURCH**
8TH AND PIERCE--BOBBY McMILLAN
- UNION CONGREGATIONAL CHURCH**
EUCLID AT 16TH--REV.
- ASSEMBLY OF GOD**
10th and Ashland-- THOMAS BLEVINS-
- UNITED PENTECOSTAL CHURCH**
5TH AND ASHLAND-- GAYLON CHAPMAN
- MISSION La HERMOSA SPANISH PENTECOSTAL CHURCH**
903 WASHINGTON--REV. ADOLPH PADILLE
- ST. TERESA'S CATHOLIC CHURCH**
16TH AND CLEVELAND--FATHER DERMONT O'BRIEN

OPEN 24 HOURS

ALLSUP'S CONVENIENCE STORES

SHOP ALLSUP'S FOR POCKET PLEASING BUYS!

PRICES GOOD THRU TUESDAY, MAY 17

	LIMEADE	MINUTE MAID	4 6 OZ. CANS	\$1.09
	STEREO TAPES	ASST. 8 TRACK	EACH	\$1.99
	YOGURT	BORDEN'S ASST. FLAVORS	3 8 OZ. CTNS.	\$1.00
	ICE CREAM	BORDEN'S	1/2 GAL. RD. CTN.	\$1.09
	SAUSAGE	SWIFT'S BROWN 'N SERVE	8 OZ. PRG.	79¢
	BACON	SAVORY	LB.	69¢
	BUY A PEPSI			49¢
	GET A GLASS			FREE
HOT COOKED FOODS				
• BBQ CHICKEN	• BBQ RIBS	• MILD LINKS	• CORN DOGS	• BULK BBQ BEEF
• HOT LINKS	• BURRITOS	• BULK BBQ BEEF	• BBQ BEEF SANDWICHES	
CLAY POTS EACH 99¢				
SHOP THE FRIENDLY, CONVENIENT ALLSUP'S STORE NEAR YOU!				
SUP'S OPEN 365 DAYS DONUTS BAR-E				
FRIONA, TEXAS				

WIFE Organization Elects Officers

The area chapter of Women Involved in Farm Economics (WIFE) elected officers recently at a special meeting in First State Bank.

Officers for 1977 are Mrs. Era Louise Jamerson, Bovina, president; Mrs. Jimmie Briggs, Lazbuddie, vice president; Mrs. Doris Ford, Farwell, recording secretary; Mrs. Alma Clayton, Bovina, corresponding secretary; Mrs. Irene Anthony, Friona, treasurer; Mrs. Lou Nuttall, Bovina, historian; and Mrs. Ellen Marie Estes, Bovina, spokesman.

Appointments were made for critical areas, as follows: Mrs. Jimmie Briggs, national steering committee; Mrs. Irene Anthony, consumer affairs; Mrs. Bernice Norton, Farwell, and Mrs. Ellen Marie Estes, national legislation on agriculture; Mrs. Joyce McGehee, Lazbuddie, state legislation on agriculture; Mrs. Bernice Norton, world market prices; Mrs. Sandy Ware, Bovina, OSHA, and Mrs. Brenda Riddle, Bovina, commodities.

A Texas WIFE delegation will leave on Saturday, May 21, to meet with members of Congress. Any

persons wishing to participate is requested to contact Mrs. Estes in Bovina, telephone 238-1349.

Interested persons are urged to send mailgrams, make phone calls and write letters to their congressman. Mrs. Doris Ford, Farwell, has the addresses and phone numbers of these representatives.

The area WIFE chapter plans to hold a regular meeting on the third Monday of each month at 8:00 p.m. CDT at the Bovina bank. The group invites everyone to attend the meetings and participate in chapter activities and goals.

For this month only, the meeting date, time and place have been changed.

The association will meet on Monday, May 16, at 7 p.m. in Bovina Schools cafeteria for a business meeting. At 8:00, Albert Hart of Lubbock, executive vice president, Grain Producers Association, will speak to the group.

Hart has been in Washington recently in an effort to promote legislation concerning grain sorghum and grain and his talk should be of widespread interest.



CAROLYN WISEMAN



KEVIN WISEMAN

Wiseman Couple To Receive Diplomas

Two Friona students at Wayland Baptist College will participate in graduation ceremonies May 14 at 10 a.m. in Herral Memorial Auditorium on campus.

Receiving her Bachelor of Arts degree will be Carolyn Kay Murphree Wiseman, a music education major. She is the daughter of Mr. and Mrs. Curtis Murphree.

Also, receiving his Bachelor of Science degree will be Kevin Lynn Wiseman, a physical education major. He is the son of Mr. and Mrs.

Buddy Wiseman.

Commencement speaker will be the Rev. Chong Man Ahn, pastor, Tehheung Baptist Church, and a teacher at the Korean Baptist Seminary, both located in Taejon, Korea. An honorary doctor of divinity degree will be conferred on Ahn during the commencement ceremony.

Wayland President Dr. Roy C. McClung will give his traditional parting words prior to the singing of the school's alma mater.

Rhea Club Met In Taylor Home

The Rhea Home Demonstration Club met at the home of Mrs. Norman Taylor on Monday, May 9, at 7:30.

Joan Carson gave a 4-H demonstration on CPR and Joanne Mesman, a demonstration on public speaking, the title of which was "America For Me."

There was a log cookout where steak, baked potatoes, salad, French bread and homemade ice cream, were served.

The club voted to give first place prizes for the 4-H dress revue to be held on June 30.

Laura Bartlett gave a report on the H.D. Council meeting held on May 2 concerning the health fair and garden workshop.

T.H.D.A. voting delegates were elected to go to the state convention in Galveston in September. They are Sherri Jones and Laura Bartlett. Alternates are Angela Mace and Laquita Garner.

There will be an election of new officers at the September 12 meeting at the home of Mrs. Elmo Dean.

Jana Pronger gave reports on the Lubbock and Amarillo workshops on communications and problems in family life.

Mardee Grissom was presented a going-away present.

A committee was elected to plan a July 4 celebration.

Those present were Mrs. Keith

Stephens, Mrs. Norman Taylor, Mrs. Cordie Potts, Mrs. Jay Potts, Mrs. Shirley Smith, Mrs. Keith Garner, Mrs. Walter Potts, Mrs. Walter Schueler, Jana Pronger, Mrs. Herbert Schueler, Mrs. Floyd Schlenker, Mrs. Melinda Schlenker, Mrs. Ray Potts, Mrs. Raymond Drager, Mrs. Randy Cain, Mrs. Elmo Dean, Mrs. Earl Schlenker, Mrs. Houston Bartlett and Mrs. Herman Grissom.

Guests were Sherman Taylor, Joan Carson, Joanna Mesman, M.H. Carson, Arnold Hromas and Tammi Smith.

L. Anthony

Rewarded

Elzie Jenkins, vice-president of Cal-Western Life Insurance announced today that Larry E. Anthony has been placed in the company's Top 10 of the National Sales Force. This is the second consecutive month that Larry has been placed in this select group this year.

In addition, Mr. Bob Rever CLU, Vice-President of Marketing, was in Dallas this past week and personally presented Larry with an award for his fine service.

Harper Graduates

With High Honors

More than 2,000 students will receive bachelor's, master's and doctor's degrees in commencement exercises at Texas Tech University this spring.

The 1,000th doctorate and the 10,000th master's degree will be conferred this spring.

Darlene Harper of Friona is among the graduates. She will receive her B.A. degree in math. Her parents are Mr. and Mrs. Clifford Harper of Friona.

She has a minor in English, twelve hours of decision sciences and has work experience in teaching and engineering.

Darlene is an honor graduate, having earned a 3.75 grade point average. She has been on the Dean's

List four years and has earned the Texas Tech Freshman Vaedictorian Scholarship.

She is a 1973 graduate of Friona High School and is presently employed by Texas Tech as teacher assistant while working on master's degree in operations research.

With an enrollment of more than 22,000 students, Texas Tech University includes the colleges of Agricultural Sciences, Arts and Sciences, Business Administration, Education, Engineering and Home Economics, the Graduate School, the School of Law, and the Texas Tech University School of Medicine. It is one of four major multi-purpose universities of the State of Texas.



DARLENE HARPER

Son Born To Mark Walters

A son was born to Mr. and Mrs. Mark Walters of Hereford at 11:57 p.m. on Wednesday, May 4.

The child was born in High Plains Baptist Hospital, Amarillo. He weighed eight pounds, 6 3/4 ounces. His name is Coby Brian and he is the first child for the couple.

Grandparents are Mr. and Mrs. Joe A. Walters of Friona and Mr. and Mrs. Bill Salmon of Marlow, Oklahoma. Great-grandparents are Mr. and Mrs. Buck Salmon of Cushing, Okla., Mr. and Mrs. Herman Feichtl of Cherryvale, Kansas, Mr. and Mrs. Edgar Walters of Friona and Mrs. James Evans of Hereford.

The child has one great-great-grandmother, Mrs. D.T. Jordan of Morton.

Choose from a bouquet of patterns and save during our annual OPEN STOCK SALE International Fine Stainless



Save 33-1/3% On all open stock place setting and serving pieces.

The choice is yours, the patterns are International favorites. Take this opportunity to bring elegance and beauty to your table. Whether you're adding on or completing your present set, or starting a new one, you'll save during this limited time sale on all pieces. For example, a 5-piece place setting that normally sells for \$25.00 is now only \$16.65. Come in today and save.

THE ONE & ONLY & BROWSABOUT

719 Main PHONE 247-3282

Telex Is Helping Make May Better Hearing And Speech Month More Successful.

To make Better Hearing and Speech Month more meaningful to the more than 11 million Americans who have uncorrected hearing problems Telex makes the following offer for May only

1. Instead of the normal one-year warranty Telex will give full two-year warranty.
2. Telex will provide free of charge to the user Accidental Loss/Damage insurance coverage for one year.
3. 30-day trial on all instruments.

LET'S ALL WORK TOGETHER CLOVIS HEARING AID CENTER

403 East 14th St. Phone 763-6900 Clovis, New Mexico

PRICES GOOD WEEK OF MAY 16 THRU MAY 21

STAND OUT Gifts for Grads

KODAK EK-4 INSTANT CAMERA \$53.50 Value \$49.95

KODAK CAPRICE POCKET SIZED INSTANT CAMERA ONLY \$9.95

NORELCO ROTARY RAZOR \$33.95 \$39.95 Value

REMINGTON RADIAL RAZOR \$44.95 \$49.95 Value

LADY NORELCO TRIPLE HEADER RAZOR \$19.95 \$24.95 Value

NORELCO SHAPE 'N DRY \$24.50 \$26.95 Value

CONAIR 500-Watt HAIR DRYER \$14.99

CLAIROL LIGHTED MAKE-UP MIRROR \$17.50 \$18.99 Value

OLD SPICE COLOGNE 4 3/4 Oz. \$3.00

STEPHEN B. PURE SPRAY COLOGNE \$4.00 Value \$3.50

NUANCE PERFUME 4 Oz. \$7.00

CHARLIE & JONTUE BODY SILK SOAPS \$5.00 Value \$4.50

ADRIENNE POWDER \$1.75

FULL LINE OF TIMEX WATCHES FROM \$14.95 to \$32.95

BI-WIZE DRUG

Town Talk

By June Floyd

Phone 247-3681

With Your News Item



Jan Edelman, daughter of Mr. and Mrs. W.L. Edelman, is visiting her parents and other relatives and friends. She has been attending Goodard College at Cambridge, Massachusetts, and has received her Master's Degree in Women's Studies.

Thursday of last week Jan and some other former Friona High School students had a real fun day in Lubbock. Jan and Phila May Buske Weatherly went to Canyon and picked Lila Gay Buske Vars up and the drove to Lubbock where they met Betty Agee Wetzel of Midland for lunch.

Then after school was dismissed the group went to the home of Linda Gee Houston for a get-together.

Several of our college age people are home. Some of them for the summer and others for brief stays. Pattijon Talley, who attends Baylor University, Waco, is home, but plans to attend the first session of summer school, so will be leaving before very long.

Pattijon had a very interesting experience and probably the most frightening experience of her life recently.

During the pre-wedding festivities for her brother, Rex, and his wife, Karen, whose home is in Roanoke, Virginia, Pattijon met Gary McCormick, who was attending West Point Military Academy at West Point, New York.

This spring he invited her to West Point for the ring weekend festivities. Each spring the junior students are honored with parties for the weekend. Highlight of the event is the Ring Dance on Saturday evening. Music for the dance was furnished by the United States Army Band.

Other festivities for the honored cadets and their dates were a dance Friday evening, a brunch Sunday morning and chapel attendance Sunday morning.

The entire weekend, with the exception of a harrowing experience Thursday afternoon, was fun, fun, fun.

Original plans were for Pattijon to fly from Dallas-Fort Worth Airport to Newark, New Jersey and then ride a bus to Port Authority Bus Station. Engine trouble and an emergency landing at Memphis, Tennessee, changed her plans.

The plane she was on from Memphis to New York landed at La Guardia Field, which is about 45 minutes or so from Port Authority. She had been advised to take a cab,

which she did. However, she had no way of knowing the cab was not an official one.

The driver and another man in the cab drove around awhile under the pretext of showing her the town. Then demanded "Your money or your life." She immediately gave them her money and was allowed to walk away unharmed with her luggage.

After asking for direction, she walked to Port Authority and contacted the police department and reported the incident.

Myrl Buske has been a busy woman this spring. She spent some time visiting her daughter, Deann, and her family in Tennessee. Then came home and had company for a week.

Vangelin James, Memphis, Tennessee; Felix Snipes, Atlanta, Georgia; and Mr. and Mrs. J.L. Watson and Mrs. Kerry Powell, all of Forrest City, Arkansas, were her houseguests.

Mother's Day she was a special guest in the home of the Philip Weatherlys. Other guests were Mr. and Mrs. B.K. Buske.

Mrs. D.O. Robason of Siloam Springs, Arkansas, has been here. She spent ten days with Patsy and Calvin Talley. Other recent guests in the Talley home were Mr. and Mrs. Cecil Oekerman of Midland. Mrs. Oekerman is Calvin's niece.

Sunday Calvin and Patsy took Jewel to Amarillo to catch a plane home. Dr. and Mrs. Easton Wall of Dumas joined them in Amarillo for lunch. Mrs. Wall is the former Lila Talley. Dr. Wall is the superintendent of schools in Dumas.

Ralph and Beulah McBroom should have a yard full of California geraniums blooming in their yard before too long. They returned home recently after spending a couple of weeks or so visiting her mother and other relatives and friends in California. I think everyone they visited must have given them geraniums.

They spent some time in Las Vegas and did some sightseeing on the way to the West Coast and back.

Tom Gee is visiting his parents, Mr. and Mrs. J.T. Gee. He is a registered nurse and has been working in the Portland area several years.

When he leaves Friona, he will go to San Juan, Puerto Rico, where he has enrolled in the anesthesia

department of Ashford Medical Center.

I'm not sure what his designation will be, but when he completes his courses, he will be an anesthetist.

Mother's Day dinner guests in the home of Mr. and Mrs. L.P. Davis were Mr. and Mrs. Bob Davis and Melia of Amarillo; Margo Davis of Hereford; and Mr. and Mrs. George Bentley of Bovina.

Mrs. Dess Fallwell of Little Rock, Arkansas, is visiting in Friona. She lived here a long time, but has been gone a few years.

She is the mother of Artis Fallwell and has a lot of other relatives here. She also visited Mr. and Mrs. Ervin Henderson, who are long time friends.

Farmers should be very interested in trying the new drink, which will be on sale in Denver in the not too far distant future. It is being made from a wheat-coffee blend. Then, there's another one reported to be on the way. It is being tested for the retail market in a few cities and is being developed from okra seeds.

If we like that one, maybe we can just grind our own okra seeds like we used to grind coffee. Does anyone have a coffee grinder? We may need them.

A friend is one who comes in when the rest of the world goes out.



TERRI BINGHAM will graduate from Baylor University at Waco, Texas on Friday, May 13. Commencement exercises will be held at 10 a.m., in the Heart of Texas Coliseum. She will receive a B.S. degree in secondary education, with teaching fields in English and business. She is the daughter of Mr. and Mrs. John Bingham and a 1973 graduate of Friona High School.

Eighth Graders Have Party In Osborn Home

On Friday evening, May 6, members of the Junior High School graduating class were entertained with a garden party at the home of Monique Osborn.

The party area was decorated with the school colors and spring flowers. The dance area was marked off by a white trellis decorated with red bows, birds and streamers with a large white heart in the background. Other activities included playing ping pong and lawn bowling. Two favorite places were the trampoline and a swing with flower garlands decorating the chains and a red velvet covered seat.

The serving table was covered with a white linen cloth centered with an arrangement of white snowballs and red carnations. Punch, cake, cookies and party mix were served to approximately fifty

guests. Assisting with the preparations and serving were Allison McMillan, Kathy Chesher, Tammi Smith, Mrs. Ernesteen Skipworth, Mrs. Ann Kelley, Sally Wilkerson, Mr. and Mrs. Arthur Drake and Monique's parents, Mr. and Mrs. Forrest Osborn.

THPT Sets Open House At Bovina

Weldon Moody, who will observe his 25th consecutive year with the State Department of Highway and Public Transportation on June 16, is inviting the public to drop by and inspect the department's facilities on Tuesday, May 17, from 10 a.m. until 6 p.m. This, he said, is a part of the observance of National Transportation Week.

Governor Dolph Briscoe recently signed a proclamation designating the week of May 15-21 as National Transportation Week and, in requesting heads of local governments to follow his lead, noted the critically important position that transportation holds in the economy of the state and the job that must be done in maintaining the state's more than 71,000 miles of roads.

Friona Mayor R.L. Fleming has signed the proclamation and, in so doing, urges all citizens to lend their support to the State Department of Highways and Public Transportation.

Moody, while stressing the job done by his department, year in and year out, also divulged another side not necessarily known generally. He said that nine local employees are fully trained in multi-media first aid and he was to be in Lubbock this past Tuesday to conduct a training course in a class of 22 employees.

After department employees are certified competent, Moody will begin training area volunteer firemen in the various techniques of MMFA.

Sing 'N To Honor Older Citizens

In honor of Older Texans Month the Parmer County Home Demonstration Council and Bovina Young Homemakers are sponsoring an Old Fashioned Sing 'N and Fellowship, Saturday, May 21, from 2 to 4 p.m. in the Fellowship Hall of the First Baptist Church in Bovina.

County will be special guests and the public is invited to attend. Special recognition will be given the oldest persons attending, the longest resident of Parmer County and the couple married the longest.

In addition to group singing and special recognitions, the activity will include refreshments, entertainment and a lot of good visiting and fellowship.

For more information or transportation to the event call: Bovina and Oklahoma Lane—Darlene Caldwell, 238-1594; Bobbie Pierson, 825-3663; or Sharon Eubanks, 825-3977; Friona and Rhea—Cecelia Schueler, 295-3855; Helen Potts, 295-3887; Mae Magness 247-3861; Mrs. J.T. Gee, 247-3162; Lora Mae McFarland, 247-3741; or Debbie Shirley, 247-3922.

Friona Bands Set Spring Concert

The Friona Bands Spring Concert will be conducted at 8 p.m. Thursday in the Junior High Auditorium.

On the program will be the fifth grade band playing Boogie Woogie Bugle Call and Civil War Patrol. The sixth grade will do Citadel March, Day By Day and Meadowlands.

The seventh grade will perform The Now Explosion, Bonarte's Retreat, and Kentucky-1800. Eighth grade selections include Winchester March, Superstar and Joi.



The Chieftain Band will play Neddermejer Triumphal, A Festival Prelude, MacArthur Park and First Swedish Rhapsody. Also on the program is the Stage Band which

Don't SPEND the summer here ...

Save here & now

SAVE \$30

With a gas grill on the patio, cooking heat stays outside so your house stays cool inside and you save on air conditioning. You save on cooking mess, too. Just set the controls, touch a match to the burner and enjoy tasty charcoal flavored foods. No mess. No bother.

Buy one of these grills before August 1, 1977 and save \$30!

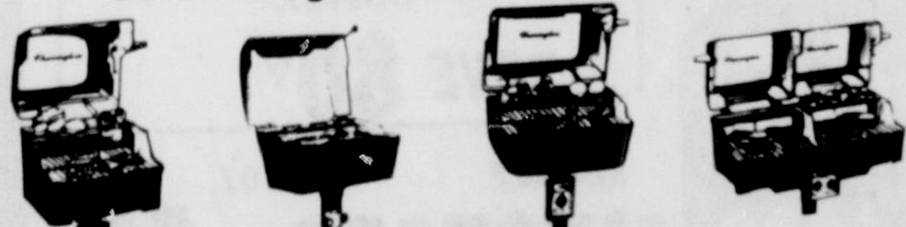

MASTER CHEF AMK	FLAVOR TWIN	PARTY HOST TWIN	CHEF'S CHOICE CC-1
(Charmglow 2000) A popular priced grill with 351 sq. in. of cooking surface. You set the heat you need with a turn of a knob. Special H-shaped burner and permanent briquettes heat entire cooking area evenly.	(Arka GRB-40) Unique dual burner, regulated by individual heat controls, lets you heat either half of the grilling area separately from the other half. never uses more gas than you need. 455 sq. in. cooking surface.	(Charmglow 3200) Twin burners for different cooking temperatures on either side of grill. exclusive single dial control operates two burners independently or together for cooking versatility and economy. 461 sq. in. cooking surface.	(Charmglow 4300) Double cooking convenience using one or both units. each has its separate controls. A complete outdoor "range" with all the cooking surface you need - a total of 702 sq. in.
List price \$202.95 NOW SAVE \$30.00 Discount price \$172.95 5% sales tax \$ 8.67 Cash price \$181.62 Budget price* \$219.96	List price \$258.02 NOW SAVE \$30.00 Discount price \$228.02 5% sales tax \$11.40 Cash price \$239.42 Budget price* \$299.84	List price \$258.89 NOW SAVE \$30.00 Discount price \$228.89 5% sales tax \$11.45 Cash price \$240.34 Budget price* \$299.96	List price \$369.99 NOW SAVE \$30.00 Discount price \$339.99 5% sales tax \$16.99 Cash price \$356.98 Budget price* \$431.94
Budget terms: no down payment, \$6.11 per month for 36 months.	Budget terms: no down payment, \$8.04 per month for 36 months.	Budget terms: no down payment, \$8.11 per month for 36 months.	Budget terms: no down payment, \$11.99 per month for 36 months.

*Prices include normal post-type installation and 5% sales tax. *Budget terms are available at 12.75% annual interest on declining balance.
Call Pioneer or ask any Pioneer employee. PIONEER NATURAL GAS COMPANY A Division of PIONEER

Thursday, May 19th

9 99¢

KING SIZE WALLET CREATIVE COLOR PORTRAITS FOR ONLY

Kodak paper. For a Good Look at the Times of Your Life.

Extra Charge for GROUPS WE USE KODAK PAPER

GET PICTURES MADE OF GRANDPA, GRANDMA, DAD, MOM AND ALL THE LITTLE ONES AT THESE SAME LOW PRICES!

ASK About Our FREE 8 x 10 OFFER

SHUGART COLOR PHOTOS

HOUSER GROCERY
9th & MAIN

29th Anniversary 29th

CONGRATULATIONS TO NORA HUFFSTICKLER

Who Was The Winner Of Our Second Week's Gift Certificate

Come In And Register Daily, You May Be A Winner Also

NO PURCHASE NECESSARY

Don't Forget Our ANNIVERSARY Discount On Sale Stainless Steel

Also The Merry Month of May Franciscan Sale 40 Per Cent Off On 3 Pc. Place Setting

20 Per Cent Off On Selected Open Stock Items

Give something special... BULOVA

Engraveable oval within swirl motif. \$7.95 & Up Engraved free

GIFT BOXED

AUTO KEY PROTECTOR Great for any driver! Click! Separates car key from personal keys. Convenient! Safe!

Name's Are Being Drawn Daily

For Our Fun Grab Bag

ALLEN'S JEWELRY

Serving Our 30th Graduation Class In Friona

609 Main Friona Phone 247-2830

WIN CASH!

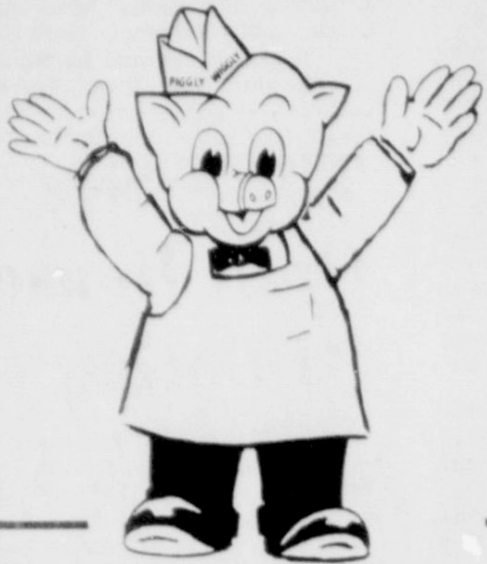

**PLAY
PIGGLY
WIGGLY'S**

**JACK
POT** WIN **\$50.00**
LAST WEEK'S \$100.00 CASH WINNER
MRS. LUCILLE ROCKY

USDA CHOICE **1/2 BEEF**
CUT & WRAPPED TO YOUR
SPECIFICATIONS
APPROX. 175 - 225 LBS. **79¢**
LB.

USDA CHOICE **CHUCK**
BOXED BEEF
CUT & WRAPPED APPROX. 75 - 95 LBS.
CONTAINS
CHUCK ROAST ARM ROAST
EXTRA LEAN GROUND BEEF
STEW MEAT **76¢**
LB.

USDA CHOICE **BONELESS**
BOXED BEEF **CHUCK**
CUT & WRAPPED
APPROX. 75 - 95 LBS.
CHUCK ROAST ARM ROAST
SWISS STEAK CUBE STEAK
EXTRA LEAN GROUND BEEF **88¢**
STEW MEAT LB.

USDA CHOICE
BEEF FREEZER PACK
25 LBS.
10 LBS. ROAST **\$24.95**
10 LBS. STEAK
5 LBS. EXTRA LEAN GROUND BEEF



SHURFINE
CR. POTATO
O.F. VEG.
CR. CELERY
10 1/2 OZ. CAN **16¢**
SUE BEE
HONEY 2 1/2 LB. JAR **\$2.39**



USDA CHOICE BEEF **ROUND STEAK** LB. **\$1.19**
USDA CHOICE BEEF BONELESS **ROUND STEAK** LB. **\$1.49**
USDA CHOICE BEEF BONELESS **SWISS STEAK** LB. **\$1.19**

IMPERIAL or HOLLY
SUGAR
5 LB. SACK **99¢**
LIMIT 1

WELCH'S GRAPE
JELLY
20 OZ. DEC. **69¢**

USDA INSP.
FRYERS
TWIN PACK LB. **47¢**

BONELESS
CHUCK ROAST
USDA CHOICE LB. **99¢**

PORK SAUSAGE
SHURFRESH 1 LB. BAG **89¢**
2 LB. BAG \$1.77

MORTON FROZEN
POT PIES
BEEF CHICKEN
TURKEY
5 FOR **\$1.00**

MORTON FROZEN
DINNERS
BEEF
CHICKEN
SALS. STEAK
TURKEY **49¢**

SHURFINE
CORN FLAKES 18 OZ. BOX **75¢**

SHURFINE
CRISPY RICE 13 OZ. BOX **87¢**

SHURFINE
SUGAR FROSTED **FLAKES** 15 OZ. BOX **86¢**



DEL MONTE 15 1/2 OZ. CAN **PINK SALMON** **\$1.69**



SHURFINE 46 OZ. CAN **ORANGE DRINK** **39¢**



CLARDY'S 1/2 PINT **WHIPPING CREAM** **39¢**



CLARDY'S 1/2 GALLON **BUTTERMILK** **69¢**



SWIFT NO BEANS 15 OZ. CAN **CHILI CON CARNE** **49¢**



FOODKING SALTINE 1 LB. BOX **CRACKERS** **44¢**



DEL MONTE CUT 303 CAN **GREEN BEANS** 3 FOR **89¢**

USDA CHOICE
SIRLOIN TIP STEAK
TENDERIZED LB. **\$1.49**

THIS COUPON WORTH \$2.00
WITH PURCHASE OF ONE
50 LB. SACK GRAVY TRAIN
DOG FOOD
SAVE \$2.00

THIS COUPON WORTH 30¢
WITH PURCHASE OF ONE
100 COUNT BAGGIES FOOD
STORAGE BAGS
SAVE 30¢

THIS COUPON WORTH 80¢
WITH PURCHASE OF ONE
1 LB. CAN MARYLAND CLUB
COFFEE
SAVE 80¢

CUCUMBERS
LARGE SLICERS
EACH **15¢**



CALIFORNIA **AVOCADOS** 3 FOR **65¢**

WASHINGTON RED DELICIOUS **APPLES** 3 LB. BAG **\$1.00**

PIC O MORN BUBBLE PACK LB. **TOMATOES** **49¢**

RED BOY 16 OZ. **MUSTARD** **48¢**

BRECK **SHAMPOO**
7 Oz. **\$1.09**
Reg. \$1.59

MAALOX ANTACID
12 Oz. **\$1.69**
Reg. \$1.99

GILLETTE TRAC II **SHAVIN BLADES**
9's **\$1.89**
Reg. \$2.33

VASELINE Intensive Care **LOTION**
6 Oz. **99¢**
Reg. \$1.25

OPEN DAILY
11 9:00
DOUBLE S&H GREEN
STAMPS ON WEDNESDAY



WHITES AUTO

Prices effective
through May 21, 1977

Think Summer Savings

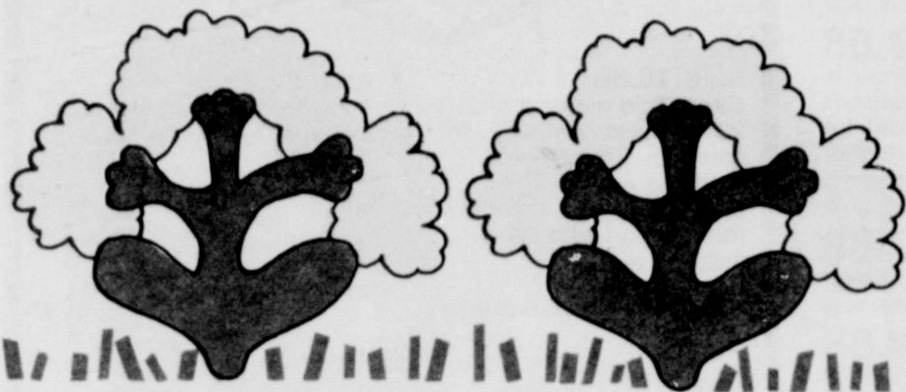

B.F. Goodrich



Tire Size	F.E. Tax	Reg. Price	Sale Price
FR60-14	2.84	\$76.88*	\$61.00*
GR60-14	3.27	\$80.88*	\$65.00*
FR60-15	2.98	\$78.88*	\$63.00*
GR60-15	3.33	\$81.88*	\$66.00*
LR60-15	3.59	\$91.88*	\$74.00*

* Plus F.E. Tax

Save on B. F. Goodrich Radial T/A 60 performance tires

- Two radial plies and four sturdy belts of Dynacor® rayon cord!
- Bold raised white letters, one side with raised black letters on reverse sidewall!
- Wide footprint, 60 series profile for excellent stability!
- 9 rib block tread for excellent traction!

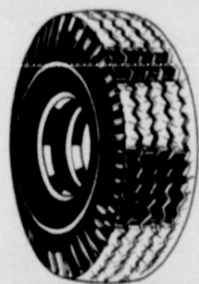

4 ply boat trailer tires

Tough, long wearing nylon tube-type tires for your boat trailer.

Tire Size	F.E. Tax	Reg. Price	Sale Price
400/480-8	51c	\$9.88*	\$8.88*
500/570-8	97c	\$14.88*	\$13.88*
400/480-12	73c	\$14.88*	\$13.33*

* Plus F.E. Tax

Cobra

sale \$139
Reg. 169.95
Save 30.95



Cobra 21XLR 40 channel CB delivers a crisp, clean, clear signal — whether transmitting or receiving. It has MAXIMUM LEGAL POWER for top performance and extra range. Features Dynamike gain control, adjustable squelch, switchable automatic noise limiter, large S/R/F meter plus space age L.E.D. readout with dimmer. P.A. capability. 16-1133



sale 1.99
Auto coolant saver kit prevents coolant loss & overheating, seals cooling system and removes air for lower engine operating temperature. Easy to install. 1-299

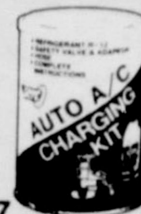

sale \$3.77
Save \$1 Reg. 4.77
Auto air conditioner service kit contains 15 oz can of refrigerant, safety can valve and 18" hose. Complete instructions included. 5-16



sale 53c qt.
Pennzoil motor oil. Choose 20 or 30
Wt. 46-302-304



sale 69c ea.
Champion spark plugs. Resistor plugs slightly higher. 30-300-331



sale 1.66
White oil filters in sizes to fit most U.S. cars. Change filters often to prolong engine life and reduce repair bills! 44-611-645



sale 59c
Chex concentrated oil treatment quiets valves, retards oil consumption, prolong engine life. 5-565

Whites has it!

Famous
name brands
at bargain
prices

Charge it!
Whites EZE credit plan.





sale 19.88
Patio or den end table is solid wrought iron. Baked on white enamel finish for lasting beauty and durability. 83-31

sale 39.88
Wrought iron club chair in fresh blue floral design features tufted box edge cushions for style and comfort. Weather resistant baked on white enamel finish. 83-82

sale 19.88
Matching wrought iron ottoman for club chair. 83-35

sale 69.88
Save \$10 Reg 79.88
Matching wrought iron love seat. 83-34



sale 54.88
Save \$5 Reg 59.88
Matching wrought iron swivel rocker. 83-33

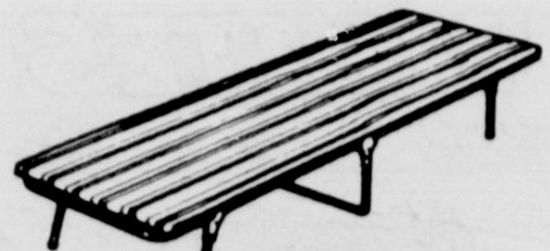
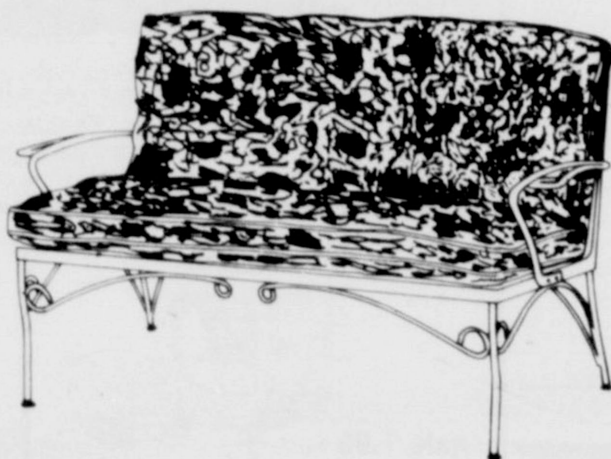

sale 16.88
Camp bed measures 72" x 23" — folds compactly for carrying. 1 inch foam mattress on 1 inch aluminum frame combines real comfort with sturdy support. 83-184

sale 22.88
4 leg folding bed with 2 inch mattress. 83-186



sale 38.77
Save 6.18 Reg 44.95
Smoker type charcoal grill with hinged lid surrounds your meat with hickory smoke for extra flavor. Big 18" x 18" chrome plated grill is adjustable. Wheels for easy moving. 83-269

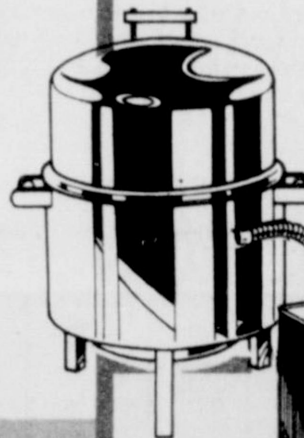

sale 32.88
Single unit smoker grill. Use it for a smoker or bar-b-que. Chrome cooking grid. Flat black finish. 83-271



sale 1.27
One gallon gas can has flexible metal pour spout so you'll never need a funnel! Flip open vent. 85-368



sale 57c
Whites charcoal lighter in handy quart cans fires up your coals in a jiffy! Great for wood fires, too. 83-289



sale 6.77
King size 2 gallon Thermos picnic jug keeps your favorite drinks frosty cold. The extra thick insulation makes the difference! Leakproof liner & fast flow spigot. 85-550



sale 16.88
Save \$3 Reg 19.88
Coleman 38 quart ice chest features high rise lid to handle tall bottles, deep dry storage tray, recessed handles with built-in bottle opener and leak proof drain. 85-667

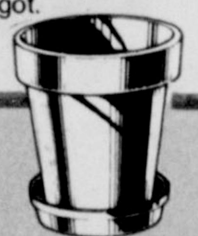

sale 44c
Plastic planters with lock-on saucer. Assorted colors and sizes. 4 1/4" x 4 1/4" size. 70-4135
5 1/4" x 5 3/4" size. 77c
7 1/4" x 7 3/4" size. 1.33
6 1/4" x 4" size. 1.77
10 3/8 x 7" size. 3.44
70-4137, 39, 41, 43



sale 3.97
Fully insulated picnic bag of heavy gauge vinyl with vinyl lining. Keeps foods hot or cold for hours. Choose blue denim or plaid design. 85-660



Save over \$20!!
sale 149.88
Save 20.09 Reg. 169.97
20 inch rear discharge rotary mower has a power-packed 3.5 horsepower Briggs & Stratton engine for plenty of reserve power! Easy pull-n-go starter, wheel height adjustment and extra large grass catcher that locks on tight and releases quickly and easily for dumping. 87-292

Save over \$12!!
sale 97.88
Save 12.09 Reg. 109.97
22 inch side discharge rotary mower is dependably powered by a 3.5 horsepower Briggs & Stratton engine. Just pull the easy recoil starter and AWAY YOU MOW. 4 position cutting height adjustment and "ACTION GUARD" safety features. Whites has it... for lawn care. 87-290

WHITES AUTO

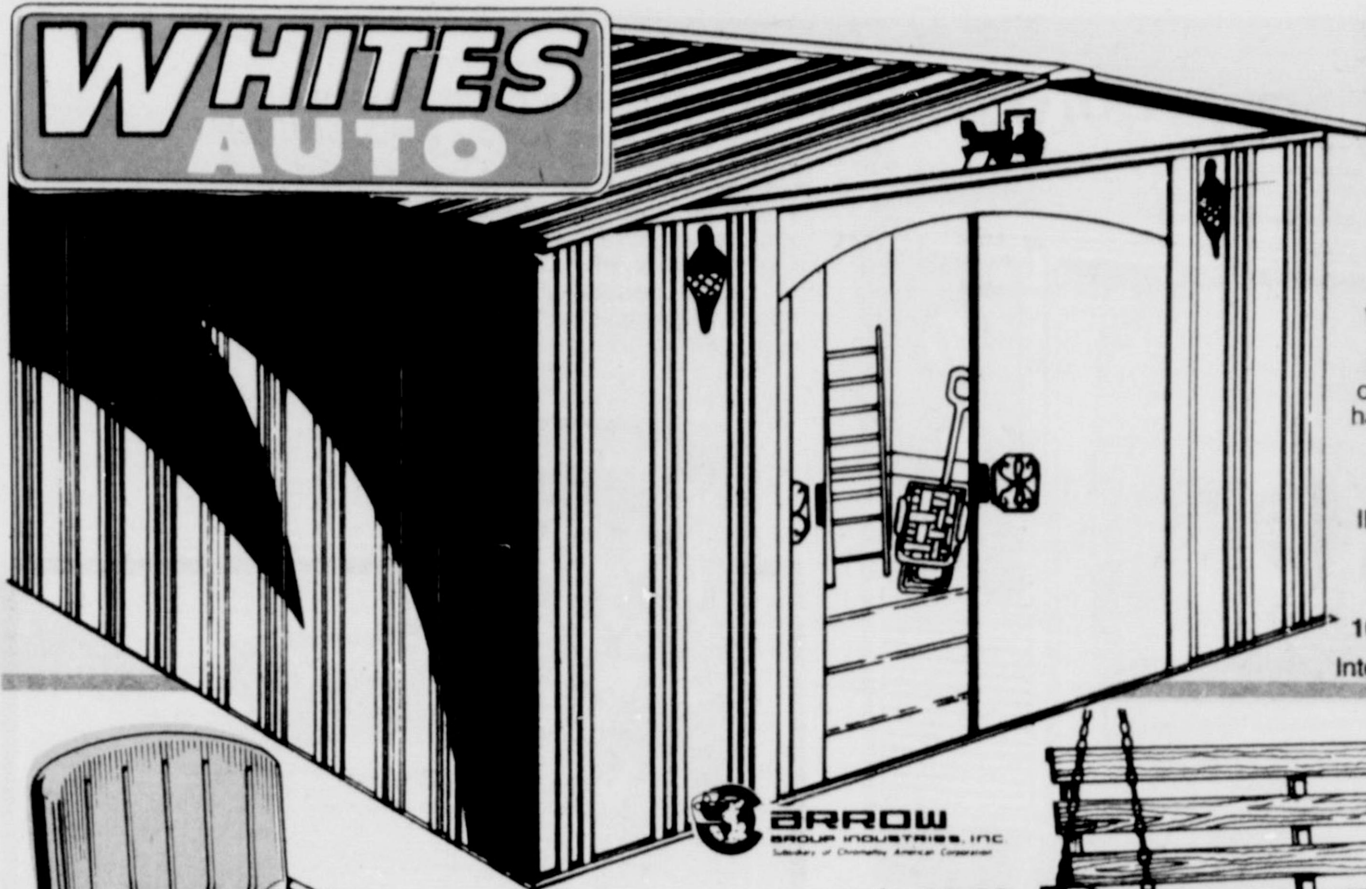

**Our lowest priced
10' x 5' galvanized steel
storage building
sale \$99**

(in the carton)

Regency storage building. Just look inside. You'll be amazed at the space! Plenty of sale, weatherproof storage for gardening equipment, sporting goods, bikes, bar-b-ques — anything that's crowding your garage. Double reinforced one piece sliding door and unbreakable lockable handle.

FINISH: Cleansed steel, galvanized zinc, bonderite coat, chromate film and polyester baked enamel.

INTERIOR DIMENSIONS: 115 1/2"W x 57 3/4"D x 72 3/4"H. 85-881

sale \$149

(in the carton)

10' x 10' galvanized steel storage building. 85-882

Interior dimensions: 115 1/4"W x 111 3/4"D x 72 3/4"H

ARROW
GROUP INDUSTRIES, INC.
Subsidiary of Chromalloy American Corporation

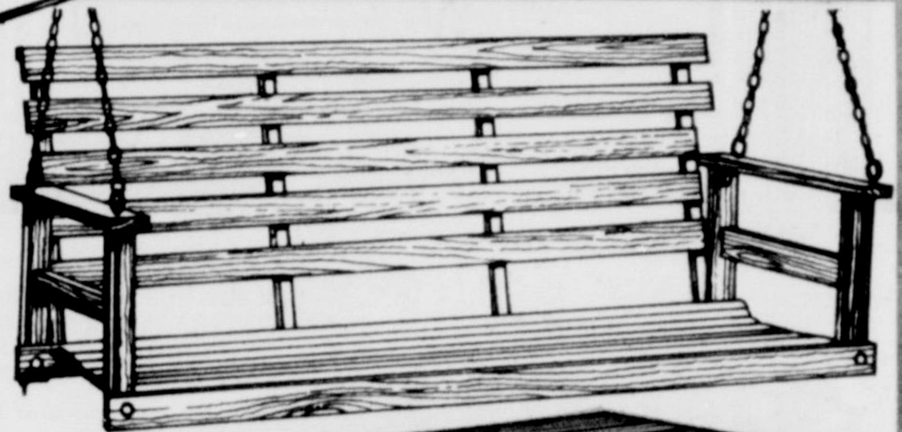

sale 16.88

4 ft lawn swing with room for two adults! It's made of natural finish varnished hardwood and comes complete with hooks and chains. Hang it from a tree limb, on the porch or from the steel A frame which can be purchased separately. 83-75

sale 22.88

Deluxe 5 ft lawn swing has vertical slats. Fashioned from natural finish varnished hardwood and comes with hooks and chains for easy installation. 83-80

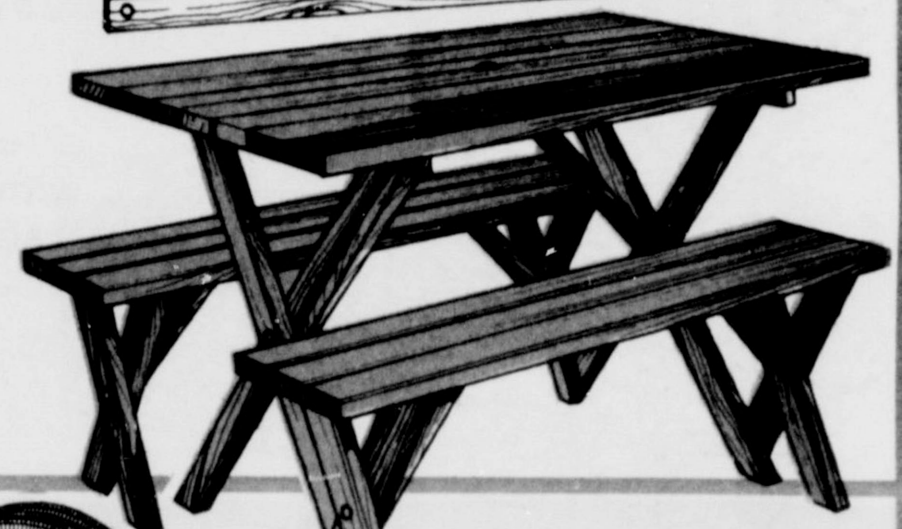

sale 47.88

(in the carton)

5 ft. picnic table constructed of beautiful 2" natural redwood. It's weatherproof. Seats six adults comfortably. Comes with two matching benches. 83-110

sale 77.88

(in the carton)

Big king size 8 ft. redwood picnic table with 2 benches. Seats 10 adults. 83-112

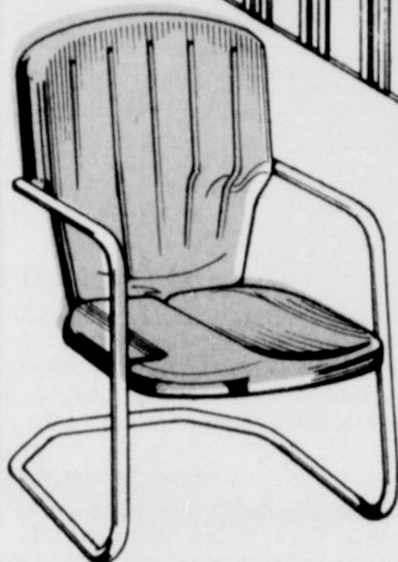

sale 11.88

Save 3.11 Reg 14.99

All steel lawn chair for the pool, patio, yard. Sit in it — it's comfortable! New polyester powder coated finish assures long lasting beauty and durability. Mix or match in green or yellow. 83-42, 43



sale 5.88

Save 1.09 Reg 6.97

Hanging terrarium/aquarium with 7 in. glass bubble suspended from a macrame hanger. A great way to display your plants. 70-4105

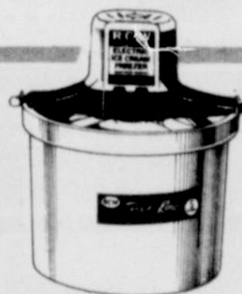

sale 14.88

Electric ice cream freezer does the work for you! Churns out a full gallon of your favorite flavor! 85-720



sale 3.97

Save 1.52 Reg. 5.49

50 ft. nylon reinforced garden hose stays flexible even in cold weather! 1/2" inside diameter. 85-415

sale 3.99

75 ft. 2-ply garden hose.

85-404

**Your choice
sale 2.99 ea.**
Garden rake or hoe. White's own fine quality garden implements with welded heads and sanded wood handles. 85-102, 119

sale 99c

Save 50c Reg. 1.49

5 in. diameter hanging clay planter with sisal hanger. 70-4029



sale 1.66

20 lb. bag potting soil. Bunyan's Miracle Earth is nutrient enriched for healthy plants. Sterilized, odorless, ready to use! 70-4163

sale 6.57

Save 1.38 Reg. 7.95

Impact sprinkler operates effectively even at low water pressures! Vane barrel gives greater distance — covers up to 86 ft. diameter circle. 84-230

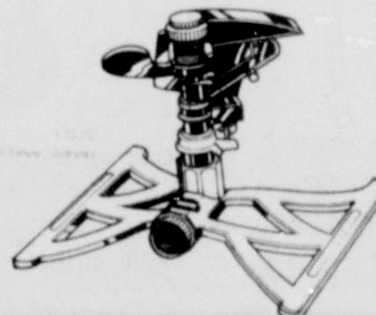

WHITES AUTO

GTE SYLVANIA

Take home this great Sylvania color portable today AND SAVE!!
sale 379.95

19" Sylvania color portable with the exclusive CHROMALINE picture tube delivers a clear, crisp picture with vivid color, and, after all, great color is why you buy it! It's 100% solid state for dependable, low energy operation. Features include perma-tint, click stop UHF tuning & telescoping VHF antenna. Stylish walnut grain finish on high impact plastic. 122-7820



sale \$66

Full size mattress or box spring features POSTUREFLEX innerspring construction. Quality bedding for years of comfort. 222-3120-30

sale \$55

Twin size mattress or box springs with POSTUREFLEX construction. 222-3140-50

Free delivery
within Whites
service area



sale \$119

Save 20.95 Reg. 139.95

3 way recliner is generously foam padded for solid comfort. Stylish diamond tufted back and super soft attached seat. Covered in long wearing, easy to clean brown vinyl.

224-3065

sale 19.88

Multi-band portable radio gets it all — AM, FM, aircraft in flight, police highband and weather! AC or DC operation with AC line cord included. Telescoping antenna. 120-7238



sale 6.77 pair

Save 3.21 Reg. 9.98 pair

5" round flush mount stereo speakers produce rich, full high fidelity sound. 3 oz. ceramic magnets. Deluxe chrome grills. Hardware, wire & instructions included. 16-539



sale 22.88

Save \$7 Reg. 29.88

White 8 track tape player for your car, truck or boat puts your favorite music at your fingertips. Automatic or manual track change with program indicator lights. Mounting bracket and hookup wire included. Easy to install. 16-548

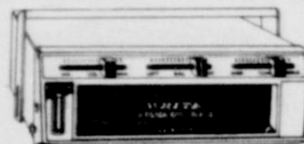

sale \$77

Save 22.95 Reg. 99.95

Contemporary styled 5 piece dinette to dress up your kitchen or dining area! Features stain and heat proof high pressure laminated table top and bronze enamel finish. 4 sturdy chairs. Dimensions: 30"x40"x48" with 1 12" leaf. 226-6035



Whites has it!

CATALINA

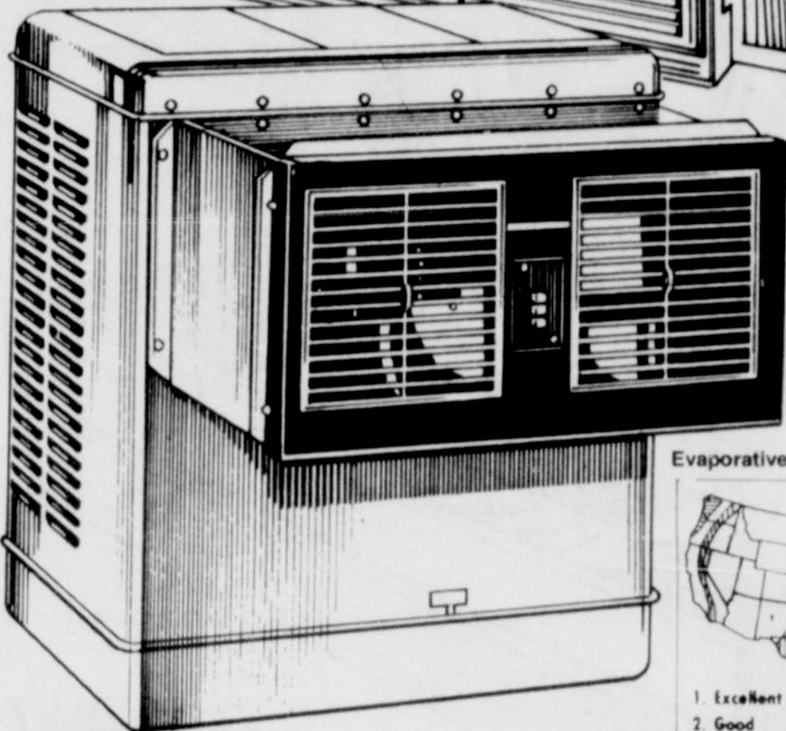
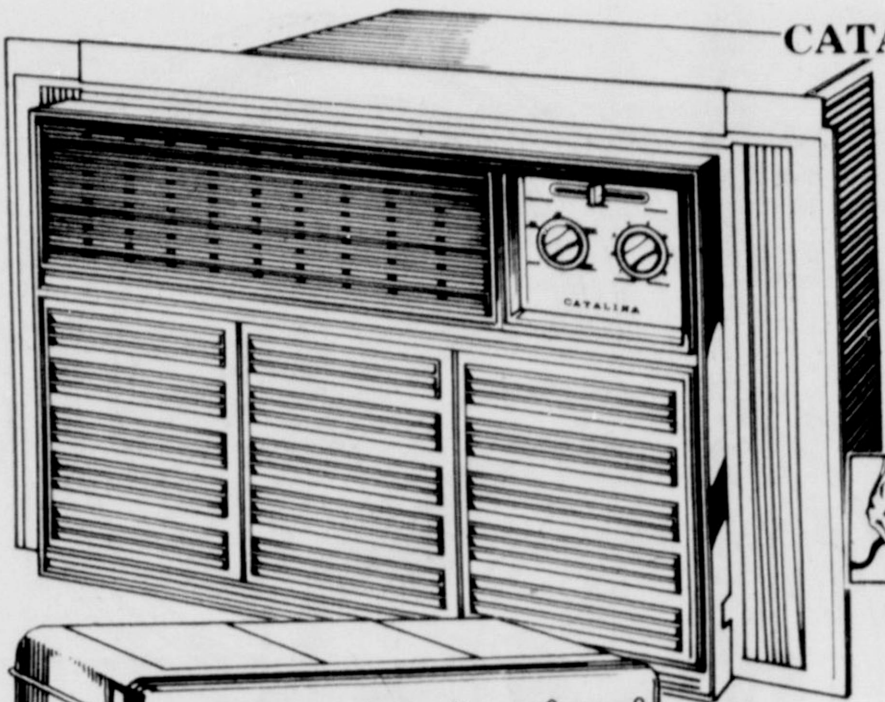

plugs into any 110 volt outlet

Evaporative Cooler Efficiency Chart



- | | |
|--------------|-------------------|
| 1. Excellent | 3. Fair |
| 2. Good | 4. Unsatisfactory |

sale \$114

2800 CFM evaporative air cooler has a rust resistant recirculating water pump, automatic float, twin blowers, three-way water distribution and push button controls. Comes complete with window mount kit. 175-195

Charge it! Whites EZE credit plan,
BankAmericard, Master Charge
Free delivery within Whites service area

Buy this powerful cooling 12,000 BTU/hr air conditioner today and save \$32.95!!

sale \$287

Save 32.95 Reg. 319.95

Our Catalina 12,000 BTU/hr room air conditioner is the most powerful unit we sell that requires no special wiring! Just plug it into any standard 115 volt outlet and enjoy cool comfort on the hottest summer day! 2 speed fan and dual directional air control let you regulate the air flow. Permanent washable filter. Fresh air and exhaust ventilation controls. Fast, easy installation with attached slide-out window panels. 180-7112

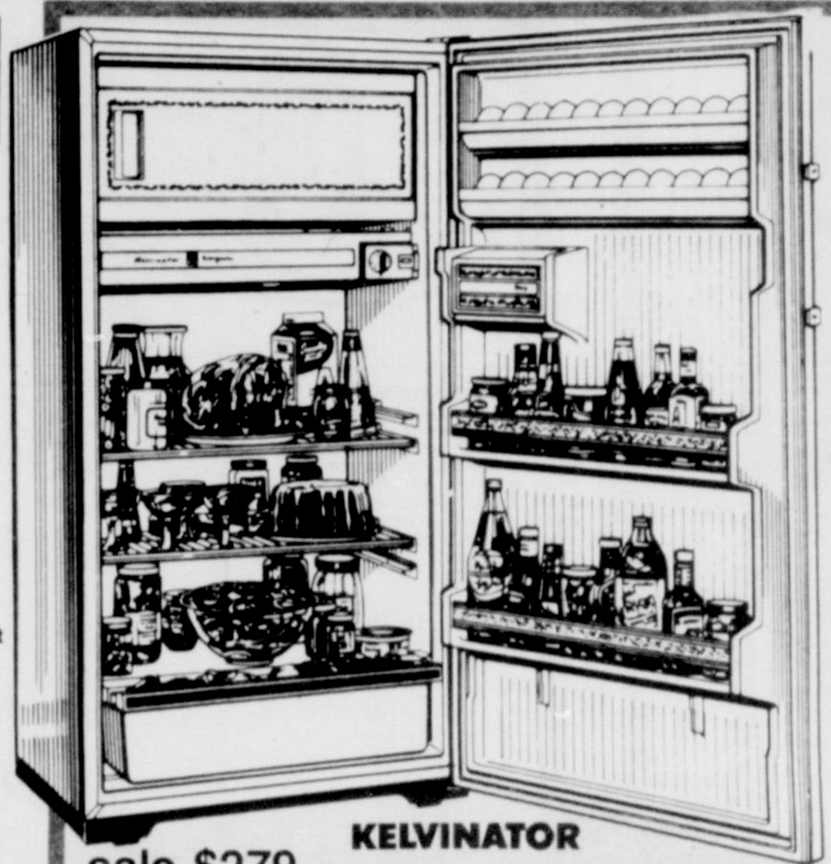

sale \$279

KELVINATOR

Kelvinator 13 cubic foot refrigerator features exclusive TRIMWALL construction that saves space, saves energy! Big 1.89 cubic foot freezer, two position sliding shelves, door storage and big slide-out crisper. Adjustable temperature control. It's only 28 inches wide! 130-100

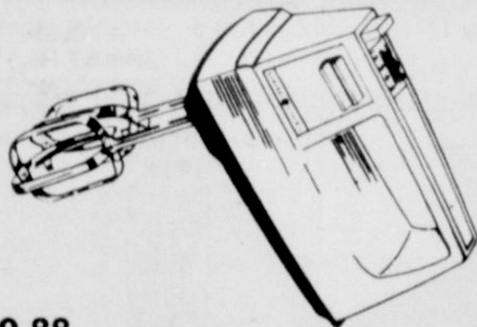

sale 9.88

G.E. 3 speed portable mixer with up front fingertip control. Powerful 130 watt motor. Beater ejectors. Detachable 6 ft. cord. White or avocado finish.

69-95, 100

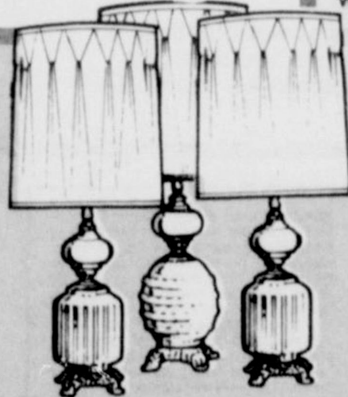

sale 19.88 ea.

Lamps and more lamps. Choose from two decorator styles in three colors: gold, white or green. 279-1500

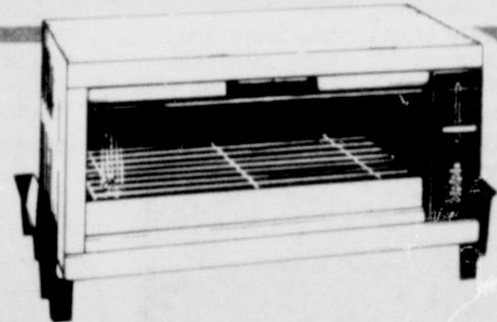

sale 32.88

Save 7.07 Reg. 39.95

Continuous cleaning baker-broiler cleans itself automatically during normal cooking! Big 10½" x 14½" x 4¾" cooking area. 3 rack positions. Adjustable thermostat has settings from 200 to 500 degrees. 69-165

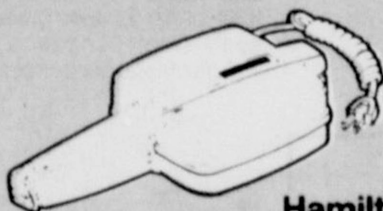

Hamilton Beach

Scovill

sale 12.97

Save 1.91 Reg. 14.88

Little Mac cooks both round hamburgers and square sandwiches in minutes. Easy to clean interior. Cover locks for spatter-free cooking. Grease tray. 69-174

MR. COFFEE™

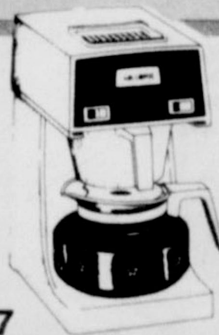

sale 27.97

Mr. Coffee I brews one to ten cups of "next to perfect" coffee at the touch of a button! So simple anyone can make great coffee every time! Equipped with warming plate and separate on/off switches for warmer and brewer. 69-59



sale 9.88

Save 3.09 Reg. 12.97

Crockery Chef 3½ quart slow cooker lets you prepare meals ahead of time! Slow cooking means extra flavor, juiciness and tenderness for meats and vegetables! Uses little electricity. Harvest or avocado finish. 69-200, 6

Whites has it! Lower prices. Here's proof!

sale \$35 each

Fenton "gyro" or "wyre/basket" custom racing wheels give your car the look of motion!

"Gyro": 1 piece cast aluminum, fully polished with deep dish design and extra deep slotted cooling vents. 15 x 7 size. Lug nuts and cap extra. 17-467,472

14 x 7 size. 29.88 17-465

"Wyre/basket": All steel chrome plated with recessed center and sporty, classic wire wheel styling. Sizes available: 14 x 6, 15 x 6,

15 x 7. 17-515, 520, 525

Both are precision aligned, guaranteed tubeless and feature Fenton "torque ring" construction for nuts that stay tight and studs that won't shear from the hub.

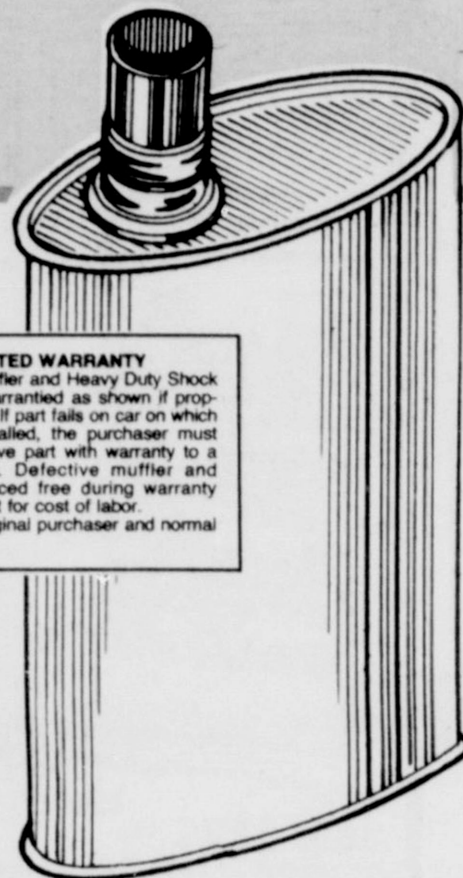

LIMITED WARRANTY

Magic 50 Muffler and Heavy Duty Shock Absorbers warranted as shown if properly installed. If part fails on car on which originally installed, the purchaser must return defective part with warranty to a White Store. Defective muffler and shocks replaced free during warranty period, except for cost of labor. Limited to original purchaser and normal use.

sale 4.99 ea.

Save \$2 each Reg. 6.99

Heavy duty shock absorbers are larger, stronger for a safe, sure ride.

Warranted for as long as you own your car. Sizes to fit most cars. Fast, low cost installation available. 25-402-676

sale 13.88

Save \$3 Reg. 16.88

Heavy duty mufflers so well built they're warranted for as long as you own your car! Fast, low cost installation available.

55-911-984

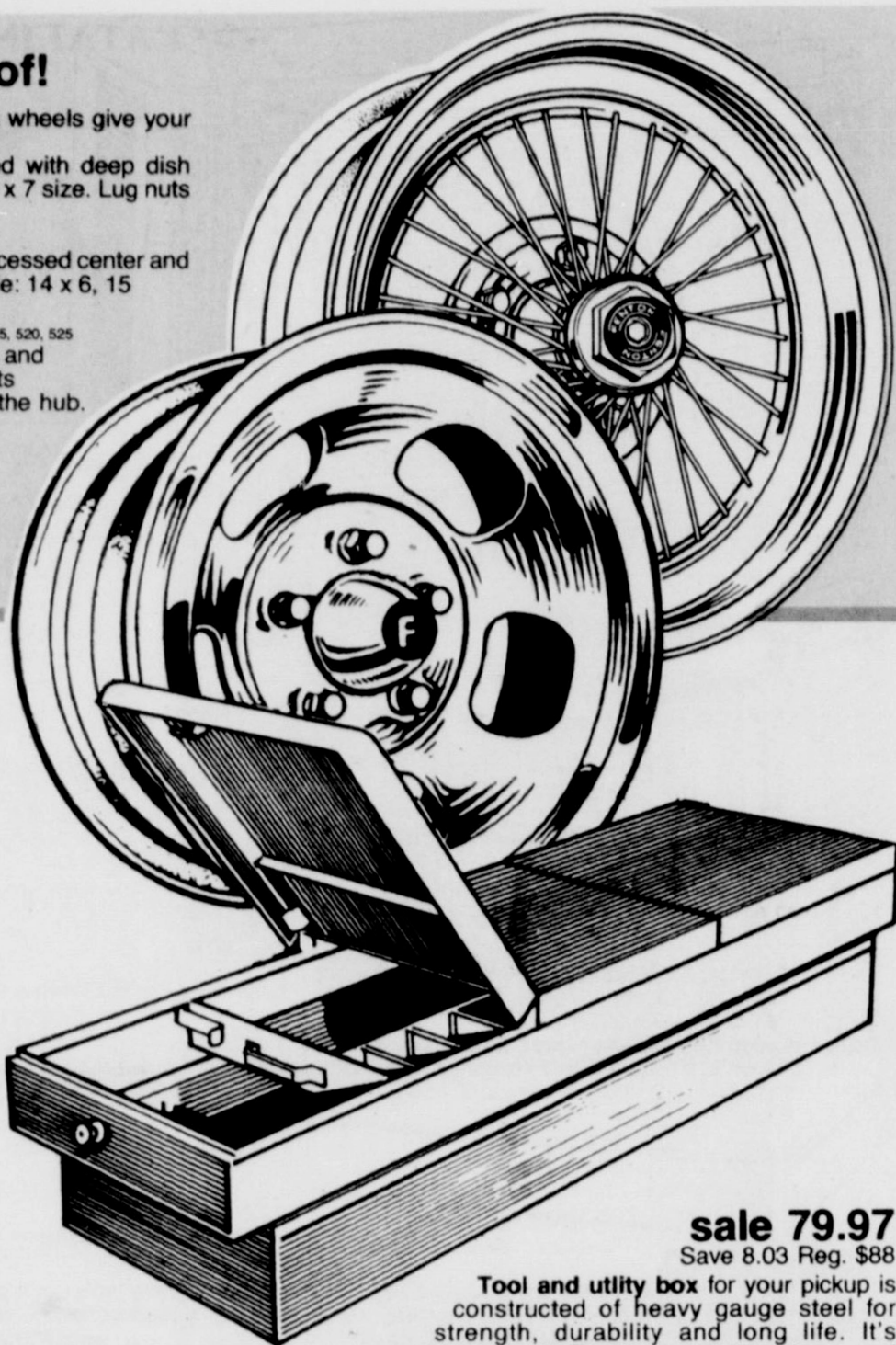

sale 79.97

Save 8.03 Reg. \$88

Tool and utility box for your pickup is constructed of heavy gauge steel for strength, durability and long life. It's weatherproof! Features sliding tray and push button lock. Measurements: 70 1/4" L by 20 3/4" W by 15 1/2" D. Whites has it . . . for your pickup. 10-250

Engine tuneup

19.88 6 cyl.

22.88 8 cyl.

(most cars)

Our experts install Zenith points, condenser & rotor plus your choice of popular plugs in stock; set timing & dwell; adjust carburetor. Cars w/ air cond. \$2. extra. Resistor plugs slightly higher.

Front end alignment

8.88 (most cars)

Our mechanics adjust caster, camber and toe, then road test. Result: Even tire wear and improved tire mileage, better steering control plus a smooth, vibration-free ride.

Lube job

1.88 (cars with zerks)

We lube your car, check all fluid levels, air filter, belts and hoses. Most U.S. cars.

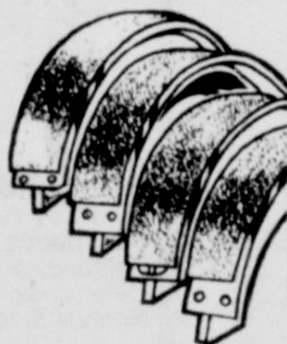

Bonded Lined Brake Shoes warranted as shown if properly installed. If part fails on car which originally installed, the purchaser must return defective part with warranty to a White Store. The steel section must not be damaged or worn within specified mileage. Defective brake shoes will be replaced, paying only for labor and pro rata share of mileage received, adjustment cost being determined on a basis of current regular selling price.

Limited to original purchaser and normal use.

sale 5.97 exch (set of 4)

Save over \$2 Reg. 7.98 exch.

Brake shoes. Bonded lined rebuilds for dependable stopping power! 32-026-450



sale 1.77

Zenith heavy duty ignition tuneup kit with matched ventilated points, rotor and condenser. A tuned engine saves gas! Sizes for most cars. 29-215-266



sale 1.17

WD40 spray lubricant — the space age miracle that loosens bolts, nuts; stops squeaks. Built-in rust inhibitor. 5-312



sale 77c

Fix-A-Flat tire sealant inflates and seals flat tires in seconds! Inflates to 25 lbs. pressure & seals small punctures. Carry a couple for emergencies. 5-160



sale 10.88 Your choice

Sundowner window classic sun screens in 6 popular designs.

Standard size 18" x 64", 1-1310-1322

Mirror film for rear van windows. Size 20" x 12 1/2". 1-3150

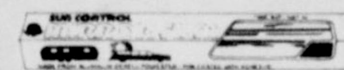



Save on our finest latex wall paint in 11 popular colors!

sale 6.66 gal.

Catalina premium interior latex wall paint is our finest quality! It's WASHABLE, SPOT RESISTANT, COLORFAST, LEAD FREE AND COVERS IN ONE EASY COAT! Use on most any surface with brush, roller or sprayer. Covers up to 450 sq. ft. per gallon and dries in only 30 minutes. Easy soap 'n water cleanup. 3-3012-32

Save on our best one-coat latex house paint!

sale 7.88 gal.

Catalina premium exterior latex house paint gives your home a bright new personality while it helps protect your most important investment! It's washable, lead free, non-chalking and mildew resistant. Dries in minutes. 3-3108-3122

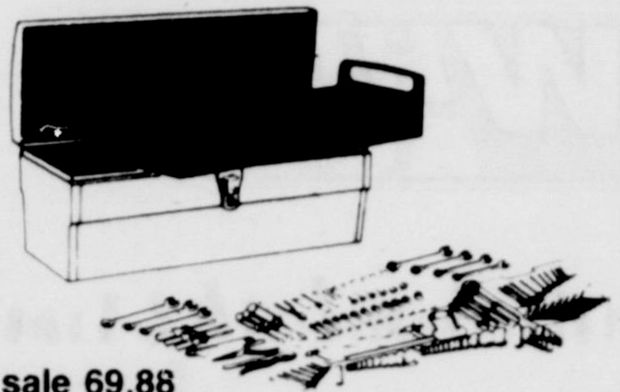

sale 69.88

Save \$10 Reg. 79.88

Deluxe 136 piece tool set has just what the home craftsman ordered . . . 1/3" & 1/2" drive, metric & S.A.E. sockets, ratchet, spark plug sockets, wrenches, pliers, screwdrivers, ignition wrenches, hex keys, hacksaw with blades. Packed in 19" steel tool box. A WHITES BEST BUY! 22-857

sale 9.99

Save \$2 Reg. 11.99

Black & Decker economical 1/4" electric drill with .20 HP motor develops 2500 RPM. Every home handyman has a hundred and one uses for it . . . and WHITES HAS IT! 23-6



sale 29.88

Save \$5 Reg. 34.88

G. E. Home Sentry smoke alarm protects your home and family from a sudden fire! Monitors the surrounding air continuously and sounds loud alarm if smoke appears. Test button and light. Plug into any wall socket. 14-4305

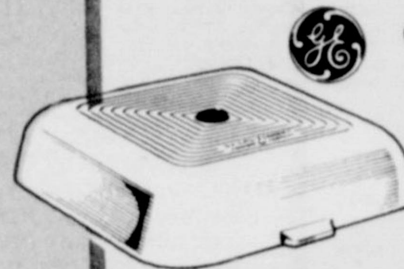

sale 8.77

Johnny Walker Big Fishin' Kit is great for beginning anglers! Just look inside! It has all you need to get started. 2 piece fiberglass rod, metal face spin cast reel with star drag, large tackle box, lures, hooks, sinkers, hook degorger plus the Johnny Walker fishing guide. 60-1003.

sale 12.88

Famous Lew's Bear Stick rods. Choose from a sensitive 5'6" or 6' unsanded medium action blank — both with 5 ceramic guides and tip top. Lew's pistol grip handle with gator grip. Own a winner! 60-876-878

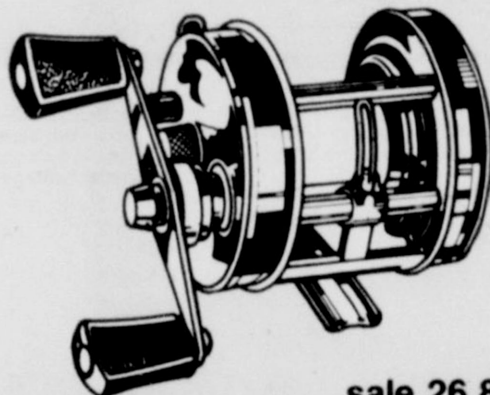

sale 26.88

Garcia 5000 D bait casting reel FOR THE PERFECTIONIST! Centrifugal and mechanical brakes team up for precise backlash control. Powerful star drag. 130 yard monofilament line. 60-146



sale 2.99 dozen

Golf balls by the dozen! Unique solid center construction makes them virtually cut-proof! 64-5045



sale 1.44

Official Little League baseball with tough horsehide cover. It flies through the air with the greatest of ease! 64-4690



sale 1.66

Pack 'o three yellow tennis balls that are hard hitting and long wearing! 64-4445



sale 13.88

Large fielder's glove with top grain cowhide leather construction features SNAP ACTION PREFORMED POCKET that makes catching a sure thing! 64-4788



sale 3.99

Lawn darts is fast-paced excitement for the whole family! Toss the dart, get it in the ring and rack up the points! Darts have safety blunted edges. 64-5320

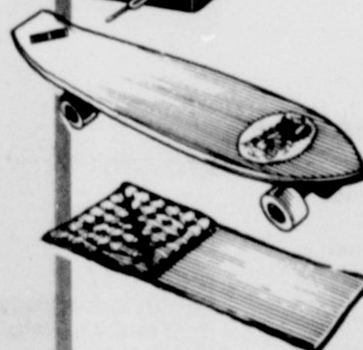

sale 13.89

Trick style skateboard with kick tail. Sturdy 24" polypropylene with 1 1/4" front and 2" rear wheels for maximum maneuverability! 64-4413

sale 8.77

Jr. size sleeping bag measures 34" x 64" — camron filled with navy blue rayon shell and 36" zipper. 64-6110

WHITES
AUTO

Think Summer Savings

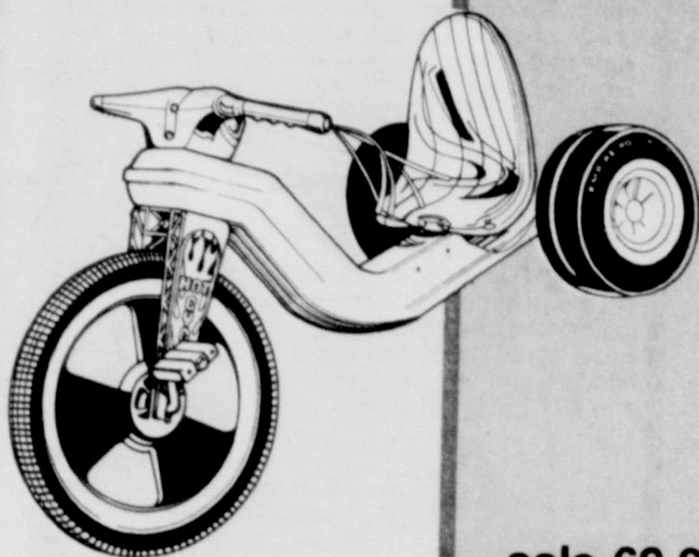
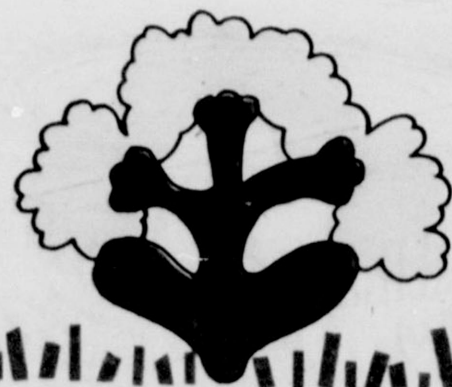

sale 14.99

Hot cycle is the screaming machine for action boys! Features 16" front wheel pedal drive, adjustable bucket seat, racing slick tires on rear! Even has motor noise and handlebar streamers! 65-201



GYM-DANDY.

sale 69.97 (in the carton)

Save 7.03 Reg. \$77

4 leg gym set by GYM DANDY. Give your youngsters hours of fresh air, sunshine and exercise on the "Gallop 'N Glide" horse ride, two swings, "Sky Skooter" for two and the 6½" attached platform slide. 2 inch tubular steel frame for strength & safety. Patented "five minute frame" assembles easily. 66-313

sale 49.97 (in the carton)

GYM DANDY 4-leg gym set with slide. 66-303

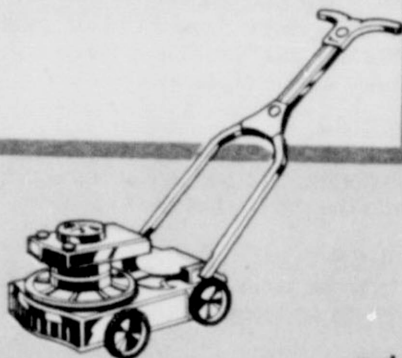
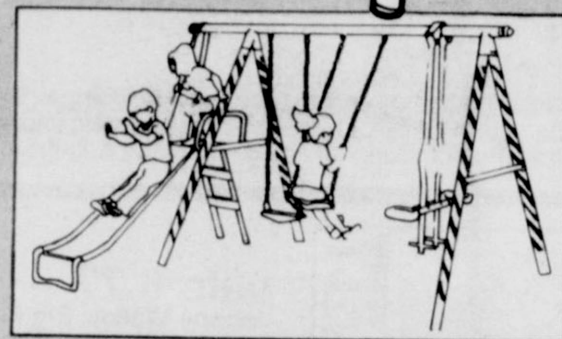

sale 1.97

Toy lawn mower that looks like Dad's! Sounds like Dad's! It does everything but cut grass! 66-20

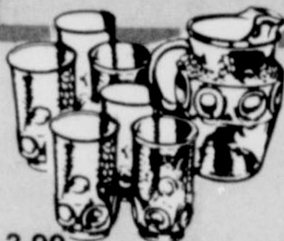

sale 3.99

Save 89c Reg. 4.88

7 pc. ice tea set has 6 king size 16 oz. tumblers and an 86 oz. pitcher. "Heritage Hill" designs in glass by Anchor Hocking. 70-716



sale 88c ea. Your choice

Swim mask with panoscopic shatter resistant lens or **snorkel** with soft molded mouthpiece.

66-150, 154



sale 77c

Trash bags. Big' strong 20 gallon size. Box of 10. 72-753



sale 66c

9½ inch play ball. Throw it! Catch it! Bounce it! 66-30

Whites Advertising Policy

Our every intention is to have all advertised items in stock and on our shelves. If, for any unforeseen reason, an advertised item is not available, Whites will cheerfully issue a RAIN CHECK on request for the merchandise at the sale price when it becomes available, or Whites will offer a comparable item at a similar reduction in price.

Dealer Opportunity

Want some straight facts about a great opportunity with Whites? We can help you own your own thriving Whites dealership! Call or visit the dealer who sent you this tabloid for more details.

Authorized Dealer Stores are independently owned and operated; therefore, prices and terms may vary. Also, due to limited floor space, all dealer operated stores may not carry all items featured in this tabloid.

HOME OWNED & OPERATED BY

Frank & Marlin Poynor
420 S. Avenue C
Portales, New Mexico
Limits do not apply in N.M.

POYNOR'S WHITE STORES

located in
Portales, N.M., Clovis, N.M.,
Muleshoe, TX., Littlefield, TX.,
Herford, TX., Friona, TX.

SUPPLEMENT TO:
THE MULESHOE JOURNAL
THE FRIONA STAR
THE PORTALES NEWS TRIBUNE



Kelly Cultured
BUTTER MILK
1/2 Gallon
Only **63¢**

PRICE BREAKER!

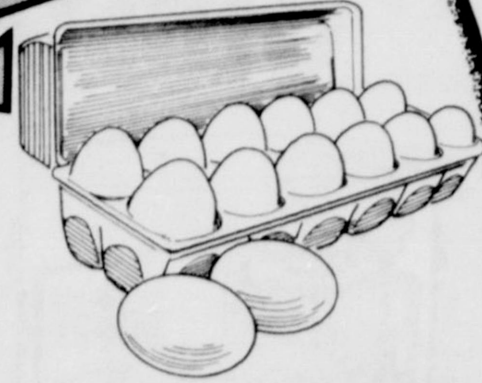

EGGS
Nest Fresh X-Large
63¢
Doz.

KERR MASON JARS

Quarts

\$2.39

Pints

\$2.19

Wide Mouth Quarts

\$2.69



GIBSON POTATO CHIPS

Regular, Ripple
or B-B-Que

Only **59¢** Bag



SHELL NO PEST STRIP

Only **\$1.49**



LYSOL SPRAY DISINFECTANT

14 oz. Aerosol Only **\$1.39**

Inflation busters!

TIDE DETERGENT

Family Size

Only

\$3.99

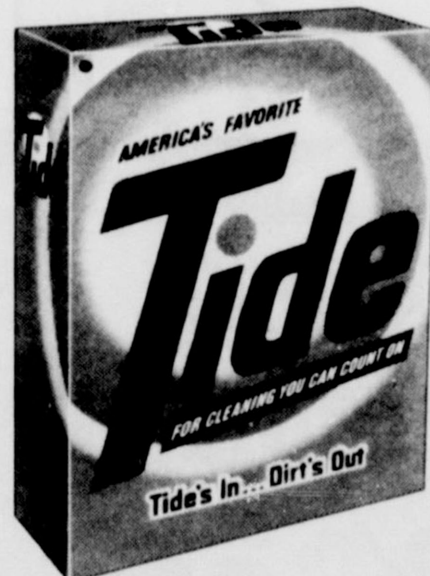

Lysol
BRAND DISINFECTANT
DEODORIZING CLEANER
28 oz. Bottle
Only **99¢**



KLEENEX PAPER TOWELS
Jumbo Roll

Only

53¢

SALE PRICES GOOD
IN DIMMITT FROM MAY 18 TO MAY 25
IN FRIONA FROM MAY 14 TO MAY 21

Inflation busters!

GIBSON VINYL LATEX PAINT



Interior - Exterior

2 Gallon Pail
White Only **\$9⁹⁷**

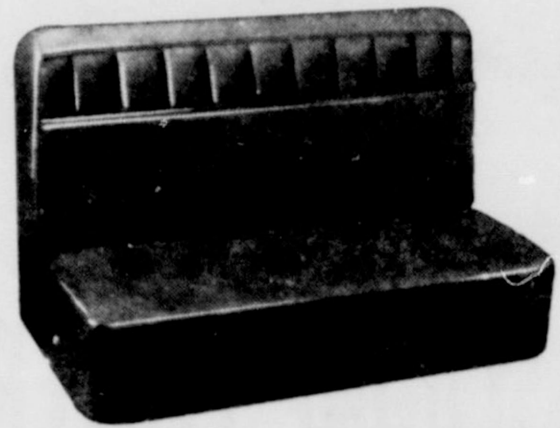

GIBSON CAMP FUEL

1 Gallon
Only **\$1²⁹**



SEA
& C
Now

P
HA
Unbreak
Bou
pkg.
7

ELECTRIC ICE CREAM FREEZER

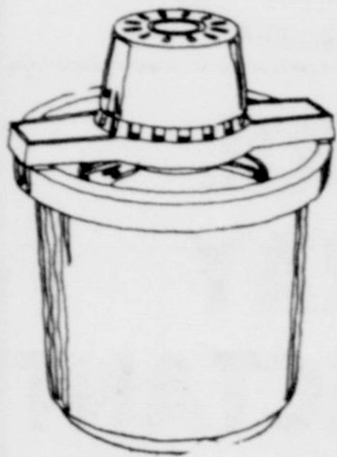

4 Quart
Model 71
Only **\$13⁹⁷**



LAWN CHAIRS

Webbed
Now **\$4⁹⁷**

CHAISE LOUNGE

Webbed
Now **\$9⁹⁷**



Gotham St
ICE CR
30 Qu

Now **\$1**

PRICE BREAKER!

Grills 2
Hamburgers

NORELCO BURGER COOKER

Only
\$21⁹⁷



Entire Stock
FEDERAL AMMUNITION

1/4 Off
G.D.P.

Proen Round Spray SPRINKLER

Model 220

\$1⁴⁹

SAVE MORE

Air Conditioner

PADS

All Sizes
Now **\$1⁰⁹**

FISHING EQUIPMENT

20% off

Includes Rods, Reels & Lures



20 g

Automobile

HEAT COVERS & CUSHIONS

20% OFF
G.D.P.

PLASTIC HANGERS

Breakable - No Slip Bar

Boutique
pkg. of 6

Drip Dry
pkg. of 8

79¢ 53¢



Entire Line Of
COPPERTONE SUNTAN PRODUCTS

20% OFF

Our
Everyday
Low Price



Miss Breck

HAIR SPRAY

11 oz. Aerosol

93¢



STAYFREE MAXI-PADS

Box of 30

Only **\$1.79**



Ham Styrofoam

CHEST

30 Quart

\$1.39

OUTDOOR EXTENSION CORD

16 Gauge 3 Wire 30 ft.

Only

\$4.79

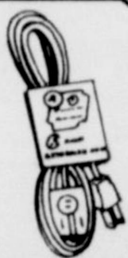

Big Girl

GIBSON PANTY HOSE

No. 499

Only

73¢



Air Conditioner

WATER PUMPS

No. BL218

Only **\$6.97**



INFLATED BALLS

Assorted Sizes & Colors

Only

79¢



PRICE BREAKER!

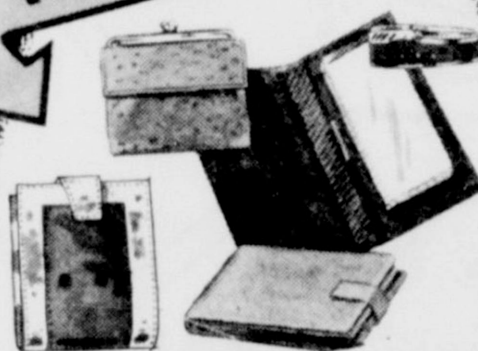

Entire Stock Men & Women

BILFOLDS & WALLETS

20%

OFF
G.D.P.

GIFTS FOR
THE GRAD!

LAWN MOWER REPLACEMENT BLADES

20 or 22 Inch Cut

Only

\$2.59

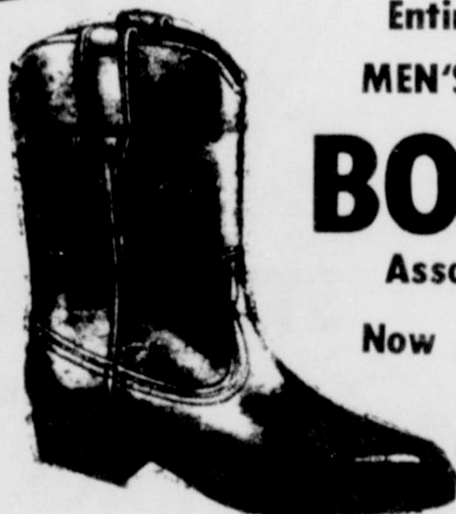

Entire Stock

MEN'S & BOY'S

BOOTS

Assorted Styles

Now

20%

OFF G.D.P.

Inflation busters!

POLAROID PRONTO

Pictures Develop Before
Your Eyes In Only Minutes

Only **\$29⁹⁷**



*Special Gifts for
Special Grads...*

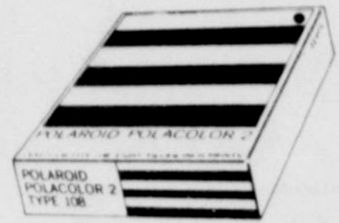

**POLAROID TYPE 108
COLOR FILM**

Only **\$4⁴⁹**

**KODAK INSTAMATIC X-15
CAMERA OUTFIT**



Includes 1 Flip Flash
& 1 Roll Film

Only **\$17⁹⁷**



**KODAK EK 6
INSTANT PRINT
CAMERA**

Only **\$53⁷⁷**

WESTCLOX ELECTRIC ALARM CLOCK

No. 22131

Only **\$3⁹⁹**

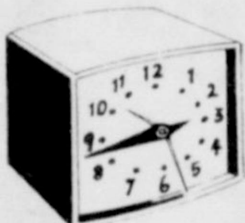

GIFTS FOR
THE GRAD!

**SAVE
MORE**



Kodak Kodacolor II
126 FILM
For Color Prints
20 Exposures

\$1³⁹



Kodak Kodacolor II
110 FILM
For Color Prints
20 Exposures

\$1³⁹

**SAVE
MORE**

Choose From Top Hits
By Leading Artists

Reg. \$5⁴⁷ Now **\$4⁴⁹**

STEREO ALBUMS

Reg. \$6⁷⁷ Now **\$5⁴⁹**

8-TRACK TAPES



Entire Stock
**WOMEN'S
COLOGNES & PERFUMES
MEN'S AFTERSHAVES
& COLOGNES**

15% off