

The FRIONA STAR

VOLUME 52, NUMBER 23

SUNDAY, MARCH 13, 1977

15 CENTS

14 PAGES PLUS SUPPLEMENT



Star Lites By Bill Ellis

LAST SATURDAY'S experiment by President Ford in visiting by telephone by some 42 folks in a two-hour session broadcast on CBS radio was a bold venture by the new president. Perhaps it helped to reinforce Carter's image as a "people's president."

The president was asked a good many questions by the callers that he hears in press conferences, plus several that weren't among the most asked.

+++
THOSE WHO HEARD the broadcast may recall that when the program was kicked off, technical difficulties were encountered in broadcasting with the elaborate telephone equipment that had been installed. That must have been an embarrassment to the telephone company.

+++
A caller from Wisconsin asked the president: "As the wife of a dairy farmer, what can be done about improving the public relations between the consuming public and the U.S. Agriculture Department in regard to the price increases for farm commodities and an explanation to the public that we as farmers receive only a small amount of these widely acclaimed increases?"

Carter's reply was that by putting a farmer into the White House, and an actual dirt farmer in as Agriculture secretary, two steps to solve the problem had been taken. Then, he said the American public needs to be told the truth about agriculture and the farm and ranch families of the nation, as to how to have a stable farm economy with predictable production and prices that don't fluctuate wildly.

A 13-year-old caller, John Herald of California, asked the president: "Why not ship from the East to the drought-stricken West?"

Carter replied "I think somebody found that it would be too expensive to ship snow to the West. I believe that in the future we're going to have to start worrying about water conservation as well as energy conservation."

Mrs. Esther Thomas of Pennsylvania asked the president "How can we as middle class earners expect legislation or reforms that would remove tax loopholes the rich use as deductions when all the legislation is made by the rich? There are no poor people, no lower-class wage earners in either the house or the senate."

Mrs. Richard Nicholson of Fort Worth told the president "I feel that you are violating the states' rights when you call in to the different states and lobby for the ERA (Equal Rights Amendment). I was wondering if you don't think that this should be left up to the individual state legislators?"

Carter said "Well, I think you probably have noticed that the final decision is with the state legislators, and although I have made a few telephone calls since I've been in office and have talked to some personally and to some governors about the passage of ERA. I haven't tried to interfere or put pressure on them. When I ran for president, I made it clear that I was in favor of the Equal Rights Amendment passing and still am in favor of it and hope it does pass. I reserve the right to express my opinion just like you have a right to express yours."

Phyllis Rodgers of Albuquerque, N.M. asked "We are very concerned about the solar energy program here in the state of New Mexico, and we're hoping it will go through for us."

Carter replied that he would like to see the research and development programs decided on a merit basis, but said New Mexico has a head start on many places around the country due to their long history of research and development and the state's climate.

STORE HAS BREAK-IN

A break-in was reported at Foster's Dry Goods on Thursday night, March 3. Taken were a pair of shoes, three shirts and some change from the cash register. Friona Chief of Police said that the burglar left some prints, and the investigation into the robbery was continuing.

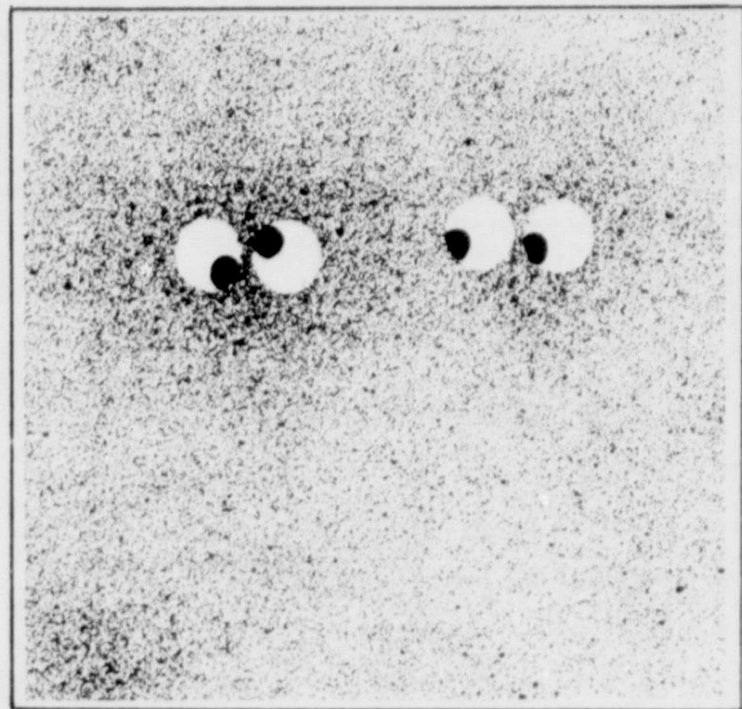

Can This Be Spring?

WHAT A DIFFERENCE a day can make, as evidenced by the two photographs above. The photo at

left, made Thursday morning, shows a fruit tree in full bloom, as the temperature had hit a blamy 75

degrees the day before. At the right, just across the street and less than 24 hours later, shrubs and lawns took

on the appearance of winter as an inch of snow fell in the early morning hours on Friday. Then for

the rest of Friday, the weather turned back to the "Dust Bowl Days."

AS OF APRIL 1

City To Assume Ambulance Duties

The Friona City Council voted this week for the city to take over the ambulance service for Parmer County effective April 1, 1977. Effective that date, Parsons-Ellis, which has operated the service in the past, will relinquish all ambulance calls to the city.

The decision came after some months of planning a change in the ambulance setup, and after a lengthy discussion on the ambulance service at the council meeting Monday night.

"Someone has to run an ambulance, and Percy (Parsons) has said he doesn't want it anymore. Private enterprise is fast fading away, and the taxpayers are having to provide more and more of their own services," said Mayor R.L. Fleming during the discussion.

Other discussion centered around the need for making the change "one of permanence," and the possible problems which would be posed through providing a volunteer assistant.

Under the city's proposal, the ambulance operator will be a full-time paid employee, with an assistant coming from a group of people who are taking a special emergency medical course to better equip them to help with an ambulance call.

Also discussed was the possible need of a second ambulance for use when multiple calls are received and the main vehicle is in use. The fire department owns a station wagon which council members felt could be

equipped so as to qualify as a "backup" ambulance.

The city recently received a van-type ambulance in a cost-share arrangement through the Panhandle Regional Planning Commission. The ambulance can transport two patients at once if necessary.

In other business, the council heard a proposal from the Ebling Manufacturing Company of Plainview to equip the city with solid steel trash boxes for the residential and business district, and a loader truck which would service the boxes.

The council felt that the program, although a costly one, would be an improvement for the city's trash disposal system, which uses 55-gallon drums and requires two men emptying the barrels and another to drive the truck.

The company is to study the city's requirements and come back with a solid proposal at the next council meeting.

The council was given the retirement notice of City Judge Thelma Jones, and the proposal to separate the job of city judge and dispatcher.

As Mrs. Jones had agreed to continue to work one day per week providing the dispatching duties were relieved, the council voted to offer the position back to her on that basis.

Insurance coverage for the city's new ambulance was assured by approval of a bid of \$1,193 per year from Ethridge-Spring Agency.

A resolution was passed okaying the city's participation in the PRPC's new Criminal Justice teletype system, at a cost of \$1,516 the first year and \$1260 per year thereafter. The system will modernize the city's present communications capabilities, according to Police Chief Bill Denney.

Miscellaneous business included noting the monthly adjustment by Pioneer Natural Gas Company of the city's key rate, which will increase 4.41 cents per MCF to the city.

Parsons, representing the Prairie Acres board, reported that the nursing facility currently has 30 residents, and the board feels that 36 would be a break-even point financially. "We could take care of six additional residents with very little more expense to the home than we have in caring for 30," Parsons explained.

City Manager Jake Outland revealed that the drawing for ballot position for the city council election placed the order thusly: Patrick Pace, Jerry Brown, Beth Thompson and Haywood Vaughn.



COWBOY TURNS OCULARIST.... When Joe Bill Jones, formerly of Friona, is not buying cattle with his dad, Bob Jones of Friona, he is

making artificial eyes. Joe Bill is shown painting an acrylic eye. Approximately eight hours are spent painting the eye.

Absentee Vote Starts Monday

Absentee voting for two local elections will begin on Monday, March 14.

Special voting in the city council race will be conducted at the City Hall through March 29. Absentee votes in the school board will be held at Superintendent Tom Jarboe's office.

Voting in the elections will take place on Saturday, April 2. Voters who feel they will be absent on election day may make provisions for casting an absentee ballot.

Temperatures

Date	Hi-Low
Saturday, March 5	47-20
Sunday, March 6	40-20
Monday, March 7	55-27
Tuesday, March 8	70-28
Wednesday, March 9	75-41
Thursday, March 10	71-41
Friday, March 11	85-30

Moisture: .021inch, 1 1/2 inch snow and dust on Friday, March 11.

When Joe Bill Jones is not out buying cattle with his Dad, he is the only man in West Texas and one of a very few in the state making custom fitted artificial eyes.

"My Father is a cattle buyer and I lived on a farm outside of Friona, Texas all my life until I went off to college and became an Ocularist."

He is the son of Mr. and Mrs. Bob Jones of Friona.

An Ocularist is trained to fit and fabricate artificial eyes, and Joe Bill Jones, 25, spends approximately two and one half days fitting and making each of his patient's prosthesis (artificial body part).

"I used the Modified Impression Method of fitting artificial eyes," Jones said. "I take an impression of the eye socket, from which I make a wax pattern. The wax pattern is smoothed down and the iris-cornea piece is added."

"I work with the wax pattern until it is shaped to match the companion eye and lids. I then make another mold from the finished wax pattern. When the mold is completed, it is

opened and the wax pattern removed. The iris-cornea piece is then removed from the wax pattern and placed into the mold. Then, white acrylic is packed into the mold and cured for forty minutes. Curing is a process which hardens the plastic."

The acrylic eye is now ready to be painted. Jones spends approximately eight hours painting the eye. He uses the primary colors—yellow, red and blue, manipulated with black and white, mixing the necessary color to match the patient's natural eye.

"I work toward painting the artificial eye exactly like its mate. I intentionally put in a little difference only to make the eye look more natural, since everyone's eyes are a little different."

Jones used red commercial embroidery floss for the veins. Each strand is separately applied and varnished. All of the eye parts are put back into the mold and allowed to cure for an hour and forty minutes. "I pumice and polish the

eye, then hope for the best," Jones said.

The Modified Impression Method Ocularists use to fit artificial eyes is a great improvement psychologically and aesthetically over stock eyes. Stock eyes are prostheses some opticians pick from a drawer to match as closely as possible to the patient's real eye, making it difficult to maintain anything resembling natural color or position.

Jones is unique because he is only one of a few in Texas utilizing the Iowa Implant, which provides 70 per cent total eye movement. It utilizes the muscles to move the prosthesis with the companion eye by attaching the eye muscles over the implant grooves. More common to Texas is the Spherical Ball Implant which allows only about 45 per cent movement.

"The Iowa Implant is a quasi-integrated buried muscle cone implant which is surgically connected to eye muscle. It has four rounded mounds on the front surface of the implant, which "key" into

corresponding depressions in the back of the plastic prosthesis to support the prosthesis against gravitational pull and pressure from the upper lid. The lids, predominantly the upper, hold the prosthesis against the mounds.

While persons of all age groups benefit, several of the advantages are especially notable in elderly persons in whom lack of tissue tonus (muscle strength) is more common. When such person with the new implant are fitted with prostheses based upon correctly taken impressions, the prostheses are supported to fit all spaces well. This results in healthier sockets, requiring little attention from the patients or their physicians.

Jones studied concentrated arts at the University of Houston before entering the University of Iowa Hospitals and Clinics Department of Ophthalmology. At the University of Iowa he had thorough, specialized training in preoperative and post-operative anatomy of the eye

(Continued on Page 2)

Former Friona Boy Has Unusual Vocation

Friona Flashbacks

...from the files of The Friona Star

25 YEARS AGO—MARCH 13, 1952

Janice Miller, 12, Parmer County representative in the spelling bee held in Amarillo last Saturday, competed with students from 41 counties in a contest that sent the winner on an all-expense paid trip to Washington. She didn't win the contest, but says it was a valuable experience. She is the daughter of Mr. and Mrs. Roy V. Miller.

30 YEARS AGO—FEB. 28, 1957
"Wonderful" was the word J.C. Claborn used to describe the response from Friona businessmen to the door-to-door drive for membership in and support of the Friona Chamber of Commerce, started this week. A cooperative drive of the committees on finance and membership was launched about the middle of the week, after members of the groups got their heads together and decided it would be the best thing to do.

15 YEARS AGO—MARCH 1, 1962
The "Wheels of Justice" ground out a 40-year sentence to the penitentiary for the admitted murderer of Jesse Dawkins, Bovina, this week. Trial of Hershel Gene Davis, 36, Bovina, alias George Evans, began Monday morning for the murder of Dawkins, 26, on Dec. 8 with the arraignment of Davis before District Judge E.A. Bills in Farwell. It concluded Tuesday at 5 p.m. when the jury returned after one hour and ten minutes deliberation.

Revision in the structure of basic rates governing fire insurance written in Friona has resulted in a considerable improvement that will save policy-holders money. The basic or key rate of Friona will now be affected by a five per cent experience credit, as compared with a 15 per cent penalty that was applied last year.



STORY HOUR...A good crowd of youngsters is shown at the story hour program hosted by Friona Public Library on Thursday. Jo Ann Balze, shown in the center, conducted the session.

10 YEARS AGO—MARCH 2, 1967

Joint funeral services for Mr. and Mrs. Pat Busby were conducted Tuesday at the First Baptist Church of Friona. Mr. and Mrs. Busby were killed instantly in a head-on automobile collision last Friday night near Summerfield. The Busbys were traveling west on U.S. Highway 60 when they encountered the car driven by Jimmy Vasques Flores, 23, of Hereford. Highway Patrolman Ronnie Rainey, who investigated the accident, said the car driven by Flores was apparently on the wrong side of the road, going east. It is thought that Flores pulled out to pass a truck.

5 YEARS AGO—MARCH 9, 1972
Irrigation gas users are clinging to the hope that the Price Commission may reverse the gas price increase announced in December by Pioneer Natural Gas Company. Members of the Parmer County Gas Users Association heard a report on the matter at their annual meeting last Thursday at Hub from John Aiken of Hereford, attorney for the Plains Gas Users Assn.

Young Farmers Set Meeting

The Parmer County Young Farmers will meet Monday, at 8 p.m. at the Ag Building at Bovina High School. Gothard, Inc. of Canutillo, a company that specializes in a biological insect control with trichogramma will present a program. The insect control works well in corn and cotton, it was reported. All farmers are urged to attend.



GUESTS...Among those attending the open house hosted by Byron Hardgrove at his new office last weekend were Jane Stephens of

Friona and Jerry Graham, CLU, district manager of the Gaschen Agency of Lubbock. Hardgrove is shown seated at his desk.

Church Sets Film Showing

The hard hitting film, "The Coming Invasion of Israel," deals with today's headlines from the Middle East. Using the Bible as its authority, in Daniel II and Ezekiel 36-39th Chapters, it reviews and reveals God's plan for Israel as that nation faces grave crises in the months to come.

One of the phenomena which characterizes the modern world is the rapid rise of Russia to the place of one of the great nations of the world. Today, unquestionably, Russia is one of the great military and political powers of all history. What does the Bible say about this great power? How does this nation fit in God's plan? These and other questions are dealt with in this unusual film which will be presented at the Calvary Baptist Church, March 13 at 6 p.m.

Sales Begin For Sports Fete Here

Tickets went on sale this week for the annual Friona High School All-Sports banquet, to be held Tuesday, March 22 at 7:30 p.m. at the Community Center.

Former star runningback for the Dallas Cowboys, Dan Reeves, will be the speaker for the banquet.

Tickets are selling for \$6.00 each. Included will be a steak dinner catered by K-Bob's Steakhouse. Tickets are available at Bi-Wize Drug and Carrol's.

Peggy Monroe and Donna Mears are in charge of ticket sales to homes and businesses. They may be called for tickets. Mrs. Monroe's number is 247-3028. Mrs. Mears may be reached at 247-3456. Tickets will not be sold at the door.

Bovina Man Named SCS "Farmer Of The Year"

The Parmer County Soil and Water Conservation District has selected Troy Christian as the conservation farmer of the year.

Troy and Lillie, with their three children, live on their farm six miles south of Bovina. Troy farms seven quarters of land, each with a center pivot sprinkler. By farming corn under the sprinklers and cotton in the corners he is able to get the most efficient land use. Troy has been cooperating with the Parmer County SWCD as long as he can remember.

Present methods of conservation farming are an every day thing with Troy. It hasn't always been that way. He has pioneered water, soil and energy conservation in his community.

Troy put in one of the first center pivot sprinklers in his community. This has led to a number of conservation practices. Troy said he was spending a good bit of his tractor time getting furrows ready to receive the irrigation water. He has conserved both time and energy by cutting out this costly operation.

Troy does not use a deep bed. He has found out that he has less erosion with a shallow bed.

By going sprinkler he is able to trash farm. He said that he cannot go "No Till" because it is necessary to "bust out" stalks for insect control.

The minimum tillage Troy practices provides an insulation on the soil reducing the moisture loss through evaporation. The trash reduces wind erosion to zero. By leaving the trash on the surface, Troy has improved the water penetration from his sprinklers. He said water penetration wasn't much of a problem on his sandier soils, but



CHRISTIAN NAMED...Troy Christian of Bovina has been named the Parmer County conservation farm-

er of the year. He farms seven quarters of land, each with a center pivot sprinkler.

his clay loam soils were a problem until he had built up his trash cover. The kind of farming Troy is doing now has maintained his production. He is now shooting for optimum production because it is more economical than maximum production.

Another thing Troy is doing, in fact, the day he was visited, is modifying his equipment so he can do a more economical job of trash farming. By saving time, labor, fuel, water, and soil, Troy is doing a complete job of conservation farming.

Four Certify As Assistants

Four residents of Friona have completed a 72-hour certification course qualifying them as "reserve officers," for special duty in assisting the Friona Police Department.

The four are Joe Reeve, Keith Winkler, Joe Flores and Nick Hand.

LL Directors Make Plans For Season

Friona's Little League board of directors met this week to discuss plans for the 1977 season.

A new team will be fielded for 1977, called Senior Babe Ruth League. Friona will compete against Littlefield, Morton, Sudan, Dimmitt, Olton and Anton. Bovina youngsters will join those from Friona in making up a local team.

Friona Boy ...

(Continued from Page 1)

and orbit dealing in the field of ophthalmic prosthetics and implants. Certain knowledge of optics, ophthalmic devices, and especially cosmetic optics was also attained during this training. A complete understanding and utilization of these principles must be realized by the ocularist to render the ultimate illusion.

Jones holds an Associate of Arts Degree from Tarrant County Junior College. "I thought I would be an optician, but I was also interested in art, so I decided to put my two interests together and become an Ocularist." Jones is currently at the Texas Tech University School of Medicine in Lubbock where he has been since September, 1976.

"I still try to go to cattle sales with my Dad whenever I can," Jones said, "but my profession as an Ocularist takes up most of my cattle-buying time."

First game for the Senior Babe Ruth League team will be May 6 at Littlefield.

Some 200 youngsters are expected to take part in the local program this summer.

"We appreciate everyone that is giving of their time and money, or helping in any way with our baseball program. And I know that all of the young boys and girls appreciate it," said Carl White, LL board president.

Those attending this week's meeting were Ron Bost, Carrol Gatlin, Virginia Moyer, Gale Warren, Frankie Allen, Ray Dean Fleming, Beamon McDonald, Rick Luther, Jerry Loflin, Bill Scott, Olivia Ortiz, Kenneth Cary of Bovina, Carl White and James Ball.

Another meeting has been called for March 22 at 7:30 p.m. at Friona State Bank's Community Room.

The Friona Star

Published Every Sunday at 916 Main Street Friona, Texas 79035

Second class postage paid at Friona, Texas 79035

SUBSCRIPTION RATES Parmer County, adjoining counties, \$6.30 per year. Elsewhere, \$7.87 per year.

Bill Ellis, Editor & Publisher
Laura Coffey, Bookkeeper
Vickie Copley, Back-Shop Foreman

Lois Norwood Says . . .

HOOT, MON!

When it comes to your money . . . Take a tip from us and trust your insurance problems to the best! Our quality insurance shows up when trouble comes. Come in and let us look at your present policies. We are qualified to give you expert advice on any insurance problem — and we can probably save you money!

Ethridge-Spring Agency Inc.



On the Way to the Top ...

He May Need A Helping Hand

Now, he's taking a step at a time. Later, his hopes will be climbing . . . maybe for a higher education. Be there to back him up with financial assistance. Let us help invest your money in our savings accounts and certificates.



PEOPLE COME FIRST



FRIONA STATE BANK

Black Study Club Tours Prairie Acres

The Black Study Club met Thursday, March 3 for their regular meeting.

Members toured Prairie Acres and then went to the home of the hostess, Mrs. Hannah Lookingbill.

Roll call was answered with "What I Do On A Windy Day." A short business meeting was held.

Guests were Mrs. Kathy Hardin and April; Mrs. Mona Carr and Rikki De'Lyn of Earth, Texas; Mrs. Carmen Rape and daughters, Amy and Kerie, and Cory Hamilton.

Members present were Mrs. Harry Lookingbill, Mrs. Cliff Allmon, Mrs. Ethel Bengler, Mrs. Bill Carthel, Mrs. Helen Fangman, Mrs. Glyn Hamilton, Mrs. T.J. Presley, Mrs. Travis Stone, Mrs. Tommy Tatum, Mrs. Lois Weatherly, Mrs. Gene Welch and Mrs. Roscie Ivie.

The next meeting will be held March 17 in the home of Mrs. Tommy Tatum.

Friona Team Takes First In Tourney

Carroll Land Company wins first place at the Umbarger volleyball tournament last weekend.

To win the first place trophy they played a team from Wildorado, Umbarger and Hereford.

Players were: Betty Lessert, Dian Anthony, Theresa Buck, Sharon Rector, Lucinda Aguirre, Pat Wright and Terri Giddens.

WINNER...Marcelano Escalante, who was high point man for the Friona seventh graders in their opening track meet last Saturday, is shown winning his heat of the 40-yard dash at Boys Ranch. The youngster's performance was good for second, as teammate Robert Caballero won the event.

PLAYERS: Betty Lessert, Dian Anthony, Theresa Buck, Sharon Rector, Lucinda Aguirre, Pat Wright and Terri Giddens.



WINNER...Marcelano Escalante, who was high point man for the Friona seventh graders in their opening track meet last Saturday, is shown winning his heat of the 40-yard dash at Boys Ranch. The youngster's performance was good for second, as teammate Robert Caballero won the event.

CLEARANCE SALE!!!

3 bdrm, 2 bath, 14x75 fully furnished...
Was.....\$13,199.20
Now.....\$11,996.44
SAVE.....\$1,202.76

2 bdrm, 1 bath, 14x64 fully furnished...
Was.....\$11,365.90
Now.....\$10,385.14
SAVE.....\$980.76

V.A. - F.H.A. - Bank Financing

PLAINS MOBILE HOMES
3017 Dimmitt Hwy
Plainview, Texas 79072
(806) 293 4346

CASH SALE



SAVE \$2400!

Save up to \$2,400 by purchasing a grain drier right now! Here's what you can save on each DriAll model:

SAVE	ON MODEL	BU/HR CAPACITY
\$2,400	A-28	1,200
1,600	A-20	850
1,200	P-20	575
950	P-16	450
800	A-8	375

These low pre-season prices make DriAll grain driers even more profitable. Farmers have found that the continuous flow DriAlls are real labor and fuel savers. If you plan to buy a grain drier before fall you should check with your DriAll dealer now!

Parmer Co. Implement Co.

WILSON'S HICKORY

Smoked Picnics

6-8 LB. AVG. FULLY COOKED

WATER ADDED

SLICED HALF OR WHOLE 69¢

59¢ LB.

WITH PURCHASE OF ONE 2 LB. BAG TASTE WRIGHT PORK SAUSAGE FREE ONE CAN OF SHURFRESH BISCUITS

81% EXTRA LEAN Ground Beef 99¢ LB.

WILSON'S SMOKED Pork Chops \$1.59 LB.

Slab Bacon \$1.19 LB.
LITTLE BOY BEAN 89¢ 12 OZ. PKG.
Corn Dogs 89¢ 1 LB. PKG.
Burritos 99¢ 1 LB. PKG.
TAMA MAMA CHICKEN FRIED Beef Fritters \$1.59 1 LB. PKG.
WELLSVILLE RED BIRD LOGGERS Cheese \$1.19 1 LB.
FROZEN FRESH THERMATEL Fish Fillet \$1.19 1 LB.

PRESENTING "Top Quality Savings!"



SHENSON'S FINEST QUALITY OLD FASHIONED

Corned Beef Brisket

\$1.39 LB.

GLADIOLA FLOUR

GLADIOLA FLOUR

GLADIOLA FLOUR 5 LB. 69¢



WILSON'S CERTIFIED

Vienna Sausage

2 69¢ 5 OZ. CANS

DETERGENT

Cheer

GIANT SIZE BOX \$1.29

PURE VEGETABLE

Wesson Oil

1 1/2 QT. BTL. \$1.59

LADY SCOTT

Facial Tissue

2 \$1.00 200 CT. BOXES

HUNT'S Ketchup 32 OZ. BTL. 89¢

START YOUR SET TODAY!

Imported GOURMET PORCELAIN-CLAD STEEL COOKWARE

UNIT-OF-THE-WEEK OFFER:

8" skillet, 300 order cook. Does the morning eggs and bacon like a pro. Also skilled at sauteing and gently broiling.

UNIT OF THE WEEK \$5.99* SPECIAL PRICE with each \$5 purchase

BAMA GRAPE JELLY 18 OZ. JAR 69¢

JOHNSTON'S FROZEN PUMPKIN PIES 36 OZ. \$1.49

Big Top Produce Values

CALIFORNIA

Crisp Carrots

1 LB. CELLO PKG. 29¢

CALIFORNIA FUERTE Avocados 5/\$1.00

TEXAS PINK GRAPEFRUIT LB. 19¢

Circus Parade Of Values

BORDEN'S Eagle Brand Milk 14 OZ. CAN 59¢

DELICIOUS Cracker Jacks 3 FOR 29¢

PETER PAN SMOOTH OR CRUNCHY Peanut Butter 28 OZ. JAR \$1.49

BROASTED CHICKEN

serve chicken at its finest

BROASTED CHICKEN

It's our specialty!

It's cooked to order fresh to finished, in just minutes, especially for you.

Also: CORN DOGS AND BURRITOS

PHONE 247-3343

for families, for friends, for all occasions

CLIP THE COUPONS IN OUR AD EACH WEEK! REDEEM FOR 200 EXTRA GUNN BROS. STAMPS

#5 Expires March 18 THIS COUPON IS GOOD FOR 100 FREE GUNN BROS. STAMPS AT HOUSER'S No Purchase Required

Please fill in your name and city
Only One Coupon Per Customer - Coupon Expires

#5 Expires March 18 THIS COUPON IS GOOD FOR 100 EXTRA GUNN BROS. STAMPS AT HOUSER'S 2 Flashlite Batteries With the Purchase of

Please fill in your name and city
Only One Coupon Per Customer - Coupon Expires

SPECIALS GOOD WEEK OF MARCH 12-18

HOUSER VENTURE GROCERY

902 N. MAIN ST. PHONE 247-3343 FRIONA, TEXAS

VENTURE FOODS

READ and USE

CLASSIFIED ADS

PH. 247-2211

Reader Ads—First insertion, per word 10 cents
 Additional insertions (no copy change), per word 8 cents
 Minimum charge \$1.50
 Classified display (boxed ads—9 pt. type under a specific heading, 1 column width only—no art or cuts. Per column inch \$1.50

Cards of Thanks—same as classified word rate, minimum charge \$1.50

DEADLINE for classified advertising in Sunday's issue—5 p.m. Thursday.

Check advertisement and report any error immediately; The Star is not responsible for error after ad has already run once.

Portable Disc Rolling

Lewis Gore

Call 295-6188 or

Break 19 For The Mailman

Box 884, Friona, Texas

FOR SALE....1974 Ford Pickup, Ranger F-100, with top, Like new, 30,000 miles. Call Claude Blackburn, 247-2145. 16-tnc

FOR SALE....1972 Ford half-ton Ranger pickup. Power, air, automatic. Dual fuel tanks. Two fender tool boxes. CB antenna. Extra clean. Call 295-3729 nights. Dave Buske. 23-2tc

FOR SALE....360 Yamaha 360 Enduro motor on 250 MX frame. Like new. Make an offer. Call Rickey Rector, 247-3820. 17-tnc

We Are Now The Authorized Dealers In Friona For MICHELIN TIRES "The First Steel-Belted Tire" WHITE'S AUTO 15-tnc

FOR SALE....Good condition 1971 model Oldsmobile 98 luxury sedan. All the extras. See at 1210 Elm or phone 247-3153. 19-tnc

Your RADIO SHACK Dealer in Friona is White's Auto We Have CB Radios 22-tnc

CARD OF THANKS

The family of Mrs. Robert Peel would like to take this means of expressing our gratitude and thanks to all who brought food, for flowers, memorials, cards, prayers and every act of kindness shown during the loss of our loved one. May God bless each one.

Mr. R.H. Peel
 The Tom Balls
 The J.D. Balls
 The Tom O'Brians
 The Roy O'Brians
 The Tom Masons
 The Kenneth Moody's 23-1tc

The family of Elva Lou Lewellen wishes to express their appreciation for all the cards, flowers, memorials, food and prayers during our time of sorrow.

Joe Lewellen Family
 T.A. Kelley Family
 Gary Goetz Family
 Delton Lewellen Family
 E.D. Matlock Family 23-1tc

NEED A HOME LOAN?
 SEE FIRST FEDERAL
FIRST FEDERAL SAVINGS
 AND LOAN ASSOCIATION
 801 Pile St.
 762-4417
 Clovis, New Mexico

PRO AUCTION SERVICE

★ Any And All Types Of Sales

AUCTIONEER CLERK

LARRY POTTS LELAND GUSTIN

PHONE PHONE

295-6633 247-2146

FOR SALE....RCBS re-loading dies. One pair of 22-250, one pair of 25-06, one pair of 219 zipper. One 6mm bolt action rifle. Also sportsman library. Grape vines. Call 265-3462. 23-2tc

FOR SALE....30-inch electric range. Hide-a-bed, lounge chair. Bedroom suite with twin beds. Call 247-3105 after 5 p.m. 21-tnc

FOR SALE....Used Gold Velvet Swivel Rocker in excellent condition, \$59.00. Poarch's Furniture, 247-2035. 23-1tc

FOR SALE....9x12 storage building. Built by Junior High CVAE class. Contact B.F. McDowell, 247-3047. 11-tnc

FOR SALE....New Brown Vinyl Stratolounger Recliner with slight damage. Reg. \$199.00. Now 149.00. Poarch's Furniture, 247-2035. 23-1tc

FOR SALE....500 gallon propane tank with 240 pound working pressure. Phone 357-2595. 22-tnc

FOR SALE....Used 5 piece Dinette in good condition, \$49.00. Poarch's Furniture, 247-2035. 23-1tc

FOR SALE....50 Angus and Murry Grey Cross Cows Heavy Springers. Good condition. Von Edelman, 247-3497. 22-2tc

HELP WANTED
EQUAL OPPORTUNITY
EMPLOYER, Deaf Smith Electric Coop., P.O. Box 753, Hereford, Texas. Outside work, physical dexterity a requirement. Must have high school diploma or GED Certificate. Beginning salary \$4.16 per hour. 23-1tc

FOR SALE....two new three-bedroom houses. Two baths. Refrigerated air. Forced-air heat. Fireplace. Fully carpeted. Well insulated to save on heating. Double garage. 1703 West 10th and 1621 West Ninth. Shown by appointment. Phone 247-3290. 12-tnc

ATTENTION: MISSOURI BEEF PACKERS EMPLOYEES & FUTURE EMPLOYEES
 320 acres, irrigated with a lovely 3000 sq. ft. home, 4 bdr.-3 bath, double garage, enclosed playroom-patio, nice fenced back yard, one of the best country homes anywhere for nice, quiet country living.
THE BEST INVESTMENT ON EARTH IS THE TEXAS PANHANDLE
 200 South 25 mile Avenue Hereford, Texas 79045 806-364-0442
 Wilbur D. Gibson 364-2225
 Bill Struve 806-364-6396
 Norman Harder 806-364-1677
 Hiley Aven 806-364-1303 22-3tc

FOR SALE....3 bedroom, 1 1/2 baths, double garage. 307 N.W. 15th, Friona. Call 647-2319 or 276-5295. 15-tnc

FOR RENT
LARGE 4-Bedroom house for rent or lease. Call 267-2110 after 4 p.m. 21-tnc

Have you thought about an underground sprinkler system for your lawn? If so, call or come by the XIT Auto Ranch and let us show you the many benefits. We will give you a free estimate on your yard. We will also plow your garden spot, remove old trees and shrubs or put in new yards.

Call 247-2152
 Or See
Troy or J.D.
 At The **XIT** 23-2tc

DON'T LET YOUR REAL ESTATE NEEDS BLOW AWAY LIKE DUST

before you check with us.

Homes-Farms-Loans
 Property Management-Appraisals
 Complete Real Estate Service

Representing

Hi-Plains Savings & Loan

"SERVICE is our only Business"



Carol Gatlin

247-3641

CARROL GATLIN LAND CO.

102 E. 11th Office 806-247-2745
 FRIONA, TEXAS 79035

FOR SALE

2 BR house—308 E. 10th, \$6,500.

10 Acres on pavement. Near Friona.

Four 75-foot residential lots in Friona. Priced to sell.

640 Acres—4-8" wells. Some underground tile. Good water area, on North Plains. Priced to sell at 20 per cent down. Owner carry paper.

ED HICKS REAL ESTATE
 Office 247-3537 Home 247-3189

FOR SALE—New 3 bdr. brick with 3 acres in the country, \$75,000.00. The value is there, let me show you.

John Bingham Land Company
 1626 W. 9th St.
 Phone 247-3909

FOR SALE—WESTERN ADDITION—New 3 Bdr. Brick, shake shingles, basement. This house has it all, must see to appreciate.

John Bingham Land Company
 1626 W. 9th St.
 Phone 247-3909 22-3tc

FOR SALE....320 acres located 4 miles east of Lazbuddie. Two wells, good return water system (lake pump). All underground pipe. Good land, well improved. Selling for reasons of health. Phone 965-2256. 23-4tc

FOR SALE....320 acres located 4 miles east of Lazbuddie. Two wells, good return water system (lake pump). All underground pipe. Good land, well improved. Selling for reasons of health. Phone 965-2256. 22-4tc

SELL ON CONSIGNMENT

Let us sell your car or pickup, truck, tractor, combine, boat, camper, mobile home, motorcycle for you.

I have purchased the lot east of the XIT and have room to display your vehicle. Call or come by the XIT for details.

Troy Young

CUSTOM DISCING AND SPRAYING

★ CUSTOM APPLICATION OF HERBICIDES

★ CUSTOM DISCING

HUB AERIAL SPRAYING

PH. 265-3250 or 265-3840

IF NO ANSWER

CALL 265-3341 or 247-3181 3tc

ANNOUNCEMENTS

For HILCOA natural source vitamins, minerals and other dietary supplements. Call Irene Lotspeich 247-3107 6-tnc

Friona Lodge No. 1332 7th & Ashland. Slated Meeting 1st Tues. 8 P.M. J.W. Dixon-WM A.L. Outland-Sec.

PRICE OR QUALITY? We can give you quality prints at a reasonable price at Shafer's Photo, 218 W. 2nd, Muleshoe, Texas. Portraits, Commercial, Weddings and Copy Work.

Ronnie & Pat Shafer Shafer's Photography 218 W. 2nd, Muleshoe, Texas 79347. Phone 806-272-3487. 3-tnc

For Your Merle Norman Cosmetics. Call Sondra Nichols 247-2587. Or Now, At a New Location: RUTHIE'S 38-tnc

TA-NA-KE Yard Service Mowing, edging, fertilizing, professional tree and shrub care, topping, shaping and removal. Call 238-1495 after 5 p.m. 23-8tp

NOW....In Friona. You can come direct to us and discuss a mortgage loan, or a home improvement loan. Let us visit with you on any financial question you might have. Tri-County Savings & Loan, 106 West Ninth, Friona. 16-tnc

AUTOMOTIVE
FOR SALE....New and used Huntsman Mini-Motor Homes. In stock, ready for immediate delivery. 84 month financing available. FRIONA MOTORS. Call 247-2701. 22-4tc

BUSINESS DIRECTORY

ADAMS DRILLING CO., INC.
WATER WELL DRILLING
 Layne Pumps, Inc. Pump & Gear
 Zimmatic Sprinklers Head Repairs
 Sales & Service All Makes
 Dial 247-2731
 Friona, Texas

Your local used cow dealer is.....

Friona Bi-Products
 For 7 day a week dead stock removal. Call 247-3032 Collect

TELEX
CLOVIS HEARING AID CENTER
HEARING AIDS
 ★ Batteries ★ Molds ★ Free Hearing Test
SERVICE ALL MAKES
 403 E. 14th Phone 763-6900 9tnc

FARM SALES
 ★ FREE APPRAISALS
 ★ GUARANTEE ALL CHECKS
B & B AUCTION SERVICE
SEE AT BIG NICK'S
BIG NICK (806) 238-1614
HOUSTON BARTLETT 225-6699
FRIONA NIGHT PHONE 247-3084

M.D. Lovvorn
Dirt Moving
 Tailwater Pits
 Land Leveling Dams
 25 Years In This Area
 Box 544, Farwell, Texas
 Phone (806) 481-9029 7-tnc

WT Telephopne Co-op Sets Annual Meeting

The 23rd annual meeting for the West Texas Rural Telephone Cooperative will be held on Thursday, March 17 in Hereford. The meeting begins with registration and dinner beginning at 6 p.m., with the business session at 7 p.m.

During the business session, members will elect three members to the WTRTC board of directors, according to manager Tom Hyer.

Spots up for election include the newest exchange on the WTRTC network, Milo Center, where the incumbent, Carl Straffuss will be opposed on the ballot by Larry Harris.

Also to face re-election is Jimmie Cockerham of the Tharp exchange, opposed by Tommy Williams, and Ernest Brown of the Westway Exchange, opposed by Jimmy Bradley.

Holdover directors include George L. Olson, Frio; Robert Strain, Dawn; Billy Mayfield, Oklahoma Lane; Charles Myers, Hub; J.B. Noland, Summerfield and Harold Joe Wells, Parmer.

Telephone cooperative members are urged to register for door prizes beginning at 6 p.m. meeting day.



YOU CAN OWN A WESTERN AUTO STORE IN:
FRIONA, TEXAS
LOCKNEY, TEXAS
MEMPHIS, TEXAS

There is an opportunity available in the above towns for a Western Auto Associate Store selling hardware, sporting goods, automotive supplies, furniture, refrigerators, freezers, washers, televisions, C.B.s., radios, other electronics, etc.

We will train you, help install your store and provide counseling after you're open. Financing is available to qualified prospects. If you're interested in owning your own Western Auto Associate Store call this toll free number today.

800-821-7700 Ext. 818

Or write:
R. T. Reinfr, VP, Western Auto
2107 Grand Ave., Kansas City, Mo. 64108
Be sure to provide your phone number and complete address.

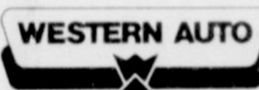

Schueler Services Held At Rhea

Herman John Schueler, 82, a resident of the Rhea Community Since 1918, was found dead in his home at Rhea at 12:30 p.m. Tuesday, March 8 of natural causes. He had been in good health up until the time of his death.

Herman was the son of Jacob and Catherine (Schmidt) Schueler. He was born January 28, 1895 at Preble, Indiana. He was baptized February 10, 1895 at St. Paul Lutheran Church, Decatur, Indiana and confirmed at St. Paul's in 1908. He was a World I veteran.

Herman Schueler and Emma Louise Gallmeir were married September 1, 1918 at St. Paul's Lutheran Church in Preble, Indiana. They moved to Texas in 1918 where they lived in the rock house 1/2 mile north of the Rhea Lutheran Church most of the 52 years of their married life.

They built a three bedroom home in the Rhea Community east of the present Lutheran parsonage in 1967 and celebrated their Golden Wedding Anniversary in 1968. Herman continued to reside in their home following Emma's death April 26, 1970. Yard work and a garden in the summer were a joy for him. He was a retired farmer and was still active in helping maintain the church grounds and cemetery at Rhea.

Funeral services were conducted Thursday, March 10 at Immanuel Lutheran Church in the Rhea Community at 2:30 p.m. with Rev. William Ruple and Rev. Herman Schelter officiating. Burial was in Rhea Cemetery by Parsons-Ellis Funeral Home of Friona.

Pallbearers were Norman Taylor, Jack Patterson, Cordie Potts, Earl Boyd, Richard (Andy) Anderson and Chris Drager.



HERMAN JOHN SCHUELER

Three children, an infant daughter and daughters, Lillian and Dorothy preceded their father in death. Survivors include one daughter, Velma of the Rhea Community, and three sons, Gilbert of Alamosa, Colorado, Walter and Herbert, both of the Rhea Community, and a son-in-law, Franklin Bauer of Everton, Missouri.

Twenty-four grandchildren and five great-grandchildren also survive. Other survivors at Rhea include a sister-in-law, Mrs. Robert (Anna) Schueler; nephews and their wives, Ray and Lorna Schueler, Norbert and Retta Schueler, Floyd and Glenda Schueler and Robert Schueler Jr.

Legal Notice

ELECTION ORDER AND NOTICE

In regular session on the 14th day of February 1977, the Board of Trustees of Friona Independent School District passed the following order:

WHEREAS, the term of office of David Grimsley and Jerry Hinkle, members of the Board of Trustees of this School District will expire on Saturday, April 2, 1977, that on said date a trustee election will be held in said School District for the purpose of electing two trustees.

This election will be held for the District at the Friona Fire Station from 7:00 A.M. until 7:00 P.M. on Saturday, April 2, 1977.

Absentee voting shall be conducted from March 14, 1977 thru March 29, 1977 at the Administrative Office of Friona Independent School District between the hours of 8:00 A.M. and 4:30 P.M. on each day that is not a Saturday or a Sunday.

Published by order of Board of Trustees of Friona Independent School District.

Wesley Barnett
President
Ronald D. Smiley
Secretary

23-1tc
"He that can endure all can dare all." Vauvenargues

ORDEN Y AVISO DE ELECCION

En sesion regular del 14 de febrero de 1977, los Administradores del Distrito Escuela Independiente de Friona pasaron el orden siguiente:

EN VISTA de que el regimen de David Grimsley, y Jerry Hinkle, miembros del Consejo de Administradores, espira el sabado el 2 de abril de 1977 y en dicha fecha se llevara a cabo una eleccion de administradores en dicho Distrito Escuela para el proposito de elegir al Consejo de Administradores de dicho Distrito Escuela, dos administradores.

Esta eleccion se llevara para el Distrito a la estacion de bomberos en Friona desde las 7:00 A.M. hasta las 7:00 P.M. el sabado, el 2 de abril de 1977.

La votacion ausente se llevara desde el 14 de marzo de 1977 hasta el 29 de marzo de 1977 en la oficina de Administradores del Distrito Escuela Independiente de Friona desde las 8:00 A.M. hasta las 4:30 P.M. cada dia de votacion ausente no siendo sabado o domingo.

Publicado por orden del Consejo de Administradores del Distrito Escuela Independiente de Friona.

Wesley Barnett
Presidente
Ronald D. Smiley
Secretario

FOR SALE...3 bedroom, 1500 plus square feet home. New carpet. Recently painted and paneled. Appraised at \$16,500.00. Qualified buyer can move into for \$1,650.00 plus normal closing costs. Call 247-2505 after 5 p.m. for appointment.

WANTED

WANTED.....Housework or light yard work. Call 247-3887 and ask for Jeannie 23-1tp

WANTED....Farm work. I am experienced. Call Dave at 265-1363. 23-2tc



Henry W. Block

"If there's a way the new tax law can save you money, we'll find it."

A brand-new reason why H&R Block should do your taxes.

The new 1976 tax law is full of changes. New credits...new deductions...new rules that affect you and every taxpayer. But Block people are ready to help save you money by taking every allowable deduction and credit.

H&R BLOCK

THE INCOME TAX PEOPLE

Open 9 a.m.-6 p.m. Mon.-Fri. 9-5 Sat.

Phone 247-3838

511 Main, Friona

NO APPOINTMENT NECESSARY

24-Hour Service on Small Returns

LUNCH MENU

Week of March 14-18

MONDAY—enchilada casserole, buttered corn, crackers, lettuce and tomato salad, brownies and milk.

TUESDAY—meat loaf, mashed potatoes, hot rolls-butter, English peas, pineapple rice pudding and milk.

WEDNESDAY—pinto beans, barbecued franks, cornbread-butter, mixed greens, apricot cobbler and chocolate milk.

THURSDAY—fish, macaroni and cheese, tartar sauce, banana pudding, green beans, hot rolls-butter and milk.

FRIDAY—hamburgers, French fries, catsup, lettuce, tomatoes, pickles, fruit salad and milk.

LOW FOOD PRICES *ON THE MARCH FOR ST. PATRICK'S DAY

PRICES GOOD WEEK OF MARCH 12 THRU MARCH 18

MIRACLE WHIP 32 OZ. \$1.19

GOLD MEDAL FLOUR 25 LB. BAG \$3.19

WHITE SWAN BUTTERMILK BISCUITS 3/35c

7-UP 32 OZ. BOTTLE \$1.49

SOFT OLEO 49c LB. TUB

CARNATION INSTANT DRY MILK \$2.25 8 QT.

FROZEN FOOD MRS. PAULS FISH STICKS 14 OZ. \$1.39

BORDEN ICE CREAM 99c 1/2 GAL.

FLAV-R-PAC CHOPPED BROCCOLI 10 OZ. 37c

CRACKERS 73c LB. BOX

FRANKS 69c 12 OZ.

CLUB STEAKS \$1.39 LB.

PRODUCE RUSSET POTATOES 20 LB. BAG \$1.49

SUNKIST ORANGES 23c LB.

AVOCADOS 2/45c

DON'T FORGET OUR PHOTO CONTEST TUESDAY MARCH 15TH

How to grow a pot full of money



Open a Green Pastures Savings Account

Planting instructions: Sow in a small amount each week on a regular basis. We'll do the rest. At The Money Growers Association we nurture it, insure it and care for it till your money grows with interest.

Join The Association, now. Money planted today will begin to blossom today!

THE MONEY GROWERS ASSOCIATION 5 1/4% - 6 1/2% - 7 3/4%

FRIONA Representative GATLIN LAND CO.

hi-plains savings & loan

HEREFORD & DIMMITT

"We look to your future with interest."

WHITE'S SUPERMARKET

OUR AIM IS TO PLEASE IN EVERYWAY WE GIVE GUNN BROS. STAMPS

WE ACCEPT USDA FOOD STAMPS

WE DELIVER

PHONE 247-2250

DOUBLE STAMPS ON WEDNESDAYS WITH PURCHASE OF \$2.50 OR MORE



Chiefs Sparkle In Abbreviated Meet

Friona Chieftain tracksters were off to a fine start last Saturday at Littlefield's Wildcat Relays, before meet officials huddled and cancelled the meet at 11 a.m. at the end of the preliminaries and field events.

Although no medals were awarded, Koty Kothmann had won the discus throw with a heave of 126-5, and had placed fifth in the shot put.

Mark Neill had jumped 18-3 in the long jump, Mike Hutson and Jeff Whiteside 17-9 each.

David Fleming, freshman moved up to the varsity, had the fastest qualifying time in the 440-yard dash, winning his heat in the good time (considering the elements and the early season) of 55.4. Robert Alexander had a 57.6 timing to qualify in this event, and Paul Ortiz was in the finals with 57.9.

Others doing well in the preliminary races completed were Larry Walker, Eddie Brailiff and Jeff Whiteside in the 100-yard dash, and Todd Bandy, Leslie White and John Jarecki in the 120-yard high hurdles.

"I was really pleased with the way the young men competed. I felt that

we would have won the meet if it had been continued," said Chieftain coach Gary Jones.

The Chiefs are entered at Abernathy this Saturday. Jones

Letter To The Editor

Dear Sir:

I am enclosing my check to pay for another year's subscription to the Friona Star for my son.

I enjoy the Star every week. You are publishing a better paper every week. I manage to visit my brother every year and am surprised every time to see the big improvements in Friona and the country surrounding.

I first came to Friona in May of 1908, and lived on a farm west of Friona until 1949. So I always look forward to my visit each year.

Respectfully,
Mary Ford
Mineola, Texas 75773

gave this lineup of entrants for each event:

440-relay: Larry Walker, Ram Randolph, Todd Bandy, Eddie Brailiff, Jeff Whiteside.

100-yard dash: Larry Walker, Eddie Brailiff, Ram Randolph.

220-yard dash: Larry Walker, Eddie Brailiff, Ram Randolph.

440-yard dash: David Fleming, Mark Neill, Paul Ortiz.

880-yard dash: Glenn London, Louis Rodriguez, Robert Alexander.

Mile run: Joe Bermea, John Ingram, Danny Mendoza.

120 yard high hurdles: Todd Bandy, John Jarecki, Leslie White.

330-yard intermediate hurdles: Todd Bandy, Mike Hutson, John Jarecki.

Mile relay: Mark Neill, Robert Alexander, Paul Ortiz, David Fleming.

Shot put: Koty Kothmann, Jeff Peak, Glenn London.

Discus throw: Koty Kothmann, Jeff Peak, Glenn London.

Pole vault: Leslie White.

High jump: Mike Hutson, Mark Neill, Leslie White.

Long jump: Mike Hutson, Mark Neill, Jeff Whiteside.

Morton, DHS Top All-Stars

State champion Morton and district runnerup Dimmitt dominated the All-District 3-AA team announced this week by district coaches.

Making the 12-man team from Friona was senior center Mark Neill. Junior Jeff Whiteside gained honorable mention honors.

On the team from Morton were Troy Patton, Lonnie Harrison, Rusty Lamar and Bobby Patton. Dimmitt landed Keith Crum, Jerry Schaeffer, Rocky Rawls and Johnny Hampton.

Littlefield had two men on the team, Narja Simington and Ralph Mendez. Muleshoe landed Billy Wisian on the team.

On the girls' all-district team, champion Dimmitt dominated the squad with eight places.

Friona gained three honorable mention places, Diane Bennett, Rhonda Parsons and Sheri Rector.

Customized Grain Handling Systems

Now Available From

POARCH BROS.

WITH 30 YEARS LOCAL EXPERIENCE IN CUSTOM GRAIN HANDLING, DRYING AND FEEDING SYSTEMS

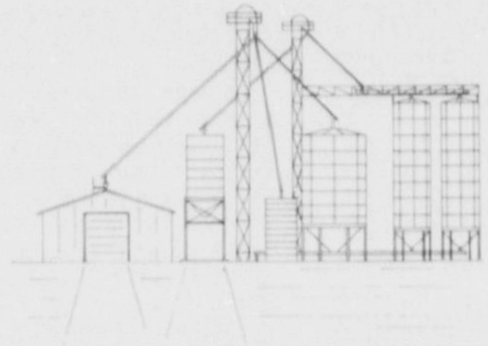

COMPLETE DESIGN, ENGINEERING, FABRICATION AND INSTALLATION

CALL (806) 364-0015

POARCH BROS.

HEREFORD, TEXAS

Whiteside Is Top Scorer For Chiefs

Junior Jeff Whiteside paced the 1976-77 Friona Chieftains in scoring, according to statistics released this week by Coach Jimmy Pope.

Whiteside scored 414 points in a 31-game schedule for a 13.7 points-per-game average. Mark Neill was close behind with 398 points and a 12.8 average.

In the shooting department, Whiteside and John Jarecki were in a virtual tie for tops in the field goal percentage, each at 43.6 per cent.

Neill was the leading free thrower, hitting 61.2 per cent of his shots, 82 of 134.

Neill also had the dubious honor of drawing the most fouls, 108. Koty Kothmann was the team's leading rebounder with 229, followed by Neill with 152.

As a team, the Chieftains finished with a season record of 17-14.

LEADING SCORERS

Player	G	FG	FT	TP	Avg.
Jeff Whiteside	31	164	86	414	13.7
Mark Neill	31	158	82	398	12.8
Koty Kothmann	31	108	67	283	9.1
Keith Martin	31	59	47	165	5.3
John Jarecki	31	65	21	151	5.0
Kevin Kothmann	26	48	28	124	5.2
Todd Bandy	31	34	15	83	2.6
Paul Ortiz	20	22	7	51	2.6
Jeff Peak	27	20	9	49	1.8
Lawrence Fithen	9	8	4	20	2.2
Glnt Mears	21	4	2	10	0.5
Totals	31	694	375	1753	56.5

SHOOTING PERCENTAGES

Player	FGA	FG	Pct.	FTA	FT	Pct.
Whiteside	374	164	43.6	145	86	59.3
Martin	196	59	30.1	78	47	60.2
Neill	509	158	31.0	134	82	61.2
Jarecki	149	65	43.6	43	21	48.8
Koty Kothmann	274	108	39.0	131	67	51.0
Kevin Kothmann	121	48	40.0	46	28	60.9
Bandy	111	34	30.0	29	15	52.0
Peak	50	20	40.0	25	9	36.0
Mears	23	4	17.0	2	2	100.0
Fithen	25	8	32.0	18	4	25.0
Ortiz	64	22	34.0	13	7	54.0
Totals	1908	694	36.3	667	375	56.2

SUNFLOWERS

the 'NET PROFIT' crop



New markets that continue expanding.

Early crop, fast maturing, first annual income.

Total water requirements 60% of other crops.

Producers proclaim the easiest crop grown.

Responds well to fertilizer (with or without).

Off season harvest (spreads workload).

Freeze tolerance, sand resistant, control weeds.

Is adaptable to all types of soil.

Total cash input for crop much less.

"Plant Sunflowers for More Net Profit"

"The Sunflower People of West Texas"

John F. Herzer & Associates.....806-792-4418

SUNFLOWERS

the "NET PROFIT" crop

We now have available GROWER CONTRACTS for the 1977 CROP, we can supply TOP QUALITY HYBRID PLANTING SEED at reduced cash prices. We also have planting seed for contracts that allow you to PLANT NOW, and PAY LATER, plan ahead, plan now to PLANT IN APRIL, take advantage of moisture, fertilize well and HARVEST IN AUGUST for early cash when it's needed.

"The Sunflower People of West Texas"

JOHN F. HERZER & ASSOCIATES

Lubbock 792-4418

Contact WINSTON WILSON at the Highland Motel in Muleshoe or Phone 272-4535

SUNFLOWERS work great on graze out or harvested wheat land as second double crop, fast maturing sunflower varieties allow grower to go back to wheat in same year.

Our "Joint Venture Contracts" guarantees the grower \$9.00 per 100 wt., for his total sunflower crop and we share a 50% profit to the grower on a joint venture market price at harvest time above the \$9.00 guarantee, based on JFH contracts. Good dryland crops yielding from 900 to 1500 pounds per acre. Good irrigated crops yielding from 1800 to 3000 pounds per acre. We have receiving points at: Claude, Groom, Pampa, Perryton, Spearman, Vega, Gruver, Etter, Happy and Dimmitt.



BUICK - GMC - PONTIAC

JOHN ORSBORN

30 YEARS IN HEREFORD!

See Us And SAVE

142 Miles Ave. - Here.

Phone 364-0990

WHERE YOU BUY THE BEST FOR LESS

WHERE YOU ALWAYS BUY THE BEST FOR LESS
GIBSON'S
DISCOUNT CENTER

your
BANKAMERICARD
 welcome

master charge
 THE INTERBANK CARD

FRONA, TEXAS

STORE HOURS ... 9 a.m. to 7:30 p.m.

ADVERTISED SPECIALS GOOD MARCH 12 - MARCH 19



HERE'S YOUR CHANCE FOR A

SPRING SAVINGS Spree

JUST ARRIVED
 NEW SHIPMENT OF FERTILIZER

ONLY 2 LEFT
 THE HOME PRO BY TORO

LAWN MOWER

3.5 H.P. M
 Aluminum
 Deck
 With
 Grass
 Catcher

\$149⁹⁹

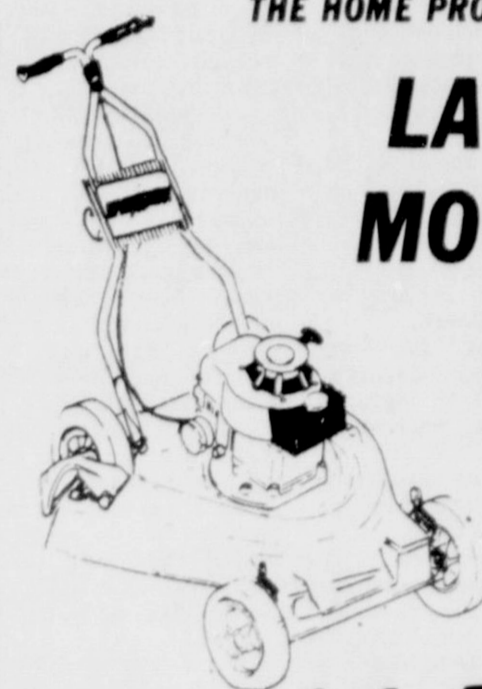

VULCAN 3 H.P.
 BRIGGS STRATTEN

LAWN MOWER
\$79⁹⁹

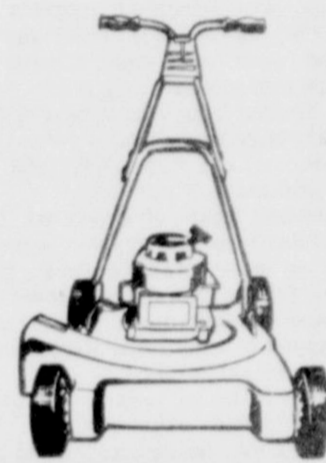

ALL
 GARDEN
 TOOLS
25%
 OFF
 REG. PRICE

RAIN WAVE
 OSCILLATING
LAWN SPRINKLER
 WATERS 34'X65'
 UP TO 2,200 SQ. Ft.
\$3⁹⁹
 ONE YEAR GUARANTEE



TRIM-ALL
ELECTRIC TRIMMER

AND **EDGER** FOR WEEDS & GRASS
 HEAVY DUTY NYLON CUTTING LINE

\$23⁹⁹

WHILE SUPPLY LASTS

ROTARY MOWER
THATCH-AERATOR

LAWN
 GROOMING
 BLADE **\$1⁹⁹**



SPORT CRAFT NO.08050
RING TOSS GAME
\$6⁵⁹

SPORT CRAFT
RUBBER HORSESHOES
 COMPLETE
 OUTDOOR GAME **\$4⁷⁹**

PAINT
 BRUSHES
10% OFF



Gibsons
SPRAY PAINT ENAMEL
99^c

BUDDY L
GRILL MASTER
 WITH ROTISSERIE
\$17⁹⁹



GERING
GARDEN HOSE
 5/8"
 50 FT. LENGTH
 No.G-58-50-14
\$3³⁹



GOTHAM
ICE CHEST
 KEEPS FOOD HOT or COLD



REG. \$1.19 ... **99^c**
 \$1.79 ... **\$1⁴⁹**
 \$2.99 ... **\$2⁴⁹**

3 TUBE
 SOAKER
SPRINKLER HOSE
 Sprinkles Like A Soft Gentle Rain

No. GSK-50
 50 FOOT
\$2⁹⁹

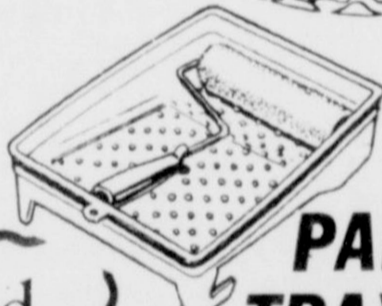

PAINT TRAY & ROLLER SET
\$1¹⁹



DOWNY
\$1⁷⁹

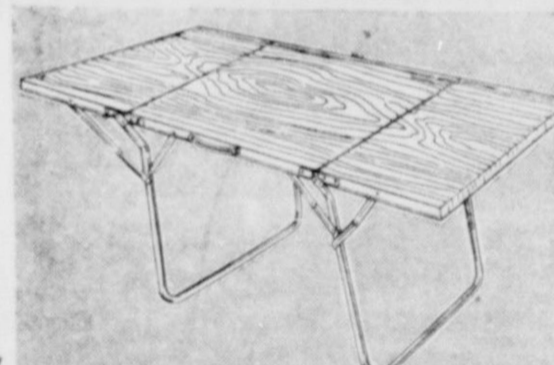

DELUXE NO. 111
FOLDING TABLE
 Easy To Open,
 Carry, Close
 & Store. **\$12⁴⁹**

OUTDOOR
 50 FOOT
EXTENSION CORD
 NO. OSHA
 REG. \$5.97 NOW **\$4⁴⁹**

THIS WEEK'S
PHOTO SPECIAL
 20 EXPOSURES
 DEVELOP & PRINT
\$2⁹⁹

Isn't that you behind those Foster Grants?



Sure it is. Looking merely sensational in those great-looking Foster Grant sunglasses. Foster Grant is the line that has everything, so you can choose from a truly spectacular selection of lenses and frame styles. Hey, isn't that you behind those Foster Grants?

20% OFF GDP



RING SPRINKLER
 NO. 112 **99^c**



WHITE SWAN
BLACK PEPPER

4 OZ. **37^c**

SUAVE
SHAMPOO
 ASSORTED SCENTS

16 OZ. **79^c**

Anthony Re-Elected To DS REC Board

An estimated crowd of 1100 attended the 39th annual meeting of Deaf Smith Electric Cooperative March 5, at the Hereford Bull Barn. Capital Credit checks totaling \$437,610.08 were returned to members who purchased electricity during 1964.

Earnest Langley, attorney for Deaf Smith REC, directed the business meeting. The meeting was called to order by President Sloan Osborn, Friona. Following a report by Secretary A.W. Anthony, Jr., of Friona, an election for two directors was held.

Jerry Roberts, who farms in the Sims Community, won the position of Director for Deaf Smith County over veteran Raymond Higginbotham, who had held the post for the past 17 years, and served as vice-president of the Board.

A.W. "Dub" Anthony, Jr., was re-elected as Farmer County's Director over W.S. "Dub" Ingram. Anthony served as secretary-treasurer during 1976.

The crowd paid tribute to retiring Higginbotham and gave him a standing ovation for his many years of service to the Cooperative.

Drawings for various door prizes were held throughout the meeting, which began with a barbecue dinner served by the Catholic Daughters of Nazareth.

Highlight of the drawings was a microwave oven won by Eva Valdez of Hereford.

James Hull, manager of the Cooperative, addressed the crowd in an effort to bring the membership up to date on cooperative matters of 1976. He stated that 1976 was a banner year with over a million dollars in margins being made, and that member equity, that part of the electric cooperative that is owned by the member has remained stable at approximately 47 per cent.

"Another figure of which we are particularly proud is our outage time, or power failure time. Our power failure in 1976 amounted to one and one-half hours per meter, compared to a national average of five hours per meter."

Hull stated the largest problem these days is explaining to the members the limitations placed on the REC's peak demand growth. The cooperative grew at an annual rate

of 19 per cent but has been asked to restrain this growth to 6.5 per cent which is 2.5 per cent above the national average.

"It is not that Southwestern Public Service Co. does not want to supply us additional power, it is just that their construction schedule is firm throughout 1982... We have looked into other sources of power, from other power suppliers, but the economic feasibility of transmitting into this area, power from other generation sources is just not economically feasible," Hull stated.

Another avenue that is being explored is the feasibility of enacting a load management program. Load management as described by Hull, would permit the cooperative to interrupt a certain electric load, if agreed to by the member, should the cooperative system's peak begin to reach a critical stage. A maximum of 50 hours per month during the months of July and August are some of the stipulations placed on the cooperative's load management plan.

"We are admittedly moving very slowly on this new project, we are so to speak, 'plowing new ground,'—no other electric cooperative in Texas has initiated this type of program," Hull said.

A bit of good news, Hull added, is the REC's ability to acquire all the needed capital for investment in plant expansion through loans with the Rural Electrification Administration and CFC, which is the National Rural Utilities Cooperative Finance Corporation.

Hull's opinion is that the much publicized pass-through, termed "fuel adjustment charge" is anticipated to increase at about the same rate as inflation that we have in the United States. His logic being that all fuels for generation of electricity are made available through the use of labor and labor contracts are, in most cases, tied to the cost-of-living index as determined by our federal government.

In conclusion, Hull thanked the member-owners of Deaf Smith Electric for their patience in working with the Cooperative through the energy crises, and period of energy shortage.

Jr. High Meet

Friona Junior High School's boys track teams entered the Roughrider Relays at Boys Ranch last Saturday.

The seventh grade finished second in their division with 70 points. Winning their division was Panhandle with 74 points.

Friona could have won the seventh grade division, as its 440-yard relay team had the best qualifying time, but was disqualified for passing the baton out of the specified handoff zone.

The eighth graders placed third in their division, scoring 72-1-3 points and getting three first-place efforts.

Claiming first-place medals were Delton Rando in the high jump, Mike Leal in the 880-yard dash and Mark Blankenship in the 1320-yard run.

Seventh graders scoring wins were Tony Rios in the discus throw and Robert Caballero in the 400-yard dash. In addition, the seventh grade Braves had five second place finishes, including two by Rios who was their high point individual with 26 points.

Mike Leal was the high point man for the eighth graders with 22 points.

Those scoring points for Friona in the meet were:

SEVENTH GRADE

Shot put: Tony Rios, second, 35-0. Discus: Tony Rios, first, 98.6. Long jump: Robert Caballero, second, 15-4. 100-yard dash: Tony Rios, second, 11.8. 220-yard dash: Nelson Jackson, third, 27.1. 100-yard low hurdles: Rudy Mendoza, second, 14.5. 60 yard intermediate hurdles: Marciano Escalante, fourth, 10.7. 440-yard dash: Robert Caballero, first, 61.9. 440-yard dash: Robert Caballero, first, 61.9; Marciano Escalante, second, 64.2.

EIGHTH GRADE

High jump: Delton Rando, first, 5-4; Mike Leal, fourth, 4-8. Shot put: James Clark, fifth, 37-7. Long jump: Martin Mercado, fifth, 15-7/8. 60-yard IH: Mike Leal, fourth, 9.3. 100-yard low hurdles: Martin Mercado, second in qualifying, but fell in finals. 440-yard dash: Mercado, second, 57.8. 880-yard dash: Leal, first, 2:15.4. 1320-yard run: Mark Blankenship, first, 3:53.1; Manuel Romo, second, 3:54.3. 880-yard relay (Tony Jackson, Mike Leal, Craig Lookingbill, Martin Mercado), second.

FARM EQUIPMENT AUCTION

WEDNESDAY MARCH 16, 1977

TIME 1:30 P.M. CST

OWNER: JIM DIXON & OTHERS

LOCATED from Friona, Texas 2 miles East on Highway 60 then 2 miles North on dirt road.

I have sold my irrigated farm and with no further need for irrigated equipment I will sell at Public Auction the following list of machinery:

PICKUPS	IRRIGATION EQUIPMENT
1 1973 Ford Courier with 24 Volt Starting System & Pipe Carriers	1 Pipe Trailer Single Axle
1 Old Chevrolet Pickup (Salvage)	24 Joints 30"x8" Flow Line
	60 Joints 40"x6" Flow Line
	24 Joints 8" Gated Pipe with 2 1/2" Outlets 40" Spaced
	10 Joints 7" Gated Pipe with 2 1/2" Outlets 40" Spaced
	21 Joints 6" Gated Pipe with 2 1/2" Outlets 40" Spaced
	1 Lot Hydrants
	1 Lot Spacers
	1 Lot L's
	1 Lot T's
	1 Lot End Caps
FARM EQUIPMENT	MISCELLANEOUS
1 Big Ox 9 Shank Chisel with double gauge wheels	1 Portable Loading Chute (Adjustable to double deck)
1 J.D. 444 Corn Head (New in 1976 - has cut 300 acres)	1 5 Row set of Markers
1 IHC 642 4x16" Moulboard	1 500 Gal. Butane Tank
1 Schlabs Clod Buster	1 250 Gal. Butane Tank on 2 Wheel Trailer
1 Servis 72" Shredder (Hyd. Cont)	1 250 Ga. Fuel Tank on 2 Wheel Trailer
1 IHC 60 Tandem Disc 9'	1 Forney 180 Amp. Welder
1 Krause 411 Tandem Disc	1 Pickup Tool Box (for small pickups)
1 J.D. 4 Row Flex Rotary Hoe	1 Lot Electric Fence Wire
1 Big Ox S-69 3 Point Blade (Good)	1 Lot Electric Fence Post
1 IHC 3 Point Blade 6'	1 Lot Sweeps
1 3 Point Dirt Scoop for small Tractors	1 Lot Cylinders
1 IHC 55 5 Row Lister	1 1000 Gal. Butane Tank
1 Meyers Drag Type Ditcher	
1 15' Railroad Iron	
1 5 Row Double Tool Bar Rig Shanks Gauge Wheels 3 Point	
1 KMC Kelley 6 Row Rolling Cultivator (Good)	
1 Hamby 21' Stubble Mulch Plow with 3 Point	
1 J.D. 7100 6 Row Planter (Like New)	
1 Miller 18' Offset Disc	
1 Caldwell 4 Row Shredder	
1 J.D. 20x8" Wheat Drill	

BAD WEATHER DATE MARCH 23, 1977

THURSDAY MARCH 17, 1977

TIME 1:00 P.M. CST

OWNER: ROSS TERRY & OTHERS

LOCATED Southwest side of Friona, Texas on Highway 60

We will offer at Public Auction the following list of equipment:

TRACTORS	FARMING EQUIPMENT	TRACTOR & TOOL MAKEUPS
1 1971 J.D. 4020 SN 252960R Factory Cab AC Dual Hyd. Power Lock Rear End (Good)	1 J.D. 9 Shank Deep Chisel Gauge wheels & Tandem Disc Hitch for 4020 J.D.	1 15:5x38 Duel Tractor Tires & Hubs for 4020 J.D.
1 1968 IHC 1256 SN 113415-Y Factory Cab Long Axles 18.4x38 Tires (Good)	1 6 Row Lilliston Rolling Cultivator Gauge wheels 2 4"x4" Bars (Good)	4 16:9x38 Tractor Tires
1 1976 J.D. 830 SN 49554 700 Job Master Frontend Loader (like new; 83 hours)	1 Eversman V Ditcher Cylinder Lift (Like New)	1 16:9x34 Tractor Tire
1 1957 J.D. 70 Diesel Wide Front (Good)	1 4 Row J.D. Flex Planter & Bed Shaper	1 18:4x38 Tractor Tire
	1 14' Krause Tandem Disc	1 Set (6 Row) Baring Off Disc for Lilliston
	1 Big Ox S-69 Blade (Good)	1 Set (6 Row) Baring Off Disc & Veg. Knives for Lilliston
	1 J.D. 15' Oneway (Good)	1 5 Row Set of Markers
	1 J.D. 5 Row Lister	2 21' 2 1/2" J.D. Tool Bars & Gauge Wheels
	1 4 Row Big 12 Cultipacker	TRAILER & TANKS
	6 71 J.D. Flex Planters (Good)	1 Worley 2 Horse all metal trailer
	1 J.D. 20x8" Drill	1 1500 Gal. Water Tank on 4 Wheel Trailer (Good)
	1 Lilliston 4 Row Rolling Cultivator	1 500 Gal. Water Tank
	1 6' Brillion Clod Buster	1 250 Gal. Anhydrous Tank
	1 IHC 314 Breaking Plow with Slot Wings	1 16' All Metal 4 Wheel Trailer with 8:25 Tires
	1 J.D. 407 Gyramor Shredder-3 point (Good)	1 Flat Bed Winch & Gin Poles for 1 Ton Truck
	1 18' Shaffer Tandem Disc	1 16' White House Boat with 75 hrs. Johnson Motor with easyload Trailer
	1 4 Section Rotary Hoe-3 point MM 16x10" Drill	1 35 hrs Evinrude Motor (Good)
	1 J.D. 4 Row Front Mount Cult. (Good)	ENSILAGE & HAY EQUIP.
	1 J.D. 58 Front End Loader (Good)	1 Gehl Chop Al Ensilage Cutter Self Propelled - 2 Row
	1 5 Row Rod Weeder on Triple Tool Bar with gauge wheel & J.D. Orchard Shanks	1 New Holland 905 Swather 14' Header
	1 J.D. 16' Oneway	1 Massey Ferguson No. 12 PTO Bailer
	1 6 Row Bed Shaper on Double Tool Bar	1 Graves Bale Loader
	1 4 Row Lilliston Rolling Cult.	1 J.D. 2 Row Ensilage Cutter Model 38 PTO Drive
		1 1974 Heston Model No. 420 Swather
MISC & MOTORS		Many Many Items too Numerous to Mention.
1 A Frame & Hoist for pickup	5 605 Moline Motors (Good)	
1 Lincoln SA200 Portable Welder	2 800 Moline Motors (Good)	
1 Champion Air Compressor with 3 HP Electric Motor (Like New)	1 Lot Tires	
1 Amarillo 50 HP Rear Head	1 Trailer Axle Fits Hobbs American Lufkin and others (Good)	

BAD WEATHER DATE MARCH 24, 1977

ALL CONSIGNMENTS WELCOME TILL SALE TIME

PRO AUCTION SERVICE

Big or Small We Work Them All
Call us for any type
Liquidation or Auction
Free Appraisals TX GC-77-0477

AUCTIONEER LARRY POTTS FRIONA, TEXAS PH. 295-6633	CLERK LELAND GUSTIN FRIONA, TEXAS PH 247-2146
---	---

ALLSUP'S CONVENIENCE STORES

AMERICA'S FAVORITE FLAVOR!

PRICES GOOD THURSDAY MARCH 10 THRU SATURDAY, MIDNIGHT MARCH 12

SHOP THE FRIENDLY, CONVENIENT ALLSUP'S STORE NEAR YOU!

Favorite Things Sale

Savings thru-out the Store!

Shurfine Flour	FRESH PRODUCE SAVINGS
PAPER BAG 5 LB. BAG 49c	ALL PURPOSE RUSSET POTATOES 10 LB. BAG 79c
Shurfine Sugar	BACON
GRANULATED 5 LB. BAG 79c	\$1 19
Shurfine White, Yellow or Pink Facial Tissue	Shurfine Regular or BEEF FRANKS
20 SHEETS 8 1/2" X 5 1/2" 10 UNDS. CAR 89c	12 OZ. PKG. 69c
Shurfine Fruit Cocktail	Shurfine Regular or BEEF BOLOGNA
15 UNDS. CAR 69c	12 OZ. PKG. 79c
Shurfine 3 Sieve Cut Green Beans	FAVORITE BORDEN'S BUYS
1 POUND PACKAGE 1 00	BORDEN'S BUTTERMILK
Shurfine Margarine Quarters	1/2 GAL. CTM. 59c
SHURFINE 18 OZ. CAR 89c	BORDEN'S ICE CREAM
Yellow Climbing Halves or Sliced Peaches	1/2 GAL. RD. CTM. 1 09
15 UNDS. CAR 75c	BORDEN'S NOVELTIES
Shurfine Creamy or Crunchy Peanut Butter	REG. 15" & 20" ALL VARIETIES EA. 10c
15 UNDS. CAR 79c	BORDEN'S DIPS or SOUR CREAM
Shurfine Bartlett Pear Halves	3 8 OZ. CTMS. 1 00
15 UNDS. CAR 79c	
Shurfine Pork & Beans	
15 UNDS. CAR 79c	
Shurfine Strawberry Preserves	
15 UNDS. CAR 79c	
Shurfine Early Harvest Sweet Peas	
15 UNDS. BOTTLE 79c	
Shurfine Pancake & Waffle Syrup	
15 UNDS. CAR 79c	
Shurfine Tomato Sauce	
15 UNDS. CAR 79c	
Shurfine Whole Peeled Tomatoes	
15 UNDS. CAR 79c	

FRIONA, TEXAS

460 Diners Enjoy Sausage

Some 460 persons enjoyed St. Ann's home-made sausage dinner, Sunday. Sausage lovers from all over the Panhandle and Curry County, N.M., ate generous portions of the mostly home-made dinner and then took sausage home with them.

Door prize winners were Peggy Baca of Friona, who received a set of dishes. A crock pot went to Ramon Carrillo of Bovina. Also of Bovina, Mrs. LouAnn Baumhardt, won decorative candle sticks; and, finally, Monty Linder of Slaton was the recipient of an electronic hand calculator.

Winner of the Bicentennial afghan was Fr. Dermot O'Brien of Amarillo.

Judy Brockman, chairperson for the dinner, wishes to thank all involved in its preparation and success and also the wonderful support of the members of our community.

Stone Completes Leadership School

Gary Stone of Route 3, Friona, has just completed the Conklin Leadership Preparation School in Minneapolis at the Sheraton Ritz Hotel.

They have been awarded the position of distributor in the Conklin organization.

Square Dancers Give House Warming Here

Friona Buttons and Bows Square Dance Club danced Saturday night, March 5 to the calling of Ed Gunnels of Clovis, New Mexico. The guest caller was Rex Williams of Friona.

Guests were Daryle and Bobbie Stephens of Clovis; Carlyle and Dorothy Sargent of Hereford; Dale and Rose Wright of Hereford; Glenn and Mary Hendrickson of Hereford.

Those visiting from Friona were Teddy and Sharon White, Floyd and Judy Schlenker and Carl and Velma



TERRI BINGHAM and **DOUG YOUNG**...Mr. and Mrs. John E. Bingham of Friona and Mr. and Mrs. J.W. Young of Garland announce the engagement and approaching marriage of their children, Teresa Lee and Douglas Alan. The couple will exchange

wedding vows on Saturday, May 21, at 1 p.m. in the First Baptist Church, Friona. Terri is a 1973 graduate of Friona High School and Doug is a 1973 graduate of South Garland High School. Both will graduate from Baylor University in May.

Jaycees Announce Tourney

The Muleshoe Jaycees announce the 14th Annual Volleyball Tournament to be held March 28 through April 2 at the Muleshoe High School Gym, as in the past.

Any team wishing to enter may contact Corkey Biggerstaff, P.O. Box 631, Muleshoe or phone 272-4266. All interested persons are invited to participate or attend. Deadline for entries is March 21. Entry fee for teams is \$10.00. There will be no charge for players at the door.

Schlenker. Following the dance members of Friona Buttons and Bows took refreshments to the home of Mr. and Mrs. Joe Bob Johnson for a housewarming party. The club presented Mr. and Mrs. Johnson with a money tree and gifts.

The next dance in Friona will be held on March 19. Lesson-takers dance on March 7 with Ed Gunnels as their caller.

89¢

Beltbuster SALE

Dairy Queen

A Beltbustin' Bargain!
Two juicy meat patties on a toasty golden bun. Lettuce, tomatoes, pickles, onions, mustard. The works! Beltbuster! Just 89¢.

WEDNESDAY THRU SUNDAY ONLY. MARCH 16 — 20
At participating stores.

\$1,000 FACTORY REBATE.

(through participating dealers)

Order a Zimmatic® quarter-section center pivot after February 15 take delivery by April 1—and Lindsay will give you a \$1,000 factory rebate. The offer is good only through participating Lindsay dealers and the number of Zimmatics that can be shipped by April 1 will be limited, so order now.

If your land is rough and rolling, order a Zimmatic 410, the hillclimber. The less expensive Zimmatic 307 will meet your needs if your land is level... it was the first successful long-span center pivot.

Whichever Zimmatic you choose, remember that the only thing being cut is your cost. You still get all of Zimmatic's idea-leading features. Like the Uni-Knuckle® and flex feature to ease stress on the line. Patented heavy-duty gearboxes, electric control panel with pivot and tower read-out meters and an external collector ring for dependable operation. Hot-dip galvanizing that adds years to the life of the system.

Under this program you can order a Zimmatic already adapted for the new Zimmatic Corner Pivot™... to be installed now or ordered and installed at a later date. The Zimmatic Corner Pivot allows you to irrigate 150 acres on a quarter-section and is available for immediate shipment in limited quantities.

This is a limited offer so act now and have a Zimmatic for this year. Save \$1,000... and maybe your crop. Come in and see us for further details on Lindsay's factory rebate program.

LINDSAY

BIG T

SPRINKLER SERVICE

Division Of BIG T PUMP CO.

FRIONA: Everett Gee - 247-3311
HEREFORD: Don Caillouet - 364-0353
DIMMITT: Rick Ward - 647-4171

Farm Equipment Auction

THURSDAY, March 17 10:00 A.M.

LOCATION: From Intersection of U. S. Highways 60 & 385 in Hereford, Texas, go 6 1/2 miles West on U. S. 60, cross railroad tracks, then go 1/2 mile East, and 1 mile South—
OR: from Summerfield, Texas, go 1 mile East, cross railroad tracks, then go 1/2 mile East and 1 mile South.

Lunch Will Be Available

<p>Tractors, Pickups, & Mobile Homes</p> <p>1973 1066 International Farmall diesel row crop tractor W/3493 hrs., International cab, air conditioning, radio, hydraulic clutch, front & rear weights.</p> <p>1967 706 International Farmall diesel row crop tractor W/3920 hrs., cab front & rear weights, duals</p> <p>1962 504 International Farmall diesel row crop tractor W/3466 hrs</p> <p>1975 Chevrolet Custom Deluxe 10, long wide pickup W/33,000 miles, V-8, Automatic, air conditioning, radio, headache rack, tool box, good rubber</p> <p>1969 Chevrolet C/10 short wide pickup, V-8 automatic, good rubber</p> <p>1974 Granville 12' x 60' Mobile Home, clean & neat</p> <p>8' x 35' Mobile Home</p> <p>Farm Equipment</p> <p>1— International 2 row shredder</p> <p>1— 6 row, 3 point Crust Buster (ring Roller)</p> <p>1— 14' Hoeme hydraulic Chisel Plow</p> <p>1— Model 314 International Moldboard W/cylinder</p> <p>1— Brillion drag type Clod Buster W/ hitch</p> <p>1— 9 Shank Hamby 3 point chisel plow W/ dual gauge wheels</p> <p>1— Shopmade drag type stalk cutter</p> <p>5— Miscellaneous harrow sections</p> <p>1— 4 row International Lister Planter W/fast hitch</p> <p>1— Hoeme chisel plow (Needing repair)</p> <p>1— Shopmade pipe bed roller</p>	<p>Farm Equipment — Continued</p> <p>1— 16-10" John Deere Van Brunt grain drill</p> <p>1— Pickup Fuel Tank</p> <p>1— 3 pt. Hamby Ditch Filler</p> <p>1— 6 row 30" cultivator W/shanks, hitch, 3 tool bars, coultter guides</p> <p>1— 707 Gyramor John Deere 4 row shredder</p> <p>1— Olsen Vine beater</p> <p>1— Five Star P.T.O. Post Hole Digger W/2 augers</p> <p>3— Assorted 2 1/4" tool bars</p> <p>1— Double tool bar onion lifter W/3 point hitch, high clearance shanks</p> <p>6— Shopmade row drags</p> <p>1— Set fast hitch/3 point adapters</p> <p>1— International rolling cultivator</p> <p>1— Double bar cultivator W/Hamby P.T.O. rod weeder</p> <p>5— Blackwelder Beet Thinners</p> <p>5— Blackwelder Beet Weeder tines</p> <p>1— Set dual tires for M Farmall</p> <p>1— Shopmade One Way</p> <p>1— Dempster Steel Wheel D.R.A. Drill</p> <p>1— Krause One Way</p> <p>1— Jacobson shopmade ditcher</p> <p>1— Green Spray Tank</p> <p>1— 2 bottom-14" Rollover Moldboard</p> <p>1— Double 1 1/4" tool bar W/hitch</p> <p>8— 295 International row planters & boxes</p> <p>1— 6 row John Deere bed shaper W/3 point hitch, triple tool bars, accessories</p> <p>1— Shopmade Vegetable Planter W/set Planter Jr. boxes</p> <p>1— Shopmade Vegetable Planter W/set Planter Jr. boxes</p>	<p>Farm Equipment — Continued</p> <p>1— Model 13226-2 Lockwood Potato digger</p> <p>1— Oliver Potato Digger</p> <p>1— 504 International 2 row belly cultivator</p> <p>1— Lever type drag Hoeme (needs repair)</p> <p>1— Triple tool bar 30" bed shaper</p> <p>30- 20' Joints 6" Aluminum gated pipe on 40" rows</p> <p>1— Lot irrigation tarps</p> <p>1— 6" steel irrigation stand pipe</p> <p>1— Lot assorted irrigation tubes</p> <p>3— Hydraulic cylinders</p> <p>1— Set new light duty gauge wheels</p> <p>1— Model 480 International tandem disc W/cylinder</p> <p>1— Big Rhino 6' all angle blade W/fast or 3 point hitch</p> <p>1— 2 section International harrow</p> <p>1— 5 row double tool bar lister W/gauge wheels, Cisco Hydraulic V-ditcher</p> <p>Shop Equipment & Miscellaneous</p> <p>1— 6" Van Dorn bench grinder</p> <p>1— Standard 6/12 Volt battery charger</p> <p>1— A-Frame on casters W/1 1/2 ton Yale hoist</p> <p>1— G.E. Electric Welder</p> <p>1— National Cutting/Welding Torch</p> <p>1— Speedaire Air Compressor W/large tank</p> <p>1— Lot electric fencing</p> <p>400 lbs. Pioneer Grain Sorghum seed</p> <p>5— Barrels assorted oil & barrel pumps</p> <p>Plus Many, Many Items Too Numerous To Mention</p>
---	---	---

Mrs. Eloyse P. Taylor — Owner
I have quit farming and will sell the above equipment with
No Minimums — No Reservations.

TERMS: CASH! All accounts to be settled sale day. All sales subject to state and local sales tax laws. Not responsible for theft or accident. Write or call auctioneers for additional information.

Arvell Williams, Auctioneers
TX GC-77-0234
6224 CANYON DRIVE — AMARILLO, TEXAS 79110 Phones, Ofc. 355-1012 — Res. 355-8592

Prairie Acres Party Line

By June Floyd

Hello Central:

Our Prairie Acres family is growing. Our newest resident is Mrs. Lora Sparkman of Hereford. Her husband, T.L. Sparkman Sr., has been with us for several weeks. The Sparkmans raised their family in the Summerfield Community.

Another new resident is Mrs. Eduvijas Campos from Odessa, Texas.

Mrs. Ethel Stone and Mrs. Nettie Rhinehart are currently roommates. One of Mrs. Rhinehart's daughters, Oleta Hagens of Pasadena, California, was a recent visitor.

Our premises have been brightened with colorful plaid shirts and blouses worn by our employees.

We appreciate so very much the large basket of fresh fruit which was brought to us by members of Friona Young Homemakers recently. We're also grateful to Katy Osborn for her many visits and the candy and other goodies she brings with her.

Debbie Shirley, who is our activity director, needs some simple craft ideas and also some volunteer workers to help with the projects. It would be a good idea to contact Debbie for more details.



PROUD ADDITIONS....Zeldia Donaldson Ellison of Dimmitt, a Bovina High School graduate, proudly displays her new daughter, Tiffany Denise, who was born on the same

day that her record album, "I Know the Feelings," was issued. Mrs. Ellison is a 1968 graduate of BHS. Her album is available through Carrol's Printing in Friona.

Bovina Woman Has Two New Additions

Mr. and Mrs. Terry Ellison of Dimmitt are a proud and happy couple these days.

The former Zeldia Donaldson of Bovina, Mrs. Ellison gave birth to a daughter on February 14 and on that same day received the first copies of an album she started in November and completed in December.

"My husband joked about the baby and the records arriving on the same day, and sure enough, they did—on Valentine's Day," she exclaimed.

The baby, Tiffany Denise, weighed seven pounds, four ounces and was eighteen inches long.

The maternal grandmother, Mrs. Sterling Donaldson of the Oklahoma Lane Community, taught school in

Bovina for a number of years and Mrs. Ellison graduated from Bovina High School in 1968.

Her new album, "I Know the Feelings," is now on sale at Carrol's Printing in Friona.

The Ellisons moved to Dimmitt in 1971 after she graduated from Hardin-Simmons University in Abilene. Prior to taking a maternity leave, Mrs. Ellison taught seventh and eighth grade English and eighth grade typing in the Dimmitt School. Mr. Ellison is Vocational Adjustment Coordinator under Plan A with the Dimmitt Schools.

"I have always liked to sing, but it was always just for fun," Mrs. Ellison said. "My two sisters and I used to sing trios for church, and

then recently my students started asking me to sing for their banquets and things."

She explained that some of her friends liked her rendition of the increasingly popular song, "One Day At A Time," and encouraged her to record it.

"So, I decided I might as well make a whole album," she said. "Terry was so thrilled when the record came out. He has stood behind me all the way."

The Ellisons had 1,000 records made. The album has been played by several area radio stations. Mrs. Ellison has already had an offer to make a religious album, but says she will have to think about that for awhile.

Second Quarter Jr. High Honor Roll Released By Principal

Twenty-nine students were named to the second quarter All A honor roll released this week by Cecil Maddox, principal of Friona Junior High School.

Students making All A's were:

Eighth Grade—Cindy Alexander, Susan Anderson, Scott Butler, Kipi Fleming, Margaret Ramirez, Dana Smith and Dianna Wright.

Seventh Grade—Kim Barnett, Andy Fleming, Sunny Horton, Bonnie Lunday, Jim Mabry, Amber Smith, Sandy Spring and Penni Weatherly.

Sixth Grade—Patty Hinton, Carl Jackson and Martin Lopez.

Fifth Grade—Kristi Britting, Kevin Brogden, Ruben Castaneda, Diane Johnston, Karen Lloyd, Tonya McPherson, Jessica Maurer, Paul Melton, Tommy Rodriquez, Jo Schueler and Sonia Sells.

Making A's with one B were:

Eighth Grade—Kelly Caudill, Terri

Lloyd, Chris Lyons, Rick Roden, Lilia Rodriguez and Mike Schueler.

Seventh Grade—Angie Castaneda, Stanley Ellis, Tawnya Hand, Trent Johnson, Gwendolyn Maurer, Jay Norsworthy, Greg O'Brian and Shawn Osborn.

Sixth Grade—Dennis Conway, Cindy Drake, Bill Head, Judy McLellan and Mark Montoya.

Fifth Grade—Kim Carthel and Valencia Koelzer.

Having A's and two B's were:

Eighth Grade—Norma Barlow, Lynn Blackburn, Tim Mercer, Monique Osborn, Edie Owen, Pam Perez, Sydonia Tongate and Myra Veazey.

Seventh Grade—Christy Benge, Lesa Bermea, Cari Hand, Teresa Loflin, Rene Noland and Brenda Serright.

Sixth Grade—Jay Hight, Joey Howard, Vincent Koelzer and Scott

McMillan.

Fifth Grade—Doug Carthel, Matthew Loftis, Johnny McLellan, Stephen Newell and Joe Zachary.

ERA Opponent

To Speak Here

A meeting is scheduled in Friona next Tuesday, March 15 by Pat Vogler of Hereford, who will be speaking in opposition to the ERA (Equal Rights Amendment).

The meeting is scheduled to be held at First Baptist Church, beginning at 9:30 a.m. at the Fellowship Hall.

A spokesman for Mrs. Vogler said that the public was invited to attend the meeting.



Member



814 Washington
Friona, Texas

Ph. (806) 247-2116

ANNOUNCING ... FRIONA FOTOS

Parmer County's Newest Professional Photography Studio

FEATURING:

- GROUP & INDIVIDUAL PORTRAITS
- PASSPORT PHOTOS
- WEDDING & ANNIVERSARY CANDIDS
- ALL TYPES COMMERCIAL & INDUSTRIAL PHOTOGRAPHY
- BROCHURES & POSTERS
- FILM PROCESSING COLOR, B & W, & MOVIE FILM
- BY FOX PHOTO

"We Want To Serve All Of Friona's Photographic Needs"



23rd ANNUAL MEETING NOTICE OF WEST TEXAS RURAL TELEPHONE COOPERATIVE, INC.



**THURSDAY,
MARCH 17, 1977
7:00 P.M.
BULL BARN
HEREFORD, TEXAS**

- ★ THREE DIRECTORS TO BE ELECTED
- ★ REGISTRATION BEGINS AT 6:00 p.m.
- ★ FREE SUPPER SERVED FROM 6 TO 7 p.m.
- ★ DOOR PRIZES
- ★ ALL MEMBERS ARE URGED TO ATTEND.

WEST TEXAS RURAL TELEPHONE COOPERATIVE INC.

Town Talk

By June Floyd

Phone 247-3681

With Your News Item



Mr. and Mrs. Ernest Anthony and Mr. and Mrs. A.W. Anthony Sr. returned home recently after an extended visit with relatives and friends in Texas and Louisiana.

They were guests in the home of Mrs. S.R. Holden, who is Mrs. A.W. Anthony's sister, at Lake Charles, Louisiana, several days.

Several Frionans have been in and out of Amarillo hospitals recently.

Doyle Cummings was hospitalized a day or two following an automobile accident, but has been home several days.

Russell Varner had surgery at St. Anthony's Thursday of last week and was dismissed and came home Wednesday. Stella reports that he is doing fine.

June Spring is a surgical patient at High Plains Baptist Hospital and is reportedly making satisfactory progress. Susie, who lives in San Antonio, has been here with Dr. Paul and Johnny and in Amarillo with her mother for several days and plans to stay awhile longer before returning to the Alamo City.

Bob Riethmayer is home from Lubbock Methodist Hospital, where he spent several days undergoing tests. He has a few autographs on the cast on his leg and is able to be up and around.

Kenneth Gaines, son of Mr. and Mrs. Alvin Gaines and a student at

Wayland Baptist College, Plainview, had surgery at Central Plains Hospital there one day last week.

At the present time he is at home, but will be admitted to the hospital Sunday afternoon for more surgery.

Efforts are being made to compile a Fannin County history book. The project is being sponsored by the Bonham Public Library.

No doubt, this history book will contain names of many Farmer County residents.

In a recent issue of the Leonard Graphic an article appeared about the family of United States Congressman Dale Milford of the 24th District of Texas.

Congressman Milford, a former student of the late Sam Rayburn, who taught at a one room school in Dial. Apparently growing up in Fannin County and attending a one room school proved to be a good base for a political career.

He claims Bug Tussle as his birthplace and reports that he was born on a kitchen table of a little farmhouse between Bug Tussle and Dial.

When asked by his colleagues about the location of his birthplace, he replies, "It's 8 miles north of Sweatbox or 13 miles northeast of Chigger Ridge or 12 miles northwest of Muddig."

The congressman further reports, "We lived next to the schoolyard and

everyday I'd play with all the kids when they came out for recess. One day when I was five I went in with them and just started going to school."

Those of us who enjoy reports of general mercantile stores, horse and buggy days and such like should contact the Bonham Public Library and get our names on the list of purchasers of the history book.

Monday afternoon while we were visiting a brother and sister-in-law, who live on a ranch near Texline, we went riding in a genuine horse drawn cart pulled by a real live Welch pony named Ginger.

The horse, harness and reins were very much like the ones we used as transportation to and from a one room country school at Levy, New Mexico more than 50 years ago.

About the only likeness the cart had to the one we remember best was that it had a singletree and two shafts. The seat, which had been removed from a car, was padded and upholstered with naugahyde and the tires were rubber.

The temperature was in the upper 60's, there wasn't any wind and the ride was delightful. A heavy laprobe of wool, which was standard equipment for a 1920 cart in Northern New Mexico, wasn't needed.

Another delightful weekend experience was attending 4-H Club District Contests at Hugoton, Kansas. Our number two grandson, Jason Floyd, participated in the contests. (We number all our children and grandchildren in the order they came into the family.)

There were probably 150-200 4-H Club members of all ages from five counties competing in various categories and the majority of them were serious minded young people who had a job to do and were willing and eager to do it.

The singing, speaking, project demonstrations, model meetings and instrumentals, were all we had time to see and we didn't see all of them.

However, as I watched the participants and their leaders working together, I was reminded that here was a side of young America that we rarely see on television or hear on radio.

Maybe we should spend more time

reading our newspapers and keeping up with such organizations and supporting them.

Linda and Eric Rushing, Jo and Rick Luther and Joy and Robbie Osborn are home after spending a week attending the Institute of Basic Youth Conflicts seminar in Fort Worth.

Make the most of yourself for that is all there is of you.

Hospital Report

ADMISSIONS--
Sam Aldridge, Farwell; Brandon Polk, Friona; J.C. Pewitt, Farwell; Olga Cantu, Hereford; Beulah Jarrell, Friona; Jeffrey Dickson, Friona; Floyd Millican, Friona; Cecil Coker, Hereford; Eva Mejia and baby girl, Black; Kathy Esparza, Texico; Gwen Corn and baby girl, Friona; Eugenia Hood, Earth; David Lynn Spencer, Friona; Jean Ann Wilkins, Farwell; Fredrico Segovia, Bovina; Joyce Wedmier, Friona; Alice Lara and baby girl, Bovina; and Charles Ross, Bovina.

Brandon Polk, Julia Ann Moody, Linda Cord, Rosa Saucedo and baby girl, Beulah Jarrell, Sharon Spinhirne and baby boy, Sam Aldridge, Deke Kendrick, Fredrico Segovia, Cecil Coker, Helen Ward, J.C. Pewitt, Jeffrey Dickson, Kathy Esparza, Jean Ann Wilkins, Joyce Wedmier, Floyd Millican, Gwen Corn and baby girl, Leandra Aragon, Olga Cantu, Eunice Horner, Eva Mejia and baby girl and Jeriah Spencer.

DISMISSALS--
Weldon Peace, Andy Wilson,

PATIENTS IN HOSPITAL--
Eugenia Hood, Henry Ivy, Charles Ross and Alice Lara and baby girl.

FHA Chapter Has Various Activities

The Friona Future Homemakers of America held an election for the new officers for the school year 1977-78. This election was held on February 9.

The new officers are Rolanda Hudson, president; Varla Welch, first vice president; Mindy Moseley, second vice president; Faith Mays, third vice president; Robin Zetsche, fourth vice president; Vanessa Hudson, fifth vice president; Sylvia Malouf, secretary; Kim Frye, treasurer; M'Lynda London, parliamentarian and Vickie Smiley, historian.

The FHA also hosted a Sweetheart

Party on Valentine's Day with the Future Farmers of America. Chairman of this party was Julie Owen.

A program was hosted by the FHA and FTA on defensive action by women on March 10 at the Friona High School. Tony Guess from the Department of Public Safety in Amarillo demonstrated these actions. This program was very informative to all of the Friona High School girls.

The next scheduled event for FHA is the Area Meeting in Lubbock on March 12.

IRRIGATE YOUR WIDE OPEN SPACES WITH OUR 360 THRIFTY-RAIN PIVOTAL SPRINKLER SYSTEM.

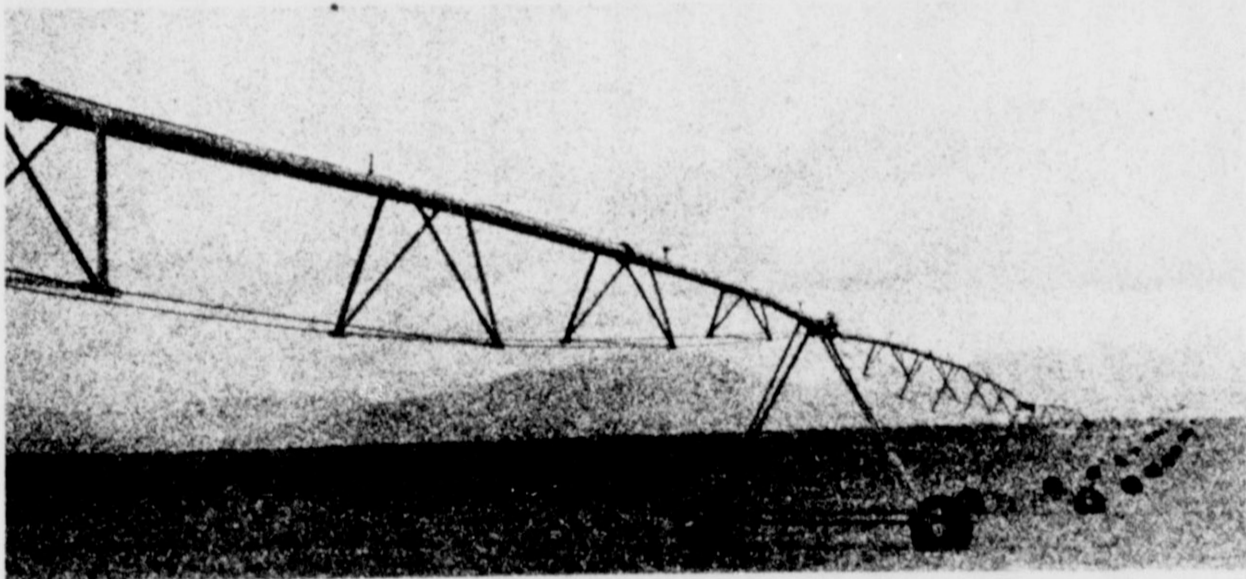

If you have relatively level land, and you've been putting off buying an electric-drive pivotal system because of price, we've got just what you've been waiting for. The new Gifford-Hill 360 Thrifty-Rain™

Finally, there's an electric-drive system that's within the budget reach of farmers who would ordinarily buy either hydraulic or water-drive systems. The 360 Thrifty-Rain™ is a "long span" version of our classic 360. The basic difference being the distance between towers (164 ft. on the Thrifty-Rain™ 124 ft. on the standard 360).

The 360 Thrifty-Rain™ 164 ft.

The standard 360 124 ft.

By using longer spans, we reduced the number of towers necessary to cover the same

acreage. That means less cost to manufacture. And less cost to you!

The 360 Thrifty-Rain™ is also equipped with heavy duty drive systems. Both the original 360 and the 360 Thrifty-Rain™ feature a unique computer-designed sprinkler head spacing and nozzleing concept that provides uniform water distribution and reduced pumping costs. Both systems use heavy-walled 6" O.D. pipe for extra strength.

Consequently, the 360 Thrifty-Rain™ is structurally stronger than other "long span" systems on the market today. It operates efficiently even under high wind conditions, and can handle up to 10% grades.

Standard 360 spans are interchangeable with 360 Thrifty-Rain™ spans. That means you can use standard spans to allow flexibility of tower location and accommodate special terrain problems.

So if you've got wide open spaces to irrigate, and you don't want to pay for capabilities you don't need, get a Gifford-Hill 360 Thrifty-Rain™. And save yourself some money to boot.

WESTERN AG SALES CO., INC.

Friona

Contact Ken Cole

806 481-3316



energy with a conservationist electric water heater

Maximum efficiency in appliances is what we're all looking for... to save energy, save money.

That's why the CONSERVATIONIST ELECTRIC water heater is worth looking at. It saves 15% of the energy used in a like-sized regular electric water heater and delivers all the dependability of electric water heating. The Conservationist is heavily insulated on all sides so heat is retained inside the water heater... used for what you're paying for... to heat water.

And, you save on space above the heater because an electric water heater does not need a flue or vent.

Ask us about the Conservationist... the electric water heater designed to use energy wisely and save.

WE SELL 'EM... CALL US

THE ELECTRIC COMPANY

Get Johnny Rutherford's \$3.00 REFUND*

WINNERS CIRCLE CARQUEST

1974 & 1976 INDY 500 WINNER

When you buy 5 qts. of VALVOLINE motor oil and an AC oil filter. (at our regular low prices.)

*Pick up a \$3 refund coupon when you buy your oil and filter. Mail it, along with your sales slip and filter box top to Johnny Rutherford. He'll send you his check for \$2, plus a certificate redeemable for \$1 on any purchase at your CARQUEST store. Limit one refund per customer, please.

CHALLENGER 10-PIECE SOCKET SET 1/4" drive spinner, 9 sockets, metal case. Individual price value, \$17.10. SPECIAL \$8.54	K-D PUNCH & CHISEL SET Drop forged, nickel-chrome finish, vinyl pouch, 2 chisels, 3 punches, mechanic's quality. SPECIAL \$9.95	GATES CAR HEATER HOSE Specially packaged in 6-ft. lengths 1/2" 3/4" 1" sizes. Buy hose at low price now and save for emergency. ONLY \$1.59 EA.	WINDSHIELD WASHER SOLVENT Cleans grime, film, bugs, from windshields when water won't. For all washers. Reg. 95¢. NOW ONLY 59¢
CHAMP OIL CHANGE KIT Professional quality filter wrench, pour spout, drain pan. Reg. \$7.66. NOW ONLY \$4.39	The Bargain Box Filter Wrench \$1.45 Wire Brush \$1.12 Oil Spout \$1.32 Wheel Brush \$2.00 Rally Car Wax \$3.15 VW Drain Pan Wrench \$6.99 Engine Cleaner \$1.90 K & W Carb Cleaner \$1.19 Go-Jo Hand Cleaner \$1.12 Mechanics Creeper \$9.99 KarCheck Dwell Meter \$19.20 CARQUEST Fender Cover \$4.59		

Good at CARQUEST Auto Parts Stores and participating dealers thru March 26, 1977

WELCH AUTO SUPPLY

Friona, Texas

W. Hwy. 60 Ph. 247-2747

"WE KNOW WHAT YOU MEAN WHEN YOU'RE TALKING PARTS."

ASSISTANT MANAGER'S SALE

"WHEN YOUR NAME IS PIGGLY WIGGLY, YOU JUST GOTTA SMILE."



CLIP AND SAVE



BOB JOHNSON
ASS. MANAGER
FRYERS
USDA INSP.
WHOLE TWIN PACK
LB. **44¢**



However You Slice It...
Piggly Wiggly
Doesn't Take A Whack Outta' Your Budget!

7-UP FLOAT
32 OZ. BOTTLE 7-UP (PLUS DEPOSIT) PLUS PINT SHURFRESH ICE CREAM FOR ONLY **10¢** (WITH COUPON) LIMIT 1 PER FAMILY



HORMEL SUPER SELECT PORK CHOPS
LB. **\$1.09**
¼ PORK LOIN 9-11 CHOPS

SHURFRESH PORK SAUSAGE
1 LB. BAG
2 LB. BAG \$1.77 **89¢**



EGGS
GRADE A MEDIUM
DOZEN **69¢**

OPEN DAILY HI 9:00
DOUBLE S&H GREEN STAMPS ON WED

KRAFT AMERICAN SINGLES 12 OZ. PKG. **\$1.09**
SLICED CHEESE
GLOVES
HOT LINKS LB. **79¢**

HORMEL SUPER SELECT LB. **\$1.59**
PORK CHOPS Center Cut
USDA CHOICE BEEF LB. **99¢**
STEW MEAT Lean Cubes Of Beef

CLARDY'S
SOUR CREAM 8 OZ. **3/\$1**
COTTAGE CHEESE 12 OZ. **59¢**
GR. CHILI DIP 8 OZ. **3/\$1**

LIPTON INSTANT **TEA**
3 OZ. **\$1.39**

AUSTEX **CHILI**
24 OZ. CAN WITH BEANS **79¢**

7-UP
6-32 OZ. BOTTLES **\$1.49**

JELL-O
ASSORTED FLAVORS **5/\$1**

PLAY JACKPOT AND WIN \$300.00

SHURFINE ASSORTED **CANNED POP**
12 OZ. CANS **7 FOR \$1**

WHITE DEC. **GALA TOWELS**
JUMBO ROLL **59¢**

POT PIES
MORTON'S FROZEN CHICKEN TURKEY BEEF **4 FOR \$1**

ISLAND GOLD CRUSHED **PINEAPPLE**
300 Can **39¢**
SHURFINE Old Fash. Veg. Cream Of Potato Cream Of Celery **SOUP** **6/\$1**

SATHERS ASSORTED **COOKIES** FLAVORS **3/\$1**
SUE BEE **HONEY** 24 OZ. **\$1.49**

SATHERS 15 OZ. ASST. **EASTER EGGS** **88¢**
LIQUID DETERGENT **DOVE** 22 OZ. **79¢**

ROSE MILK 12 OZ. **\$1.49**
SKIN CARE REG. **\$2.39**
ROSE MILK 8 OZ. **\$1.19**
SKIN CARE REG. **\$1.89**



LETTUCE
CALIF. LARGE FIRM HEAD EACH **39¢**

TEXAS ORANGES
LB. BAG **79¢**

CAL 70'S AVOCADOS
5 FOR **\$1**

WASH. D'ANJOU PEARS
3 LB. BAG **79¢**



**WHITES
AUTO**

SPECTACULAR

SALE PRICES GOOD NOW THRU MARCH 19, 1977

2 HP MINI-TILLER

MEET THE MINI-TILLER. 2 HP Briggs & Stratton engine makes quick work of hard soil! Unbreakable steel tines till 15" wide and up to 6" deep! Rugged chain drive transmission. Weighs only 62 lbs. 87-52

\$147



AMMONIUM SULFATE

Time tested all purpose fertilizer for thick, green lawns & healthy plants and shrubs! 84-512

2⁹⁹
50 Lb. Bag.

20" ROTARY PUSH MOWER

Easy pull starting! Big 3 HP Briggs & Stratton engine to handle high, dense grass! 4 position cutting height adjustment. 87-259

\$87



YOUR CHOICE SHOVEL or CULTIVATOR

Regular \$3.98 values! Fine quality implements of carbon steel with sanded wood handles! 85-22, 145

2⁹⁹ EA.

CHARCOAL

10 Lb.

99^c



83-285

LAWN CHAIR

4⁴⁷

83-5

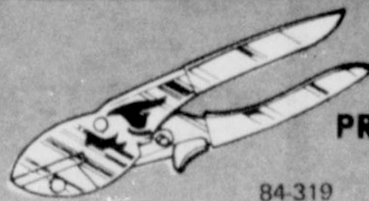

PRUNER

84-319

1⁵⁷



Coleman FUEL

Stock up now for spring camping & fishing! 64-5925

FUEL

1⁵⁷
Gal.

**Whites
has it!**

A COMPLETE SELECTION OF AUTOMOTIVE, TV APPLIANCES, FURNITURE & LAWN & GARDEN VALUES

- SPORTING GOODS
- HARDWARE
- HOUSEWARES and GIFTS
- TIRES and BATTERIES
- AUTOMOTIVE SERVICE
- CONVENIENT TERMS

**WHITES
AUTO**

SPECTACULAR

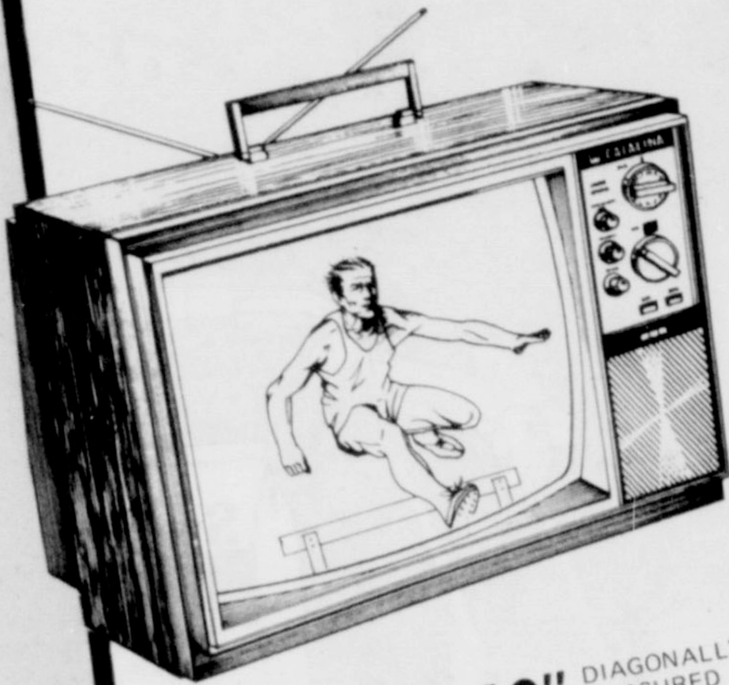

**CATALINA 19" DIAGONALLY
COLOR TV**

Just GREAT COLOR, and, after all, that's why you buy it! Pushbutton color tuning with efficient solid state circuitry! Sturdy carrying handle and built-in antennas. 122-6183

\$348



**19" DIAGONALLY
MEASURED
B & W TV**

Memory VHF fine tuning for crisp, clean pictures! 100% solid state, with VHF & UHF antennas, carrying handle. 122-7519

134⁸⁸



12 Blank Tapes
Free!!

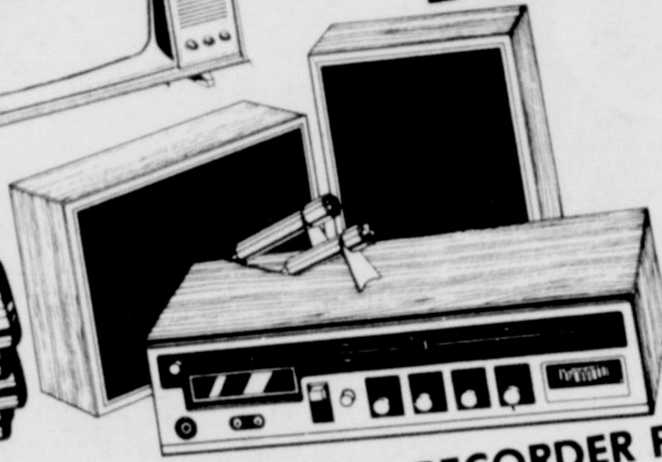

AM/FM 8-TRACK RECORDER PLAYER

THE SOUND FACTORY! Records in living stereo from records, 8 track tapes, cassettes, reel-to-reel, radio or live! Phonograph, auxiliary & headphone jacks give it extra versatility! Dynamic wide-range 5" speakers. Free blank tapes to get you started! 123-5334, 124-890

\$127

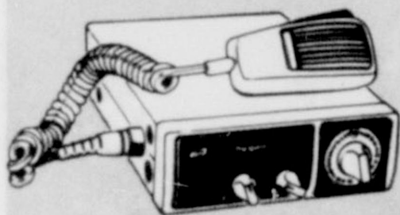

**40 CHANNEL
CB RADIO**

Hy Gain craftsmanship with full 40 channel operation! 16-1102

\$117

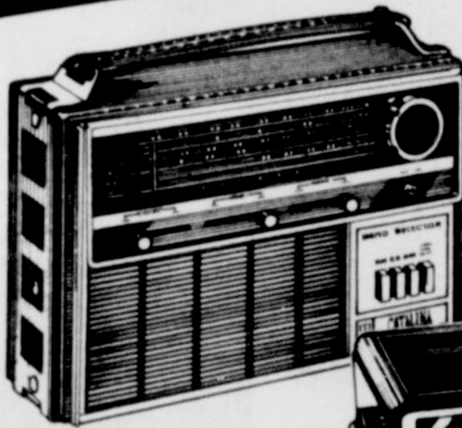

MULTI-BAND RADIO

BUY NOW and save \$12.00! Pulls in AM, FM, Police, aircraft in flight, CB bands plus logging scale & separate weather tuning! Uses batteries or house current. Earphone & carrying strap included. 120-6245

36⁷⁷

**AM/FM CLOCK
RADIO**

Dependably accurate time!
Wake to music or alarm!
Solid state. Wood-grain finish!
120-6150

24⁷⁷

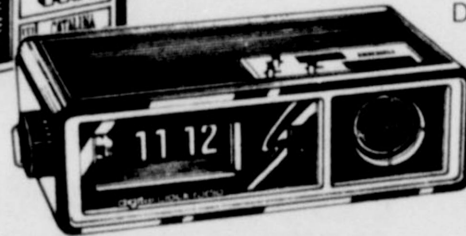

CASSETTE RECORDER

COMPACT!
SOLID STATE!
Built-in mike.
Batteries included. 123-6300

24⁷⁷



8-TRACK AUTO STEREO

Something NEW! A program selector lets you choose & repeat the program you want to hear! 16-565

44⁷⁷

AUTO STEREO SPEAKER

5-1/4" high density wedge type with mounting hardware and installation instructions! 16-380

8⁷⁷
Pr.

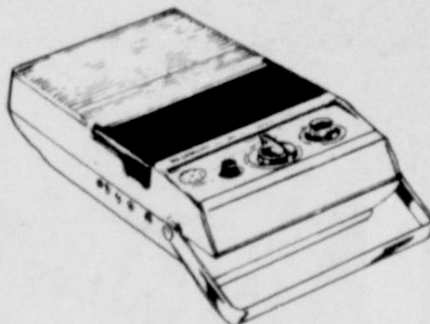
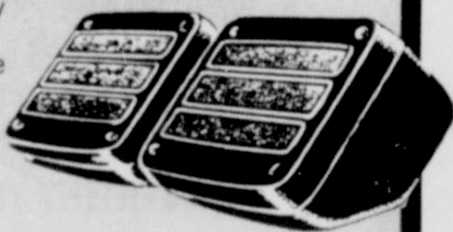

**PORTABLE
AM/FM RADIO**

Smartly styled shock resistant cabinet! Solid state with full range speaker! Includes earphones. 120-6216

9⁸⁸

Bassett®



3 Pc. BEDROOM
DRESSER, MIRROR & BED

NITE STAND \$69
220-9640

Reg. \$359.95
\$299

Distinctive early american maple finishes by BASSETT! Micarta high pressure laminated tops are stain & mar resistant. 220-9620,5,10



4-DRAWER CHEST
220-9634 **\$129**



KROEHLER SOFA and CHAIR

CENTURIAN. Durable flame stitched Herculon cover and solid Oak and Brass trim. 732-6810,20
Reg. \$519.00

\$449

MATCHING LOVE SEAT

\$239

732-6850

ROYAL QUILT BEDDING

You spend one-third of your life in bed! Enjoy it more with the restful sleep you'll get from this full size coil innerspring mattress with famous POSTUREFLEX construction. Matching box spring foundation. 222-3120, 30

YOUR CHOICE MATTRESS or BOX SPRINGS **\$66** EACH

MATTRESS or BOX SPRINGS

High quality twin size mattress and box spring set that will provide years of solid comfort! Famous POSTUREFLEX construction gives you firm support so you feel refreshed the next morning! 222-3140, 50

\$55 EACH

YOUR CHOICE NOW

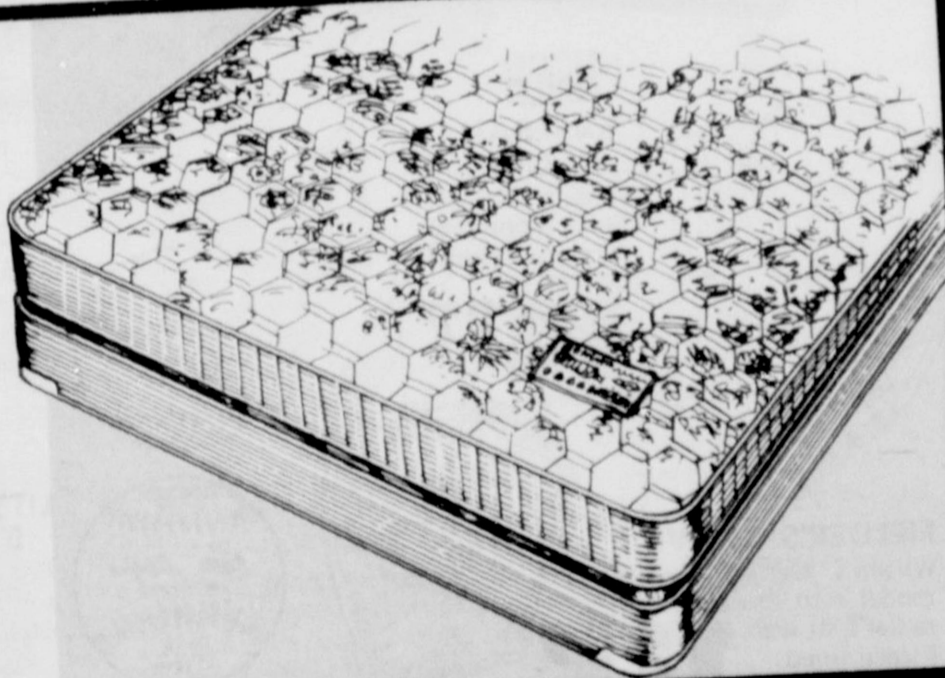

WHITES AUTO

WHITES HAS IT FOR OUTDOOR FUN

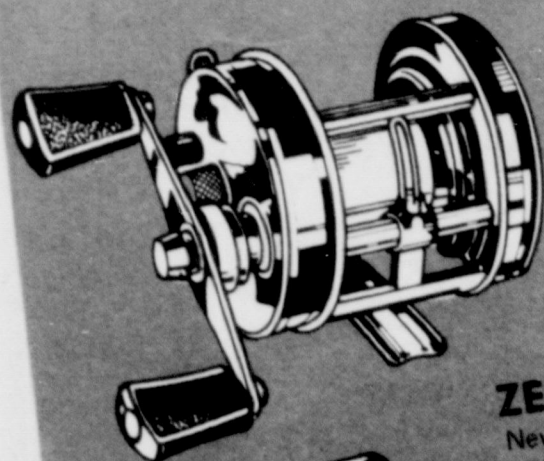

5000D REEL
FOR THE PERFECTIONIST! Centrifugal and mechanical brakes for precise backlash control! Powerful star drag. 130 yd. line. 60-146

27⁷⁷

3200 REEL
Precision steel ball bearings and helical gears! Centrifugal drag system! 60-152

27⁷⁷

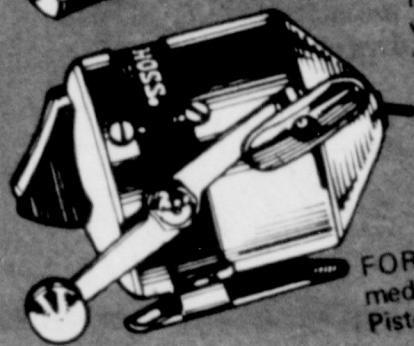
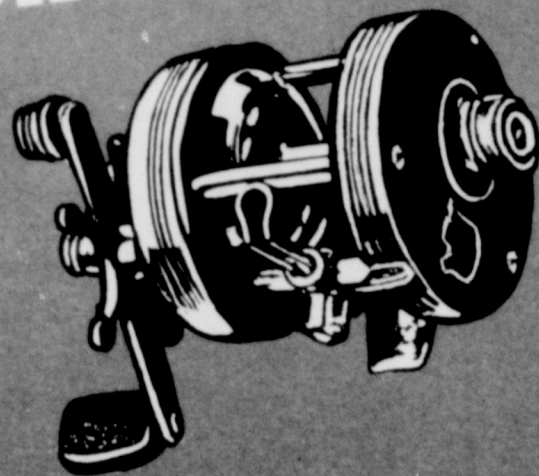

ZEBCO HOSS
New neavy duty fresh water reel with stainless steel 22-point spinner-head! 60-284

10⁹⁹



ZEBCO ROD & REEL SET
WHITES HAS IT... A package deal with 202 reel loaded with 6 lb. line & 2 pc. 5'3" fiberglass rod! 60-1022

7⁴⁴

LEW'S BEAR STICK
FOR ACTION ANGLERS... featuring a sensitive 6' medium action blank with 5 ceramic guides tip top. Pistol grip handle. 60-876-878

12⁸⁸

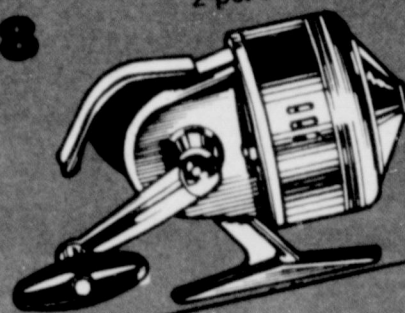

St. CROIX REEL
60-274

7⁷⁷

LEW'S SPEED STICK
5'6" super sensitive sanded medium action blank with 6 diamond hard fugi guides & tip top! Live action pistol grip handles! 60-881-2

19⁹⁷

St. Croix 5 1/2' or 6' ROD
WHITES HAS IT... bait or spin casting rods with medium action transglas blanks, 3 chrome plated guides and tip, species cork handles! 60-690, 4

9⁴⁴

HUTCH BASEBALL GLOVE

Regular \$16.95!
Snap action pre-formed pockets!
64-4788, 92

14⁷⁷

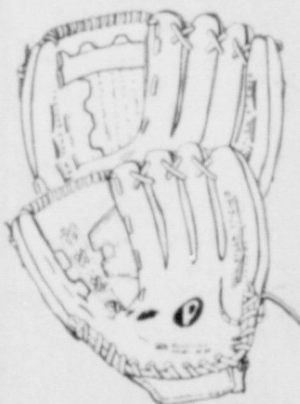

FIELDER'S GLOVE
Wilson's "Catfish" Hunter model with new closed radial split web. Fleece lined. 64-4777

11⁹⁹

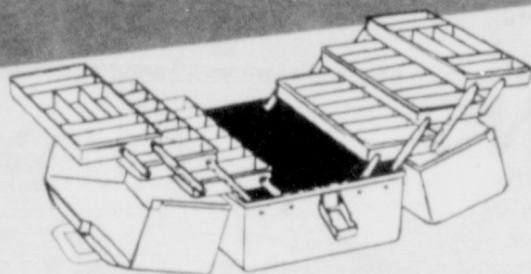
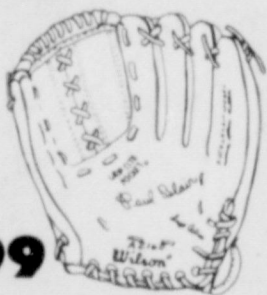

SIX TRAY TACKLE BOX

13⁹⁹

Keep your baits neatly arranged in 30 assorted size trays! Rain tight, rust proof & heavy duty! 62-1188

OFFICIAL BASEBALL

Durized construction with special sealed cover. 64-4680

1³⁷



LITTLE LEAGUE BASEBALL

For regular season or tournament play! 64-4692

2³⁷



ALL SPORT SHOES

4⁹⁹

Tough, sporty, stylish! For football, baseball, soccer! Mens & boys sizes. Outfit the good sports in your family and save \$1.00 a pair! 64-5700-45

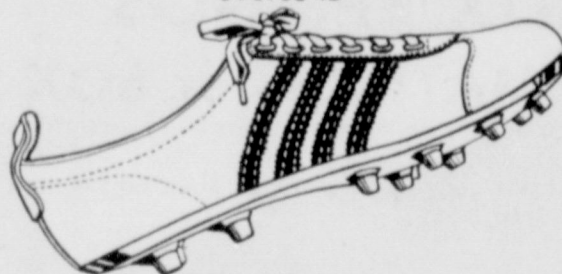

UN!

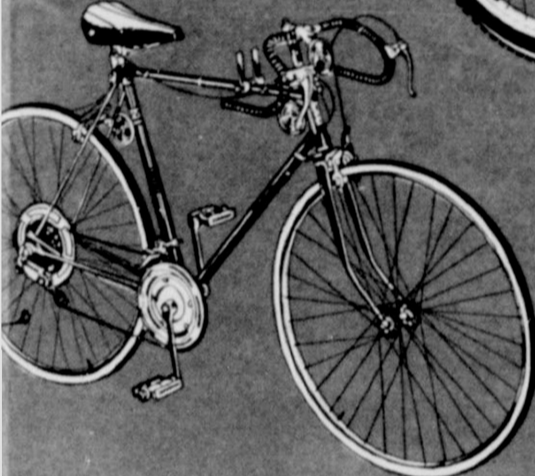
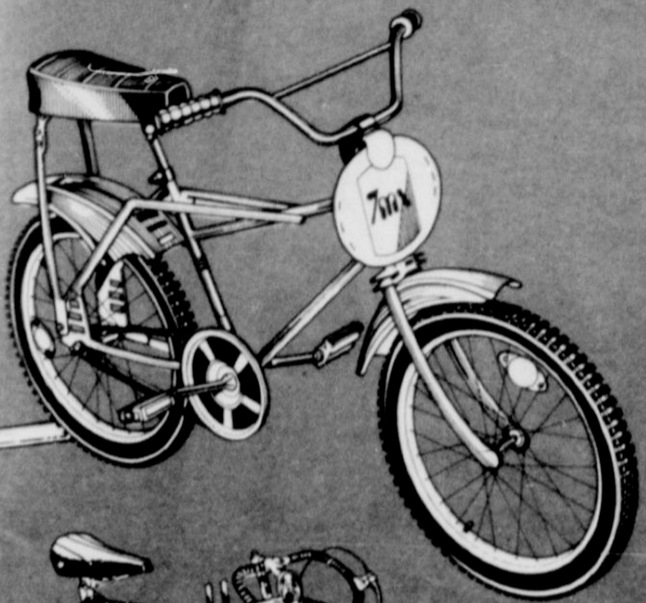

10-SPEED BICYCLE or MOTOCROSS BICYCLE

WHITES HAS IT! A super bike special for you! Deluxe 26" 10-speed or an authentic motocross bike. 67-212

69⁹⁷
In The Carton

GYM-DANDY.

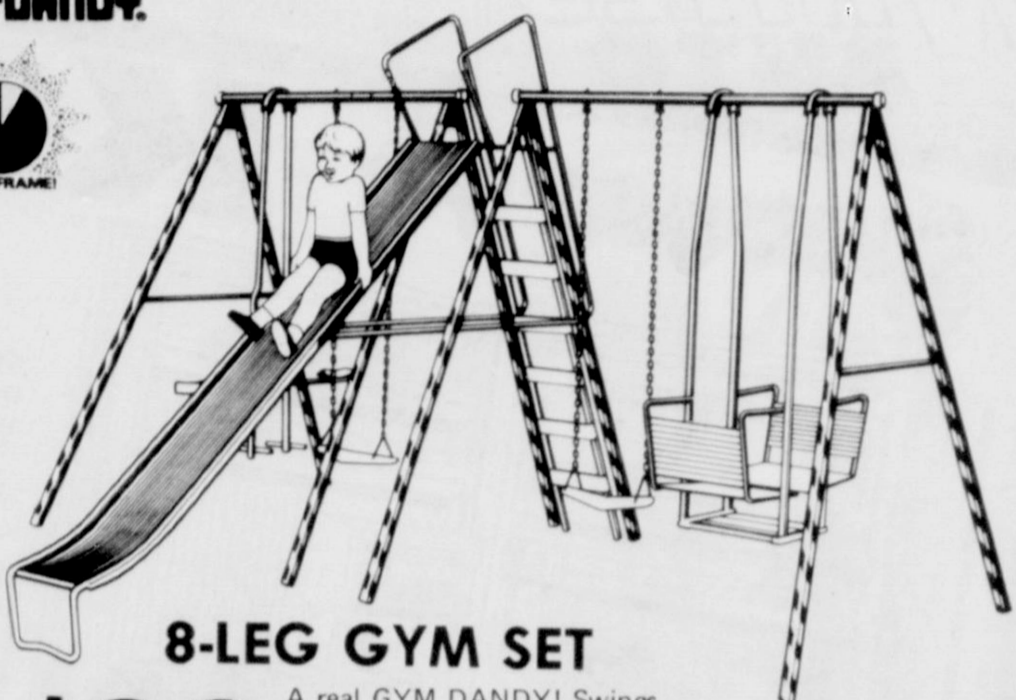

8-LEG GYM SET

\$88
In The Carton

A real GYM DANDY! Swings 'n things to give your growing youngsters fun, sun & recreation! 11 ft. big slide, 2 swings, sky scooter and 2 seat lawn swing. Heavy 2" tubular frame for safety. 66-321

POCKET CALCULATOR

Save \$3! The APF Mark 75 adds, subtracts, multiplies, divides, figures percentages, even has an accumulating memory & algebraic logic! 9 volt battery included.

10⁸⁸

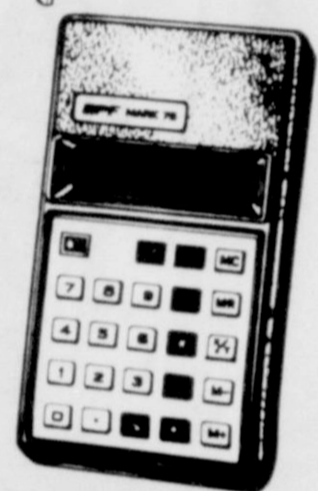

EASY WIPES
They're REUSABLE!
271-4000

2 FOR 77^c

AstroTurf DOOR MAT



3⁷⁷

Grassy Astro-Turf won't mildew or shed! Use indoors, outdoors! 72-174



DELUXE UTILITY FILE CHEST

Stop misplacing those important papers, bill receipts, sales tickets! Keep them safe & at your fingertips in this steel cabinet with lid! 271-4068

14⁸⁸

Big Savings On Bike Accessories!

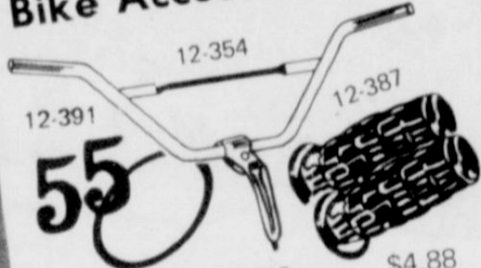

55

MX HANDLEBARS \$4.88
HANDLEBAR GRIPS 77c
MOTOCROSS NUMBERS 88c



MX SADDLE \$6.99
MX FENDERS 77c
CRASH PAD 99c

12-389

YOUR CHOICE!

2 FOR \$1

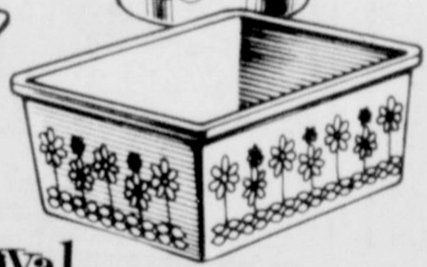
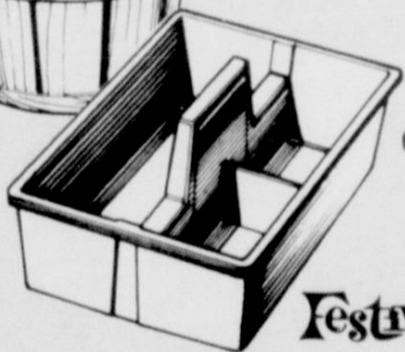

Festival

WASTE BASKET, PAIL, CARRY-ALL or DISH PAN

MIX 'EM, MATCH 'EM, or save even more — Go a little wild and buy all four! Colorful wastebaskets, dishpans, all-purpose pails & carry-alls in heavy duty plastic — built tough to take it. WHITES HAS IT... for your home!
72-620, 5, 7-634, 6, 8-641, 2-652, 4, 6

19⁸⁸

UNFINISHED CHEST

Forest fresh ponderosa pine ready for your personal touch! Spacious 13 x 21 x 32. 76-2000

**WHITES
AUTO**

SPECTACULAR

KELVINATOR

**13 Cubic Foot
REFRIGERATOR**

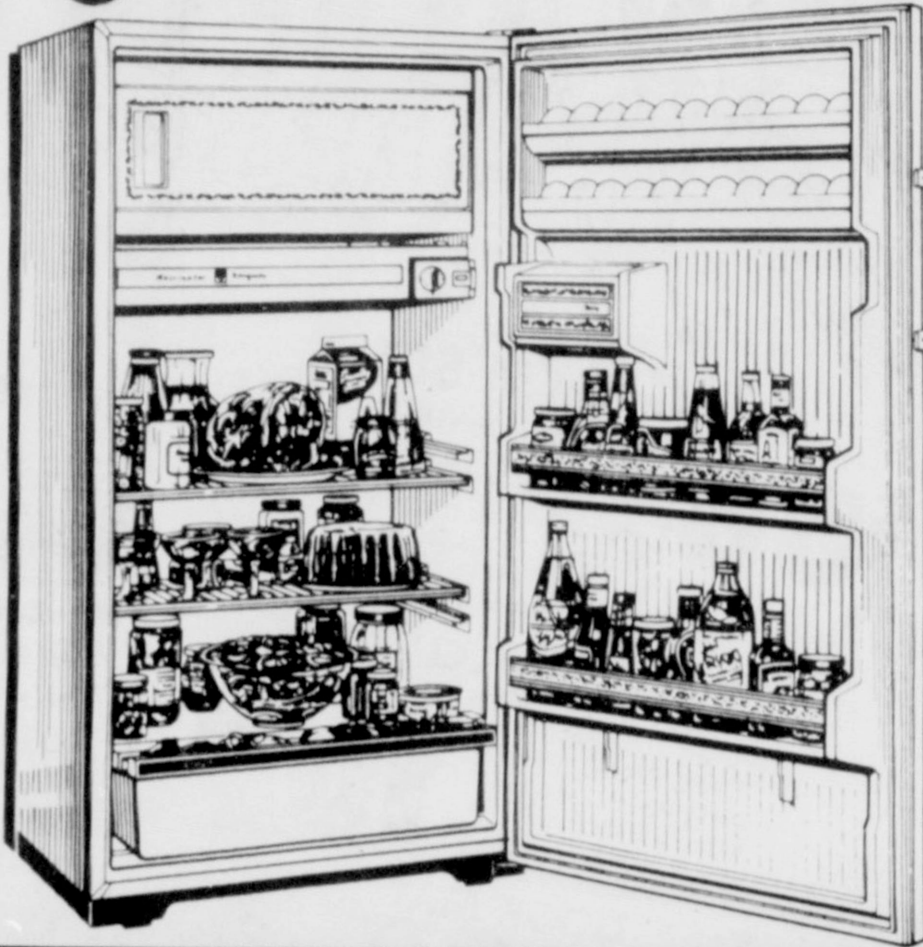

KELVINATOR craftsmanship at an easily affordable price! Efficient Trimwall construction with an adjustable temperature control to conserve electricity! Big 1.89 cubic foot freezer, spacious slide-out crisper, butter keeper and egg storage rack! Regularly \$299.97! 130-100

SAVE \$33.97 \$266

**WHITES EASY
CREDIT TERMS**

**FREE DELIVERY
WITHIN OUR
SERVICE AREA!**

KELVINATOR

NEW COMPACT DRYER

Fabric oriented time dial lets you choose automatic or timed drying! Features permanent press "cool down" and no-heat air fluff cycle. In white or harvest. 145-600, 602

\$187

NEW COMPACT WASHER

The famous Kelvinator Spacesaver uses 30% less water than conventional washers! Five water temperatures with automatic permanent press "cool down" to prevent wrinkles! In gleaming white or harvest gold! 145-500, 502

\$277



**14 Cu. Ft.
KELVINATOR
FREEZER**

\$277

Take advantage of frozen food sales & buy fresh produce in season! Top freezing coils give faster "cold recovery." 130-200

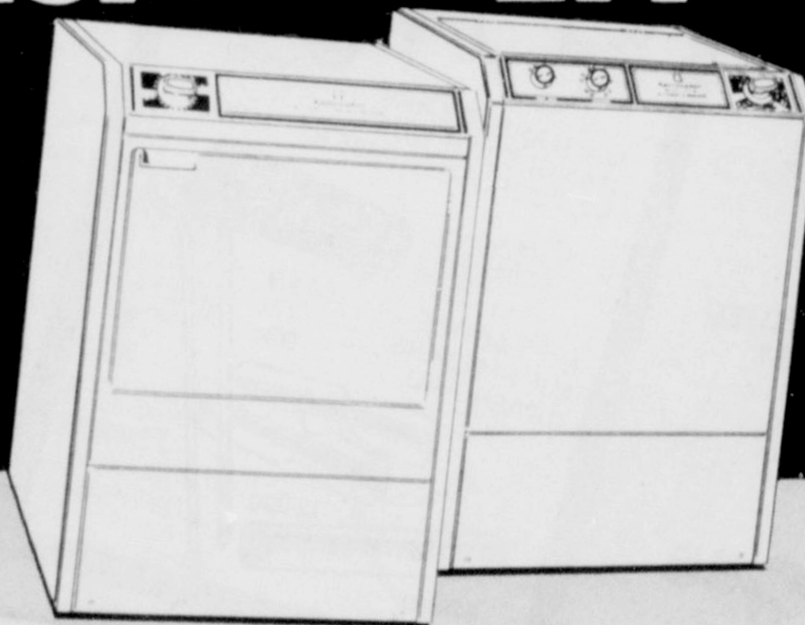

METAL SHELVING
5 sturdy, all steel shelves! 14-9008

12⁸⁸

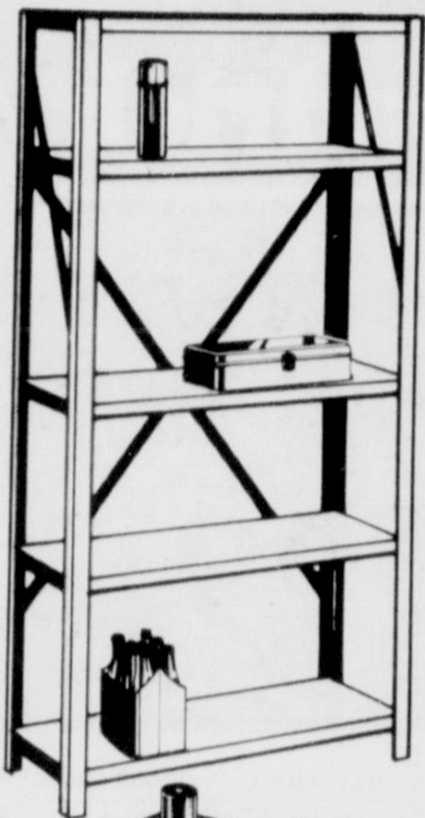

TRIPLE WRITTEN LIMITED WARRANTY

1. FREE LIMITED REPLACEMENT 18 Months on Magic 60.
2. TIME LIMITED WARRANTY All adjustments guaranteed on month's end, based on outright price before trade-in.
3. Warranty honored by ALL White Stores.

INTERIOR LATEX

Six fresh springtime colors to brighten your favorite rooms. . .and WHITES HAS IT! It's washable, colorfast, lead free, and dries in only 1/2 hour. Easily applies to any surface! Easy soap 'n water cleanup! 3-3000-2, 4, 8, 10

3⁹⁹
Gal.



EXTERIOR LATEX PAINT
WHITES HAS IT for the outside, too! Applies with brush, roller or spray & dries in minutes! It's washable & mildew resistant; in 4 colors. 3-3102-6

5⁹⁹
Gal.

Maintenance-Free BATTERY

And WHITES HAS batteries, too! Our finest is this great Magic 60. . .it'll give you years of dependable cold weather starts with plenty of reserve capacity! Never needs water. 152-400, 1, 2

38⁸⁸
Exch.

FREE INSTALLATION

HEADLAMPS

12 volt SAFE T BEAMS are original equipment replacement!

2-1167-69

1⁶⁶
Ea.



21. Pc. SOCKET SET

Choose metric or standard! 3/8" x 1/4" sockets. 22-851, 2



7⁹⁹

76 Pc. TOOL SET

WHITES HAS a treasure chest of most needed tools—sockets, wrenches, hex keys, hacksaw!

22-854

\$33

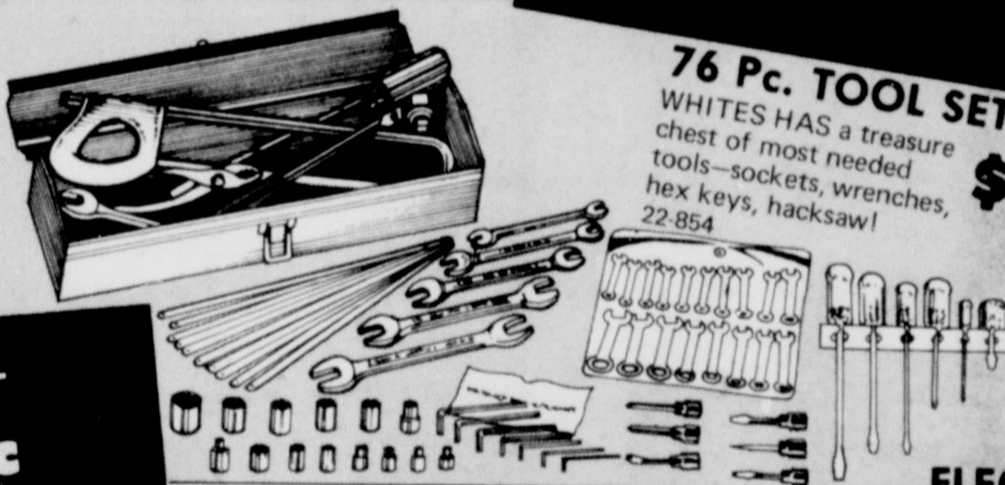

MOTOR OIL

Whites has Havoline oil at a bargain price!

48^c

OIL CHANGE KIT
11 qt. pan, filter wrench, tapper!

46-49

1⁹⁹



ELECTRONIC CRUISE CONTROL

SAVE GAS! Holds a constant speed—even up & down hills! Fits all 4-6-8 cylinder cars; no special tools needed. 35-2100

\$77



Want some straight facts about a great opportunity with WHITES? We can help YOU own your own thriving WHITES dealership! Call or visit the store that sent you this catalog for more details.

B.F. Goodrich

SILVERTOWN BELTED WHITEWALL TIRES

PRICED AS LOW AS... **4** TIRES FOR **\$99** * FOR A78-13 * Plus F.E. Tax

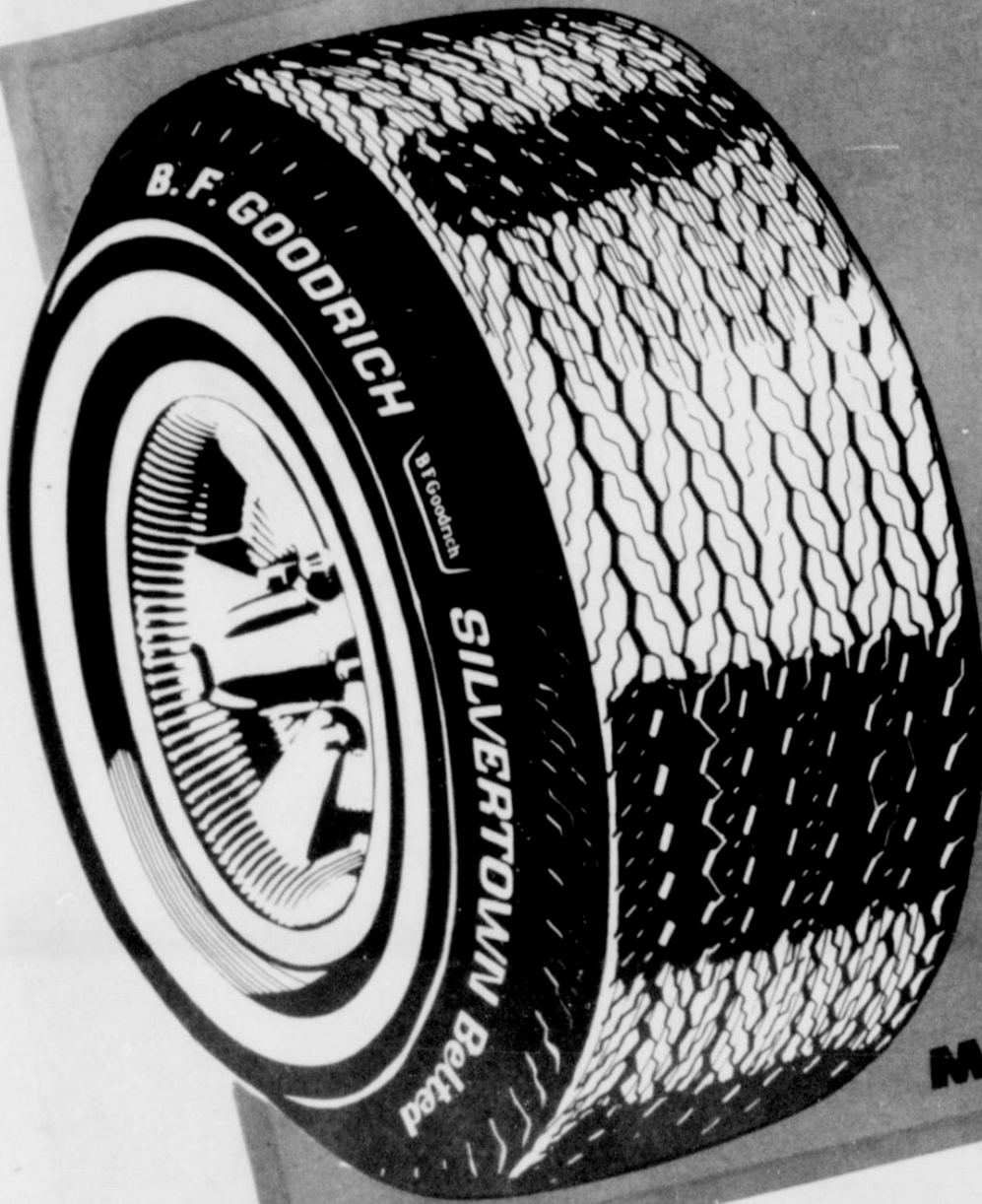

TIRE SIZE	F.E. TAX	REG. PRICE	SALE PRICE
A78-13	\$1.73	\$29.88	4 for \$ 99*
E78-14	\$2.26	\$36.88	4 for \$127*
F78-14	\$2.42	\$38.88	4 for \$135*
G78-14	\$2.58	\$39.88	4 for \$139*
H78-14	\$2.80	\$43.88	4 for \$155*
G78-15	\$2.65	\$41.88	4 for \$147*
H78-15	\$2.88	\$43.88	4 for \$155*
L78-15	\$3.12	\$46.88	4 for \$167*

*Plus F.E. Tax Per Tire

MOUNTED FREE

PAN & ROLLER SET

9" roller for faster, easier painting!
6-262 **99¢**

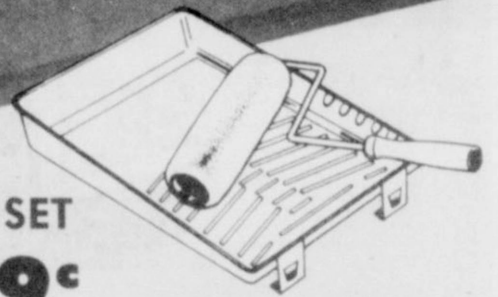

WHITES

AUTO WAX

Put a hard shell finish on your car! Fast, easy, lasts for months!

5.78
1.17
With Coupon



turtle wax

Expires 3-19-77

COUPONS

WHITES

SPARK PLUGS

67¢ With Coupon
Resistor plugs slightly higher!
30-300-31



Expires 3-19-77

COUPONS

WHITES

OIL FILTER

Clean oil means longer engine life!
44-808-43

1.97
With Coupon



Expires 3-19-77

COUPONS

WHITES

32 OZ. DRANO

Pulls the plug on stubborn clogs! 72-342

87¢
With Coupon



Expires 3-19-77

COUPONS

POYNORS' WHITES, INC. OF PORTALES
420 S. AVENUE C
PORTALES, NEW MEXICO

POYNOR'S WHITES, INC. OF MULESHOE
103 MAIN PHONE: 272-4552 or 272-4553
MULESHOE, TEXAS

SUPPLEMENT TO:
The Portales News Tribune
The Muleshoe Journal
The Friona Star

POYNORS' WHITES, INC. OF FRIONA
HIGHWAY 60, WEST PHONE 247-3270
FRIONA, TEXAS