

THE BORDEN STAR

VOLUME XXVIII

December 1, 1999

Serving the Counties of Borden, Dawson, Garza, Howard, Lynn & Scurry

Three Gail FFA members head to State

Three hundred high school FFA students from across West Texas gathered at Howard College for the Area II Leadership Contest on Saturday, November 20th, vying for the opportunity to advance to state competition. All of these teams placed either first or second in district to qualify them to compete in this area contest. Area II consists of 96 schools from El Paso to Sweetwater and Brownfield to Sonora.

Three members of the Gail FFA tasted sweet victory as they secured the first place bragging rights and a trip to state. Team members Hailey Adcock, Nick Flanigan and Joseph

Hardman competed against 7 other district winners to secure the first place Area crown in the Public Relations contest. Only the first-place teams at area qualify for the State FFA Leadership contest to be held December 4th at Sam Houston State University in Huntsville. Hailey, Nick and Joseph will travel to the contest and make their FFA presentation along with 9 other Area winning teams throughout the state. The contest is open to the public and everyone is invited to watch the students perform. Congratulations to the Gail FFA Public Relations Team. Take State!

Cont. to pg. 4

Double Victory Elementary/Jr. High U.I.L. Academic Teams Prevail

The Borden County School continued to prove itself in competition this past week as both the Elementary and Junior High U.I.L. Academic Teams brought home top honors in the District 9-A, East Zone competition.

Overall, Borden County elementary students amassed 802 points. The other competing schools'

scores were: Sands, 488.66; Ira, 321; Hermleigh, 258; and Westbrook, 242.33.

On the Junior High level, Borden County topped the scores with a total of 677.33. Sands placed second with 293 points and was followed by Westbrook, 290; Ira, 224; and Hermleigh, 119.66.

Individual results and

Cont. to pg. 4

Quarterfinal Loss to Groom ends Coyote Football Season

Seniors finish High School Careers with 38-5 varsity record over past three seasons

Defensive battles in six-man football are rare, especially on both sides of the ball. But, it was just that type of game Saturday in Floydada as the Borden Coyotes and Groom Tigers battled it out. When the smoke cleared, Groom advanced to the State Semi-Final Game thanks to a stingy defense that held the Coyotes to only 222 total yards offense.

The final score, 20-12, was indicative—this

contest was hard fought from the start; the Coyotes first drive stalled with negative yardage and that was to foreshadow things to come for the remainder of the first half.

Groom did score first, on a 46-yard touchdown run from scrimmage. The PAT was good as the Tigers took the early advantage, 8-0 in the first quarter.

Still, the Coyote defense showed that they

too had come to play ball as BHS held Groom scoreless the remainder of the half. Other than the 46-yard score, the Tigers would only gain 63 more yards of offense in the first half on the ground.

It took a fumble recovery by Ed Rodriguez with 7:56 to go in the 2nd quarter to spark the Coyote offense. Rodriguez recovered the ball on the

Cont. to pg. 3

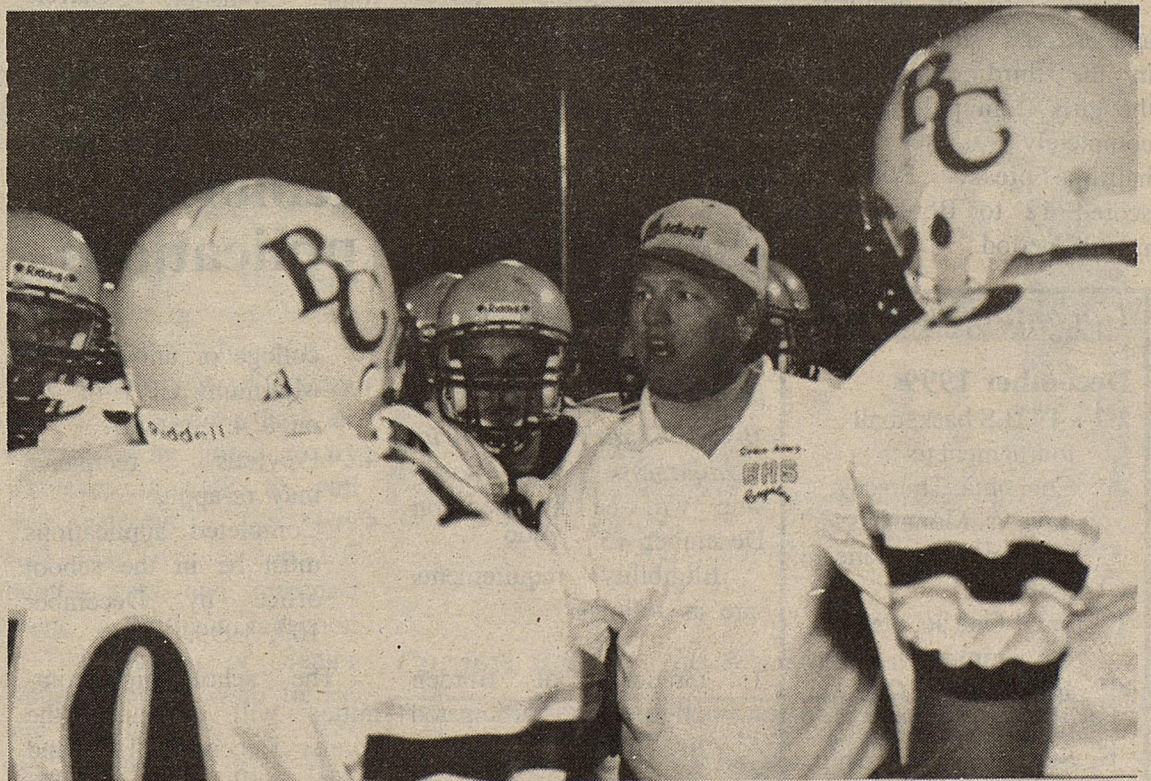

Cont. to pg. 4 *Coach Avery and his Fighting Coyotes!*

Basektball Results

Rebounding, Defense Lead Lady Coyotes to win over Roosevelt

BHS Prepares For Tournament Action This Week in Coahoma

In what is becoming a trademark statistic, the Lady Coyotes are winning the battle of the boards. And, in so doing, are finding themselves at 4-0 going into a busy weekend of tournament action.

Against Roosevelt before the holiday break on Tuesday, the Lady Coyotes jumped out to a 15-8 first quarter lead, highlighted by five steals to go with seven rebounds. Offensively, the girls took care of business as well as they were 50% from the field and four of six from the free throw line.

In second quarter action, BHS went on a 14-0 run that gave them the definite momentum going into halftime with a 40-18 cushion. Lindsey Smith found the three-point range twice in this quarter which padded the lead.

A rash of turnovers and a cold shooting spell in the third quarter kept the girls from pulling away completely after the halftime break. Roosevelt scored 12 to Borden's 13 in this period.

Rebounding in the final period, nine total boards, along with nine steals, put the Lady Coyotes in command as they closed out the game with a 69-42 win.

Coach Gailan Winegarner's Lady Coyotes prepare now to defend their Coahoma Tournament title won in 1998. They will face Crane in first round action Thursday at 3:30 in the high school gymnasium. See the complete bracket for boys and girls in another section of *The Borden Star*.

Game Stats 11-23-99 vs Roosevelt

Baeza.....6 pts., 6 boards
Watts.....5 pts., 3 steals
Dye.....1 board, 1 assist
Adcock....2/2 free throws
Mayes.....24 pts., 3 assists
Poole.....1 board, 1 steal
Smith.....8 pts. (two 3's)
Isaacs.....4 pts., 3 steals
Hensley....5 steals, 2 assts.
Thomas....2 rebounds
Wootan....20 pts., 8 boards

Bert Dennis Memorial Scholarship Applications

Applications are now available in the School office to apply for the **Bert Dennis Memorial Scholarship**. The scholarship will be awarded on December 15th, 1999.

Eligibility requirements are as follows:

1. Graduate of Borden High who participated in school athletics.
2. Completion of 30 hours at an accredited

Dawson Dragons Outlast Coyote Pups and Missy Coyotes

Monday night junior high basketball action found the Coyote teams on the short end of both games. The boys lost to Dawson, 36-20, while the girls' team fell 32-29.

In the second game of the season and their first in two weeks, the Coyote Pups started off slowly. The Dragons outscored the boys 16-4 in the first quarter and never relinquished this lead.

Dan Griffin scored the Pups first points and finished the evening high point with 12. In the second quarter he netted three more and John Stamper hit one free throw, but the Pups continued to trail at half by the score of 26-8.

The third quarter saw a run by BJHS as several Coyote players saw action and played the floor well. Evan Winegarner and Tyler Wallace hit a bucket each while defensively the Pups held Dawson to just four points in this quarter.

Seeing action during this period were also Charles Grant, Clay John Anderson, Andy Lozano, John Wilson, Garrett Chapman, Adam Carter, Derek Rodriguez, Dusty Gwinn, and Billy Roper.

Coach Trey Richey's Pups outscored the Dragons in the final period, holding Dawson to just six points. For BJHS, Lozano nailed a three-pointer while Griffin added three more points to this total.

The girls were plagued by the two-week layoff as well, going scoreless in the first quarter and trailing Dawson 10-0 at the end of one.

Coach Allan Wootan's 6th, 7th, and 8th graders stormed back in the second to make a ballgame of it, scoring eight points to Dawson's four.

Cassidy Rinehart, Shayla Gass, and Emily Mayes all had a goal while LaShae Johnson added a free throw to make the score 13-8 at the half. Thelma Balaque, Shiloh Pool, Cassidy Ogden, Ashley Ellison, Mandy Vasquez, Megan Brooks, and Kisha Clement all saw some action in the second quarter to help get the girls back into the game.

Halftime sometimes does wonders, and in the girls' case, Coach Wootan must have given one of his

best speeches. In the third quarter the Missy Coyotes played ball, creating turnovers and scoring on steals to the tune of 14 points, including a 10-0 run in this quarter. Shayla and Emily led the way with four points and six points while LaShae and Ashley scored two points each. LaShae also pulled down key rebounds in this period to help the cause.

Leading at the end of the third period, 22-20, the Missy Coyotes seemed ready to take control. But Dawson wasn't through yet and finished strong in the final quarter by outscoring BJHS 12-7 to finish ahead 32-29. Shayla and Emily closed the gap with scoring in this period, but it wasn't enough as the girls fall to 0-2 on the year.

Next action for the young Coyotes will be Monday, December 6, in Ira. This will be a district contest and on the road—the junior teams will not see the homecourt until after the Christmas holidays.

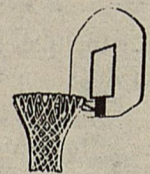

Tis the season . . .

The kindergarten and first grade classes want to do a project that will help them get into the "real spirit" of Christmas. We would like to give the gift of Christmas to someone else. We are looking for grandparents and senior friends who might be able to come to the school and celebrate Christmas with us. If you would like to take part in this program, please call Deidre Smith @806/439-6379 or Paula Miller @ 915/573-6004.

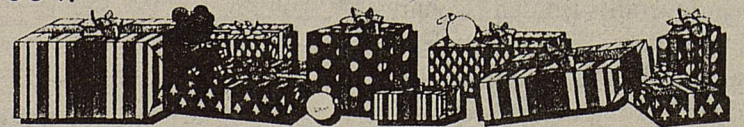

Upcoming Events:

December 1999

2nd - 4th H S basketball tournament @ Coahoma, Thursday: boys vs. Monahans @ 2:00; girls vs. Crane @ 3:30 p.m.

2nd Jr. H One act play for community, 7: p.m.

4th Jr. H. District One Act play @ Dawson State FFA Leadership Contest @ Huntsville

COYOTE FOOTBALL '99

Quarterfinal Loss to Groom

Cont. from pg. 1

Coyotes 37-yard line and from there a drive ensued that finished with Kevin Pinkerton's one-yard scoring strike to Rodriguez to finally get the Coyotes on the board.

The extra point conversion failed and the score was to stay at 8-6 going in to the half.

Before the half ended, however, BHS's defense stopped Groom deep in Coyote territory, preventing what could have been a big momentum boost going in to the locker room. Pinkerton's defense in the secondary enabled the Coyotes to end the half on a deflected pass play in the end zone.

Statistics at half time indicated the struggle that the offense was having on the evening. For the first time all year, the normally potent group was held to only 25 yards on the ground. Things would soon change, and it looked like for the better as the second half got underway.

A running game developed after the Coyotes held Groom on 4th down to start the 3rd quarter. With the ball, BHS went to the trusty sweep play and called Senior Joseph Hardman's number, who promptly answered with a 61-yard touchdown run; however, several other things emerged in the 3rd quarter—holding calls. And just like last week against Sanderson, Hardman's run was nullified by the ten-yard penalty.

No problem. Rodriguez decided he could do the sweep right thing and on 3rd down scampered 63 yards for a score to put

the Coyotes in the lead. The PAT failed, but finally BHS could see some offense get them back into the game, taking a 12-8 lead.

Groom was forced to punt on its next possession as well, and it seemed that Coyote playoff experience was going to make the difference again. With 2:08 remaining in the 3rd quarter, on a Coyote drive which seemed destined for the end zone, Groom's defense did their thing and picked off the first of two crucial interceptions. Less than a minute later, the Tigers scored on a 1-yard run which had been preceded by a 56-yard run to take the score to 14-12 at the end of the 3rd quarter.

What happened next will be a fourth quarter that Coyote and Tiger fans will remember for a long time...one of those 10-minute quarters when people stood and held their breath and cheered and agonized and watched as both their teams proved why they had advanced to this stage of the playoffs. And here, is where the story really begins.

Almost immediately, the Coyotes found themselves back up against a wall. Thirty seconds in to the final period, Groom returned an interception for 50 yards and a score. And as if that weren't deflating enough, the Coyotes had a penalty on the failed kick, which gave Groom another chance at the conversion. This time they decided to just run the ball and get the valued one-point which would have made it a nine-point

game and forced the Coyotes to score twice to win. But, the defense held, and the score was 20-12.

Holding penalties and another fumble prevented the Coyotes from scoring again, but still BHS would not buckle. Perhaps the most crucial play of the game and one that provided, in retrospect, much to talk about, was a 56-yard run by Groom. The important thing to note was that Pinkerton came from across the field as

Coyote defenders around him had been knocked to the ground and chased the Tiger runner down at the one-yard line.

With less than three minutes to play, Groom was sitting pretty...first and goal on the one, leading 20-12. Many Coyote fans had given up, but that is why they were in the stands. The Coyote players and coaches pulled off the impossible—a goal-line stand that even saw Groom pushed back three yards. This series of downs was a Coyote highlight according to Assistant Coach Trey Richey.

"Kevin gutted it out. That was a touchdown-saving tackle. The guys just stepped up and showed their character," he said.

There was still time, and it appeared that the Coyotes were going to try whatever it took to pull this one out. The very first play was sweep left bootleg pass, and Pinkerton found a brilliant reception in the hands of Senior Robert Stamper who turned and caught this one over his shoulder for a 31-yard gain.

Running plays and a screen play took the Coyotes into Groom territory with under two minutes to play, but on fourth down, the Tigers stopped Rodriguez and simply had to ride out the clock to claim the quarterfinal victory and earn a berth in this week's semi-final against Rule.

Final statistics show that the Coyotes made the halftime adjustments as Rodriguez rushed for 118 second-half yards, Hardman finished with 30 while Coyote passers completed 7 of 14 for 60 yards. Groom's offense was held in check, other than the two long runs, as their total offense covered 280 yards, only 44 of that in the air.

Pinkerton punted three times for an average of 44 yards per kick, but the Coyotes suffered penalties and turnovers which proved to be the turning point in this game.

Defensively, the

Coyotes were lead by Hardman, Pinkerton, Grant and Ramon Griffin who all made several solo tackles, including some on key 4th down possessions by Groom. It was Grant's sack of the Tiger running back on the goal-line stand late in the game that gave BHS one final shot at victory.

The season ends with a 10-3 record. As pointed out in the headline, this year's seniors finish with varsity career records of 38-5, having been sophomores on the State Championship team of 1997 and juniors on the State Runner-up team of 1998. And with the end of the seniors' careers, coaches took note.

"I can't say enough about these guys...they instilled heart and character...this will contribute to success down the road," said Coach Richey.

And down the road isn't that far away.

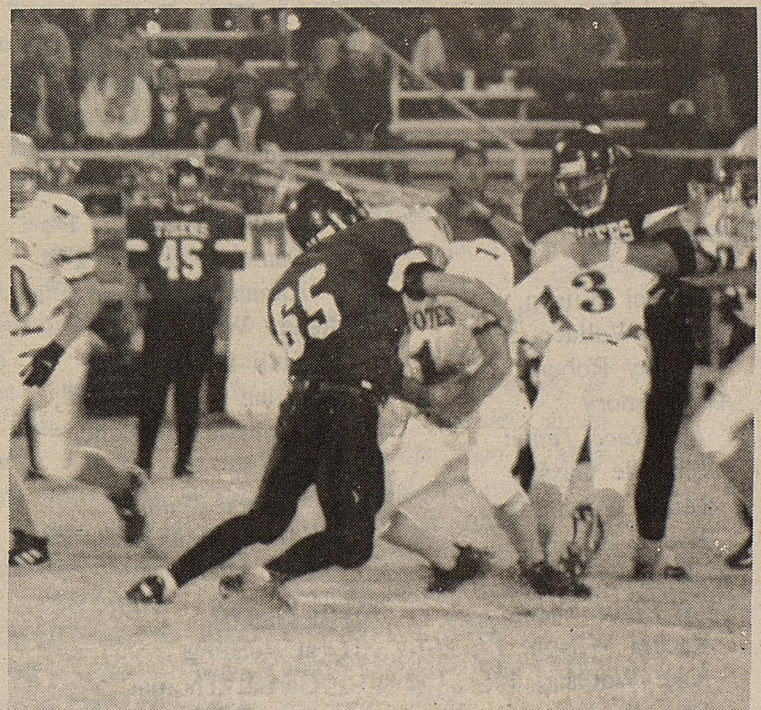

Coyotes fight to the finish, never giving up!

The Borden Star (USPS or PUBLICATION NO. 895-520) is published weekly except Christmas and New Year's week for \$12.00 per year by the Borden Star, P.O. Box 137, Gail, Texas 79738. Second-class Postage paid at Gail, Texas. POSTMASTER: Send Change of Address to the Borden Star, P.O. Box 137, Gail, Texas 79738.

Double Victory

Cont. from pg. 1

competitors from Borden County are as follows:

Kindergarten:

Oral Reading -
Katie Pelham, 1st;
Bethany Stamper, 2nd;
Chance Taylor, 5th.

First Grade:

Oral Reading -
Taylor Richey, 2nd;
Ethan Winegarner, 6th.

Second Grade:

Oral Reading
Chelsea Stephens, 2nd;
Rachael Payne, 3rd;
Lacey Roberts, 5th.
Storytelling
Rachael Payne, 2nd;
Karl Lamming, 6th;
Lacey Roberts
Creative Writing
Rachael Payne, 1st;
Lacey Roberts, 2nd;
Chelsea Stephens, 3rd.

Third Grade:

Oral Reading
Carlos Hernandez, 4th;
Jake Cooley;
Jessica Pelham.
Storytelling
Carlos Hernandez, 1st;
Chance Pool, 3rd;
Jessica Pelham, 5th.
Spelling
2nd Place Team:
Baylee Benavidez, 4th;
Jessica Pelham, 5th;
Carlos Hernandez.
Ready Writing
Carlos Hernandez;
Jessica Pelham;
Chance Pool.

Fourth Grade:

Oral Reading
Rachel Wilson, 4th;
Kate Wallace, 5th;
Shelby Roberts, 6th.
Art Memory
1st Place Team:
Sharelle Gass,
Miller Valentine,
Rachel Wilson.
Spelling
1st Place Team:
Rachel Wilson, 1st;
Kate Wallace, 4th;
Sharelle Gass.
Number Sense
1st Place Team:
Rachel Wilson, 1st;
Kate Wallace, 2nd;
Sharelle Gass, 4th.

Ready Writing
Rachel Wilson, 3rd;
Sharelle Gass;
Shelby Roberts.

Fifth Grade:

Oral Reading
Lindsey Stamper, 1st;
Kalli Poole, 3rd;
Symeron Rinehart, 5th.
Art Memory
1st Place Team:
Kylan Reynolds
(Perfect Score),
Rowdy Cleary,
Kalli Poole.
Listening Skills
1st Place Team:
Clint Chapman, 1st;
Rowdy Cleary, 2nd;
Kylan Reynolds, 2nd.
Music Memory
1st Place Team:
Sarah Harding,
Alejandra Mujica,
Jake Payne,
Kalli Poole,
Lindsey Stamper.

Number Sense
1st Place Team:
Rowdy Cleary, 1st;
Ana Arellanos, 3rd;
Daniel Williams, 4th.

Spelling
1st Place Team
Kylan Reynolds, 2nd;
Rowdy Cleary, 3rd;
Alejandra Mujica, 5th.

Maps, Graphs, & Charts
1st Place Team:
Daniel Williams, 1st;
Rowdy Cleary, 6th;
John Cowart.

Dictionary Skills
1st Place Team:
Lindsey Stamper, 1st;
Daniel Williams, 2nd;
Alejandra Mujica, 4th.

Ready Writing
Kalli Poole, 1st;
Kylan Reynolds, 5th;
Dannelle Copeland.
Spelling
1st Place Team:
Whitney Anderson, 2nd;

Sixth Grade:

Oral Reading
Garrett Thomas, 1st;
Cassidy Ogden;
Shiloh Pool.
Maps, Graphs, & Charts
1st Place Team:
Whitney Anderson, 2nd;
Seth Williamson, 5th;

J. Ryan Gicklhorn.
Dictionary Skills
Whitney Anderson, 3rd;
Megan Brooks;
Seth Williamson.

Music Memory
2nd Place Team:
J. Ryan Gicklhorn,
Caden Nowlain,
Aaron Pigford,
Garrett Thomas.

Mathematics
1st Place Team:
Whitney Anderson, 2nd;
J. Ryan Gicklhorn, 4th;
Garrett Thomas.

Number Sense
1st Place Team:
Whitney Anderson, 1st;
J. Ryan Gicklhorn, 2nd;
Shiloh Pool.

Calculator
1st Place Team:
Cassidy Ogden, 1st;
J. Ryan Gicklhorn, 5th;
Caden Nowlain.
Cassidy Ogden, 4th;
Megan Brooks.

Ready Writing
Cassidy Ogden, 3rd;
Shiloh Pool, 4th;
Garrett Thomas.
Listening Skills
Andrew Lamming;
Aaron Pigford;
Shiloh Pool.

Seventh Grade:

Oral Reading
Tyler Wallace, 1st;
Cassidy Rinehart, 2nd;
Ashley Ellison, 3rd.

Modern Oratory
John Wilson, 1st;
Garrett Chapman, 2nd;
Ashley Ellison, 3rd.

Impromptu Speaking
Adam Carter, 2nd;
Cassidy Rinehart, 3rd;
Tyler Wallace, 4th.

Mathematics
1st Place Team:
John Wilson, 1st;
Garrett Chapman, 4th;
Adam Carter, 5th.

Number Sense
1st Place Team
John Wilson, 1st;
Billy Roper, 2nd;
Garrett Chapman, 3rd.

Calculator
1st Place Team:
John Wilson, 1st;
Garrett Chapman, 3rd;
Billy Roper, 4th.

Dictionary Skills
1st Place Team:
John Wilson, 1st;

Gail FFA members

Cont. from pg. 1

Other Gail FFA leadership teams competing at the Area contest in Big Spring were: Radio Team, consisting of Kaci Poole, Ramon Griffin and Payton Brown, placed 1st in District and 4th in Area. Ag Issues team, consisting of Robert Stamper, Kandace Kimmel, T.C. Stipe, and Jacob Zant placed 2nd District and 4th in Area. Senior Skills team members consisting of Shawna Kempf, James Bond and Cody Nowlain placed 1st in District and 3rd in Area.

In the District Contest, which was held in Gail on November 15th other Gail FFA leadership teams also showed their true colors as they placed as follows: Junior Chapter Conducting team, Brionne Jackson, Tanner Poole, Kyla Culp, Kevin Ellison, Bobbie Kempf, Raul Rodriquez and Dalene Kempf placed 5th in District. Junior Creed members, were: Bobbie and Dalene Kempf and Senior Creed member, Jessica Ellison.

All together, twenty members of the Gail FFA

Emily Mayes, 2nd;
Garrett Chapman, 4th.

Listening Skills
1st Place Team:
John Wilson, 1st;
Garrett Chapman, 2nd;
Ashley Ellison.

Maps, Graphs, & Charts
2nd Place Team:
John Wilson, 1st;
Garrett Chapman;
Derek Rodriguez.

Science
1st Place Team:
John Wilson, 1st;
Billy Roper, 2nd;
Ashley Ellison.

Ready Writing
Garrett Chapman, 1st;
John Wilson, 5th;
Ashley Ellison.

Spelling
1st Place Team:
John Wilson, 1st;
Emily Mayes, 2nd;

Chapter culminated hours of hard work the past two months in preparation for these contests. Congratulations to all of these members. You did a great job.

Billy Roper, 3rd.

Eighth Grade:

Oral Reading
John Stamper, 3rd;
Shayla Gass, 4th;
Evan Winegarner, 6th.
Modern Oratory
Alexis Brooks, 5th.
Impromptu Speaking
Shayla Gass, 4th;
John Stamper, 6th;
Evan Winegarner.

Mathematics
1st Place Team:
Kyle Pinkerton, 1st;
John Stamper, 2nd;
Evan Winegarner.

Number Sense
1st Place Team:
John Stamper, 1st;
Kyle Pinkerton, 2nd;
Evan Winegarner, 3rd.

Calculator
1st Place Team:
John Stamper, 1st;
Kyle Pinkerton, 2nd;
Evan Winegarner.

Dictionary Skills
2nd Place Team:
Dusty Gwinn, 3rd;
John Stamper, 5th;
Kyle Pinkerton, 6th.

Listening Skills
Dan Griffin, 5th;
Andy Lozano;
Kyle Pinkerton

Maps, Graphs, & Charts
2nd Place Team:
John Stamper, 2nd;
Kyle Pinkerton, 3rd;
Andy Lozano.

Science
Dan Griffin;
Kyle Pinkerton;
Evan Winegarner.

Ready Writing
Kyle Pinkerton, 3rd;
Dan Griffin;
John Stamper.

Spelling
1st Place Team:
Kyle Pinkerton, 2nd;
John Stamper, 4th;
Andy Lozano.

Congratulations to all! We are proud of you!

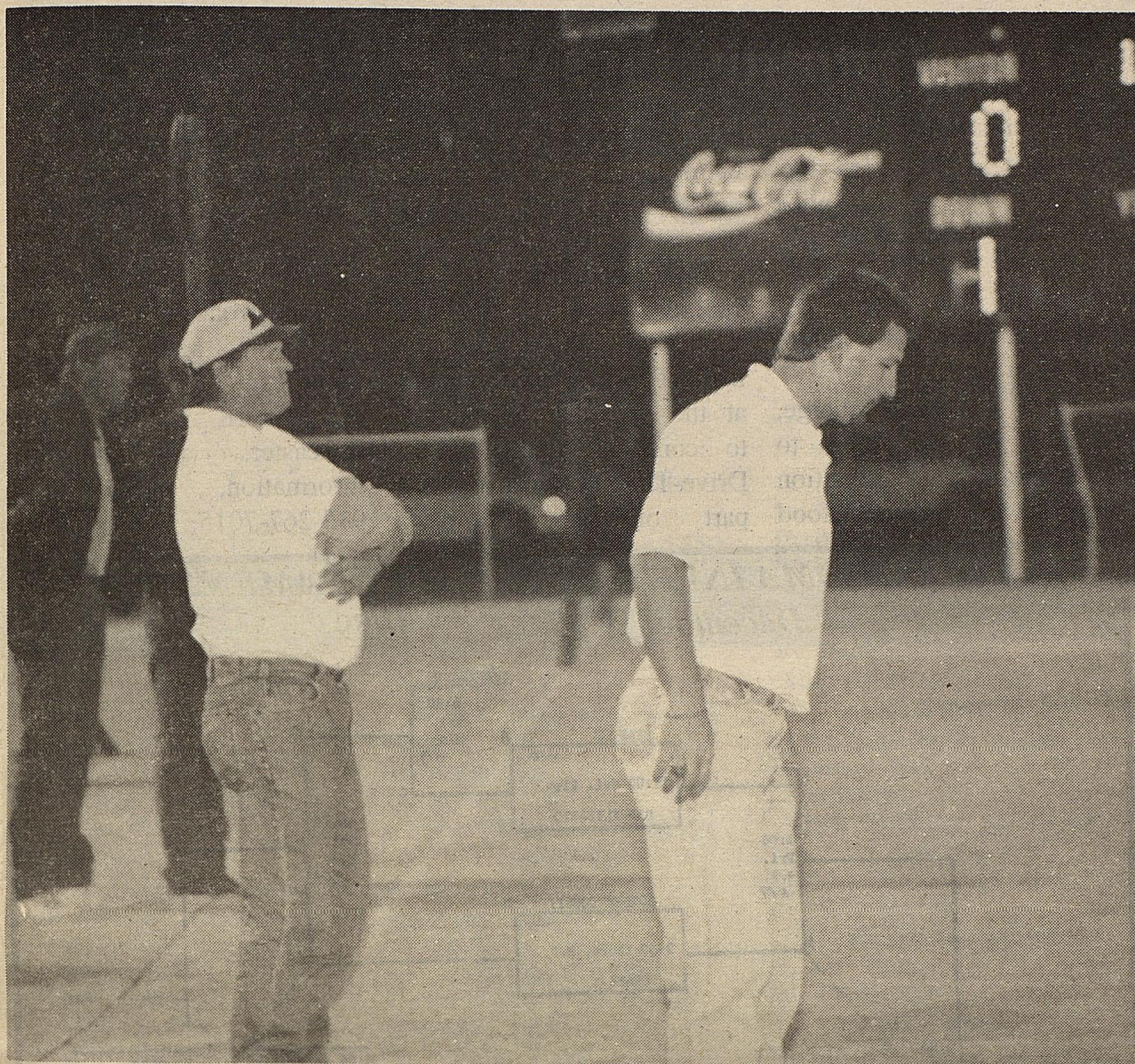

For the Love of the Game

A feature editorial

By Sue Jane Mayes

One grew up on a dusty panhandle cotton field; the other was a "city" boy, if you can call Jayton a city.

They are a decade apart in age and as different as the lives they lead.

One has been married ten years, has traveled to his heart's content with his wife, gone to movies, slept late and raised two dogs. That will soon change when he becomes a dad for the first time in May at the age of 40.

His partner, the young one, has seen the world, too, with his wife—the world of diapers and toys and sleepless nights because of their four children, all coming before his 30th birthday.

So what has brought them together, these two men, who seem and actually are very different. Have opposites attracted as they so often do, or have we just been lucky?

They have stayed in Borden County now, a combined total of 19 years. Coaches don't do that—they are supposed to "move up" especially when they have that State Championship under their belt and even a Runner-up medal to follow.

They have remained. They are loyal. They love this game. Because this game, you see, is played year after year by kids. Not by adults or parents or those of us who may think we know more.

This game, any game, is played by our sons and daughters, and coaches who have the love of the game know that. That want them to love it as they have, and obviously these two guys have done a good job.

When asked what they would miss the most, the senior players unanimously agreed that it was the "camraderie, the fun, the feeling that we

had contributed."

Notice what is missing in that quote: not a mention of a state medal or a particular win or loss. It reflects a love of the game.

Whatever you may feel about coaches and the decisions they make in a game, think again about what they have really accomplished in the big picture.

Your sons have been blessed to have been taught by men who are good men, who want their players to enjoy this pastime.

Bobby Avery and Trey Richey coach for all the right reasons and it is reflected in their players' behavior, in victory or defeat.

They coach for the love of the game.

Acting Up?

Jr. High Thespians Take the Stage



Thursday night at 7:00 p.m. marks the theatrical debut of several Borden County Junior High School students as they present a community performance of their district One-Act Play entry, Breaking Up Is Hard To Do, by Dennis Snee. The production is a dress rehearsal in preparation for the district contest that will be held at Dawson High School in Welch this Saturday.

The comedy takes a light-hearted look at the different situations in which "breaking up" is a possibility. Eighth grader Dan Griffin narrates the play through three couples, each of whom are considering parting ways with one other.

Seventh graders Ashley Ellison and John Wilson portray an elderly couple who is questioning the reality of their 50 years together.

Following this couple are two middle-aged adults who are contemplating marriage. When a job change forces one of them to move, the final result is questionable. Shayla Gass and Kyle Pinkerton, both eighth graders, bring this couple to life.

To close the play, seventh grader Cassidy Rinehart and eighth grader John Stamper relate how breaking up as a teenager can be an extremely difficult time in one's life, particularly when one of his or her egos gets in the way. Evan Winegarner, eighth grader, causes the eventual resolution and brings the play to its close.

Serving as crew members for the production

are Clay John Anderson — lights, Billy Roper — sound, Emily Mayes — stage manager, and Derek Rodriguez — curtain. Understudies include Adam Carter and LaShae Johnson.

Come support the students and fine arts programs in Borden County. If you are interested in attending the competition on Saturday, the four competing plays begin promptly at 1:30 p.m. with Loop and Wellman-Union preceding Borden County. Estimated performance time for Borden County is 3:00 p.m. Dawson completes the competition. Results and critiques follow soon thereafter.

Menu

Lunch: \$1.00 K-5th
\$1.25 7th-12th
Breakfast: 50c

December 6th - 10th

MONDAY: Pizza, Corn, Okra, Fruit & Milk
Breakfast: Pancake Pups, Fruit, Juice & Milk
TUESDAY: Chicken Fried Steak, Potatoes, Green Beans, Hot Rolls, Ice Cream, & Milk
Breakfast: Cereal, Toast, Juice & Milk
WEDNESDAY: Spaghetti, Carrots, Salad, Garlic Toast, Pudding & Milk
Breakfast: Pancakes, Ham, Juice & Milk
THURSDAY: Turkey & Dressing, Potatoes, green Peas, Rolls, Pie, & Milk
Breakfast: Cinnamon Toast, Fruit, Juice & Milk
FRIDAY: Cheeseburger, French Fries, Salad, Cup, Cookies & Milk
Breakfast: Donuts, Fruit, Juice & Milk

Branon Funeral Home

Serving in this area since 1922

806/872-8335

Lamesa, Texas

13th Annual Texas' Largest "Live" Drive Through

Nativity December 9-12, 6:30 - 9:30 p.m.

See one of the most beautiful and meaningful Christmas presentations in Texas this season at First Church of the Nazarene, 1400 Lancaster, Big Spring, Texas, December 9-12, 6:30-9:30 p.m. each evening. This is one of the most unique and captivating presentations of the Christmas story anywhere. This wonderful presentation began in 1986, when Pastor Gary Smith encouraged the members of the Big Spring First Church of the Nazarene to do something very different for the community in presenting the story of Christmas. It began with only seven scenes and has grown over the years to include seventeen scenes, live animals and a cast of over 130 people. Every scene is beautifully painted and decorated to authentically represent the ancient buildings and places of years gone by. A beautiful trail of luminary leads you through this wonderful presentation of Christmas. A professionally produced cassette tape or compact

*I don't have a lot of riches; sometimes the going is ruff.
My family and friends love me, that makes me rich enough.
I just thank God for His blessings and the mercy He has bestowed.
I'm drinking from my saucer for my cup is over flowed.*

*Thanking all of my Borden County friends
for the flowers, cards, food and prayers.*

*God Bless Each of You,
Jeanette*

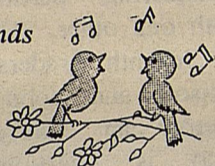

Sheriff's Notice of Sale

THE STATE OF TEXAS
COUNTY OF BORDEN

Whereas by virtue of the Writ of Execution issued out of the District Court of Scurry County, Texas, on the 6th day of October, 1999, in Cause No. 15010, where Wacey Enoch Lee Parks, Caleb Tye Parks, and Calley Jo Parks, Minor Children, were Plaintiffs, and Gary Don Parks was Defendant, on a judgement rendered in said Court against Defendant, and in favor of said plaintiffs for the sum of Twenty-one thousand six hundred fifty-two and eighty-one/100 DOLLARS, with interest thereon from the 8th day of October, 1993, at the rate of ten percent per annum, together with all costs of suit; I did on the 27th day of October, 1999, at 2:20 PM, levy upon the following described mineral interest situated in Borden County Texas, as the property of Gary Don Parks to wit:

WRIT OF EXECUTION
WACEY ENOCH LEE PARKS, CALEB TYE PARKS,
AND CALLEY JO PARKS, MINOR CHILDREN
VS
GARY DON PARKS

EXHIBIT "A"

1. The East 450 acres of Section 3, Block 2 T&NO Ry. Co.: Borden County
2. All of Section 677, Block 97 H&TC Ry. Co.: Borden County

On the 7th day of December, 1999, being the first Tuesday of said month, at 10:00 AM on said day, at the courthouse door north entrance of Borden County in Gail, Texas, I will offer for sale and sell at public auction for cash to the highest bidder, all rights, title, and mineral interest of Gary Don Parks in and to said above described property.

Witness my hand this 27th day of October, 1999.
Royale D. Lewis, Sheriff, Borden County, Texas
By Billy J. Gannaway, Deputy

disk, played in your car stereo, tells the story of each scene that takes you back over 2,000 years ago. Children and adults alike will thrill to the sights and sounds of this incredible event as the story of Christmas unfolds before your very eyes.

There is no charge, however in an effort to help the local Salvation Army in their canned food

drive this year, we are asking people to consider bringing canned food with them as they come to the presentation. Each year this wonderful event is brought to the community free of charge. And as always, there is opportunity to make financial contributions at the exit that enables us to continue to make the Drive-Through Nativity a part of your family's

Christmas tradition. We are sure it will warm your heart and bring you back to the reality of the true meaning of Christmas.

The entrance to the Nativity Drive-Through is best approached from the west on Martin Luther King Jr. Boulevard and then turn south onto Lancaster. For further information, please call 915-267-7015.

COAHOMA INVITATIONAL TOURNAMENT December 2nd, 3rd & 4th, 1999

GIRLS

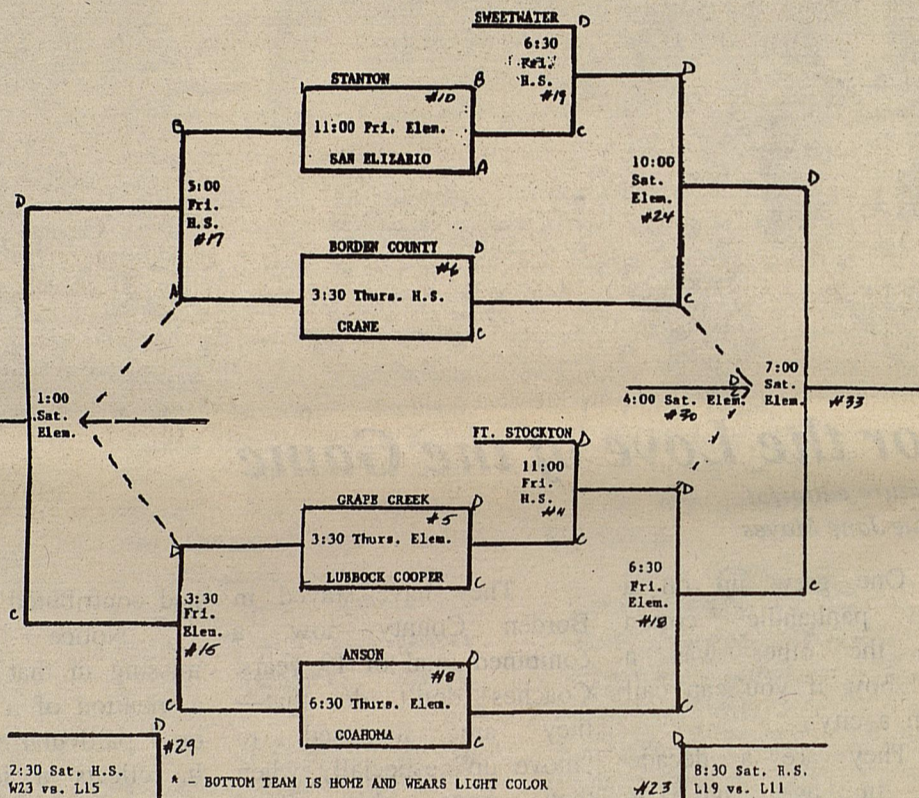

BOYS

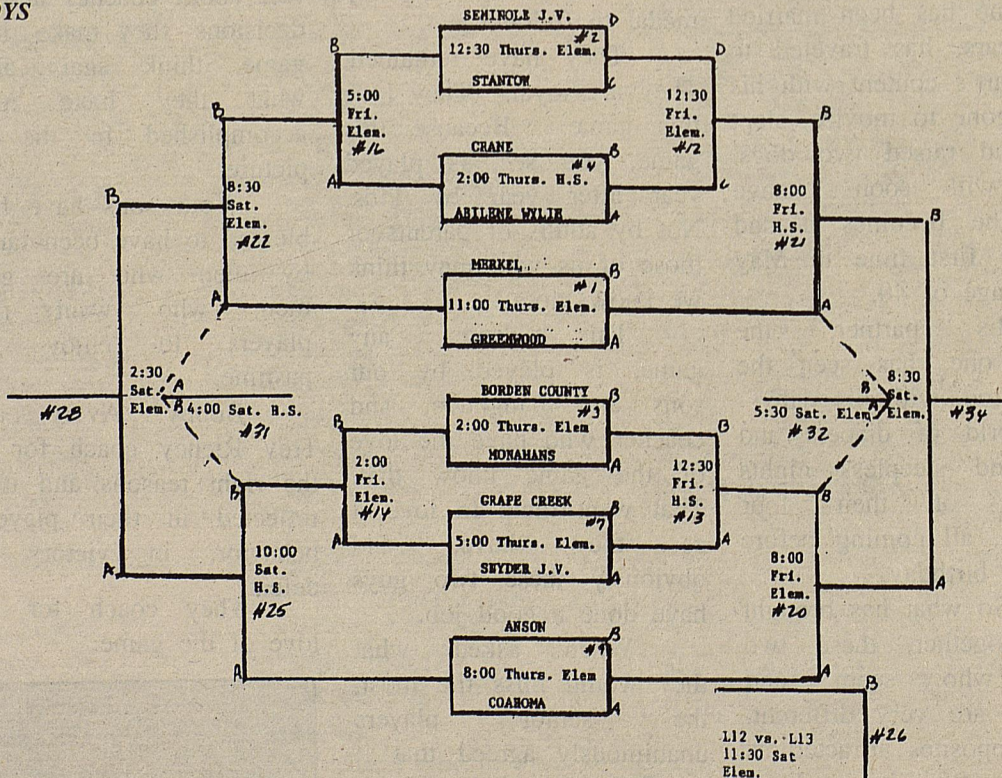

Sixth Annual Lighting of the "Star" on Gail Mountain



The "Star" on Gail Mountain will be sponsored on the following nights **In Memory Of** and **In Honor Of** the following:

November 26th
IN HONOR OF:
DELMO & MARTHA PEARCE
by the Citizens of Borden Co.

November 27th
IN MEMORY OF:
C.C. NUNNALLY
by Mrs. C.C. Nunnally and Family
IN MEMORY OF MY HUSBAND:
EDWARD SMITH
by Terry Smith

November 28th
IN MEMORY OF:
BERT DENNIS
by Dorothy Dennis
IN MEMORY OF:
MR. & MRS. L.A. PEARCE
for whom the mountain was home for many years
by Delmo Pearce

November 29th
IN MEMORY OF:
BANNIE HANCOCK
by Juanda Hancock

November 30th
IN MEMORY OF:
DR. & MRS. E.E. MIDDLETON
by Ms. Marjorie M. Middleton

December 1st
IN MEMORY OF:
STERLING WILLIAMS
by Warren & Betty Beaver
IN MEMORY OF:
S.C. (BUDDY) SHARP
by Ross & Sarah Sharp

December 2nd
IN MEMORY OF:
JOHN KNOX MITCHELL FAMILY
by Warren & Betty Beaver

December 3rd
IN MEMORY OF:
EDWARD SMITH
by Warren & Betty Beaver

December 4th
IN MEMORY OF:
BETTY WILLS
by Warren & Betty Beaver

December 5th
IN MEMORY OF:
MR. & MRS. MARSHALL CRAWFORD
by Gordon F. Young

December 6th
IN MEMORY OF:
MARY D. MULLINS CARY
by Margaret Carey Billingsley

December 7th
IN MEMORY OF:
LESLIE, RUTH & GUYRENE COPELAND
by Bertie Copeland

December 10th
IN MEMORY OF:

BENO HENDRICKS
IN HONOR OF:
DONNA HENDRICKS
by Bo & Jacque Hendricks

IN MEMORY OF:
JOHN DENNIS AND DEBORAH DENNIS AWTRY
by Peggy Dennis, David Dennis, Mary Ann Awtry & Family, Mike & Jacque Whalen

December 11th
IN HONOR OF:
MR. & MRS. F.R. ALLEN
by Judy Wootan

December 12th
IN HONOR OF:
THE BORDEN JR. HIGH STUDENTS
by Judy Wootan

December 13th
IN MEMORY OF:
JAMES EUBANKS
by the Dennis Poole Family

December 14th
IN MEMORY OF:
C.C. NUNNALLY
by Mickey & Shirley McMeans

December 15th
IN HONOR OF:
JERRY & MARY CLAYTON
by M/M. John R. Anderson

IN HONOR OF:
BROOKIE & BILL ANDERSON
by M/M John R. Anderson

December 16th
IN MEMORY OF:
DR. JOHN HANNABASS, wife
KATE McCLINTON & daughter MIRIAM
by Mac Clinton Norwood

December 17th
IN MEMORY OF:
C.C. NUNNALLY
by Mr. & Mrs. T.L. Griffin

IN MEMORY OF:
JOHN DENNIS
by Mr. & Mrs. T.L. Griffin

December 18th
IN HONOR OF:
ED, LARA, JAKE & RACHAEL PAYNE
by Ed & Lara Payne

December 20th
IN HONOR OF:
SARAH BLAND, MARY HUTTO, JOHN ROBERT ANDERSON & MARY WRISTEN
by M/M John R. Anderson

December 21st
IN HONOR OF:
SARAH & ROSS SHARP
by B.A. Hopking

December 22nd
IN HONOR OF:
NAN & TOBY SHARP
IN MEMORY OF:
MARVIN KEY
by the Roland Key Family

December 23rd
IN HONOR OF:
MARGARET SHARP
by B.A. Hopking
IN MEMORY OF:
OPAL KEY
by the Roland Key Family

December 24th
IN MEMORY OF:
ARVIL (BABE) BREWER
by Ross & Sarah Sharp
IN MEMORY OF:
ALL OF OUR LOVED ONE AND FRIENDS
by the Ralph Miller Family

December 25th
IN MEMORY OF:
OUR FATHER, EDWARD SMITH
by Gerry & James Smith
IN MEMORY OF:
MY HUSBAND, EDWARD
by Terry Smith
IN HONOR OF:
LARRY HOPKINS
by B.A. Hopkins
IN HONOR OF:
THE EMPLOYEES OF BORDEN COUNTY BLESS EACH OF YOU!
by Terry Smith
IN MEMORY OF:
MORRIS LINDSEY
by Mr. & Mrs. Stanley Whisenhunt

December 26th
IN HONOR OF:
ZELLA NIXON
by B.A. Hopkins

December 27th
IN HONOR OF:
SHIRLEY & KENNETH BENNETT
by B.A. Hopkins

December 28th
IN HONOR OF:
SUE & BOB BEAL
by B.A. Hopkins

December 28th
IN HONOR OF:
CONNIE & SID HART
by B.A. Hopkins

December 30th
IN MEMORY OF:
MR. & MRS. BONNIE M. WILSON
by Rebecca, Glenn & Renee Wilson

December 31st.
IN HONOR OF:
BORDEN COUNTY EMS
by Citizens of Borden County
IN MEMORY OF:
EDWARD SMITH
by Mr. & Mrs. Stanley Whisenhunt

IN MEMORY OF:
MR. & MRS. PRESTON SHARP, PRESTON SHARP, BARBARA SHARP, MR & MRS. AUBRY ROGERS
by Margaret Sharp & Helen & Jim Warden
CORKY OGDEN, VERNON CREIGHTON
by Verna (Snooks) Ogden
DAVE R. COVEY RUBY COVEY
by D.R. & Berdette Covey
GARLAND DOYLE CLAY KINGSTON
by Eva W. Doyle
C.C. NUNNALLY
by May Stephens, Dick Tune & Joan Tune
BUDDY SHARP
by Bo & Jacque Hendricks
LORENE PETTY LEONARD PETTY
by Robert (Buz) & Pasty Petty Buzbee
BILL GILLELAND, MR. & MRS. SAM NELMS, MR. & MRS. TOM NELMS, MR & MRS. MARVIN BREWER, MR & MRS. CHURCK COURSEY, BENO HENDRICKS, KEN DON JONES, MR. & MRS. PRESTON SHARP, MR. & MRS PLES HALLMARK MR. & MRS. EARNEST ROBINSON, BARBARA LaNELL SHARP, EDWARD SMITH, MR. & MRS. W.L. HELTON
by Ross & Sarah Sharp
SKEET PORTER J. PAT PORTER
by Bob and Cookie Dyess
YORK FAMILY VELMA BURT
by Peggy York
JOHN DENNIS MR. & MRS. RAYFORD BOYD
by Terry Smith
MOM & DAD
by Judith & Greg Steward
VERNON CREIGHTON CORKEY OGDEN MARY CATHEY
by Cliff & June Durham
JOE BRADSHAW, MAYLOA BRADSHAW, BRIANA BRADSHAW, WILMER MCGREW, IRA MCGREW
by Alvin & Doris Bradshaw

IN HONOR OF:
ROSS & SARAH SHARP
by Frank & Joyce Herridge
KYLE JENNINGS DEAN JENNINGS McCRAE McCORMICK MADOLYN McCORMICK COREY COX JUSTIN COX
by Warren & Betty Beaver
TOM, SANDRA, JOE, & SUE
by Juanda Hancock
MARGARET SHARP SARAH GILLELAND
by Bo & Jacque Hendricks
SARAH L. GILLELAND MARGARET SHARP JASON SHARP DONNA HENDRICKS
by Ross & Sarah Sharp
LELA PORTER
by Bob & Cookie Dyess
OBE J. WILSON FAMILY
by Rebecca, Glen & Renee Wilson
DONNA HENDRICKS, JAMES EDWARD CLIFT, JOHN WILLIAM CLIFT, MR & MRS C.H. HYDEN, BORDEN COUNTY EMT'S, OLEITA MITCHELL, GLADYS WILLIAMS
by Terry Smith
MICHAEL "DUKE" Williams
by Kim Hendricks
VICKIE KIKER, GAYLA ERWIN, CODY NEWTON, JESSICA KIKER, LACEY NEWTON
by Doyle & Shirley Newton

IN APPRECIATION OF:
ROSS, PEG & SID WESTBROOK
by Cliff & June Durham

DONATIONS FOR THE STAR

Sam Saleh, Joel, Betty & Jeff Dennis, Dr. Harold D. Dow, Mr. & Mrs. Bill Ludecke, Mr. & Mrs. R.D. Lewis, Lone Star Federal Land Bank Association, John Saley

PARENTS CLUB MEETING

There will be a Parents Club meeting on Monday, December 13th in the school cafeteria beginning at 5:00 P.M. prior to the Jr. High Basketball games with Westbrook.

Plans need to be made for additional activities for the Holidays and for the Spring. Your attendance is needed and would be greatly appreciated.



EMS Memorials

Donations have been made to the Borden County EMS

In Memory Of:

John Dennis

by M/M Morris Lang
M/M Arlan Youngblood
Paul & Mary Ann Awtry
Billy Gannaway
Dorothy Dennis
Susy Morris
M/M Curtis Clark
Terry Smith
M/M T.L. Griffin, II

In Memory Of:

C.C. Nunnally

by Paul & Mary Ann Awtry
Joel & Betty Dennis
M/M Arlan Youngblood
Joyce Smith
M/M T.L. Griffin, II
Alvin & Doris Bradshaw
Edgar & Margarette Ray
Steve & Dorothy Barrington

In Memory Of:

Banny Hancock

by Paul & Mary Ann Awtry

In Memory Of:

Burr Lea Settles

by Larry & Sue Ringner

In Memory Of:

Laverne Clawson

by Larry & Sue Ringner

In Memory Of:

Carolyn Stone

by Bo & Jacque Hendricks
Terry Smith
Doyle & Shirley Newton
Joyce Smith
Eva Doyle
Doris Steadman

In Memory Of:

Rayford Boyd

by Terri Smith

In Memory Of:

Mrs. Roper

by Terry Smith

In Memory Of:

Wayne York

by Mark & Gayla Erwin

In Memory Of:

Paula Lewis

by Mark & Gayla Erwin

In Memory Of:

Opal Key

by Doyle & Shirley Newton

In Memory Of:

Morris Miller

by Mr. & Mrs. Frank Beaver

Gail Cemetery Fund

A donation has been made to the Gail Cemetery Fund

In Memory Of:

C.C. Nunnally

By Jo Hensley

Verna Faye Ogden

Cancer Society Donations made

A donations has been made to the Cancer Society

In Memory Of:

C.C. Nunnally

by Rich & Barbara Anderson

Harding Announces

Joe Harding of the Vincent Community announces his candidacy for Borden County Commissioner Prec. No. 3 subject to the March Democratic Primary. "Your vote and support would be greatly appreciated," stated Joe.

*For school news and information
Subscribe to the
Borden Star today!
Only \$12.00 a year*

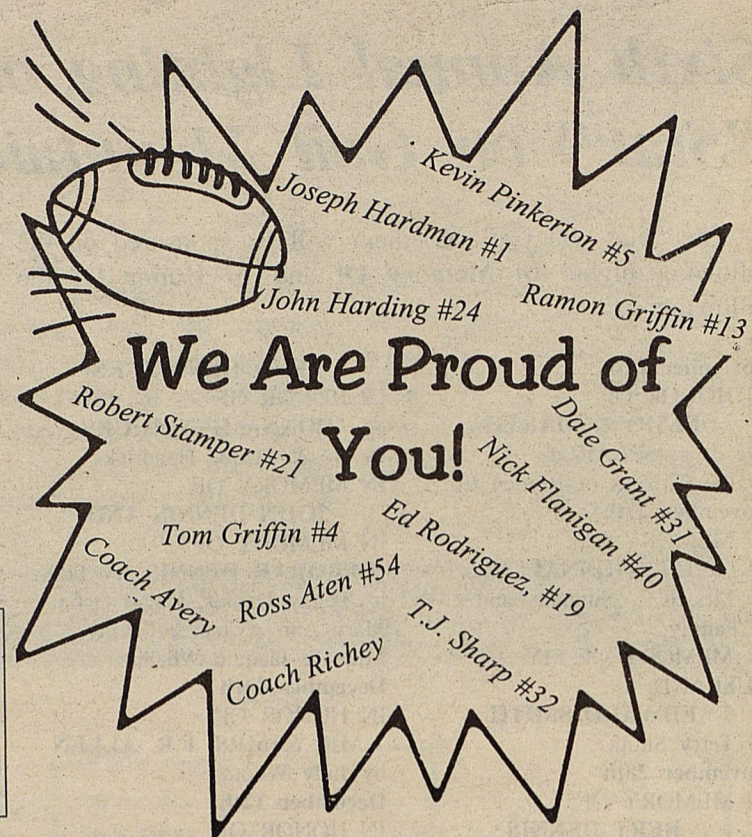

We Are Proud of You!

HEALTH FAIR

Friday, December 10 from 10:00 am to 4:00 pm
Borden County Show Barn, Gail

A fee of \$2 will be charged at the door to cover screening and material costs

Blood Pressure and **Blood Glucose** screenings will be provided by Medical Arts Home Health - Lamesa all day!
Blood Cholesterol and **Bone Density** screenings will be offered from 10:00 am to 12:00 pm only!

Blood Cholesterol screening provided by:
Texas Tech University Health Sciences Center School of Nursing
Bone Density screening (**fee of \$35**) provided by:
University Medical Center - Lubbock

Exhibits and Educational Materials available:
Diabetes information provided by Martha Foy, Diabetes Educator Medical Arts Hospital - Lamesa
Cancer information provided by the American Cancer Society
Heart Disease information provided by the American Heart Association
Breast Health, Fat in the Diet and **Living with Africanized Honey Bees** exhibits/information provided by the Texas Agricultural Extension Service

Congratulations Coyotes on a GREAT Football Season

Moore-Rains Insurance
Frances Rains Stephens
806/428-3335

BLOOD DRIVE

by United Blood Services - Lubbock
Friday, December 10 from 1:00 to 4:00 pm
Outside Show Barn

Events sponsored by the Borden County Extension Program Council and the Family & Consumer Sciences Program Area Committee.

We will seek to make all reasonable accommodations for all persons with disabilities for any of our programs or activities. We request that you contact the Extension office at (806)756-4336 as soon as possible to advise of any auxiliary aid that you will require.

Extension programs serve people of all ages, regardless of socioeconomic level, race, color, religion, sex, disability or national origin. The Texas A&M University System, U.S. Department of Agriculture, and the County Commissioner's Courts of Texas Cooperating