



Pictured are Masons who attended the Masonic installation Saturday night. Back Row: Mike Schnell, immediate Past Worshipful Master and Junior Warden; John R. Colard Jr., Past Grand Master of the State of Texas and Senior Deacon;

George R. "Bob" Scott, Grand Master of Masons in Texas; Mansel Bryan, Worshipful Master; Loyall Turner, Senior Steward.

Front Row: Roy Lee Uptergrove, Junior Deacon; Bill Stevens, Senior

Warden; Albert Graves, Treasurer; Tommy Russell, Chaplain; Raymond Kirk, Tyler; Cecil Biggers, Secretary [not pictured]; and Roy L. McClellan, Junior Steward [not pictured].



Joe Dan Bryan, Mansel Bryan and his wife Charlene were present at the open installation of officers for the Spearman Masonic Lodge, Saturday night. Mansel was installed as Worshipful Master.

## Masonic Family

# The Spearman Reporter

Volume 77 Number 37

The Spearman Reporter, Spearman, Texas 79081

Thursday, July 18, 1985

24 hr. prayer  
service 659-2911

State funds to decrease!

# Taxable values drop \$12,977,780

The Hansford County Appraisal District has certified the taxable values for Spearman I.S.D. to be \$266,370,885. That compares to a 1984 \$ value of \$279,348,665 or a loss of \$12,977,780. The bulk of the drop in values appears in the category of oil, gas and minerals, which was expected due to the economy of this industry.

To complicate the matters even further the funds the school district receives from the state will also decrease as part of the new finance and equalization package that was engineered and pushed by Governor Mark White and Ross Perot. Governor White proclaimed no new taxes, but in essence the local people will pay for his folly. State funds for Spearman I.S.D. will result in a change from the 1984-85 school year to the 1985-86 school year of \$186,000 less, due to the

equalized funding. This figure leaps to \$218,000 in 1986-87. In looking at percentages for state and local revenues the figures become depressive. In 1984-85 the state and federal funds amounted to 33.9% of total anticipated revenues, and the 1985-86 amount drops to 27.3% of total revenues. These figures clearly depict the direction of the Governor's program—make the local taxpayer carry the load, not the state.

New Superintendent of Schools, Larry Butler, feels the people of Spearman and the entire Panhandle have been railroaded by Governor White's program and will suffer the most from his "no new tax" package. True, no new state taxes, but plenty of local taxes, fees and additional registration charges. Another political charade.

## L.J. Hornsby rites held

L.J. Hornsby, 63, died Sunday. Graveside services were held Tuesday, July 16, at 2 p.m. in Hansford County Cemetery with David Fultz, minister of the Church of Christ, officiating. Burial was held by Boxwell Brothers Funeral Home.

Mr. Hornsby was born in McLean and had lived in Spearman since 1942. He was an Army veteran of World War II. He had retired from Baker and Taylor Drilling Co. He married Violet Tucker in 1945 in Spearman.

Survivors include his wife; two sons, Larry of Canyon and Clifford of Canadian; a daughter, Mary Ellen Goodwin of Divide, Colo.; three brothers, Roland of Canyon, Eddie Joe of Amarillo and Alvin of San Jose, Calif.; and five grandchildren.

## Thanks

The Spearman Ex-Students Association would like to express their sincere appreciation to Jim & Debra Brown and daughter Amanda for providing entertainment at the assembly during the reunion. They had prepared a beautiful program of religious songs and we thank them for the work they did to prepare it for us and sorry that more people did not have the opportunity to hear it. Thanks again to the Browns for helping to make the second all school reunion a big success.



Maxine Biscoe

Maxine Biscoe opens her gift presented by the Spearman Rotary Club.



Jack Biscoe

Jack Biscoe opens his gift presented by the Spearman Rotary Club.

## Museum Box Supper & Cake Walk July 26

On July 26th at 7:30 p.m. the Station-Master's House Museum will have their second annual Box Supper & Cake Walk at the Museum.

Bring a box of food for two and enjoy the evening. The Museum will furnish the cold drinks. There will be entertainment too.

The public is invited.

## Thanks

The Spearman Chemical People would like to thank the following for another successful July 4th Street Dance for our youth: Sheriff R.L. McFarlan & his department

City Police department Interstate Savings & Loan & Gordon's Drug - electricity Pride Mart - ice Thriftway - soft drinks Carlee Dixon & Norma Jean Mackie - extra effort Perry & Mary Dixon, Andy & Sheila Watley, Tam & Linda Latta - sponsors Butch Schaefer - preparation And a special thanks to all the youth that came out & celebrated the 4th with us!

# Welcome Jack Biscoe

The Spearman Rotary Club enjoyed a visit from Rotary District Governor Jack Biscoe and his wife Maxine Monday of this week. Jack and Maxine are from Midland. Jack is a member of the Midland West Rotary Club where he served as president for 1982-83. He and Maxine served as Chairmen of the Registration Committee for PDG John Seay at the 1982 District Conference. In 1983-84 Jack served as a District Representative for the then Governor John H. Selby. For the past twenty-five years Jack has had his own real estate company, dealing mostly in commercial property and land.

Last week, the Rotarians enjoyed a program presented by Bobby Brown on the Texas Gold satellite dish.

### CORRECTION

We stated in our reunion story that Anne Jackson Burch was recognized as coming the furthest to attend the reunion. She traveled 11,000 miles from Singapore, to see her classmates who graduated in 1966.

We stated in the article that Singapore was in Japan. Our apologies.

The Editor

## Dr. Sangalang now taking appointments

Dr. Sangalang will start seeing patients on Wednesday, July 17. Make your appointment on Tuesday 659-5551. Hours will be from 9-5 Hansford Clinic.

# Win a new Golf Cart -

The Hansford Golf Club is offering chances on a new golf cart. The \$100.00 donation to the club will not only give the donor a chance at winning a new golf cart but will also allow the donating couple an evening of dining and dancing.

The golf cart is now on display at the golf course. The "Golf Cart Ball" will be catered by IV's Hungry Cowboy.

In other golfing news Brian Noel, golf pro at the Hansford Golf Club announced this week that the junior golf tourney at the club will be held on July 24.

There will be no entry fee for the "Junior Golf Tournament". The Tournament is open to Hansford County residents only. Ages 10 and under, 11-13, will play 9 holes. The 14-18 year olds will play 18 holes. T-off will be at 9 a.m. Wednesday, July 24. Trophies will be awarded.

The Hansford Golf Club is extremely proud of the many people who use the club. This year the State Champion play-off Gruver boys team had all of their practice training at Hansford Golf course. The club is used by young and old alike, and if you are a golfer you are welcome to play at this beautiful Hansford County course.

## Hotel Royal announces grand opening

Hotel Royal announces their grand opening on August 3, when the open house will be held. There will be a beauty shop, barber shop, gift shop, coffee shop, meeting room on the 3rd floor, and a taxi service.

The historic building is now 76 years old.

## Keep a little romance in your marriage

By Paula Sinise

Frankly, I think romance has gotten a bad name. Romance is that mushy stuff newlyweds indulge in that makes the rest of us wish we were somewhere else...long, lingering looks, holding hands, sighs and whispers. Yuck, right?

The truth is romance is very good for any relationship. It's like powdered sugar on chocolate brownies, an attractive addition. Let's take a look at romance.

First, of course, a definition. Romance is anything that is not absolutely necessary. There is nothing romantic about brushing your teeth. However it is romantic to put toothpaste on your mate's toothbrush. Not necessary, but nice. Here's another example. It is never necessary to buy that perfect red rose bud for your love, but it is romantic. The list of romantic things you can do for each other is endless. Take a look at that definition again. Romance is ANYTHING that is not absolutely necessary.

In recent years, the market has been flooded by thousands of romance novels about perfect lovers and wonderful relationships. Why are they so popular? Studies have been done to determine what makes a perfect lover. Questions were asked from both men and women and guess what they discovered. We're hungry for romance. It's not sex appeal, good looks or money. What tops the list? "She sets aside time for me." "He's a good listener." "He remembered that I like pickled jelly beans." "Thoughtfulness, consideration and yes, romance."

I think you probably understand

what romance is by now. How can it help improve an already steady relationship? How can it stabilize a rocky relationship? Remember when you first started dating and your boyfriend always opened the car door for you. Well, you've been married ten years and you're lucky if he remembers to unlock the car door after he gets in and starts the motor. You know he loves you. You have wonderful home life and your children are the most attractive and well-behaved on the block. But he still forgets to open the door for you. Perhaps your favorite meal is fried squash with liver and onions. It's been three years, two months and nine days since your wife fixed it for you. You know she loves you, but it would be nice if she remembered to fix it. We're talking about romance. The details of caring that are above and beyond the nitty-gritty of survival in married life.

One of the things couples in counseling complain about is a disregard for details. We've heard the jokes. He squeezes the toothpaste from the bottom and she doesn't. They divorce for marital incompatibility. Being thoughtful about the little things is a part of romance, too. Taking the time to be creative in your relationship can cement your love when (or if) the passion fades from a roaring fire to a glowing coal.

Here a few suggestions for adding romance to your relationship:

1. Take a few minutes each day to talk to each other. It doesn't matter about what. Just talk.
2. Date your mate, away from

children or friends, at least once a month.

3. Try to think of a surprise for your mate (besides a new paint brush so he or she can finish the trim on the house). Little or big, it doesn't matter what it is or how inexpensive it is. Be creative. Show your mate that you're thinking about him or her.

4. Focus on the positive. Instead of remembering what he or she never does, focus on what he or she did and be openly appreciative.

5. Treat your partner as if you were still trying to impress them enough to marry you. We forget, after a few years, that partners liked to be pampered and cherished. Maintaining a long-term relationship takes work, attention to details and creativity.

6. Finally, don't be embarrassed to be tender and affectionate to your mate. It may not be fashionable in

our lovely-cynical society, but it will certainly pay off in your relationship.

Perhaps it would be a good idea to expand our definition of romance. Romance is anything that pleases, flatters, pleasantly surprises, cherishes or enhances your mate or your relationship. It is the unselfish dedication to someone else's happiness. Stated that way, even paying the bills can be romantic. So you see, romance isn't really only for newlyweds.

Paula Sinise M Ed  
Outreach Counselor  
Perryton Family Services

### MARKETS

WHEAT	\$2.85
CORN	\$3.00
MILO	\$4.75

## Moving Sale

**40%** off  
Gift Box

212 Main Spearman 659-3125

### HOSPITAL NEWS

Patients in Hansford Hospital are Ruth Gerrard, Ruth Skinner and Addie Novak.

Dismissed were Gabino Flores, Mattie Dyer, Alice Fite and John Roland.

The Station Master's House  
Museum  
Box Supper & Cake Walk  
July 28th

Israel to be out of Lebanon  
by June 1.

Mrs. and Mrs. Thane McElroy  
request the honour of your presence  
at the marriage of their daughter  
Bonnie Gayle

to

Hunter Ed Novak  
son of Dr. and Mrs. Earl Novak  
Saturday, the twenty-seventh of July  
Nineteen hundred and eighty-five  
at six o'clock in the evening  
First Christian Church  
29 South Bonice  
Spearman, Texas

Reception following

### WHERE'S THE BEEF ???

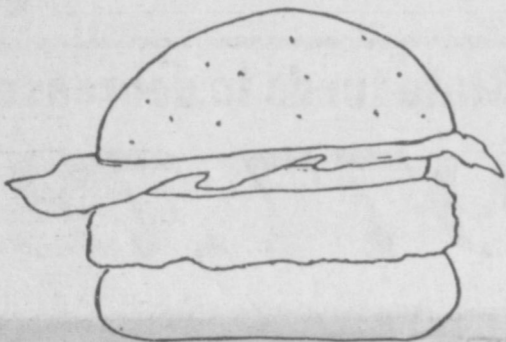

AT THE

### HAPPY DAYS DRIVE-IN!

July 19, 6:00 P.M. - 10:00 P.M.

Sponsored by the United Methodist Youth

Drive into the South Church Parking lot at 407 S. Haney and be greeted 1950's style by curb service. The car hops will take your order of grilled hamburgers, nachos, home fries, and soft drinks

For take-out orders call 659-3220 after 5:30 p.m. July 19th.

Please have supper with the Happy days Gang July 19th.

## Straight Talk

from Texas-New Mexico Power Company

### How did TNP Employee Tim Gerdes help prevent energy loss in his home?

The areas around your windows and doors may not be cracked or broken, but unless they are properly sealed, you may be letting valuable energy be lost to the outside. TNP Employee Tim Gerdes of Dickinson, Texas, found he could seal the areas around all his windows and doors quickly and easily with inexpensive caulk and weatherstripping.

You can find all types of caulking and weatherstripping at your local hardware store. The installation of the material is so simple you can do it yourself in only a matter of minutes.

Find out more ways you can prevent energy loss in your home by calling our office today!

Neighborhood Professionals  
Offering You The Best Choice

Texas-New Mexico  
Power Company.

EL 27-85

## 11.8% BANK FINANCING ON ALL NEW VEHICLES



First National Bank has the hottest financing rates in town for all new cars, pickup trucks, vans, travel trailers, and camping trailers. These may be domestic or foreign vehicles. There is no restriction on the dealer you select, nor on the size and model you choose.

You can select 36 months, 42 months, or even 48 months to pay on your new vehicle installment loan. Monthly payments are required. See the chart below for the interest rate and down payment amount for the term of your loan.

11.8% APR\* for 36 months with 20% down payment of sticker price

12.8% APR for 42 months with 20% down payment

13.8% APR for 48 months with 20% down payment

\*Annual percentage rate

This offer is not limited to current First National customers. You arrange for your own purchase price with the dealer of your choice.

First National Bank invites you to talk with our personal loan officers before you go to buy. That way you'll have your financing arranged in advance. Come by or call loan officers Roger Monzingo, Quentin Rizley, or Leby Crane. In the main lobby. Open 9:00 to 3:00, Monday through Friday.



First National Bank  
Perryton, Texas  
806/435-3676  
Member FDIC

Offer good through August 15, or upon notice by First National Bank

# BUY, SELL, TRADE OR RENT THROUGH THE CLASSIFIED ADS

**Call**  
**659-3434**

## SERVICES

New to area?  
Give us a try  
Used COW DEALER  
As soon as Possible  
659-3544  
659-3545  
1-800-692-4043  
175-rtm

## MONUMENTS

Save Agents and  
Undertakers Profits  
If it is inconvenient for  
you to visit our large  
display, please phone col-  
lect (405) 327-0626 or write  
and we will call on you.  
ALVA MONUMENT  
WORKS, INC.  
Alva, OK 73717

## NOTICE

Wallace Monument Co.  
Monuments, Curbing,  
Grave Covers  
Local Representative  
LEONARD JAMESON  
Spearman, Texas  
355-RTN

## OSGOOD MONUMENT CO.

Amarillo, Texas  
Dealers of Rock of Ages  
Granite as well as all  
colored granites, marble  
and bronze memorials.

represented by  
**BOXWELL BROS.  
FUNERAL HOME**  
**519 S. EVANS**  
**659-3802**

Hay Swathing & Baling done. Call  
733-2517 or Dennis at 733-5214.  
27s-rtm nc

APPLIANCE REPAIR: Call Jim  
Nobles, 659-3528.  
20-rtm

Hansford County  
Planned Parenthood  
412 Davis  
659-2483

Spearman, TX  
Monday-Friday  
8:30-12:30

STEAM RINSE & VAC  
Rinse and Vac Shampooer  
for rent at Gordons Drug.  
\$10.95 up to 24 hours.

SEARS BLOW-IN ATTIC  
INSULATION. Completely install-  
ed. For FREE Estimate at your  
convenience dial 659-2373. Sears,  
Roebuck and Co., 517 S. Hwy. 207.  
45S-rtm

WILL DIP and bath. dogs for fleas  
and ticks. Call Hansford County  
Veterinary Hospital for Julie for  
appointment. 9-2100.  
34S-rtm

**Tree Trimming,  
Handy Man.**  
Phone 659-3115.  
**Bill Hopper**

PANHANDLE CRISIS CENTER  
101 S. W. Furth, Perryton, Texas  
79070, 806-435/5008, 806-435-5013.  
Help is available at no charge for  
domestic violence and sexual  
assault. Call Panhandle Crisis Cen-  
ter, receive support during a  
difficult time. Counselors on call 24  
hours a day. Call for help.  
19-rtm-nc

## SERVICES

Need to oil your wood shake or  
shingle roof? Give it extra life and  
beauty.

Whatever your painting needs  
may be - from taping and textures  
to custom finishes with any coating  
on any surface. We also feature  
energywave insulating paints. Call  
today for a free estimate.

**BEASLEY PAINTING**  
ALLAN 733-2858 JIM 733-2012  
15-rtm

Snoopy's Ready or Not Wilton  
Cake decorating supplies are now  
on sale at 620 1/2 Bernice. Debbie  
just received a shipment of wed-  
ding cake tops, birthday tops;  
tuk-n-ruffle; bags; icing colors; etc.  
Now you can do it yourself or for  
Ready made cakes, cookies, or cup  
cakes call Debbie at 659-3328.  
37s-4tc

## WANTED

WANT TO BUY good long, wide  
topper. 659-2325.  
32-rtm nc

## HELP WANTED

THERE IS NO PLACE LIKE HOME  
SO GUARD IT!

Texas Army National guard has  
several openings in Pampa. Good pay  
and other benefits while you learn. A  
part-time job (one weekend a month),  
\$35,000 life insurance and a retire-  
ment plan. The GI Bill is now  
available for education.

32-19tc

HELP WANTED: fuel & propane  
delivery driver. Call Morse Oil  
806-733-2864.  
37-rtm

## REAL ESTATE

FOR SALE: Farm home, 25 miles  
SE of Spearman. 3 bdrm. 1/2  
basement, on 6 acres. Swimming  
pool, out buildings. Phone Perry-  
ton - 435-3722.  
14s-rtm

## FOR RENT

FOR RENT: 2 bedroom furnished  
trailer. Phone 9-5067 days, or contact  
Kathy at Allsup's evenings.  
34-rtm nc

For Rent: 3 bedroom party  
furnished mobile home and 2  
bedroom furnished mobile home.  
Call 659-2770 or 9-3071.  
36-rtm

FOR RENT- One bedroom house.  
659-5423.  
31-rtm

## FOR SALE

FOR SALE: 2 American Racing mag-  
wheels with Daytona tires. Size P-235  
by 60R14. 4 bolt, used only 2,000  
miles, only \$300.00. Phone 733-2629,  
Morse, Texas.  
37-2tc

FOR SALE: Pyrenees Guard Dogs  
raised with sheep 3 months old  
505-483-2646.  
37-8tp

FOR SALE: 3 bedroom, 1 1/2  
bath, central heat, ceiling fans,  
attached garage, fenced. Excellent  
condition. Reasonably priced. After  
5 p.m. 435-2219.  
27-rtm T-only

FOR SALE: Cabover Camper. 45  
HP Chrysler Motor. 16 ft. Lone Star  
Boat. 806-659-2325.  
17-rtm-nc

FOR SALE: Barrel Racing sed-  
dies \$300.00 call 659-2687.  
36s-2tc

FOR SALE: two dinette tables in  
good condition and a nearly new  
gas range with griddle in middle  
can be seen at 421 S. Dressen or  
call 659-5270.  
35-rtm-nc

ALFALFA HAY FOR SALE: Call  
Lewis Henderson 733-2517.  
27s-rtm nc

FOR SALE: Mini motor home,  
Chev. Transvan, side dinette, rear  
kitchen, color TV - and roof air  
\$9,995 excellent condition, see at  
1614 Colgate, Perryton, or call  
435-9111 after 5 or weekends.  
36s-rtm

## TO GIVE AWAY

FREE TO GOOD HOME: 3 year old  
spayed female Cocker Spaniel. Call  
after 5 p.m. 659-5012.  
37-2tp

## BUSINESS OPPORTUNITIES

EXCELLENT INCOME for home  
assembly work. For info. call  
504-646-0315 Ext. B-1633.  
35S-4tp

## PUBLIC NOTICE

Guymon Elks Supper Club is open  
to the public. Our hours are Wednes-  
day-Thursday 6-10 p.m. Friday-Satur-  
day 6-10:30 p.m. We have a Prime  
Rib Special every Friday.  
46s-rtm

WEIGHT WATCHERS meets each  
Monday at 6:00 p.m. at the Home  
Demonstration Building, Spearm-  
an, Texas.

## GARAGE SALES

GARAGE SALE: Thur. July 18. 9-5  
309 W. 12th.  
36s-2tc

GARAGE SALE: Fri. 19-Sat. 20th, 119  
South Snider, 1st house south of radio  
station, 9:00 to ???  
Ig. Pressure cooker, Electric heater,  
rug shampooer, hardback books, lots  
of nick nacks, much, much, more.  
Bargains Galore.  
37-1tp

3 FAM. GARAGE SALE: Hondo  
70 3-wheeler, stereo, large braided  
rug, housewares, baskets, deco-  
rative tins, dining chairs, coffee  
table, assorted dried flowers, cas-  
settes, boys & ladies clothes, all  
sizes maternity clothes, good ski  
clothes, some things like new. Sat.  
July 20, 9 a.m. - ? 1109 S. Archer.  
37-1tc

## CARD OF THANKS

We would like to take this  
opportunity to express our sincere  
appreciation for the prayers, food,  
cards, flowers, and each act of  
kindness offered our family, during  
the illness and loss of our beloved  
Mother, Donnie Moyer. A special  
thank you to the staff of Hansford  
Manor for the excellent care for the  
past 3 years and one for Hansford  
Hospital and Dr. Muthali for the  
care they gave. Words can never  
express our love and thanksgiving.  
May God Bless each and everyone  
of you.

Dale & Onie Moyer & Family  
Betty Dunaway & Family  
Bob & Linda Thomas & Family  
Jimmy & Jane Moyer & Family  
Donald & Lois Moyer & Family  
Ray Moyer & Family

We truly appreciate the City of  
Spearman for allowing us to put on  
the Street Dance for the second  
year & we hope to continue our  
efforts to provide a special celebra-  
tion in the future.

Judith Schaefer

We would like to thank everyone  
who furnished housing for ex-  
students during the All School  
Reunion. So many people who  
didn't attend Spearman schools  
called to offer homes for the gala  
occasion.

Nell Patterson.

George Shultz, Secretary of State;  
on leaders of U.S.-USSR  
meeting:

"...the best way to get  
acquainted is through serious,  
substantive discussion of the  
principal issues between our  
countries."

## TG&Y contest begins here

The week of July 15-20 TG&Y is  
having a company wide sales  
contest. The winner of each district  
wins \$1000.00. We at TG&Y have  
found a group of people who are in  
desperate need of help to raise  
money. This is the Panhandle area.  
Kidney patients auxiliary of the  
Dialysis Center of Amarillo. We  
plan to donate our prize money to  
this auxiliary because the people in  
the Panhandle area who are on  
dialysis will have the funds that the  
government provides them for  
medicine and travel to Amarillo 3  
times a week out in September.  
This will affect from 150 to 200

people in the 26 counties of the  
Texas Panhandle and surrounding  
area of Oklahoma and New Mexico.

Some of these people will not be  
able to continue coming to Amarillo  
for dialysis as they will have to  
choose whether to continue treat-  
ment or feed their families and they  
will choose to feed their families. A  
person whose kidneys do not  
function properly has to be put on  
the dialysis machine which consists  
of going to Amarillo 3 times a week  
for treatment which means sitting  
in a chair for 4 hours three times a  
week having their blood running  
through a machine to clean the  
poison out of their systems so they  
may live. A person whose kidneys  
have failed will only be able to live  
2 weeks without dialysis.

The family members of some of  
these patients have gotten together

to form the Panhandle area Kidney  
Patients Auxiliary. This is a non-  
profit organization with all the work  
being volunteered. We hope that  
we will be able to raise funds to be  
used for our patients in our area so  
that they may continue to live.

We urge everyone to come out  
and help us help this group of  
people and have a great time and  
enjoy some great bargains so we  
can help some not so fortunate  
people live.

Did you hear what Judge  
McClellan said to Dr. Novak  
and Dr. Cobb. "Pull the tooth,  
the whole tooth, and nothing  
but the tooth."

## VIRGINIA WHITE

Realtor  
Your Business is Appreciated  
Virginia White, Broker  
659-3841

I can't help it if I sell everything I  
list! Call me! Quality, Charm &  
Distinction can all be yours in this  
3 bdrm., 2 baths, brick home in  
excellent location. Emauculately  
clean! Fenced beautifully kept  
yards.

Building (30' x 40') on 50' lot.  
Could be turned into a home,  
office, or business.

Off-rtm by  
EMMETT R. SANDERS  
REALTOR  
\*\*\*\*\*

3 bedroom brick home,  
large living area, 1-3/4 baths,  
detached garage, choice loca-  
tion near elementary school.  
Estate settlement.  
\*\*\*\*\*

3 bedroom home, attached  
garage.  
\*\*\*\*\*

Elegant 3 bedroom, 3 bath  
home, large landscape lot.  
\*\*\*\*\*

Crawford Addition lot on  
pavement.  
\*\*\*\*\*

3 bedroom brick home on  
Steele Drive, large living area,  
central heat and air, carpeted.  
\*\*\*\*\*

EMMETT R. SANDERS  
REALTOR  
659-2516, nights 659-2601  
14-rtm T-only

## Priority II REAL ESTATE

806/659-3440

711 Wilbanks New Construction -  
4 bedroom, 2 bath, double car  
garage - F/P 1700 sq. ft. Buy Now  
- select own colors, brick, etc.  
\*\*\*\*\*

715 Dressen-Ready to move into  
on closing-New Brick Home. 3  
bedrooms, 2 baths, double car  
garage. Many built-ins.  
\*\*\*\*\*

718 Cotter-3 bedrooms, 1 bath,  
single car garage, brick, fenced.  
Ceiling fans.  
\*\*\*\*\*

426 S. Haney--3 bedrooms, 2  
baths, carpeted, built-ins, car-  
port, storage building, fenced  
corner lot. Nice.  
\*\*\*\*\*

732 Cotter--3 bedrooms, 2 baths,  
den, wet bar, fireplace, approxi-  
mately 2,000 sq. ft. patio, storage  
building and child's playhouse in  
back. Fenced.  
\*\*\*\*\*

205 Lonita--attractive 3 bedroom,  
1 bath, garage, fenced yard.  
Carpeted. Reasonable. Appoint-  
ment only.  
\*\*\*\*\*

1017 Wilmet Dr.-- Spacious 4  
bedroom, 2 story home with  
basement and fireplace. Two  
baths, fenced yard and 2 large  
storage buildings.  
\*\*\*\*\*

1018 Evans--3 bedrooms, 1 1/2  
baths, detached garage, living  
and dining room, fenced yard,  
storm windows. Lots of storage  
space.  
\*\*\*\*\*

We want your listings  
Leo K. Meyer Bob Hardy  
Broker Sales

## Century 21

### GOLDEN SPREAD REALTY

1104 Linn-Perfect throughout!  
A lot of care is shown in this  
home in a choice location. This 3  
bedroom, 1 1/2 bath home is close  
to school. Storage building is  
included!

118 Townsend-Lots Of Room For  
The Money--in this 4 bedroom, 2  
bath home. The huge lot and  
apartment in the rear make this  
an excellent buy.

1103 Townsend-New on Market  
Call to see this 3 bedroom, 1 1/2  
bath home. Has central heat  
and air, patio and attached  
garage.

102 Wanda Drive-You'll be  
Proud to Own this charming 3  
bedroom 1 bath home. It has a 1  
car garage, central heat and air  
plus new carpet.

712 Collier-Assumable 10 1/2 %  
bond money available to quali-  
fied first time buyers. This house  
has 3 bedrooms, 1 1/2 baths,  
central heat and air.

720 S. Barkley-Sprinkler system  
adds to the convenience of this 3  
bedroom home. It has a large  
garage plus a storage shed.

610 S. Haney-Remodeled 3  
bedrooms, 1 1/2 bath home. It is  
well insulated and has thermo  
windows. Call today! Price Re-  
duced.

201 W. 12th-Cute well kept 3  
bedroom, 1 bath home. It has  
new central heat and air and a  
log burning fireplace.

613 E. Kenneth-Spearman Land-  
mark-This two story rock home  
has 5 bedrooms and is on 1.07  
acres. It has a garage, storage  
building and a place for a trailer  
house.

1014 S. Dressen-Kids can walk  
to school from this 3 bedroom  
home. It has central heat and air  
and a single car garage.

204 Lonita-Bargain Buy! 3  
bedrooms, 1 bath and it has  
central heat and air.

1106 S. Haney-Reduced for  
quick sale. A 3 bedroom, 1 bath  
home with central heat and a  
single car garage. It will qualify  
for 11.6% bond money for 1st  
time buyers!

Investors--1114 S. Haney de-  
serves a look. It has 3 bedrooms,  
1 bath and an attached garage.  
Affordable!!

217 N. Brandt-See this 2 bed-  
room, 1 bath home. It has a  
single car garage and a good  
fence.

101 Wanda Drive-Move-in Con-  
dition describes this recently  
remodeled 3 bedroom, 1 1/2 bath  
home.

Want to Live in the Country?  
Call us about this 3 bedroom  
home. Price Reduced.

Jayne Helton, Broker, Owner  
435-5444

Allen Alford  
659-3034

Larry Prosper  
659-3491

T.O. Lesly  
659-2028

322 Hazelwood-Attention Invest-  
ors, this 3 bedroom home has an  
extra lot which is plumbed for a  
trailer.

306 S. Hoskins-Modular home-  
This 3 bedroom, 2 bath home is  
on a 55'x125' lot. The storage  
building is included.

416 Haney-Four Bedrooms, 2  
baths and a good location. Fruit  
trees galore.

202 N. Bernice-Four bedroom  
home with 2 baths and new  
carpet and wallpaper. This sale  
included a 14 x 80 mobile home  
which can be rented for extra  
income.

House To Be Moved-reasonably  
priced!

5th & Endicott-Corner lot,  
double-wide trailer house and  
rear apartment. Property is in  
good shape with good fences.

## COMMERCIAL

15 N. Hazelwood-Large building  
and small building, enclosed  
with fence. Present owner would  
lease back part of building.

202 N. Bernice-New Owner  
Needed for mini supermarket.  
Full line groceries, meat, deli,  
gas and ice. Established loca-  
tion.

## ACREAGE AND LOTS

1 section of irrigated farmland in  
Sherman County. It has 3  
irrigation wells and underground  
pipe. This land is priced to sell.  
Call (806)435-5444 or (806)659-  
2028.

Acres For Sale: 640 acres in  
Sherman County. 577 acres in  
wheat, 63 acres of grass. Owners  
will consider trading for irrigat-  
ed land.

Irrigated Farmland for sale in  
Ochiltree County. Paved road  
leads to this 320 acres. Barns  
and granaries included. Call for  
details.

Southeast of Spearman-400  
acres in Ochiltree County-  
approximately 300 acres of irrig-  
ated farmland plus 100 acres of  
grassland. A large 3 bedroom,  
2 1/2 bath home, a 3 car garage  
and a 40 x 80 barn are included  
in this sale.

4 Lots-South edge of Spearman-  
Corner lot 80 x 100; 3 others 64'  
x 100'. Not zoned for trailers.  
Buy 1 or all 4.

Lots-415 Endicott-Owner will  
clean!

A fresh new day ... and it is ours  
 a day of happy beginnings  
 when we, Meleah Jan Morgan  
 and Ricky Joe Howard  
 pledge our love as one  
 on Saturday, July twentieth  
 nineteen hundred and eighty-five  
 at three o'clock in the afternoon  
 Spearman Church of Christ  
 Spearman, Texas  
 Our joy will be more complete  
 if you can share in this  
 celebration of life.  
 Reception  
 immediately following the  
 ceremony at the church  
 37-1tp

### Pringle-Morse Community plans celebration

The Pringle Morse Community is having a celebration Saturday, Aug. 3 at the Morse Community Park.

All parade entries need to register with Linda Lou Lewis before 10 a.m.

The celebration will begin with a parade at 10 a.m.

The next item on the agenda is a T-ball game at 10:30 between the Blue Jays vs. Tigers.

A barbecue will be held at noon. Price for adults is \$5.50 and children \$2.50.

After the meal there will be games for preschoolers, adults, and school age children.

At 3:30 there will be a free

watermelon feed by the Morse Lions.

Parade entries will be judged and cash prizes given.

Donations for concrete floor for the pavillion built in the park may be given to Lions Club president, Bobby Tolleson. There will be horse shoe pitching tourney with cash prize at 11:30.

### June wedding unites couple

Karen Jeanette Wagner and Matthew Byron Lair were married June 8 in the home of the bride's

parents by Rev. Russ Gibbs of the First Baptist Church. Parents are Mr. and Mrs. Johnny Wagner and Mr. and Mrs. James Lair.

Honor attendants were Cindy Schneider, friend of the bride, and Phillip Lair, brother of the groom.

After the wedding a reception followed in the Wagner's home. The home was decorated with blue flowers. Cake and punch were served to the family and friends.

The couple's honeymoon trip was to the mountains in New Mexico. They now live in Dallas, Texas. Matthew is employed by Marshall Electronic Computers and Karen is employed by T.H.E. Travel Service.

### Mrs. Snider's mother dies

Cora Marie Helton, 70, died Friday.

Services are pending with Carmichael-Whately Funeral Directors.

Mrs. Helton was born in Sallisaw, Okla., and moved to Pampa in 1975 from Briscoe. She was a member of First Assembly of God Church of Briscoe. She was married to George Helton in 1932. He died in 1962.

Survivors include three daughters, Irene Snider of Spearman, Minnie Williams of San Angelo, and Ruth Durrett of Lakeview; four sons: Pat and Perry, both of Pampa, and Sam and Steve, both of Phoenix, Ariz.; a brother, C.E. Hall of Fritch; two sisters, Georgia Foster of Rollin, Okla.; and Eva Sutton of Shafter, Calif.; 31 grandchildren; and 13 great-grandchildren.

### Among The Neighbors

Guest in the Dennis Nelson household this week-end were his brother, David, and mother, Mrs. Georgia Nelson. She is from Farwell, Texas. David Nelson is employed by Halliburton Company, and returned to his post in Indonesia Monday morning. It will be at least a year before he has another leave. His family are with her people in San Antonio, and will join him August 10th.

The many friends of Travis Patterson will be relieved to learn that he was not seriously injured as a result of a horse falling with him. He was taken to the hospital in Amarillo but is back at home now. The accident occurred when he, his father, Pat, and brother, Clint, were working cattle at their Claybrook ranch. He roped a bull and somehow his horse lost his balance and fell with him. He had some tendon damage and a bone broken in his hands.

Mr. and Mrs. John Allen returned Friday from South Fork, Colorado, where they have been for about six weeks. They report excellent fishing and pleasant weather.

Mrs. Marla Booth, and children, Dana and Terrell, arrived last week, via air, from Riverside, California. They are visiting her parents, Mr. and Mrs. Jack McWhirter, and join another son, Cheston, who has been here several weeks. They have visited the Booths in Canyon, also. Charles Booth was unable to accompany his family at this time. He is a loan broker in Riverside. The Booths plan to return the latter part of July. Marla has accepted employment, to begin in September, with a firm doing portable x-rays and medical billing.

Mr. and Mrs. Bill Jackson, accompanied by their daughters, Ann Burch and Jana, and Kay Wade, visited several days last week in New Braunfels, Texas. Kay, who had been here for the

### Burkhart services held

Otis Lewis Burkhart, 65, of Alvin, died Tuesday, June 25, 1985, in the Medical Center Del Ora Hospital, Houston.

He was born on Sept. 10, 1919 in Thorndale and had been a resident of Alvin for one year. He was a former resident of Spearman.

He was a veteran of World War II, serving in the United States Army.

He was a member of the Protestant faith.

He is survived by his wife, Essie Burkhart, of Alvin; mother, Annie Burkhart of Austin; a daughter, Rosemary Tarter of Alvin; a son, Don Burkhart of Alvin; three sisters, Dorothy Stepkovitch of Austin, Leta Rowland of Houston and Grace Maxwell of Round Rock; two brothers, Raymond Burkhart of Olagah, Okla. and Floyd Burkhart of Florissant, Mo. and four grandchildren.

Funeral services were Friday in the Alvin Missionary Baptist Church with the Rev. Darrell Streeter officiating. Interment followed in the Confederate Cemetery under the direction of Froberg Funeral Home, Inc.

Pallbearers were Johnny Richey, Ricky Wilson, Gary Judkins, A.L. Knobles, Leon Smart and Ed Burkhart.

school re-union, was enroute to her home in Brownsville, and stopped off in New Braunfels to visit her husband's people. Ann is visiting in Amarillo, but will return to Spearman soon. The Jackson report that the weather was cool and pleasant there, even though it is so far south of here.

Mr. and Mrs. John Bishop have had visitors for several days. His niece and her husband, Mr. and Mrs. Don Bennett of Evans, Colorado and their grandson, Robbie Hembloom of Loveland, Colorado as well as Don's parents, the Reverend and Mrs. W.O. Bennett, of Kansas City, Missouri are here. Part of the entertainment planned for them is to attend the play "Texas" in Palo Duro Canyon Monday night.

Mrs. Grace Bruner had several family members in her home over the week-end and a partial family re-union on Sunday. Out of town guests were: Florence Bruner, Truth or Consequence, New Mexico; W.A. Bruner, Abilene, Texas; Billie Bruner, Pampa; Mr. and Mrs. Harry BeHas, Carver, Oklahoma; Anna Belle BeHas, Briscoe, Oklahoma; Mr. and Mrs. James Whitaker, Gruver. Those attending who live in Spearman were - Joyce and Harold Frost, Robin Keetch, Rich and Helen Melton, and Cincy, Cheryl Whitefield, Teddy and Jennifer.

Those neighbors concerned with the recovery of Frances Cudd after major surgery are pleased to know that she has returned home and is looking after herself. She returned from Northwest Texas Hospital on Sunday after undergoing surgery earlier in the week.

To report locals call 359-3468.

### Our Heritage of Faith

Identity in Worship. Some people have indicated their belief that food influences their life by saying, "You are what you eat." This claim may be a bit strong, but the fact is that we identify people in many ways: food, customs, work, values, etc. Christian Worship gives the believer in Jesus Christ a point of identity that can not be achieved alone. Worship talks about who we are, and where we stand with God and our neighbor.

NEXT TOPIC: More about identity in worship.

Bill Schardin, Pastor  
 Faith Lutheran Church  
 Spearman, Texas

Here's a reminder from social security. If you work and get social security checks, too, be sure to report if you will earn over the exempt amount. This year, the exempt amount is \$5,400 for those under 65 and \$7,320 for those 65 to 70. There is no limit for those 70 and over. And income from investments and pensions doesn't count, only wages you earn.

If you're nearing retirement age, you probably know you can apply for reduced social security benefits as early as 62. Or you can wait until you reach 65 and get full benefits. But no matter when you decide to retire, be sure to apply for benefits about 3 months before you want to start getting monthly checks. This allows enough time to process your application and you'll be sure to get your first check without delay.

# FIRST NATIONAL BANK

## SPEARMAN, TEXAS

### JUNIOR AND OPEN TENNIS TOURNAMENT

ENTRY FORM
ENTRY FORM

**DATE:** Junior - August 1st and 2nd 9:00 A.M.  
 Open - August 3rd and 4th 9:00 A.M.

**PLACE:** Spearman High School's new Omni courts

**BENEFACTOR:** Tournament proceeds and concessions to benefit Spearman YMCA.

**ENTRY FORM:** Junior Tournament

\$7.00 per single event, \$14.00 per doubles team.  
 Limit 3 events per person. Starting time 9:00 a.m.  
 August 1st.

	BOYS		GIRLS	
	Singles	Doubles	Singles	Doubles
12 and under	_____	_____	_____	_____
14 and under	_____	_____	_____	_____
16 and under	_____	_____	_____	_____

**NAME:** \_\_\_\_\_ **DOUBLES PARTNER** \_\_\_\_\_

**ADDRESS:** \_\_\_\_\_

**TELEPHONE:** \_\_\_\_\_

**SEEDING INFORMATION:**

Open Tournament

\$8.00 per single event, \$16.00 per doubles team.  
 Limit 2 events per person. Starting time 9:00 a.m.  
 August 3rd.

	A	B	Over 35
	Women's singles	_____	_____
Women's doubles	_____	_____	_____
Men's singles	_____	_____	_____
Men's doubles	_____	_____	_____
Mixed doubles	_____	_____	_____

**NAME:** \_\_\_\_\_ **DOUBLES PARTNER** \_\_\_\_\_

**ADDRESS:** \_\_\_\_\_

**TELEPHONE:** \_\_\_\_\_

**SEEDING INFORMATION:**

**Send entries to: First National Bank Box 337 • Spearman, Texas 79081 • Phone: 806/659-5544**

Tournament Directors: Don and Barbara Townsen, (806)435-2116

## We LOVE to SERVE you

**First National Bank of Spearman**

EACH DEPOSITOR INSURED TO \$100,000  
 FEDERAL DEPOSIT INSURANCE CORPORATION

729 W. 7th St.
Spearman, Texas
Phone 659-5544

## To God: A note of thanks

Mrs. E.A. Greever

My dear friends the head-line of these weekly articles you read in the Spearman Reporter tells you to whom the praise and thanks go for Mrs. E.A. Greever does not possess only that given by him. By his grace I am what I am and the world today would say as they did of the Apostles chosen by Jesus where did she get her lesson.

I am of a family of seven children who had good honest God fearing parents with very little of this world goods. I went to a country school, children from the school age to grown ups with only one teacher until 17 years of age then during the school term walked 1 1/2 miles to a small town, Alba., Mo. and had two years of high school teaching all that was taught at that time. This was year 1907. In a revival in 1908 I began my higher education my text book the Holy Bible, King James version the one and only I've studied since. I was deeply convicted of sins I had committed and with many tears and a Godly sorrow I repented and God forgave and I received a peace I had never before known and Gods word declares all must repent or they perish. My life was so happy with such peace I had a hunger and thirst for more of Gods righteousness. Impossible for me to try to describe to you how hungry I was and I received a satisfying portion several years later after coming to the Panhandle of Texas where my home has been ever since. In 1919 I heard the message of sanctification an experience that would be given by Jesus who gave himself for this blessing for all who had repented and come to God and in a revival by Holy Ghost ministers the three Morton Sisters in Wawaha, Texas(now Waka) I surrendered my life, soul, and body and the blood shed by Jesus cleansed my lift from the sin nature that I was borne with making me holy for Gods glory. Then I was completely made a new creature born of the spirit and so desirous to tell others the experience could be theirs and in studying Gods word was told to tarry for the Holy Ghost that would give the power to witness for

him; and in a tarry service in the home of Joe Davis in Range Okla. community He came in to abide.

How did I know he came in? Answer-He took complete control of my vocal organs and I spoke for two hours in a language I did not know and during the full two hours I was preaching or singing Gods praise. Gods word tells us when He the Holy Ghost abides we can be a witness unto the uttermost part of the world. This experience I received was in 1921 and by Gods grace I have been very careful not to grieve this teacher out of my life and How marvelous the zeal burning with in me to tell others the story of Father Son and Holy Ghost. In this life I have heard or known about many things and not know them and this is true about the knowledge of the Heavenly Father and his Son our Saviour. A vast difference in knowing them and knowing about them and now nearing 97 years of age I am still growing in grace and in the knowledge of our Lord and Saviour Jesus Christ and expect by Gods grace to finish this course of study when Jesus comes for me and this mortal body puts on immortality and glorious hope.

The following is the words of a song I wrote several years ago.

My Redeemer Liveth  
I know that my Redeemer liveth,  
I know in whom I trust today,  
I know he'll give me and glory,  
Until I have immortality.  
I know he shed his blood on Calvary,  
I know it saves from sin today,  
I know he'll come in clouds of heaven,  
To catch his waiting bride away,  
I know that he arose triumphant,  
I know he's at the throne today,  
I know he enterscend and blesses,  
And some day I'll in his image stay.

Chorus  
So I'll praise the blessed name of Jesus  
I will worship him whom I adore  
I will 'eer exalt my dear Redeemer,  
Who is calling all to mercy's door,  
I'm so happy to know this knowledge  
is for who so ever will.  
Thank you God.

## Members attend FFA convention

Mr. Durwin Hill, Executive Secretary, Texas Future Farmers of America, Texas Education Agency, Austin, Texas, announces three members of the Spearman Chapter of the FFA attended the 57th Annual Texas FFA Convention in Houston July 10-12 in the Astro Arena.

Mark Garnett, President of the Spearman FFA Chapter, Anne Marie Jarvis, Vice-President of the local chapter and Vice-President of the Top of Texas District and Kris

York, Reporter of the local chapter attended the convention and served as voting delegates and on the Courtesy Corp. The three day meeting was attended by representatives of over 920 Chapters from throughout the state and it included the awarding of advanced degrees, scholarships, and the awards to outstanding members of the Texas FFA. Also attending from Spearman were Jay York, Connie York and Gary York, Chapter Advisor.

Motivational speaker, Dan Baker from Bulverde, Texas was the key Dr. Tom Quarles, Houston Live-note speaker at the First General Session on Wednesday July 10th. Other speakers included, Mark Scharenbreich, motivational speaker, Brad Bass, Western Region Vice President of the National FFA; stock Show and Rodeo and various Texas Education Agency officials and State Agriculture Leaders. Fun night and Talent Contest was at 7:00 p.m. Wednesday.

Scholarships and awards were presented on Thursday. Stars Over Texas awards program was the highlight of the Thursday night program. On Friday the New State FFA President was elected for 1985-86, he is Aaron Alejandro, graduate of Boys Ranch High School and presently a student at Texas Tech University. The convention adjourned at noon on Friday.

SATURDAY 7/20/85 7/14/85-7/20/85 Spearman TX/REPORTER 6855 0855

CABLE	(2)	(3)	(4)	(5)	(7)	(8)	(9)	(10)	(11)	(12)	(13)	SHOW TIME
PM	ESPN	OETA	KAMR	TMC	KVII	CBN	WGN	KFDA	WTBS	CNN	TBN	SHOW TIME
	Sports Network	Oklahoma City	CH.4 Amarillo	Movie Channel	CH.7 Amarillo	Cbn Cable Net.	CH.9 Chicago	CH.10 Amarillo	CH.17 Atlanta	Cable News Net.	Santa Ana	Showtime
6:00	Sportscenter	Tulsa Week/Review(Ch 11)	Star Trek	Movie: 'State Fair'	Hee Haw	Laramie	Puttin' on the Hits At The Movies	Fame	Prog Cont'd	Sports Saturday CNN Investigative Report	Gloria a Dios	Prog Cont'd
7:00	McDonald's US Synchronized Swimming Championships	Austin City Limits	Diffrent Strokes (CC)		T.J. Hooker (CC)	Movie: 'And Then There Were None'	Movie: 'The Big Sleep'	Airwolf	Movie: 'Duel'	News/Sports/Weather	Felicidad	Paper Chase: The Big D
8:00	1985 Swimmese Spectacular from Hollywood, CA	America's Music	Gimme a Break	Movie: 'Electric Dreams'	Love Boat (CC)		Movie: 'Cagney and Lacey' (CC)			News Update Showbiz Week This Week in Japan	Hour of Power	Movie: 'Terms of Endearment' (CC)
9:00	1985 500CC Motocross World Championship	Tom Jones	Hunter		Finder of Lost Loves (CC)	Grand Prix Show Jumping	News		High Chaparral	News/Sports/Weather	Saturday Special	
10:00	Sportscenter	Dr. Who	News	Movie: 'Purple Rain' (CC)	News	Success 'n Life John Ankerberg	Twilight Zone	News	Night Tracks -Chartbusters	Pinnacle	Love Special	
11:00	NFL's Greatest Moments	Monty Python Flying Circus Sign Off	Live		'Take the High Ground'	To Be Announced		Unbecoming'	Night Tracks	News/Sports/Weather Evans and Novak	Together in Love Greg Laurie	
12:00	PKA Full Contact Karate: Fight TBD from Denver,		Dance Fever	Movie: 'The Last Starfighter'		Famine: Emergency Alert				News Update On the Menu CNN Investigative Report	Forerunner	Movie: 'Staying Alive' (CC)

Robert McFarlane, National Security Affairs adviser, on fate of 7 Americans held in Lebanon: "I would expect we could work together. He (Assad) is in a position to influence their release."

Brazil's President Neves dies at age 75 after seven operations.

## ATTENTION SPEARMAN GRADUATES

You've heard that tuition has tripled at four-year colleges and universities--not so at Frank Phillips College where tuition remains at a low \$10 per semester hour for out-of-district students.

Compare FPC's costs with any other college: (based on 15 semester hours)

Tuition	\$150
Fees	103
Books	150
Dormitory	200 (\$50 refundable deposit)
Meal Ticket	545
<b>\$1148 total cost per semester</b>	

In addition, Frank Phillips College will guarantee your total expenses for tuition, fees, books, dormitory, and meal ticket will not exceed \$999 for one semester; and FPC will give you a scholarship to cover everything above \$999.

This special scholarship will go to only the first ten respondents from Spearman on a first-come-first-served basis.

At FPC we offer classes designed to prepare for the shortest route to a career--one and two year intensive training programs in nursing, agriculture, computers, cosmetology, business and radio/tv.

We also offer a full range of courses in the humanities, sciences, social sciences, communications, and mathematics for easy transferability of credits to four year colleges and universities.

If you're looking for quality instruction, a wide range of programs, low tuition, well equipped facilities, a four day class week, and developmental studies to help attain a skill level to succeed in college-level work, Frank Phillips College is the place for you.

## FRANK PHILLIPS COLLEGE

For further information, send this coupon to: Dean of Students, Frank Phillips College, P. O. Box 5118, Borger, TX, 79008-5118, or call 806-274-5311.

NAME: \_\_\_\_\_  
ADDRESS: \_\_\_\_\_ City State Zip

# WAL-MART in Dumas NOW OPEN

- ★ Low Prices Every Day
- ★ Huge Selections Famous Brands
- ★ Great Unadvertised Specials
- ★ 100% Guaranteed Satisfaction
- ★ One-Stop Shopping

Low Prices Every Day, That's Real Savings... That's "THE WAL-MART WAY"



Conveniently Located  
Guy Lane Plaza  
S.W. Dumas Ave. & 14th Street  
DUMAS, TEXAS

Prices in effect  
July 19 and 20 only

Merchandise limited to stock on hand.  
Limited quantities.  
Sorry, no rainchecks.

Copyright 1985, TG&Y Stores Co.

**TG&Y**  
Family Centers

Items Available At  
TG&Y Family Centers Only

A HOUSEHOLD  
INTERNATIONAL COMPANY

# Sidewalk



**.69** quart  
Havoline HD30 Motor Oil to keep your car's engine in shape. Protects from wear and rust with friction-fighting additives. Stock up at this low, low price.

An 11-piece  
Patio Set  
for under \$50  
**49.99**

Summer is not over yet! There's still time to enjoy this Outdoor Set for your patio. The set includes a 36" table, 4 chairs, 4 hinged cushions, a 6-foot umbrella and a matching table cloth. Sold only as a set. Umbrella stand not included.



## Fashion Clearance for the entire

# 30-50% off

- Men's Coordinated Activewear Tops and Shorts to keep up with his active lifestyle
- Men's Shorts Hurry in and buy several pair from a selection of styles, colors and fabrics
- Boys' Shorts Choose from selected styles in ready-for-action colors
- Boys' Fashion Coordinates Keep him looking good all season with an assortment of tops and pants
- Infants' and Toddlers' Spring and Summer Coordinates
- Infants' and Toddlers' Spring and Summer Separates
- Girls' Sundresses Choose from solids, stripes or prints in several styles
- Ladies' Sundresses Keep cool with this wide selection of styles and colors
- Ladies' Summer Tops and Shorts A bright assortment to mix and match
- Ladies' Selected Dorm Shirts and Baby Dolls
- 1/3 Off Selected Summer Fabric

\*% off regular retail prices

521 S. HWY. 207

**Spearman, Texas**

659-3741



Prices in effect  
July 19 and 20 only

Merchandise limited to stock on hand.  
Limited quantities.  
Sorry, no rainchecks.

# TG&Y

## Family Centers

Items Available At  
TG&Y Family Centers  
Listed Below Only

Copyright 1985, TG&Y Stores Co.

A HOUSEHOLD

INTERNATIONAL COMPANY

# Sale

### For 2 Days Only

The sidewalks are sizzlin' with savings during TG&Y's unbeatable summer clearance. Shop early for your best selection.

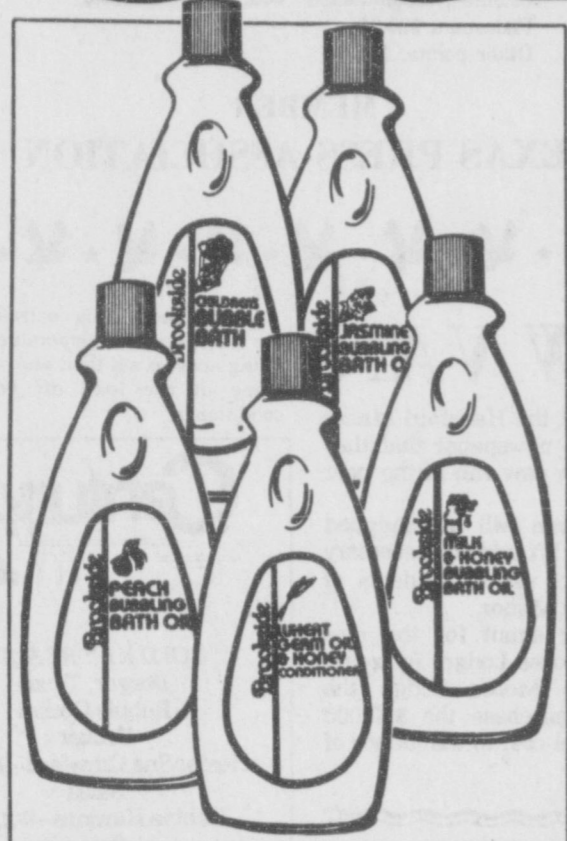

**3 \$2**  
3 bottles 32 ounces each  
Your choice: Bubble Bath, Lotion, Bath Oil, Baby Shampoo, Balsam/Protein or Wheat Germ Oil & Honey Shampoo or Conditioner.



**2 \$5**  
2 cans  
Nutcracker Fancy Whole Cashews for a nutritious snack. 11 ounce can.  
**.73**  
8 ounce bag  
Ranch Fries Potato Chips are rugged cut chips with lots more flavor. Choose plain, cheese or barbecue.



**1.44**  
6-pack\*  
Refreshing Coke, Diet Coke, Tab or Sprite in 12 ounce cans. Keep plenty on hand for your family's summer thirst. Sprite not available in all markets. \*8-packs substituted in some markets at a comparable price.

## family. Hurry in for the savings!

### 30-50% Off\*

- Wide selection of summer Shoes and Sandals for your entire family. You'll find just the styles you need from dressy to casual, for work or play. All at excellent values for summertime wear.

### 1/3 Off\*

- Infants and Toddlers Playwear
- Maternity Wear Not available in all stores.
- Selected summer Handbags

### 40% Off\*

- Men's and Boys' Caps and Visors  
A wide assortment for fishing or playing baseball. All in a selection of bright colors and different designs. At this sidewalk sale savings, you'll want to buy several.

### 30-50% Off\*

- Entire Stock of Men's, Boys', Ladies' and Girls' Swimwear
- Entire Stock of Ladies' Short Sets Great go-togethers in popular styles, colors and fabrics.
- Kids' summer Rompers

\*% off regular retail prices

521 S. HWY. 207

# Spearman, Texas

659-3741



THURSDAY 7/18/85

7/14/85-7/20/85

Spearman TX/REPORTER 6855 0862

CABLE	[2]	[3]	[4]	[5]	[7]	[8]	[9]	[10]	[11]	[12]	[13]	SHOW TIME
PM	ESPN	OETA	KAMR	TMC	KVII	CBN	WGN	KFDA	WTBS	CNN	TBN	
	Sports Network	Oklahoma City	Amarillo	Movie Channel	Amarillo	Cbn Cable Net.	Chicago	Amarillo	Atlanta	Cable News Net.	Santa Ana	Showtime
6:00	Sportscenter	Nightly Business Report	News	Prog Cont'd	News	Guns of Will	Private Benjamin	News	Sanford and Son	Moneyline	Praise the Lord	Prog Cont'd
6:30	ESPN's Speedweek	ESPN's Speedweek	M*A*S*H	Wheel of Fortune	Wheel of Fortune	Cisco Kid	Soap	Three's Company	Major League Baseball	Crossfire		
7:00	Trapshooting	Wild America (C)	Cosby Show	Movie: 'Smokey and the Bandit III'	Movie: 'The Goodbye Girl' (CC)	Here Come the Brides	Movie: 'The African Queen'	Magnum, P.I.	Atlanta at New York Mets	Prime News	Behind Scenes Short Program Alleluia	Movie: 'Conan the Destroyer' (CC)
7:30	1985 British Open Golf	Fawcety Towers	Family Ties									
8:00	Championship from Sand-	Great Railway Journeys of the World	Cheers	Night Court		700 Club		Simon & Simon (CC)		Larry King Live	Dwight Thompson	
8:30	England - First Round											
9:00		All Creatures Great and Small	Hill Street Blues	Movie: 'Newerending Story' (CC)	20/20 (CC)	My Little Merpie	News	Knot's Landing (CC)	Movie: 'Grizzly'	Evening News	Praise the Lord	Brothers (CC)
9:30												Bizarre (CC)
10:00		Dr. Who	News	News	News	Bill Cosby Show	Second City TV Cannon	News		Moneyline	Praise the Lord	Movie: 'Last Embrace'
10:30	Sportscenter	Hooked on Aerobics	Best of Carson	Movie: 'The Omega Man'	Rockford Files	Best of Groucho		Berney Miller		Sports Tonight		
11:00	Splash: Swimwear '85	New Literacy				Bill Dana		New Avengers		Newsnight	Praise the Lord	
11:30	Bowling: Bud Hall of Fame	New Literacy	Late Night with David		ABC News Nightline	Love That Bob	Movie: 'Task Force'		Movie: 'His Majesty O'Keefe'			Movie:
12:00	ESPN's Speedweek	Sign Off	Letterman		Mary Tyler Moore	I Married Joan		Movie: 'Dead Wrong'		Crossfire	Behind Scenes	'Little Darlings'
12:30	ESPN's Horse Racing Weekly		Muppet Show	Movie: 'Screwballs'	Mary Tyler Moore	Dobie Gillis				Newsnight Update	Heroes of the Faith	

FRIDAY 7/19/85

7/14/85-7/20/85

Spearman TX/REPORTER 6855 0863

CABLE	[2]	[3]	[4]	[5]	[7]	[8]	[9]	[10]	[11]	[12]	[13]	SHOW TIME
PM	ESPN	OETA	KAMR	TMC	KVII	CBN	WGN	KFDA	WTBS	CNN	TBN	
	Sports Network	Oklahoma City	Amarillo	Movie Channel	Amarillo	Cbn Cable Net.	Chicago	Amarillo	Atlanta	Cable News Net.	Santa Ana	Showtime
6:00	Sportscenter	Nightly Business Report	News	Prog Cont'd	News	Branded	Making of Mad Max: Beyond Thunderdome	News	Sanford and Son	Moneyline	Praise the Lord	Prog Cont'd
6:30	NFL Yearbook: Kansas City	NFL Yearbook: Kansas City	M*A*S*H	Wheel of Fortune	Wheel of Fortune	Cisco Kid		Three's Company	All In the Family	Crossfire		
7:00	NFL Yearbook: San Diego	Washington Week/Review	Movie: 'Return 3'	Movie: 'The Stone Boy'	Webster (CC)	Lone Ranger	Movie: 'The Maltese Falcon'	Dukes of Hazzard	Major League Baseball: Atlanta at New York Mets	Prime News	Behind Scenes Short Program Joy of Music	Movie: 'Purple Rain' (CC)
7:30	1985 British Open Golf	Wall Street Week			Comedy Factory	Great Adventure						
8:00	Championship from Sand-	Capital Journal			Benson (CC)	700 Club		Movie: 'Hotline' (CC)		Larry King Live	Ever Increasing Faith	
8:30	England - Second Round	McLaughlin Group			People Do Craziest Things							
9:00		Profiles in Amer. Art	Miami Vice	Movie: 'The Ultimate Warrior'	Matt Houston (CC)	Jack Benny Show				Evening News	Praise the Lord	Movie: 'The Pope of Greenwich Village'
9:30		Market to Market							Movie: 'Three'			
10:00		Dr. Who	News	News	News	Bill Cosby Show	Major League Baseball: Chicago Cubs at San	News	Hours to Kill	Moneyline	Praise the Lord	
10:30	Sportscenter	Sneak Previews	Best of Carson		Rockford Files	Best of Groucho		Berney Miller		Sports Tonight		
11:00	Top Rank Boxing from Atlantic City, NJ	Sign Off		Movie: 'A Clockwork Orange'	ABC News Nightline	Love That Bob	Francisco	Movie: 'Ator: The Fighting Eagle'	Night Tracks	Newsnight	Praise the Lord	D.C. Beach Party
11:30		Friday Night Videos										
12:00					ABC Rocks	I Married Joan				Crossfire	Behind Scenes	Movie: 'Romantic Comedy'
12:30					Mary Tyler Moore	Dobie Gillis		Sign Off		Newsnight Update	Religion	

S. African government repeals law forbidding interracial marriages.

Supreme Court gives CIA power to protect its sources.

Senator-astronaut Garn said his mission was successful.

## Spearman Reporter

PUBLICATIONS (USPS 6096-6000)  
SPEARMAN, TEXAS 79081  
213 Main Box 458 659-3434  
Published Weekly at 213 Main Street  
Spearman, Texas 79081  
Owner-Publisher.....William M. Miller  
Editor .....Faye Lynch  
Second Class postage paid at Spearman, Texas  
79081

Any erroneous reflection upon the character of any person or firm appearing in these columns will be gladly and promptly corrected upon being brought to the attention of the management.

POSTMASTER: Send address changes to Spearman Reporter, Box 458, Spearman, Tx. 79081.

SUBSCRIPTION RATE: Hansford, adjoining counties, combination with the Hansford Plainsman \$26.28  
Other points, \$31.54

MEMBER

TEXAS PRESS ASSOCIATION

## NEW VAN

Officials at the Hansford Manor informed the newspaper that they will receive a new van in the near future.

The new van will be equipped with a chair lift and all necessary equipment for use of residents of the Hansford Manor.

Purchasing agent for the new van is the Moose Lodge. By going through the Moose Lodge the Manor can purchase the \$30,000 van for a total cost to the manor of \$8,100.

The Station Master's House  
Museum  
Box Supper & Cake Walk  
July 26th

A thermostatically controlled attic fan will keep attic temperatures from rising above a set limit and will take some of the load off your air conditioner.



GOLD KEY REALTY  
Borger, Texas  
Bobbie Corbet  
Broker  
Hester Sue Crawford-9-2074  
Sales  
Debbie Hawkins-9-2288  
Sales

Equal Housing Opportunity  
INDEPENDENTLY OWNED AND OPERATED

**BORDEN'S**  
**HI-PRO**  
**MILK**



**\$1.09**

1/2 GAL. CTN.

**CAFFEINE FREE COKE,**  
**CAFFEINE FREE DIET COKE,**  
**COCA-COLA, OR TAB**  
**AND**  
**INTRODUCING**  
**NEW CHERRY COKE**

**\$1.79**



6 PAK  
12 OZ. CANS

**COOKED FOOD SPECIAL**

**FRESH COOKED**  
**BUTCHER BOY**  
**LONG BURRITOS**

**99c** EACH

**ASSORTED FLAVORS**  
**BORDEN'S**  
**SHERBET**



**\$1.49**

1/2 GAL. CTN.

**PRICES EFFECTIVE**  
**JULY 18-20, 1985**

**OPEN 24 HOURS A DAY**  
**GROCERIES-SOFT DRINKS-**  
**SNACKS-HOT COOKED FOODS-**  
**SELF SERVE GAS-MONEY ORDERS**  
**WHILE SUPPLIES LAST**

**ALLSUP'S**  
CONVENIENCE STORES

Clinic to be opened 17 of July, 1985

**Dr. Romeo B. Sangalang**

General Practice & Surgery

Office at 721 S. Evans

**Office Hours:**

10:00 a.m. - 12:00 Noon

Monday thru Friday

1:00 p.m. to 5:00 p.m.

Monday thru Friday

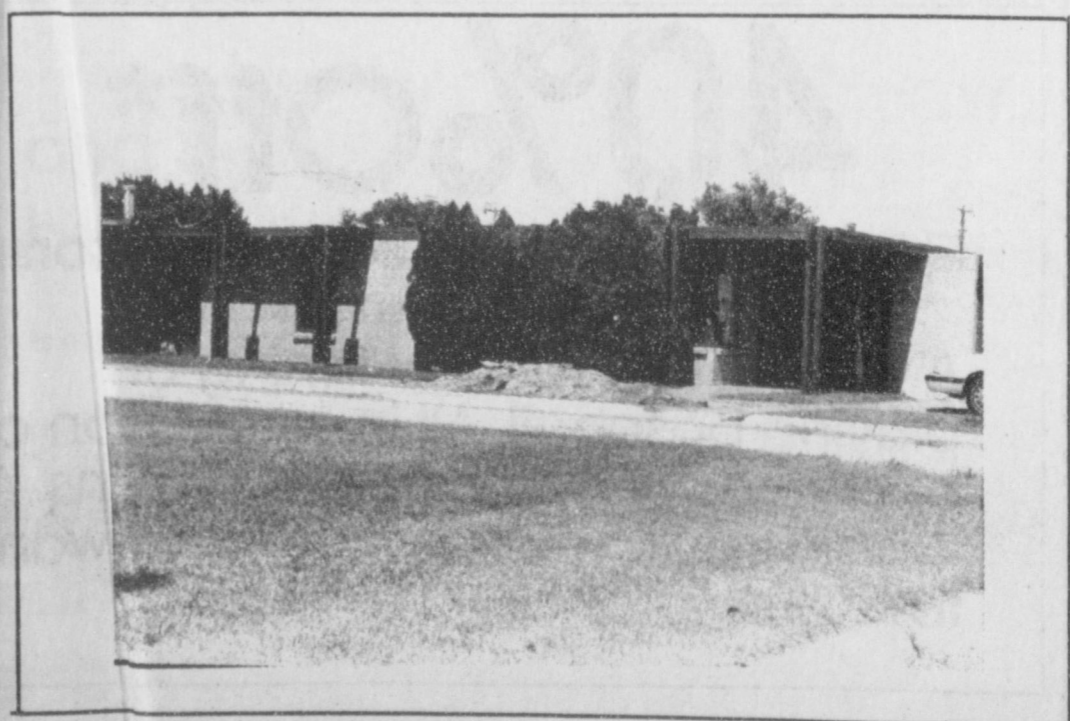

**Office Phone 659-5551**

Spearman, Texas



SATURDAY 7/20/85

7/14/85-7/20/85

Spearman TX/REPORTER 6855 0864

CABLE	[2] ESPN	[3] OETA	[4] KAMR CH.4 Amarillo	[5] TMC	[7] KVII CH.7 Amarillo	[8] CBN	[9] WGN CH.9 Chicago	[10] KFDA CH.10 Amarillo	[11] WTBS CH.17 Atlanta	[12] CNN	[13] TBN	SHOW TIME
7:00	Unlimited Hydroplane Racing		Snorks	Prog Cont'd	Superfriends	Dr. Robert Schuller and the Hour of Power	U.S. Farm Report World Tomorrow	Biskitts Get Along Gang	Cimarron Strip	News/Sports/Weather Big Story	Westbrook Hospital Saturday Special	Movie: 'Cynara'
8:00	NFL's Greatest Moments: NFL's Greatest Runners	Quilting	Smurfs	Movie: 'Electric Dreams'	Mighty Orbits Turbo-Teen	James Robison Ed Young	Garner Ted Armstrong Issues Unlimited	Muppet Babies Dungeons & Dragons	Championship Wrestling	News Update Health Week Money Week	Together Again	Movie: 'Cimarron'
9:00	Sportscenter	Frugal Gourmet	All New This Old House		Rubik the Amazing Cube	Cisco Kid	Charlando	Bugs Bunny/Road Runner	from Georgia	News Update Showbiz Week Style With Eise Klench	Toddler's Friends Gospel Bill Show	
10:00	NFL's Greatest Moments: More Than a Game	Do It For Yourself New York's Master Chefs	Kidd Video Mr. T	Movie: 'The Hunter'	Scary Scooby Doo Mysteries	the Lady	Wild Kingdom	CBS Story-break (CC) Land of the Lost	Beck	News Update Sci-Tech Week Baseball '85	Joy Junction	
11:00	Horseshow Jumping: I Love New York Grandprix	Justin Wilson La. Cookin' Victory Garden	Amazing Spiderman Incredible Hulk		PGA Golf: British Open	Laredo		Bugs Bunny/Road Runner Saturday Supercade		News/Sports/Weather Evans and Novak	One Way Game	Movie: 'Terms of Endearment' (CC)
12:00	from Lake Placid, NY Auto Racing '85: ARCA	Oklahoma Gardening Market to Market	Inside Look Major League Baseball: Oakland at	Movie: 'The Last Starfighter'		Movie: 'Pawnee'			'Tap Roots'	News/Sports/Weather Newsmaker Saturday	Meadowlark Lemon Sports Magazine	
1:00	Fram Autolight Challenge	Movie: 'Sitting Pretty'	Toronto/Kansas City at Baltimore		Nashville Music	Call of the West	Movie: 'Mob Town'			News Update Health Week Style With Eise Klench	Treasures Out of Darkness Solo Act	Star Spangled
2:00	Cycling	Sneak Previews		Movie: 'Deal of the Century'	Kung Fu	Movie: 'Phantom Gold'			Movie: 'Carson City'	News Update Your Money Countdown to Victory	Deal World	Country Party
3:00	Professional Bowlers Association - \$115,000	Disappearing World	Major League Baseball: Atlanta at New York Mets		Wide World of Sports	Wyatt Earp	America's Top Ten Soul Train			News Update Sports Big Story	Today in Bible Prophecy Behind the Short Subject	Movie: 'Staying Alive' (CC)
4:00	Tucson Open	Nova (CC)	or Pittsburgh at San Diego	Movie: 'Conan the Destroyer' (CC)			26 Miles for Darlene	Sports Inside Out (CC)	Fishin' w/Orelando Wilson Motorweek Illustrated	News/Sports/Weather Newsmaker Saturday	Up on Melody Mountain Dottie Rambo Magazine	
5:00	Racing: Bud Thunder Sosen's Salt Water Journal	Smithsonian World (CC)			ABC News (CC) News	The Monroes	Little House on the Prairie	Vegas	World Championship Wrestling	News/Sports/Weather Pinnacle	Luger Secreto Spanish Believers Voice	Movie: 'The Neverending Story' (CC)

### Boulter sees signs of hope in Budget Negotiations

After an Oval Office meeting which lasted almost two hours, Congressman Beau Boulter said he felt that "there may still be hope for a true deficit reducing budget before the end of the fiscal year."

Boulter was one of 26 House/Senate Budget Conference Committee members who met with President Reagan in an attempt to break the logjam that the Conference had come to over two primary issues: Social Security Cost-Of-Living-Adjustments (COLAs) and Defense. While no concrete agreement resulted from the meeting, Boulter noted that the Conferees seemed to have reached agreement on a budget "framework."

"We have now got four critical points under control. First, COLAs will not be frozen. Defense spending will be maintained at 1985 levels, which actually means about a \$6 billion cut from the President's original request, but spending authority will increase with inflation. Various domestic spending programs will be reduced, and finally, the President once again assured us that there will be no tax increase."

Boulter, who delivered a letter to the President in April with 146 House Republican signatures promising to

uphold a Presidential veto of any tax increase legislation, said he was particularly pleased by the President's strong assurances against tax increases. "The President told us that in 1982, he was promised that for every \$1 in taxes, he would get a \$3 reduction in spending. That didn't happen—in fact, just the opposite happened. And he will not let that happen again. We simply cannot continue to increase taxes that wind up going to finance domestic programs that have minimal public support, but are protected by big spenders in the House of Representatives", Boulter said.

When the Conference Committee reconvenes this week Boulter said the real battle will be over the ability of House Conferees to "bite the bullet" and begin consideration of federal program terminations and phase outs. The Senate budget had proposed 13 programs for termination, while the House budget contained only one. Boulter noted that "any real structural reform, and concrete deficit reduction, will have to include termination. The people in the 13th District have told me they want to see programs terminated, and I plan to make that voice heard to the Budget Conferees."

### Hot, dry weather hikes water use

Summertime heat and lack of rain are pushing water consumption for Spearman in July above most of our average days. On July 10, 1985 Spearman set a record water consumption of 2,344,000 gallons. The old record, ironically enough was set July 10, 1980 which was 2,302,000 gallons.

On most July days — the summer holiday is an exception — city water customers are turning on faucets daily to give thirsty lawns and gardens a drink.

Daily consumption and city well pumping to meet the demands have consistently run at hot weather levels, city manager Jim Murray reports.

It is interesting to note that the lowest pumping day for 1984 was

Nov. 23 with 376,000 gallons. On December 31, 1978 Spearman consumed only 283,000 gallons. The last twelve months, from July to July Spearman has averaged 771,000 gallons of water daily.

With use up to summertime levels the 4 active city wells are being pumped to keep storage tanks full, says Murray. Pumps are often running several hours a day to fill the cities 360,000 gallon elevated water storage tanks plus 1,000,000 gallons ground storage tanks.

Total storage is 1,360,000 gallons. The capacity is necessary for two reasons: to meet the water needs of city residents and provide adequate fire protection.

### USA Teen Miss Pageant

The U.S.A. Teen Miss Scholarship Pageant is coming to Texas with the state pageant festivities being held in the grand ballroom of the Hyatt Hotel in Austin on Sunday, Sept. 8th.

Girls in grades seven thru twelve that would like to represent their area in the official state finals, may receive an application by submitting a self-addressed, stamped envelope to: Texas Teen Miss Applications, 24 Delay Street - Suite 3, Danbury, Conn. 06810, or by calling the national headquarters at 203/748-6682.

Each girl accepted as a contestant will receive a tiara and sash and will officially represent the pageant in parades and other local activities during their one year reign.

Contestants will compete for the state title and crown in Evening Gown, Interview and Communications Competitions. The winner will

receive a self-study modeling course and trophies will be awarded to the court-of-honor; plus, numerous recognition awards.

The newly crowned Tex. State Winner will go on to compete with 49 other state finalists in the New York City National Finals where she will be competing for \$10,000 in awards.

The Station Master's House Museum  
Box Supper & Cake Walk  
July 26th

Mary Hatwood Futrell, National Education Asso. President:  
"The education reform movement will hit a dead end unless steps are taken to make teaching more attractive."

### Commissioners amend 86 budget

The Hansford County Commissioners Court met in regular session Monday, July 8th in the Hansford County Courthouse.

The minutes of the last meeting were read and the bills were approved for payment.

The commissioners approved the firefighters contract. They also approved the communication telephone lines S.W. of town. A pipeline for Phillips Petroleum in the S.W. end of town was also approved by the commissioners. The contract for the Hansford Library was approved.

The commissioners discussed the liability and casualty insurance for the courthouse. It was decided to ask for bids. They discussed the hospitalization insurance, but took no action.

The salary was set for the employee in the Sheriff's Department by the commissioners.

The new budget for 1986, that is effective from October 1st thru to September, was set by the Commissioners. They amended the 1986 budget to cover the cost of the chair lift that was installed in the courthouse.

The meeting was then adjourned.



### NEWS VIEWS

Ronald Reagan, President:  
"The United States give terrorists no rewards and no guarantees. We make no concessions. We make no deals."



Master Of Education Degree for the Borger & Pampa Areas

Wayland Baptist University will offer courses leading to the Master of Education degree starting in September 1985. If you would like additional information about the program, please complete the form below.

#### Requirements For The M.Ed. Degree

- \* 18 Semester Hours in Core Education Courses
- \* 12 Semester Hours in Specialization Courses
- \* 6 Semester Hours in Electives

NAME \_\_\_\_\_

ADDRESS \_\_\_\_\_

CITY \_\_\_\_\_ STATE \_\_\_\_\_ ZIP \_\_\_\_\_

SCHOOL DISTRICT \_\_\_\_\_

GRADE LEVEL YOU TEACH \_\_\_\_\_

SUBJECT AREA \_\_\_\_\_

Your Interest In Obtaining A Master's Degree  
(circle one) HIGH LOW

Do You Have Any Graduate Credit Now?  
YES NO If so, how many hours? \_\_\_\_\_

Please Clip And Mail To:

Dr. Harold Temple  
WAYLAND BAPTIST UNIVERSITY

1900 W. 7th \* Plainview, TX 79072 \* (806) 296-5521

THE INSIDE STORY OF WHY CHAMCO STANDS ALONE IN THE WORLD OF HEARING AID TECHNOLOGY

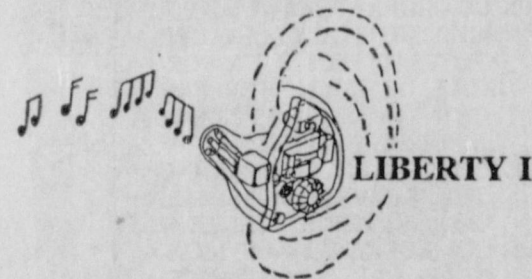

CHAMCO HEARING INSTRUMENTS Home of the "Liberty Series" world's first twin speaker I.T.E.

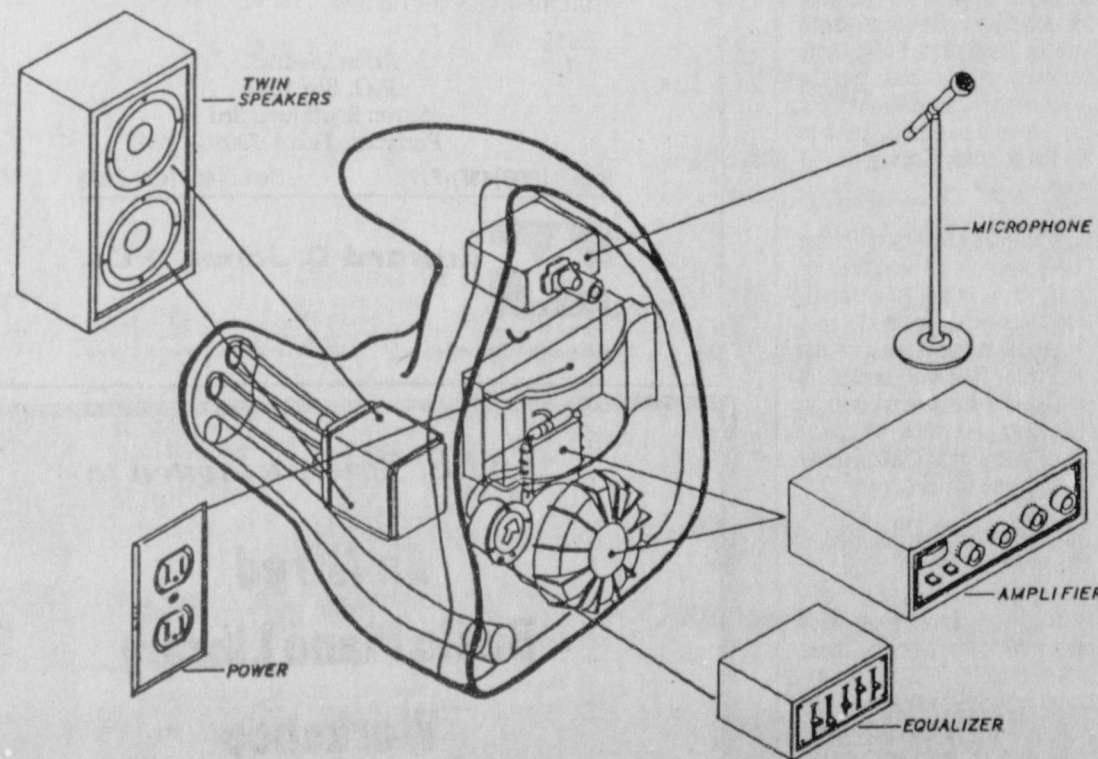

A PERSONALIZED-CUSTOM ENGINEERED HEARING INSTRUMENT DESIGNED TO SERVE YOUR PERSONAL HEARING NEEDS. FITS ENTIRELY INSIDE YOUR EAR COMFORTABLY AND IS HARDLY NOTICEABLE. IF YOU ARE LOOKING FOR THE BEST IN HEARING HELP...

YOU ARE LOOKING AT IT!

WE HIGHLY RECOMMEND IT!

FREE HEARING TEST

MONDAY, JULY 22 10:00 - 4:00

Spearman Senior Citizen Appointments Call 659-3866

High Plains Professional Hearing Aid

Jerry Lile H.A.S.

A.W. McGinnas M.S. A.C.S.

Certified Hearing Aid Audiologist

FREE HEARING TEST AVOID WAITING please call first



## Social Security News

If you need information about how to apply for a social security number... or how to get social security payments... or if you have a question about social security, here's a good suggestion. The best place to get accurate, up-to-date information is directly from your social security office. You can call or write. Someone there will be glad to answer your questions and send you a free copy of any social security pamphlet.

Do you employ a household worker? If so, you may have to deduct social security taxes from the wages you pay. You must deduct social security taxes and report the wages if you pay \$50 or more cash in a 3-month calendar quarter to a household employee. Remember, wages as little as \$4 a week add up to \$50 a quarter. For more information, call any social security office.

### Agenda

CITY OF SPEARMAN  
AGENDA  
TUESDAY, JULY 16, 1985  
8:00 P.M.

- PLEDGE AND INVOCATION.
- CONSIDERATION OF THE MINUTES OF REGULAR CITY COUNCIL MEETING HELD ON JUNE 11, 1985.
- CONSIDERATION OF THE HANSFORD COUNTY APPRAISAL DISTRICT'S 1984 AUDIT AS PRESENTED BY CHIEF APPRAISER, ALICE PEDDY.
- CONSIDERATION OF RESOLUTION #7-85 A RESOLUTION APPROVING THE CHANGE OF THE FISCAL YEAR OF THE HANSFORD COUNTY APPRAISAL DISTRICT.
- CONSIDERATION OF RESOLUTION #8-85 A RESOLUTION APPROVING STAGGERED TERMS FOR THE BOARD OF DIRECTORS OF THE HANSFORD COUNTY APPRAISAL DISTRICT.
- CONSIDERATION OF HANSFORD COUNTY APPRAISAL DISTRICT'S PROPOSED 1986 BUDGET.
- CONSIDERATION OF ACCEPTING ALPHA LOT SERVICE'S QUOTATION FOR CRACK-FILLING THE CITY HALL PARKING LOT AND HANEY STREET FROM 7TH TO 8TH STREETS IN THE AMOUNT OF \$2,288.00.
- CONSIDERATION OF RENEWING A CONTRACT WITH THE HANSFORD COUNTY LIBRARY TO PROVIDE LIBRARY SERVICES TO SPEARMAN CITIZENS.
- CONSIDERATION OF AUTHORIZING THE CITY MANAGER TO TAKE BIDS FOR A NEW ROOF ON CITY HALL.
- CONSIDERATION OF AUTHORIZING THE CITY MANAGER TO TAKE BIDS ON A PORTABLE DEFIBRILLATOR FOR THE H & S EMERGENCY MEDICAL SERVICE.
- DISCUSSION OF CHANGING THE NAME OF D. AVENUE TO R-B MARTIN AVENUE.
- CONSIDERATION OF MONTHLY FIRE, AMBULANCE,

#### PUBLIC NOTICE

General Telephone Company of the Southwest, in accordance with the Rules of the Public Utility Commission of Texas, hereby gives notice that a Private Coin Service Tariff has been filed with the Public Utility Commission of Texas.

Under the proposed tariff, Private Coin Service would be offered for use with a customer-provided, instrument-implemented coin telephone at the request of the customer. The new service is scheduled to become effective on November 16, 1985, or upon approval by the Public Utility Commission of Texas.

The matter has been assigned to Docket No. 6309.

Persons who wish to intervene or otherwise participate in these proceedings should notify the Commission as soon as possible. A request to intervene, participate, or for further information, should be mailed to the Public Utility Commission of Texas, 7800 Shoal Creek Boulevard, Suite 400N, Austin, Texas 78757.

Further information may also be obtained by calling the Public Utility Commission Consumer Affairs Division at (512) 458-0223 or (512) 458-0227, or (512) 458-0221 teletypewriter for the deaf.

General Telephone



11 a.m. - 6 p.m. at Leatherman Park in Perryton, with a street dance that evening in the 900 block of Ash Street.

Entertainment scheduled throughout the day includes well-known author John Erickson, spinning one of his "Hank the Cowdogs" tales, break dancers from Perdue Recording in Amarillo, magician Richard Spears, fiddler Jack Bailey and guitarist Frankie McWhorter, along with square dancers, rock bands, vocalists and twirlers.

Over 20 booths from civic and business organizations will have all types of food for sale, everything from steak-on-a-stick to bunelos to homemade ice cream. Each booth will offer a different kind of food, enough choices to please every member of the family.

Game booths, over 20 of them, will be manned by local civic organizations and businesses. The booths range from a mechanical bull ride to dunking booths, ring tosses and an obstacle course. The Fun Day committee will also sponsor contests such as a three-legged race and egg toss, with Fun Day certificates presented to the winners. The certificates will be good at any booth during Fun Day.

A highlight of the day for the younger crowd will be a demonstration by a professional foot bag player. He will also lead the group in games, and hand out information sheets.

The street dance will feature Chuck Carrico and the Rhythm Riders from Darrouzett. The dance begins at 8 p.m. and lasts until midnight. Families are welcome to attend.

Leatherman Park is located right off Highway 15 and South Jefferson



Pictured are George R. "Bob" Scott, Grand Master of the State of Texas and his wife Rochell; H.M. Frazier, Secretary of the Gruver Lodge, and his wife "Birdie"; and John R. Collard, Jr., Past Grand Master of Texas, and his wife Marjorie.

Automotive Machine Work • Crankshaft Grinding • Align Boring  
Cylinder Boring • Valve Jobs • Surfacing • Rod Resizing  
• Pin Fitting

## PAUL'S MACHINE

806/659-5011 or 659-3003 (home)

402 HANCOCK • P.O. BOX 682 • SPEARMAN, TEXAS 79081

Career Sales Opportunity  
with FARM BUREAU Insurance  
Companies of TEXAS

QUALITY CLIENTELE

To Discuss This Opportunity

Call MELVIN BRADLEY at

659-3133

## Perryton Fun Day July 27

For a fun-filled day of excitement and entertainment, join Perryton residents for Fun Day '85 on Saturday, July 27. The event, sponsored by the Ochiltree County Chamber of Commerce, is set for

## PEOPLES SEAFOOD

will be at the Taylor Petroleum Station

501 W. Kenneth, Spearman, Thursday,

July 18 from 11 a.m. - 6 p.m.

Here's an investment idea for those who pay too much income tax.

Tax-advantaged investments could help you earn capital gains and tax-sheltered income. Not to mention how much less you'll be paying to Uncle Sam due to write-offs. And tax-advantaged investments can be relatively safe. Call me today for details.

Brian Diedrich  
P.O. Box 1001  
Seven Southwest 3rd  
Perryton, Texas 79070

Bus.: [806]435p7173 Res.: [806]435-7073



Edward D. Jones & Co.

Member New York Stock Exchange Member Securities Investor Protection Corporation

FREE! You are invited to

An Alfred  
Basic Piano Library  
Workshop

Tuesday, July 23, 1985 9:30 a.m.

Clinician Amanda Vick Lethco

Brier & Hale Music

424 N. Kansas

Liberal, KS. 67901

For more information contact

Alisa Henderson (316) 624-8421

### REPORT OF CONDITION

Consolidating domestic and foreign subsidiaries of the

First National Bank of Spearman  
Name of Bank of Spearman, Tex.  
In the State of Texas, at the close of business on June 30, 1985  
published in response to call made by Comptroller of the Currency, under title 12, United States Code, Section 161.  
Charter Number 18609 Comptroller of the Currency Dallas District

#### Statement of Resources and Liabilities

		Thousands of dollars
ASSETS	Cash and balances due from depository institutions	761
	Noninterest-bearing balances and currency and coin	4,600
	Interest-bearing balances	559
	Securities	
	Federal funds sold and securities purchased under agreements to resell in domestic offices of the bank and of its Edge and Agreement subsidiaries, and in IBFs	1,560
	Loans and lease financing receivables	
	Loans and leases, net of unearned income	1,837
	LESS: Allowance for loan and lease losses	006
	LESS: Allocated transfer risk reserve	NONE
	Loans and leases, net of unearned income, allowance, and reserve	1,831
Assets held in trading accounts	NONE	
Premises and fixed assets (including capitalized leases)	156	
Other real estate owned	NONE	
Investments in unconsolidated subsidiaries and associated companies	NONE	
Customers' liability to this bank on acceptances outstanding	NONE	
Intangible assets	NONE	
Other assets	045	
Total assets	9,540	

		Thousands of dollars
LIABILITIES	Deposits:	7,665
	In domestic offices:	
	Noninterest-bearing	1,775
	Interest-bearing	5,890
	In foreign offices, Edge and Agreement subsidiaries, and IBFs	NONE
	Noninterest-bearing	NONE
	Interest-bearing	NONE
	Federal funds purchased and securities sold under agreements to repurchase in domestic offices of the bank and of its Edge and Agreement subsidiaries, and in IBFs	NONE
	Demand notes issued to the U.S. Treasury	NONE
	Other borrowed money	NONE
Mortgage indebtedness and obligations under capitalized leases	NONE	
Bank's liability on acceptances executed and outstanding	NONE	
Notes and debentures subordinated to deposits	NONE	
Other liabilities	014	
Total liabilities	7,679	
Limited-life preferred stock	NONE	

		Thousands of dollars
EQUITY CAPITAL	Perpetual preferred stock	NONE
	Common stock	1,000
	Surplus	999
	Undivided profits and capital reserves	(138)
	Cumulative foreign currency translation adjustments	NONE
Total equity capital	1,861	
Total liabilities, limited-life preferred stock, and equity capital	9,540	

We, the undersigned directors, attest to the correctness of the statement of resources and liabilities. We declare that it has been examined by us, and to the best of our knowledge and belief has been prepared in accordance with the instructions and is true and correct.

Directors

Feima B. Evans  
Vice President & Cashier

of the above-named bank do hereby declare that this Report of Condition is true and correct to the best of my knowledge and belief.

July 15, 1985

# Sales tax up in county

AUSTIN, Tex.—State Comptroller Bob Bullock Thursday sent checks totaling \$56.8 million in local sales tax payments to the 1,003 cities that levy the one-percent city tax.

July checks represent taxes collected on sales made in May and reported to the Comptroller by June 20.

City sales and use tax allocation summary thru period ending July 3, 1985.

Hansford County was all smiles this week when State Comptroller, Bob Bullock, sent the one percent sales tax checks.

Spearman is up 28.93% and Gruver is up 25.53%.

In Gruver - net payment this period \$2,582.45, comparable payment prior year - \$1,810.42, 1985 payments to date - \$22,591.60, 1984 payments to date - \$20,283.07 and % change (to date) - 11.38%.

In Spearman - net payment this

period - \$14,380.81, comparable payment prior year \$9,967.41, 1985 payments to date - \$108,806.27, 1984 payments to date - \$84,389.75 and % change (to date) 28.93%.

The total for the county - net payments this period \$16,963.26, comparable payment prior year - \$11,777.83, 1985 payments to date \$131,397.87, 1984 payments to date - \$104,672.82 and % change (to date) - 25.53%.

# County gets job training funds

Governor Mark White announced today the allocation of \$103,949,667 to Texas' 34 local Service Delivery Areas for job training programs under the Job Training Partnership Act (JTPA).

The Texas Department of Community Affairs (TDCA) will contract with these local job training programs to prepare economically disadvantaged Texans for jobs in the private sector. Of the total amount, \$77,178,824 in Title IIA funds will be allocated to provide job training and other services to

teenagers and adults. The remainder, \$26,770,843 in Title IIB monies, will be designated specifically for summer youth employment programs.

"The Job Training Partnership Act is a valuable mechanism that brings the public and private sectors together to train Texans for productive employment and economic self-sufficiency," Governor White said.

Under JTPA, local elected officials work in partnership with private industry councils composed

of business and community representatives to design and implement job training programs that are tailored to meet the needs of area residents.

A listing of TDCA's funding allocations is attached. For more information, call Les Reedy at the Department of Community Affairs at 512-443-4100, ext. 333.

The Funding Allocations by service delivery area in the Panhandle. PY85 Funding: IIA-\$1,253,789 - IIB-\$587,342 in Hansford.

## Athletes travel to state meet



The 400 Meter Relay team, Midget Division are [l to r]: Brandon Rex, Brian Beck, Chad

Riggins, and Darian Hawkins. They are coached by Rick Smith.

Even though the city's summer track program has ended, there are several Athletes who will be traveling to state track meets.

Heather Murrell qualified for the AAU State Track Meet in Corpus Christi in three events, 100 meter hurdles, triple jump, and the high jump. Other AAU qualifiers were April Graham and Sunshine Smith for the discus and the 400 meter relay team whose members are Chad Riggins, Darren Hawkins, Brandon

Rex, and Brian Beck.

Heather Murrell also qualified for the TAAF State Track Meet in Ft. Worth in the 100 meter hurdles with a first place and a time of 15.3. At the Lubbock regional meet, she jumped 4'10" in the high jump for an alternate position.

April Graham received a first place in the discus qualifying her for the TAAF State Track Meet. Sunshine Smith placed fourth in the discus at the Lubbock meet.



April Graham



Sunshine Smith



Heather Murrell

Spray with a fine mist potted plants placed in the yard for the summer every day. Be sure the hose nozzle is set on a fine spray.

The Station Master's House Museum  
Box Supper & Cake Walk

Delano Realty  
COUNTRY LIVING  
2 N and 2 W of Gruver  
Close to town  
Beautiful 3 bedroom, 2 1/2 bath, with family room with fire place, large basement and a fenced yard.  
Steel working pens with barn and a 40x80 Behlen grain storage building. Large water storage tank with good submersible well.  
All this and approximately 11 acres of land.  
Contact Bob Ferguson  
Gruver, Texas  
Home 806-733-2288  
Office 806-733-5000

### Dr. Sheldon E. Baum, D. O.,

Announces the Opening of His Practice at  
**Golden Plains  
Diagnostic & Surgical Clinic**  
SPECIALIZING IN  
Diseases of Women  
Obstetrics - Gynecology  
Infertility & Female Surgery  
**FREE PREGNANCY TESTING**

503 W. FIRST SUITE A FOR APPOINTMENT Borger Call 274-7253

#### NOTICE OF INTENT TO IMPLEMENT RATES

General Telephone Company of the Southwest in accordance with the Public Utility Regulatory Act and the Rules of the Public Utility Commission of Texas gives notice of its intent to implement new exchange access rates for the provision of shared tenant and tenant resale services.

These proposed rates are applicable to customers of General Telephone Company of the Southwest, excluding hotel/motel customers, who provide local exchange telephone service of General Telephone Company of the Southwest to their tenants or patrons on a resale or shared use basis. This resale or sharing arrangement is normally provided utilizing a customer-provided PARX or other similar stored control switch capable of common control processing or other features commonly associated with a PARX "Smart" switch.

These proposed rates are designed to recover costs on a usage basis for local exchange telephone service access and are identical to General Telephone's "Optional Measured Service" rates. The monthly access rate will be \$28.95 per trunk line and the usage rates are as follows:

Over	Up To and Including	Band	Set Up	Full Rate Period Each Minute
0	7 miles	A	\$ .025	\$ .015
7	14 miles	B	.035	.021
14	21 miles	C	.050	.030
21	28 miles	D	.070	.042
28		E	.090	.054

As this is a new service offering, we are unable to determine the number of customers who may be affected. Currently, there are no known prospective customers. Until any customer utilizes this new offering, there will be no effect on the revenues of the telephone company, and in any event, the telephone company does not expect revenues to be affected by more than 2 1/2 percent. These proposed rates, where applicable, will provide tariffed local exchange access to customers who then will provide shared or resale services to tenants.

These proposed rates have been suspended by the Public Utility Commission of Texas and will become effective as proposed or modified by order of the Commission on a date to be determined by the commission.

The proposed rate schedule is on file with the Commission for public inspection and is also available at any business office of General Telephone Company of the Southwest. Persons who wish to intervene or otherwise participate in these proceedings should notify the commission as soon as possible. A request to intervene, participate, or for further information should be mailed to the Public Utility Commission of Texas, 7800 Shoal Creek Boulevard, Suite 400N Austin, Texas 78757. Further information may also be obtained by calling the Public Utility Commission Consumers Affairs Division at (512)458-0223 or (512)458-0227, or (512)458-0221 teletypewriter for the deaf.

General Telephone

# CARQUEST®

## AUTO PARTS STORES

# Summer Sale

**PV Heavy Duty Shock**  
Rugged 1/2" dia. piston rod, 1 1/16" bore dia. for a smoother, more stable ride under a variety of road conditions. Made by Monroe Auto Equipment Co.

**7.95** ea.

**CARQUEST Motor Oil**  
Quality that meets or exceeds all mfrs. specs. 10W40 or HD30.

Limit 12 quarts.

**69¢** qt.

**BRAVO™ Filters**  
Made by Purolator. Featuring a quality line of oil and air filters to fit most foreign & domestic cars.

Air Filters **1.99** ea. Limit 2

Oil Filters **1.69** ea. Limit 2

**DuPont Radiator Fast Flush**  
Helps prevent overheating. Harmless to metal or rubber cooling system parts. #2212N

**99¢**

**PV Thermostats**  
Quality at a CARQUEST price. Most applications. #30206, #30208, #30209, #30236, #30238, #30239

**1.49**

**Roberk Truck and Van Mirror**  
Heavy duty, chrome. Mounts on left or right. #760

**14.95**

**Gila Window Film**  
Helps keep the inside of your car cool during the hot summer months. Smoke #NRO56 Bronze #NRO57

**3.97**

**Acar 6" 12 Volt Oscillating Fan**  
12 volt fan for cool driving comfort. #RV270 Limited Quantities

**7.49**

**Perfect Circle Water Pump**  
New. Not remanufactured. For cars & light trucks only.

**5.00** OFF Regular Low Price

**I CAN HELP**

Got A Parts Problem? Ask a Qualified Counterman. Only CARQUEST has them.

**Coast-to-Coast CARQUEST Guarantee™**  
New CARQUEST Auto Parts Stores all across the United States will promptly replace any part bought at a CARQUEST store under the manufacturer's warranty. Another convenient service from CARQUEST... to make life a little bit easier.

Good at all participating CARQUEST Auto Parts Stores thru July 21, 1985.

**Gruver Farm Supply**

515 Main Gruver, Texas 733-2427

---

**Lone Star Service Center**

Rt. 3 Gruver, Texas 733-5263

**CARQUEST**

the Right Place to buy auto parts.  
Right Parts • Right Price • Right Advice.

## Facing West-Blodgett Home

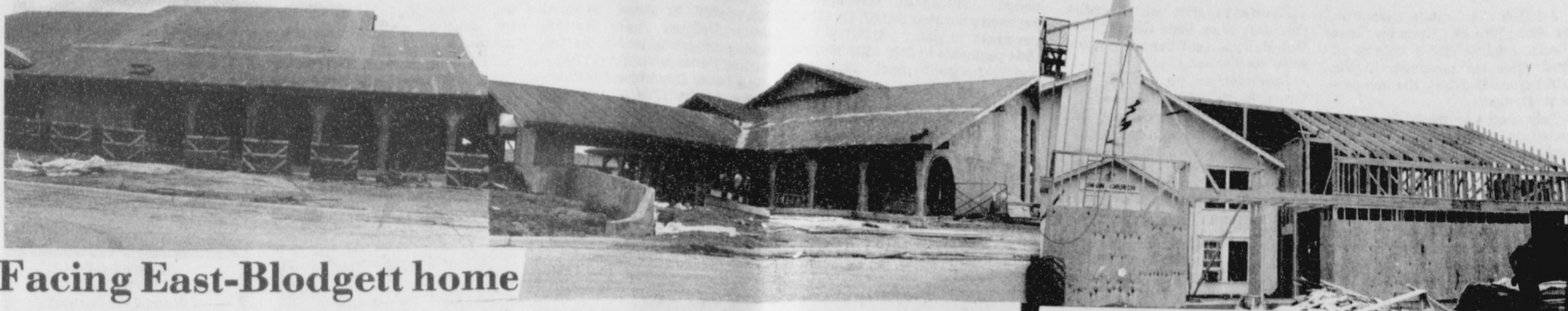

Facing East-Blodgett home

Union Church-Facing West

# Building boom in Spearman

BUILDING PERMITS  
TOTALS AS OF JULY 1, 1985

(RESIDENCE)  
NEW CONSTRUCTIONS

ADDRESS	SQUARE FEET	ESTIMATED COST OF CONSTRUCTION
700 Collier	2000 Sq.ft.	\$50,000
118 S. James	1550 Sq.ft.	\$38,000
14 S. James	1550 Sq.ft.	\$38,000
27 Golden Circle	3180 Sq.ft.	\$120,000
228 N. Hoskins	720 Sq.ft.	\$5,000
620 Evans	2730 Sq.ft.	\$64,000
716 Wilbanks	2032 Sq.ft.	\$63,000
26 Golden Circle	2660 Sq.ft.	\$87,000
12 S. James	1550 Sq.ft.	\$38,000
10 S. James	1550 Sq.ft.	\$38,000
711 Wilbanks	2112 Sq.ft.	\$45,000

Total of Estimated Cost of Construction \$586,000

NEW BUSINESSES

ADDRESS	SQUARE FEET	ESTIMATED COST OF CONSTRUCTION
Unit 2, Airport	3750 Sq.ft.	\$65,200
Hwy 207 S.	3888 Sq.ft.	\$17,600
North James	1810 Sq.ft.	\$60,000

Total of Estimated Cost of Construction \$142,800

ADDITIONS

ADDRESS	SQUARE FEET	ESTIMATED COST OF CONSTRUCTION
1102 S. Archer	2520 Sq.ft.	\$18,309
722 E. 2nd St.	240 Sq.ft.	\$3,000
1006 Barkley	264 Sq.ft.	\$15,000
521 S. Roland	660 Sq.ft.	\$3,500
222 S. Hazelwood	960 Sq.ft.	\$4,000
Airport Road	1800 Sq.ft.	\$5,200
18 N. James	336 Sq.ft.	\$1,500
1120 Linn	440 Sq.ft.	\$7,000
221 S. Bernice	234 Sq.ft.	\$20,000
202 S. Hazelwood	576 Sq.ft.	\$4,000
210 E. 3rd	420 Sq.ft.	\$2,000

Total of Estimated Cost of Construction \$ 83,509

GRAND TOTAL OF ESTIMATED COST OF CONSTRUCTION \$812,309

A building boom continues in Spearman. Two of the largest buildings are the Blodgett home with a permit of \$400,000 for 7600 sq. ft. issued in 1984 and the Union Church 3551 sq. ft. at a cost estimate of \$214,000 which was also issued in 1984.

Counting these permits and the permits for 1985 thru July 1, well over \$1,000,000 is being spent in Spearman constructing new homes, new businesses, and additions.

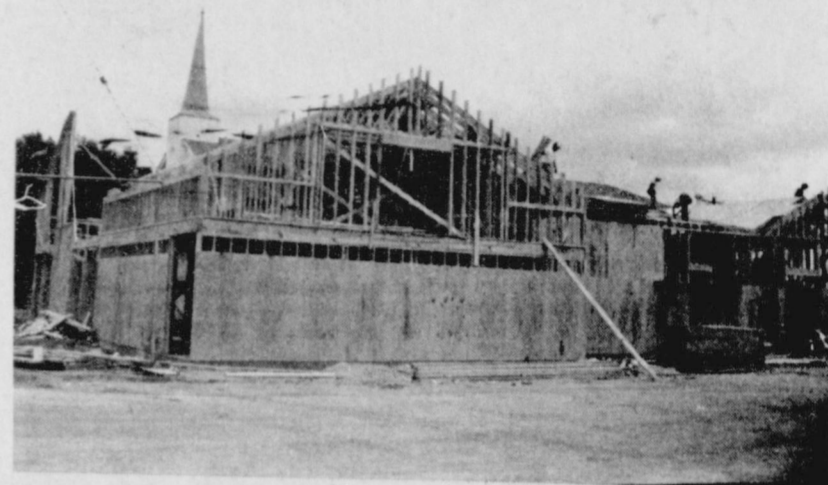

Union Church-Facing South

Shop your Spearman TG&Y

## Bulls' Country

## closing-out

## sale

22 S. Archer

Spearman, Texas

## Wholesale prices

Friday and Saturday, July 19 & 20--

9 a.m. to 5 p.m.

Sunday, July 21--

1 p.m. to 5 p.m.

**Definition**  
Heavy Drinking: Drinking between drinks.  
-Gosport, Pensacola, Fla.

**Four A Year**  
A vacation is what you take when you can't take what you've been taking any longer.  
-Record, Columbia, S.C.

Let the child's first lesson be obedience, and the second will be what thou wilt.  
-Benjamin Franklin.

Obedience is much more seen in little things than in great.  
-Thomas Fuller.



Woe to him that claims obedience when it is not due; woe to him that refuses when it is!  
-Thomas Carlyle



## New W.M.

Mansel and Charlene Bryan and Patti and Mike Schnell attended the installation of Masonic officers Saturday night. Mansel was instal-

led as Worshipful Master. Mike is the immediate past Worshipful Master.