



WEATHER

November 28	44	25
November 29	65	26
November 30	58	23
December 1	53	21

BAILEY COUNTY JOURNAL

'The Community Of Opportunity-Where Water Makes the Difference'

Vol. 22, Number 49

12 Pages Today

Published Every Sunday at Muleshoe, Bailey County, Texas 79347

Sunday, December 2, 1984

Around Muleshoe

Muleshoe City Police Chief Les Irvin told the Journal Thursday afternoon that The Fair Store had been burglarized during the preceding night.

Chief Irvin said the burglar or burglars had apparently bypassed money, clothing and rifles in the store, taking only the entire selection of handguns featured in the store.

Investigation into the burglary was continuing at presstime.

Be sure to read the Thursday, December 6, edition of the Muleshoe Journal for a current update on the hospital situation in Muleshoe.

A Farm Bureau Board of Director meeting is scheduled for Thursday, December 6, at 7 p.m. in the director's meeting room at the Farm Bureau offices.

Brenda Robertson said Richland Hills Baptist Church WMA will conduct a bake sale Wednesday, December 5, beginning at 9 a.m. at Pay and Save Food Store.

For special orders, call by Monday to place your order at 272-3646 or 272-3229.

The GED test will be given in Muleshoe on December 7 and 8 in the Muleshoe High School. Testing will begin at 5:30 p.m. on Friday, December 7 and at 8:30 a.m. on Saturday, December 8.

The test consists of five sections and individuals may Con't On Page 6, Col. 1

Varsity Girls Record 1-1

After Plains

Tuesday night, at Plains, the Muleshoe Mulettes varsity team breezed by the Plains team by a score of 46-28.

Leading scorer for the Mulettes was Debbie Isaac with 19 points. Michelle Logsdon had 10 points; Julie Sanders, five; Lenore Daniel and Kristi Campbell, each four points and Zonell Gatewood and Christy Landers each had two points.

Playing outstanding defense for the Mulettes were Polly Harrison and Camille Buchenau. The win Tuesday night brought the girls' record to 1-1 for the season.

The preceding night, the Muleshoe Freshman girls fell to Dimmitt by 35-47.

High scorer for the game was Kim Glover with 17 points; in second with points was Michelle Stevenson, who had eight points, and 15 rebounds.

The freshman girls are 1-1 for the season at this time.



CHECKING IT OUT--Thursie Reid was captured on film at the Arts and Crafts Bazaar at the Civic Center Friday at noon. Mrs. Reid was looking over paintings of various sizes, just a mini-portion of the large selection at the annual bazaar.

SPS Signs Contract To Cut Coal Costs

Southwestern Public Service Company (SPS) has negotiated contracts that will significantly reduce costs customers eventually pay for hauling coal by rail from Wyoming mines for use at SPS power plants, such as Tolk Station near Muleshoe, company officials announced Wednesday.

New contracts with the Burlington Northern Railroad and the Santa Fe Railway will lower costs of delivering coal to the power plants by about \$27 million in 1985, said Bert Ballengee, SPS president and

School Board

Special Meet

Held Thursday

Members of the board of trustees of the Muleshoe Independent School District Board of Trustees met Thursday evening in special session to discuss a couple of items.

Included in the discussions were athletic policies and extra-curricular activity policies.

No action was to be taken on either item, and they will be discussed further, with possible action taken during the next board meeting next week.

chief operating officer.

"The new contracts will save our customers an estimated \$790 million through the year 2002," Ballengee said.

Ballengee cautioned, "These contracts provide an excellent overall savings for customers. We're lowering fuel costs by some five to six percent. But, of course, purchasing fuel on the open market—as we must do—remains expensive for us, as it is for everyone."

The new contracts will hold down the average SPS residential customer's electricity bill by about \$1.07 per month, Ballengee said. The reduction could begin as early as 1985.

The average SPS residential customer uses 635 kilowatt hours of electricity monthly. The average monthly bill for a residential customer in Texas is \$45.91, plus sales tax. An average New Mexico customer pays \$46.94, plus tax. The average customer in Oklahoma pays \$49.27 per month, plus tax. In Kansas, the price of 635 kwh is \$51.33, plus sales tax.

Southwestern's last general rate change, an increase, was in mid-1982.

The importance of the new contracts will become more apparent in the future, Ballengee said, when SPS

Scout Award

Dinner Slated

At Littlefield

It was announced during the meeting of Cub Scout Pack No. 620 Tuesday evening, that the pack would be marching in the annual Christmas parade on Saturday.

Included in the parade was the Salvation Army Disaster Canteen van from Amarillo, and they were accepting toys for the needy children at that time.

Den No. Nine, reminded everyone of the meaning of Thanksgiving. "On Thanksgiving Day, people have a feast and thank God for their blessings," (Eric McElroy).

Charlena Lindt and Mary Ann Ramirez were recognized as new den leaders.

On December 3 the district committee meeting will be at 7:30 p.m. in Muleshoe at K-Bob's and on December 8 the George White District Banquet will be at 6 p.m. at the community center in Littlefield. The banquet is a bring-your-own covered dish and is held to recognize outstanding Scouts and leaders.

Earning badges were Freddy Perez, Bobcat; Neal Watson and Charles Villarreal, one silver Wolf arrowpoint each; Justin

Con't Page 6, Col. 3

Fire, Rescue Evacuation Drill Held Wednesday

Varsity Mules Hold 3-0 '84 Record

Friday night, the Muleshoe Mules widened their 1984 basketball season record to 3-0 with a 67-53 rousing of the Abernathy Antelopes.

Leading scorer for the Mules was Rob Donaldson with 24 points. Second and third place scorers were Mark Moton with 16 and Andy Copley with 10 points.

For Abernathy, leading the scoring was Sam Galloway with 23, while Chester Cooper had 12 points.

Leading rebounder for the Mules was Rob Donaldson with 16, while John Isaac had 12 rebounds.

The Mules hit 50 percent from the free throw line and 68 percent from the field. Abernathy hit 24 percent from the field.

The same evening, the Mules JV team fell to Abernathy JV by a score of 24-42.

Plains fell to the Muleshoe Mules Tuesday night as the Mule varsity team rolled over the Plains roundballers, 65-51.

Leading scoring for the Mules was Rob Donaldson, with 17 points; followed by Mark Moton's 16 and 15 for Andy Copley.

An amazing 48 rebounds marked the Mules' victory, as Rob had 22 rebounds and John Isaac had 17 rebounds in the game.

The Mules shot 47 percent from the field, making 27 of 58 attempts. They also hit on 11 of 20 free throw tries. Plains shot 37 percent from the field.

At this time, the Mules are 2-0 for the season.

Muleshoe's JV team fell to plains 42-54 during the evening at Plains.

Savings Bonds

Given Winners

After Contest

According to Muleshoe School Superintendent H. John Fuller, savings bonds have been distributed to the winners of the recent contest on "Why You Should Vote." He commented, "We are very proud of these students and all those who participated in the contest."

Receiving savings bonds were Jason Buckner, Mary Payne and Jason Fuller, for their outstanding posters.

Dustin Elliott, Angie Krey, Kristie Pena, Becky Mardis, Betsy Lunsford, Stacy Smith, Sherri Stovall, Caryn Durben, Lisa Noble, John Isaac, and Kristen Chitwood won savings bonds for their equally outstanding essays.

Bonds were donated by the following: Barbara McCamish, Bobo Insurance Agency, Summitt Savings, Bailey County Electric Cooperative, Muleshoe Journal, Western '66' Company, Valley Grain and Farmers Co-op Elevators.

Also, Mrs. Horace Blackburn, Leo's Blacksmith Shop, Muleshoe State Bank, Muleshoe Co-op Gin, Poyner's White Stores, First National Bank and Bailey County officials.

The following letter was mailed to the student with their bond:

Dear Student:
Congratulations on being named a winner in our contest on "Why You Should Vote." You did a great job on your essay or poster. Enclosed is your savings bond for \$50.00. This bond was donated by one of the following businesses.

We are very proud of you and your achievements.

Sincerely,
Mrs. Johanna Dean and
H. John Fuller
Superintendent of Schools.

An interesting and most unusual 'drill' was conducted in Muleshoe on Wednesday night. Unknown to most people, Gerry Pierce of Combination Motors moved a car onto a lot behind the Muleshoe Fire Department truck storage building around dark.

Firemen, EMT's and a few local police officers gathered at the location shortly after 7:30 p.m. and the drill was underway.

Acting as though they were working on a real emergency, but at a slower pace, as it was a teaching session, the emergency crew went through the entire drill for evacuation and rescue of the two real victims who were inside the car which was turned on its side.

Gasoline (real gasoline) had leaked out of the tank, and the gasoline had to be removed, or covered, to provide safety for the firemen and EMT's who were conducting the drill.

A fire truck was moved into

position near the car, the rescue van was moved into position, the firemen and EMT's donned their working clothes, which included helmets, boots, coats, coveralls, gloves and other protective devices and went to work.

As some of the newer firemen are being trained in the use of the "Jaws of Life" the drill was conducted precisely and slowly. Trained Jaws of Life operators opened the car door slowly and carefully, going over each step of the rescue operation as they worked. Other firemen were securing the area, and making sure that the working area for all emergency personnel was as safe as possible.

Once the door was opened, and the windshield removed, EMT's went to work with lifesaving measures before the victims were removed from the car. Once the victims were secured and removed, the EMT's then administered other lifesaving measures to the victims.

Instructors J.O. Parker and Larry Rasco reviewed the exercise after it was all over, making corrections and commending everyone's participation and attendance.

It was suggested that such training be conducted on a regular basis involving fire department personnel, EMT personnel and law enforcement officers.

Fire Department Reporter Wayne Peterson told the Journal Friday that over the last 60 days, the Jaws of Life has been called upon six times.

"With updated training as we had Wednesday night, we think lives can be saved," said Peterson.

Con't Page 6, Col. 4

Dear Santa; I Want---

THAT! time of year has crept up on us again, and ready or not, we are full swing going into the Christmas season. Recently, most of what we see includes Christmas decorations and gifts, on the air, there is mostly Christmas music, and street decorations have been going up. And-to top all that off, the first 'Dear Santa' letter has arrived in The Journal offices.

Elementary schools in Muleshoe, Lazbuddie and Three Way have been contacted by The Journal get their letters to Santa into the Journal offices to be printed in the paper.

This is the first 'Dear Santa' letter received for 1984: Dear Santa

I want a pair of blue snow boots, a Cabbage Patch Kid with a pacifier, and a mother monkey.

P.S. I will leave you some apples.

Love, Katy Jones

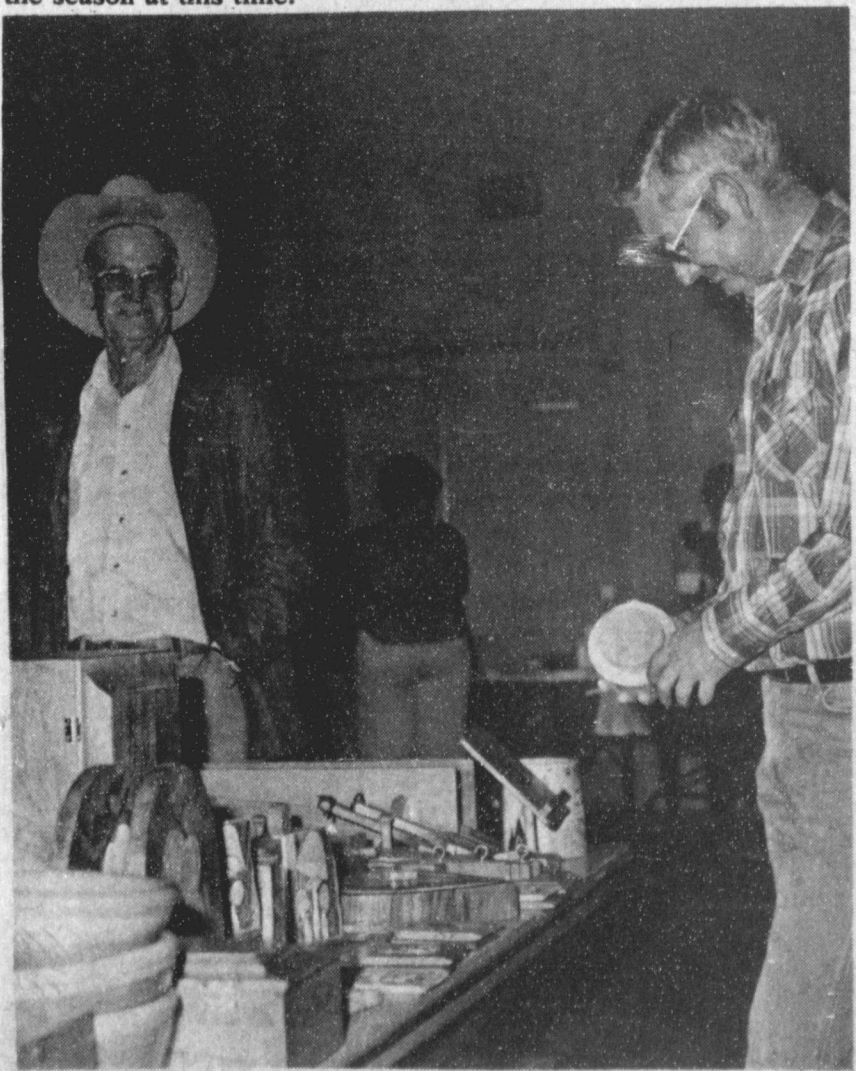

LOOKING AT WOOD ITEMS--Jack Bates, left, Justice of the Peace, looks on as DPS L&W Trooper Lyndon Huckaby checks over hand made wood items at the annual Arts and Craft Bazaar at the Civic Center Friday. People crowded the show as soon as the doors were opened to the public.



LOOKS REAL DOESN'T IT--EMTs Deanna Rasco, left, Misti Prater, center, and Larry Rasco, administer first aid and emergency life saving measures to one of the victims during a 'drill' Wednesday night.

Sudan News

By Evelyn Ritchie

Mr. and Mrs. Brad Bell of Seminole visited during the weekend with her parents, Mr. and Mrs. Jerry Ray, her sister,

Mr. and Mrs. Roby Lynn and girls and also her grandmother, Mrs. Mabel Reed. The Bells have recently moved to Seminole from Ranger. Tanya will be teaching in the Seminole schools and Brad is engaged in farming.

T.W. Fife has returned home from the hospital and is reported doing well.

Allen Beale is a patient in room 303 in the St. Mary's Hospital in Lubbock.

Casie Legg was to undergo ear surgery on Tuesday at the St. Mary's Hospital in Lubbock but was expected to be released later in the day.

On Monday, Nov. 19, the two & three year olds of the Church of Christ had a Thanksgiving party in the home of Mike and Denece McDonald with Rita Conley and Mr. and Mrs. Jim Ingle sponsoring it. The four & five year olds had their party in the fellowship hall with Mr. and Mrs. Alan Black and Mr. and Mrs. Randy Pierce as sponsors.

Weekend visitors in the home of Mr. and Mrs. Harold May were their daughters, Bernadette of Dallas and Mr. and Mrs. Randy Rogers also of Dallas. Also visiting were Mr. and Mrs. L.R. McFarland of Burleson. They were here also to attend the bridal shower honoring Mrs. Rogers, nee Mary May.

Mr. and Mrs. Dewayne Phillips, Christie and Michael were in Morton Friday night to attend the wedding of his niece, Robin McBee to Terry Webb when Christie was flower girl and Michael was ring bearer.

Annette Capers was honored Sunday on her first birthday with a family get together in the home of her mother, Mrs. Sherry Capers. Others attending the party were Rebecca, sister of the honoree and her grandparents, Mr. and Mrs. B.A. Beauchamp and Derwin.

Thanksgiving holiday guests in the home of Mr. and Mrs. Sammy Crowson and family were his mother, Mrs. Geneva Crowson and his brothers Danny of Lubbock, and Rev. Donnie Crowson of Colorado City; Also her parents, Mr. and Mrs. Wendel Whisenant of Brownfield. Their son Wade of Texas Tech also spent some of the holidays with them.

Thanksgiving holiday visitors with Mr. and Mrs. Bernard Wilson were their son, Mr. and Mrs. Jackie Wilson and family of Abilene.



OFF TO STATE--Kenneth Carr, Ag teacher accompanied four Sudan FFA boys to State Competition Saturday, Dec. 1 in Greenhand Farm Skill. Eddy Boyles, Michael Bartley, John Taylor and Clyde Conley, alternate, placed first in district and first in area competition qualifying them for state competition at Sam Houston State university in Huntsville. Also competing was Chapter Farmer Skill team consisting of Brent Kirkland, Dean Johnson and Charles Kessler. They placed first in District.

This is the time of the year when the busiest men find time to attend a game of football.

LATEST ARRIVALS



Zachary Lee Roberts

Airman and Mrs. Brian Roberts are the proud parents of a son born Monday, Nov. 19 at 9:58 a.m. in San Diego Naval Hospital.

The young man weighed seven pounds and ten ounces and was 21 inches long. He has been named Zachary Lee.

Grandparents are Mr. and Mrs. Arnold Archer of Muleshoe and Mr. and Mrs. Burley Roberts of Enoch.

Great grandparents are Mrs. Hazel Riddle of Muleshoe, Mrs. Bertha Roberts of Morton and Mr. and Mrs. Billie McDonald of Lubbock.

SMALL WONDER

Amana
COMPACT MICROWAVE OVEN

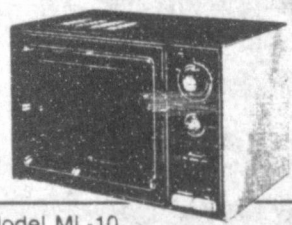

Model ML-10

\$199⁹⁵

Save space and cook fast and easy with this Amana microwave oven. Its compact size fits almost anywhere and you get many wonderful "big oven" features.

- 500 WATTS OF COOKING POWER cooks in just 1/2 the conventional time.
- DEFROST CONTROL thaws frozen food fast.
- EASY DIAL TIMER has adjustable speeds to 20 minutes.
- SEE-THROUGH DOOR AND INTERIOR LIGHT make it easy to see food as it cooks.
- REMOVABLE COOKING TRAY catches spills and boilovers.
- AMANA MICROWAVE OVEN COOKBOOK

Buy the Amana Compact Microwave Oven at:

Harvey Bass Appl.
122 S. 1st 272-3030

Bailey County Journal

Established March 31, 1963. Published by Mule Publishing Co., Inc. Every Sunday at 304 W. Second St., 449, Muleshoe, Texas, 79347. Second Class Postage paid at Muleshoe, Texas 79347.

MEMBER 1984
TEXAS PRESS ASSOCIATION

L.B. Hall, President
James Woods, Vice President
Celia Williams, News Editor
Evelyn Harris, Society Editor
Holk Millsap, Advertising Editor
Lillie Snow-Cryer, Classified Editor
Sammy Hall, Bookkeeper

SUBSCRIPTIONS:
Muleshoe Journal and Bailey County Journal
Bailey and surrounding counties \$12.95
Muleshoe Journal and Bailey County Journal
Elsewhere in Texas \$13.95
Muleshoe Journal and Bailey County Journal
Outside of Texas \$13.95
Yearly by Carrier \$11.50
Advertising rate card on application.

Musicians' Hideaway

303 Main

Clovis

769-1003

At Musicians' Hideaway we offer imagination and innovation - not imitation. We have this area's largest selection of new and used musical equipment including guitars, amplifiers, drums, keyboards and synthesizers, PA systems, microphones, and much more, including all kinds of accessories, by the top names in the music industry. We pride ourselves in our service, selection, and value, and for this season we have:

The Perfect Gift For That Special Musician:

The "Guitar Tune-Up Kit"



only **\$15⁹⁵**

Includes:

- ✓ A set of Fender Electric or Acoustic Guitar Strings (make it sound like new!)
- ✓ A 6-note Pitch Pipe (keep it tuned up!)
- ✓ Guitar Polish and Polish Cloth (Protect and Shine it up real pretty!)
- ✓ A string-winder (makes re-stringing faster and easier!)
- ✓ A dozen picks with a pick pouch (you won't lose those picks as often)

All This In A Convenient Package Worth Over \$24.00 But

Now Only \$15⁹⁵ at The Store That Gives You

"The Most For Your Music Dollar"

Musicians' Hideaway

Service, Repair, Rental & Lessons



**Tuesday
December 4**



Anthony's Allegiance Club Members

FAMILY SHOPPING NIGHT

7:00 PM until 10:00 PM

Tuesday, December 4

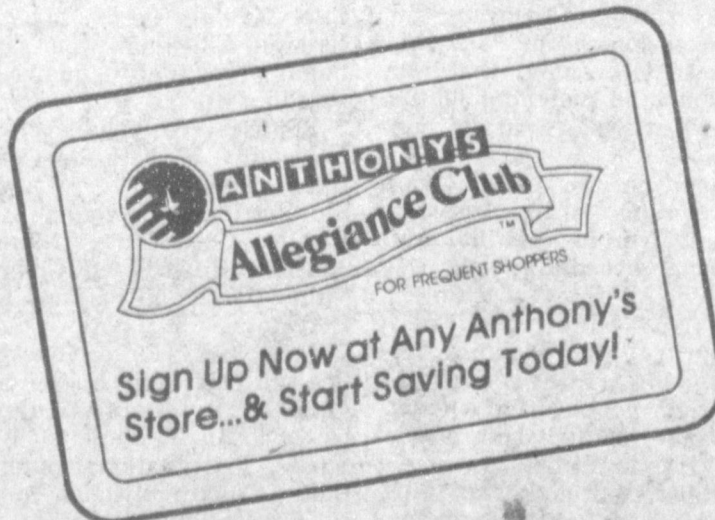

Sign Up Now at Any Anthony's Store... & Start Saving Today!

- ★ Free Gift Wrapping
- ★ Special Family Shopping Hours
- ★ Extra Savings for Allegiance Club Members
- ★ Preview our Holiday Gift Guide
- ★ We Accept

We will be closed from 6 PM to 7 PM to prepare for this special Family Shopping Night. Our doors re-open promptly at 7 PM. If you are an Anthony's Allegiance Club member, be sure to be here! Mark **Tuesday, December 4th** on your calendar. Bring the family. Finish your Christmas shopping early. These special hours are just for you! If you are not an Anthony's Allegiance Club member, come in to sign up...and start saving today!

New Store Hours

8:00 am
TO
8:00 pm

We're Just Around the Corner Serving You!

ANTHONY'S

321 South Main
Phone
272-3478

A&M
NEW STORE HOURS
7:30 A.M. till 7:30 P.M.
MONDAY
THROUGH SATURDAY

OPEN SUNDAY
1 to 5 PM
Until Christmas
For Your Shopping Convenience
Playmates young sirs
1015 W. 2nd - Portales
Grand & Main - Clovis



MRS. CODY CRITTENDEN
(nee Marleea Cox)

Miss Cox, Crittenden United In Marriage

Miss Marleea Cox and Cody Crittenden were united in marriage Friday, Nov. 9 at 7 p.m. in the chapel of the First United Methodist Church with the family of the bride and groom in attendance. Phil McClelland, pastor of the First United Methodist Church of Amherst, read the double ring vows.

Parents of the couple are Mr. and Mrs. Reagen Cox and Mr. and Mrs. Wayne Crittenden, all of Muleshoe.

The church was decorated with lilac candles and silk flowers.

Laura Leal played prelude music on the piano.

Debbie Norwood, soloist, sang "Evergreen" as Brandon Cox seated the bride's mother and grandmothers on the bride's side and Wayne Crittenden seated the groom's mother and grandmothers. Ms. Norwood was accompanied by John Norwood, on the guitar.

"The Wedding Song" was played while the parents of the couple lit tapers of the unity candle. During the singing of "The Lord's Prayer" the bride and groom lit the unity candle.

Given in marriage by her father, the bride wore her mother's wedding dress. It is made of antique satin with a bustle. The bodice featured an overlay of organza with heavy

lace. She wore a hat which was covered with organza and lace, made by her mother.

Something new was her hat. She carried a handkerchief made by her great great grandmother for something old. Something borrowed was her slip, belonging to Susan Wilson, sister of the groom. Garters, also made by her mother, were something blue. Ronnie and Sandra Schroeder gave the bride a six pence for her shoe.

Stephanie Cox, sister of the bride, served as maid of honor. She wore an ecru lace blouse and a tea length skirt. The skirt was made of lilac taffeta and was a drop waist style.

Wayne Crittenden, father of the groom, served as best man. Both, the groom and best man wore silver tuxedos and an ivory colored shirt.

Following the ceremony everyone was invited to Mr. and Mrs. Wayne Crittenden's home for the reception. Julie and Kathy Crittenden served punch and wedding cake.

D'Nae Wilson handed out bags of bird seed to all the guests.

CLASSIFIED SELLS!
Call 272-4536 Today

For Trip Tips
Phone 272-5130
or Toll Free
1-800-462-TRIP

Christmas Sale

10% off

Rob Roy
Boys Wear

Ladies
Jack Winter
Coordinates

Mens
Arrow Dress
Shirts

Ocean
Pacific
Junior Wear

Hurst Department Store 272-5640
110 MAIN

Bridal Shower Honors Mrs. Randy Rogers

A bridal shower honoring Mrs. Randy Rogers, nee Mary May, was held Saturday, Nov. 17 at the community room of the First National Bank in Sudan.

The serving table was covered with a light blue lace edged cloth and accented with a basket of blue and brown silk flowers.

A fudge plate, spiced tea and coffee were served from silver

and crystal appointments.

Special guests included the mothers of the couple, Mrs. Harold May of Sudan and Mrs. L.R. McFarland of Burleson sister of the honoree, Bernadette May of Dallas; Marilyn Carter of Littlefield, a cousin; and her aunt, Barbara May of Sudan. Other out of town guests included: Billy Farmer of Littlefield and J'Lee Turner and Brandi of Amarillo.

The hostesses gifts were a large laundry basket filled with miscellaneous items and the centerpiece from the serving table.

Hostesses for the occasion included: Mrs. Clyde Flowers, Mrs. Terry Swart, Mrs. Jimmy Ford, Mrs. Chris Pope, Mrs. Rick Humphreys, Mrs. Dyke Gaston and Mrs. Olin Nix.

**TOPS
CLUB**

Muleshoe TOPS Club chapter No. 34 met at 6:30 p.m. Thursday, Nov. 15 in the meeting room of Bailey County Electric.

Clara Lou Jones, leader, called the meeting to order. The TOPS pledge was recited and the fellowship song sung.

Laverne James, weight recorder called the roll with 11 members present. Evelene Harris, secretary, read the minutes of the previous meeting and they were approved.

Ruth Clements was named best loser for the week and Clara Lou Jones and Evelene Harris tied for first runner up.

Evelene Harris received a check for a hair set she had earned by losing weight for six consecutive weeks.

Jewell Peeler reported that side one is still ahead in the contest.

A card was signed for Lou Knowles, a former member, who was injured in a car accident recently.

The meeting was closed with the singing of the goodnight song.

Sudan Senior Citizens

On Saturday, five Sudan Senior Citizens went on the Senior Citizens bus to the annual Thanksgiving dinner held at the Needmore Community Center.

A turkey dinner was served and visiting was done by the group including Ila Ruth Gilreath, Earlene Kropp, Mr. and Mrs. Marvin Tollett and Jonelle Bandy.

On Sunday afternoon six of the members attended the Golden Melodies and Memories Symphony in Lubbock at the Civic Center Theatre.

Attending this were Ila Ruth Gilreath, Verdine Gann, Earlene Kropp, Esther Meeks, Seva Ray and Ouida Parrish.

ICARE

Muleshoe State Bank,
The Only Bank That Furnishes
You With Your Very Own
Personal "ICARE" Banker.

Come In And Visit With Us
About Our "ICARE" Program.

Back: Alice Burge & William Ed Jones
Front: Mary Moore & Cozette Blackwood

Muleshoe State Bank
Member F.D.I.C.

101 West American Blvd. 272-4561

WMU Weekly Meeting Held

WMU of the Trinity Baptist Church met Tuesday, Nov. 27 at the church for Bible study with five members present.

Those present included: Clara Coffman, Dora Barber, Pearl Dunlap, Maxine Carter and Winona Spears.

Ms. Carter led the group in prayer and the teaching was on "Partnership Principles."

The man who tries to work all day, and night, too, isn't always the fellow who gets the most work done.

SINGER CELEBRATION

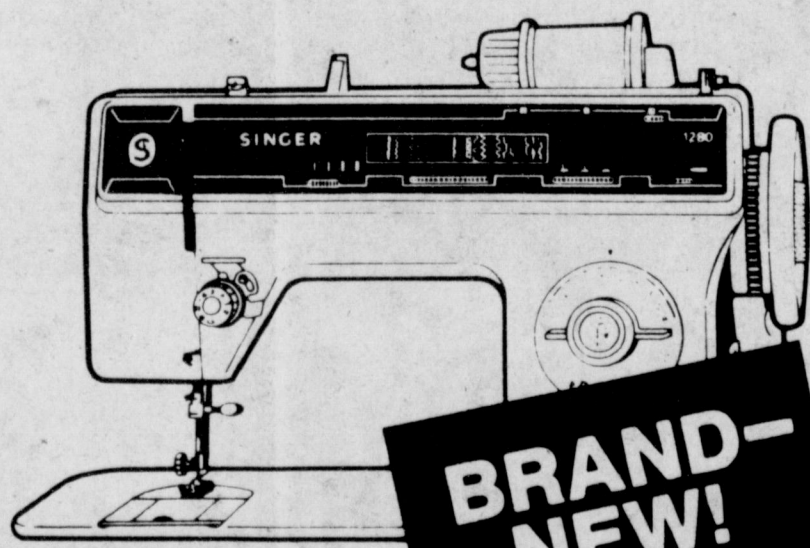

**Fashion Mate Deluxe
Machine Model 1280**
Select from 19 stitches.
Bobbin removes without
fuss. Built-in buttonholer.
Adjusts to various fabric
thicknesses.

REGULAR \$499⁹⁹
\$249⁹⁹



**The Debutante Machine
Model 6212**
5 popular stitches. Built-in
buttonholer. Easy threading.
Adjusts to various fabric
thicknesses.

REGULAR \$299⁹⁹
\$199⁹⁹

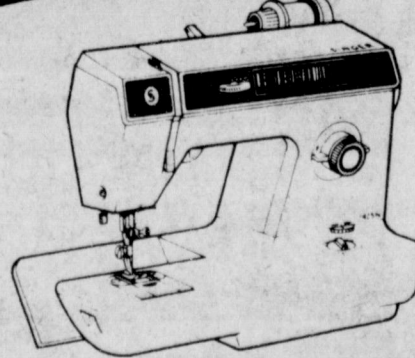

**Flip & Sew Machine
Model 1425**
25 stitches including speed
baste and adjustable maxi-
topstitch. Wind-in-place bobbin.
1-step buttonholer.

REGULAR \$849⁹⁹
\$449⁹⁹

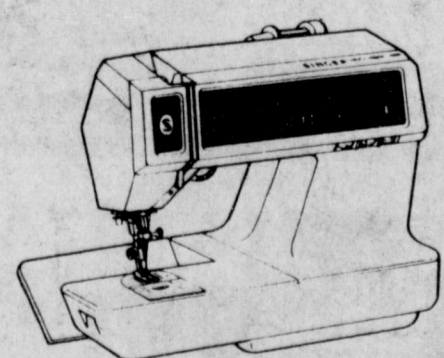

**Touch-Tronic 2010
Memory Machine**
29 stitches preprogrammed to
sew the optimum length and
width. 1-step buttonholer. Low
bobbin indicator.

REGULAR \$1399⁹⁹
\$799⁹⁹

SINGER
APPROVED DEALER

Expert repair service on all brands of sewing machines.
Free lesson with any machine purchased. We take trade-ins.

Harvey Bass Appliance

CHRISTMAS Shopping HQ.

All
Atari & Commodore
Computers
Prices Reduced For Christmas



Atari 2600 VCS 2 Only **\$49⁹⁵**
(Includes 2 Games)

ALL Televideo Business Computers
(IBM Compatible) **10% OFF**

All Atari & Commodore Games & Software

20% OFF



These prices include
word processor, spread
sheet, data base
management software

**Williams Bros. Office
Supply**

322 Main 272-3113

122 S. 1st.

Muleshoe

272-3030

The Creative Woman

By Sheryl Borden

Because of the tremendous response to the first special, "The Creative Woman" show will feature another hour-long live special on Saturday, December 8 from 2:00 until 3:00 pm on Channel 3. The special will be a part of the December Pledge Drive for the station. Guests will serve as co-hosts with Sheryl Borden, Producer/Host for "The Creative Woman".

Connie Moyers, Marketing Home Economist with Southwestern Public Service Company will share several easy and quick recipes for making holiday candies in the microwave oven.

Vickie Willis, also home economist with SPS in Rosewell will demonstrate edible Christmas ornaments made with melted chocolate. The ornaments can be used on packages, on the tree or just to eat.

Jo Beth Massey, a home economics student at Eastern New Mexico University will share some Christmas crafts she and her children enjoy making each holiday. These are all quick, easy and very inexpensive to make and especially fun for children.

Last minute gift ideas will be presented by Joy Best, Extension Home Economist in Portales. These will be ideas for men, women and children and will help make holiday time less hectic for everyone.

The final portion of the Christmas special will be a holiday fashion show presented by The Blue Room in Clovis. Janice Gardner, co-owner of the Blue Room will be a featured guest.

Viewers who call in to pledge or re-new their pledge to KENW-TV will be able to request a copy of either The Creative Woman or Creative Living booklets. This offer will only be available during the hour special.

The regular show for December 4 will feature three topics. (For this week only, the show will not be repeated on Saturday, December 8 because of the live special). Campsite cooking with Reynolds Wrap will be one topic and this will be presented by Cathy McCreery from Dallas. According to Ms. McCreery, aluminum foil is indispensable to the camper. It's not just a food wrap. It can be transformed into campsite essentials for cooking

and eating. Several years ago, Universal Foods introduced a special recipe using yeast to ferment fruit--thus creating a fruit sauce with a deliciously different vintage flavor. The recipe is called vintage fruit sauce and it's enjoying a come-back in popularity. Fran Smith is a home economist with Universal Foods and she will show some very tasty ways to serve the fruit sauce.

Color--the missing link in communication will be discussed by Sandy Parks, President and Founder of Color Charisma from Atlanta, Georgia.

On December 6 three additional topics will be presented on "The Creative Woman". (Because of Pledge Drive, the show will not be repeated on Sunday, December 9). For those occasions when you'd like to share a special culinary creation, Linda Behrends, home economist with the American Soybean Association will share some very special recipes and ideas that are fun to make and look special, too.

Grocery shopping can be a real challenge--not to mention an education. Guest Audrey Waldorf, home economist with the Roman Meal Co. will discuss shopping strategies. Ms. Waldorf is from Tacoma, Washington.

The first part of the show will be a demonstration on fabric painting by Glen Ray Klebold of Clovis.

"The Creative Woman" is produced and hosted by Sheryl Borden. The show airs on KENW-TV at 12 noon on Tuesday and Thursday, at 2:00 pm on Saturday and at 5:00 pm on Sunday (all times are Mountain Standard).

Viewers can request copies of printed materials offered on the shows by calling on KENW-TV's toll-free telephone lines. In New Mexico, the number is 1-800-432-2361; out-of-state: 1-800-545-2359 and Portales and Roosevelt County is 562-2112.



Beau Brummel, the English dandy and gambler, was well known for snoring in his sleep.



ENGAGEMENT ANNOUNCED--Elizabeth Wood, daughter of Dale and Dolores Wood of Monahans, will become the bride of Phil Donaldson of Mt. Sterling, Ky., son of Everett Donaldson of Mt. Sterling, Ky. and the late Ina Donaldson. Vows will be exchanged at 3 p.m. Saturday, Dec. 29 at the Third and Dwight Church of Christ in Monahans. Everett Donaldson, father of the prospective groom, will perform the ceremony. Miss Wood is a 1982, graduate of Monahans High School and is presently a Junior Agricultural Business student at Abilene Christian University. Donaldson is a 1981, graduate of Mt. Sterling, Ky. High School. He will be a December 1984, graduate of Abilene Christian University with a BS degree in Agriculture. He is presently employed with Gibson Land and Cattle Co. of Comanche, where the couple will make their home. Miss Wood is the granddaughter of Mr. and Mrs. Gene Lowe and Mr. and Mrs. Willis Wood of Muleshoe.

Burnetts Observe Golden Anniversary

Mr. and Mrs. John Burnett were honored Sunday, Nov. 11 on their 50th. wedding anniversary with a reception in the community room of the First National Bank of Sudan.

Mr. and Mrs. Charles Burnett and Mr. and Mrs. Carl Burnett, Gina and Melanie hosted the event for their parents and grandparents. Some 200 friends and relatives called throughout the evening.

The serving table was covered with a gold cloth atop an off white lace cloth and accented with a gold candle with the anniversary invitation outline with gold braid and a 50th. anniversary emblem in the center of the net covering around the candle. The candle was a gift made for the couple by a niece, Mrs. Barbara German, and her mother, Mrs. Sylvia Burnett of El Paso.

The three tiered heart shaped wedding cake was decorated with gold roses, cupids, wedding rings and topped with a gold 50 surrounded with gold lace.

The cake and punch were served from crystal and gold appointments.

The groom's table was covered with an off white lace cloth and chocolate cake and coffee were served from crystal and brass coffee service.

The cakes were made by Laverne Burnett of Causey, N.M. Registering the guests was Melanie McKillip, granddaughter and alternating at the serving tables were Gina McKillip, granddaughter; Step-

hanie Green, a niece from Littlefield; Jeannette Tucker of Mullins, Tex., a cousin, and Christie Pierce of Littlefield.

Mrs. Burnett's brother, Ott Blackman of Globe, Ariz. provided special organ music throughout the evening.

A special memory table was set with old pictures, the Bible that was a wedding gift from Mrs. Burnett's parents on the day they were married, and the book that was made for Mrs. Burnett when she was given their wedding shower.

HOLIDAY TURKEY COSTS MORE THIS YEAR--After two years of bargain prices for holiday turkeys, shoppers may be surprised to find that they cost more this year. "Consumers can expect to find 20-25 percent higher prices for turkeys this year," says Dr. David Mellor, Texas A&M University

Agricultural Extension Service poultry specialist. Last year's lower prices were due in part to a plentiful supply of turkeys in storage. This year, the excess supply is gone, although consumers won't have any trouble finding turkey in the supermarkets, Mellor says.

**New Shipments Just In
Time For Christmas**
Antique Lace Pillows
From Pat Thompson Originals

The Company Store Gift Items
Antiques & Junk

109 S. 1st. 272-5275

**FRESH CUT
Christmas Trees**
Make Christmas Memorable With
A Tree From
Our Large Supply

We Also Have:
Flocking
Tree Stands
Tree Preserver

Happy Holiday Season From
Baker Farm Supply

1532 W. Amer. Blvd. 272-4613

Ana's Is Proud To Announce The Association Of Elyse Kelley. She Specializes In

Perms, Haircuts, Hair Coloring, Sculpture Nails & Manicures.

She Welcomes All Walk-Ins, Monday - Friday.

Ana's House Of Beauty

109 E. Ave. B 272-4152

Give Meat For Christmas !!

Be Sure To Check Our Low Hamburger Specials Every Week

35 lb Family Pack \$69.99

20 lb Freezer Pack \$36.99

Sausage 2 LB. Bag \$1.50 lb.

We Have Smoked Turkeys For Sale

Country Style Pork Ribs \$1.69 lb

Smoked Brisket \$2.69 lb.

Let Us Process Your Wild Game!

We Have Gift Certificates Available.

Winkler Meat Co.

401 Main 272-4703

True Value Hardware Stores

BARGAIN OF THE MONTH

TOOL VALUE OF THE MONTH

HARDWARE VALUE OF THE MONTH

9.99 While Supplies Last
5-Pc. Completer Set Includes frost white 12 1/2-in. serving platter, 2-qt. bowl, covered sugar and creamer. **QUANTITIES LIMITED**

9.99 While Supplies Last
Thermogrip Electric Glue Gun Auto. thermostat, 60-second bond, large capacity. 207MM **QUANTITIES LIMITED**

17.99 While Supplies Last
Fan-Forced Electric Heater Puts warmth where you need it! Auto. temp. control, 360° tip-over shutoff. 1320 W. HR10B **QUANTITIES LIMITED**

Fry & Cox, Inc.

401 S. 1st.

272-4511



LEARNING LIFESAVING AND EVACUATION--On top of the overturned car, Bill Kinard, Muleshoe Fireman, is operating the Jaws of Life, and slowly opening the door of a deliberately overturned car showing firemen the correct way to operate the lifesaving device. Other firemen and EMTs are pictured as they watch the process. This was the first of combined drills to be held for the Muleshoe Fire Department, EMT's and law enforcement personnel.

Muleshoe...

Con't From Page 1

take any section or all five sections during the testing period. More information may be obtained from Linda Marr at Muleshoe High School at (272-3080).

GED testing will not be scheduled again for Muleshoe until April, 1985.

According to the Muleshoe Post Office, they will be maintaining hours on Saturday, December 8, and again on Saturday, December 15.

On those days, the post office will be open 8:30-12 noon.

SFC Randy L. Williams talked with his mother, Cleta Williams, Thursday morning from Walter Reed Army Hospital in Washington, D.C.

He told her testing was continuing in an effort to find therapy to help his back. He spent nearly two months at the hospital in Washington before being sent back to Panama.

Sgt. Williams was flown back to the Walter Reed Army Hospital last week.

Edd Edmiston underwent 'balloon' heart surgery at St. Mary's Hospital in Lubbock Thursday. He is currently in the CCU unit at that hospital.

Thursday, December 13, at 7 p.m., all junior high and high school bands will be presenting a special 'Christmas Concert' in the Muleshoe High School auditorium.

MHS Band Director Anthony Gibson, commented, "The music will all be especially for Christmas. After all, what's Christmas without music?"

The bands encourage everyone to turn out for the concert.

Scout...

Con't From Page 1

Williams, two silver Wolf arrow-points; Gilbert Rennels, Randy Singleberry, Steven Wauson, David Lutz, David Ramirez, Brian Rasco and Eric McElroy, received two year service stars.

In Webelos, Albert Garza earned Aquanaut and Outdoorsman; Mark Hicks, Naturalist and Outdoorsman; John Howland, Aquanaut, Outdoorsman, Forrester and Artist; Ross Parish, Athlete, Outdoorsman, Sportsman and Traveler; Jon Robin Watkins, Naturalist and Sportsman; and Jason Ziegenfuss, Forrester, Sportsman and Traveler.

O give thanks unto the Lord, for he is good: for his mercy endureth forever.
-Psalms 107:1.

Fire...

Con't From Page 1

He also said the Muleshoe EMT Association and West Plains Medical Center commended the department for their help on the accident on Saturday, November 17.

Peterson added, "The Muleshoe Publishing Co. also made mention of the effectiveness of the department two weeks ago in the Journal. The Department wants to thank these people for their backing and appreciation. These organizations also play an important part in our community."

The fire department report continued, "The Christmas season is here once again and fires and accidents seem to be on the increase. We want everyone to have a Merry and happy holiday season and everyone will have to make a great effort toward this end. Make sure electrical lighting and cords are in good shape and other decorations are used correctly and fire safe. "We want to ask for more

SPS...

Con't From Page 1

generates significantly greater proportions of its electricity at coal-fueled plants. The company will bring a new coal-fired power plant unit into service in August 1985, and plans still another for service in the early 1990s.

Presently, coal fuels the boilers at two SPS power plants, near Amarillo and near Muleshoe, generating about 56 percent of the company's electricity. Natural gas fuels the boilers at the company's other power plants.

The coal-fueled plants generate significantly less expensive electricity than do the natural gas-fueled plants. Ballengee said. "Our fuel costs at the coal-fueled plants are less than one-half of the fuel costs at the natural gas-fueled plants. Our coal-fueled plants are playing a major role in keeping electricity affordable."

He said the newly renegotiated contracts with the Burlington Northern and the Santa Fe railroads, signed last week, are particularly important because in recent years the cost of transporting coal by rail from Wyoming to the Texas power plants had grown higher than the costs of the coal itself. "For our customers' sakes, we had to reverse that trend," Ballengee said.

cooperation and consideration and common courtesy from spectators and all responsible departments involved in any way at fires and accidents. This

includes going to and leaving the scene. We want to thank the law enforcement agencies for their help in these emergencies," he concluded.

A&M Five Point
Hi-Protein
Dog Food
50 lb. Bag
\$9.75

Texaco Presents The 1984-85 Metropolitan Opera Radio Broadcast Schedule.

DATE	OPERA	(MST)	DATE	OPERA	(MST)
1984			Feb. 9	La Bohème (Puccini)	12:00
Dec. 1	The Met Marathon	12:00	Feb. 16	Lohengrin (Wagner)	11:00
Dec. 8	Il Barbiere di Siviglia (Rossini)	12:00	Feb. 23	Eugene Onegin (Tchaikovsky)	12:00
Dec. 15	Elektra (Strauss)	12:00	Mar. 2	Manon Lescaut (Puccini)	11:00
Dec. 22	Così fan tutte (Mozart)	12:00	Mar. 9	Ernani (Verdi)	12:00
Dec. 29	Simon Boccanegra (Verdi)	12:00	Mar. 16	Die Meistersinger von Nürnberg (Wagner)	10:30
1985			Mar. 23	Porgy and Bess (Gershwin)	12:00
Jan. 5	Ariadne auf Naxos (Strauss)	12:00	Mar. 30	Tosca (Puccini)	12:00
Jan. 12	La Clemenza di Tito (Mozart)	12:00	Apr. 6	Rigoletto (Verdi)	12:00
Jan. 19	Wozzeck (Berg)	12:00	Apr. 13	Lulu (Berg)	12:00
Jan. 26	Les Contes d'Hoffmann (Offenbach)	12:00	Apr. 20	Parsifal (Wagner)	10:30
Feb. 2	Otello (Verdi)	12:00			

All are Saturday matinee performances. Schedule subject to change.

The season opens once again with "The Met Marathon," featuring highlights of past broadcasts and interviews with special guests.

For a free illustrated broadcast guide, call toll-free 1-800-MET-1984. Please send your quiz questions to the Texaco Opera Quiz, 2000 Westchester Ave., White Plains, NY 10650.

Your ticket to The Met for 45 years.

All fm stations will broadcast in stereo. Tune In KENW-FM 89.5

NEW STORE HOURS
7:30 A.M. till 7:30 P.M.
MONDAY THROUGH SATURDAY

Special Year End SALE!!!!
On 1984 Model P&R Surge Valves

New 8" Units	\$1000
Reconditioned Units	\$790

These are offered only on a first come basis and there is a very limited supply. The 1985 models will be available soon and P&R wants to liquidate their present inventory quickly!!!!

These units are high quality two program systems with complete warranty. The unit is cast aluminum with controls sealed in a mounted casing. The electronic microprocessor is simple to program and displays the exact irrigation sequence. The efficient design diverts water with a minimum of turbulence and no back pressure.

See or call Pivot Products today to take advantage of this fantastic sale!!!

Pivot Products Inc.
W. Hwy 34 272-5536

Send
Galante

Send Muleshoe To Those Special Persons On Your Christmas List.

Bobby Free Farms, Inc.

Will Package & Send A Case Of
16 Oz. Jars Of Galante Picante Sauce Or 9 16 Oz. Jars Of Picante Sauce And 3 Jars Of Galante Diced Jalapeños To The Destination Of Your Choice.

\$24.00 Per Case
Covers Packaging, Shipping and Product

Call 965-2131 With Your List or Come 3 1/2 Miles East On Hwy 70

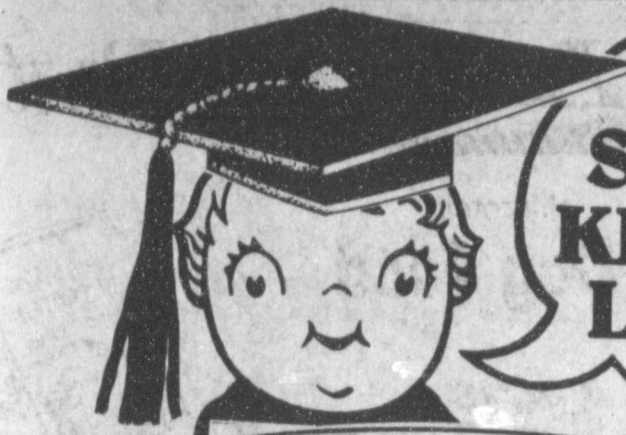

**HELP
SCHOOL
KIDS SAVE
LABELS**



LET'S HELP OUR KIDS HAVE THE BEST!!



Invest In The Future Of Our Kids

by helping to collect

LABELS FOR EDUCATION

By Bringing In Your Labels We Collect Bonus Points
For The School The Bonus Points Help Provide
Aids For Learning For Muleshoe's Future

76,000 Labels Have Been Collected
In The Last Two Years

**BECAUSE OF THESE LABELS, OUR
SCHOOLS HAVE RECEIVED--**

- ★ Books For The Library
- ★ 5 Cassette Players & Recorders
- ★ Video Player & Recorder
- ★ 2 Dukane Sound Film Strip Projectors

YOUR LOCAL GROCERS, ALONG WITH MR. MIKE
RICHARDSON AT WATSON JUNIOR HIGH, WILL BE
COLLECTING LABELS FROM FROM -

- Campbell's Soup - Campbell's Beans - Swanson TV Dinners
- Franco American Products - V-8 Juices -
- Swanson Chicken & Beef Broth

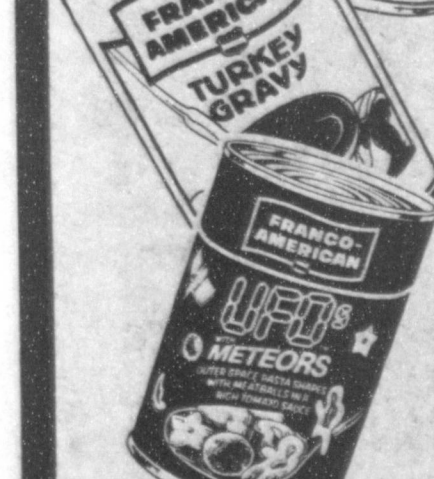
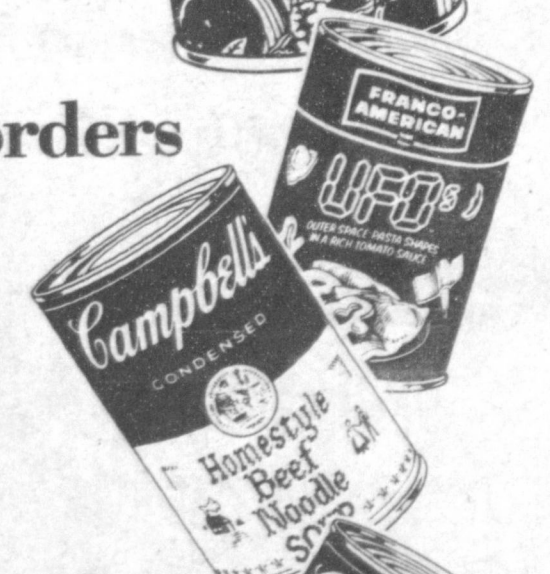
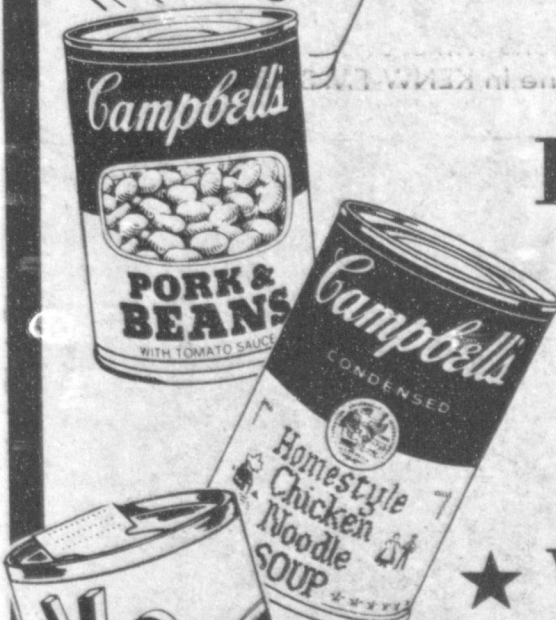
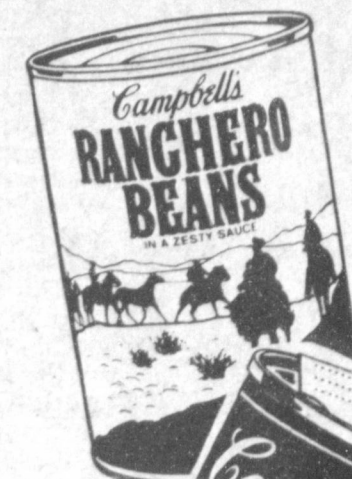

**Thurman Bartlett
Funeral Services
Held Wednesday**

Funeral services for Thurman Bartlett, 81, were held at 2 p.m. Friday, Nov. 30 in Ellis Funeral Home Chapel of the Chimes with Andy Rodgers of Antlers, Okla. officiating.

Interment was in Lazbuddie Cemetery under the direction of Ellis Funeral. Bartlett died at 6:37 a.m. Wednesday in West Plains Medical Center following a lengthy illness.

A native of Tennessee, Bartlett was born June 2, 1903, and moved to Muleshoe in 1967, from Lazbuddie. He was a farmer and a member of the Friona First Baptist Church. He married Thelma Melton on May 3, 1925, in Southland.

Survivors include his wife, Thelma; one daughter, Mrs. Raymond McGehee of Lazbuddie; two sisters, Mrs. Lucy Owens of Seymour and Mrs. Ella Mae Gregory of Crane; two brothers, Lee Bartlett of Brownfield and Cecil Bartlett of Lubbock; one grandchild; and one great grandchild.

**Former Muleshoe
Resident Dies
In Oklahoma**

Services for W.W. (Bill) Bates of Frederick, Ok. were held at 2:00 p.m. Nov. 20 in Gray-Kiesau Chapel. Interment was in Davidson Cemetery.

Bates died at 11:30 p.m. Sunday, Nov. 18 in the Tillman Co. Hospital in Frederick, after a brief illness.

He is survived by his wife, Alva of Frederick; a daughter, Winona Eubanks of Avery, Tx.; four grandchildren; and seven great grandchildren.

He was a former resident of the Fairview Community where he farmed, later retiring and living in Muleshoe.

Grand Jury indicts Labor Secretary Donovan.

**Lazbuddie
Honor Students**

- 2nd Six Weeks Honor Roll
Lazbuddie Junior High
And High School
- 6th Grade--Audra Allen, Casey Bradshaw, Britt Engeling, Trey Hinkson, Stacie Hodges, Juanita Ramos, Casey Russel and Jana Vise.
- 7th Grade--Julie Harris, Lanse Ivy, Mia Jennings, Chris Locke, Kevin McGehee and Eddie Zomora.
- 8th Grade--Jim Allen, Ofelia Dela Fuente, Elizabeth Gauna,

**Local Woman's
Mother Dies
At Lubbock**

Funeral services for Eva Lois Harrison, 70, of Lubbock are pending with Rix Funeral Directors of Lubbock.

Mrs. Harrison died at 11:30 a.m. Wednesday at Methodist Hospital in Lubbock as a result of injuries sustained in an automobile accident Sunday.

She was married to Hugh Vergil Edwards. He died on Nov. 24, 1954. She married R.E. Harrison on Sept. 20, 1962, in Levelland. He died May 23, 1979. She had been a resident of Lubbock 42 years and was a member of the Southcrest Baptist Church, where she was active in many church-related functions. She was a member of the Jolly Elders Sunday School class.

Survivors include one son, Ronald Edwards of Carrollton; two twin daughters, Mrs. Elvis (Billie) Powell of Lazbuddie and Mrs. Gary (Bobbie) Jones of McAllen; two brothers, Dearn Richardson of Dallas and Arvil Richardson of Portales, N.M.; three sisters, Mrs. Harold Brown of Cumberland, Md., Mrs. Fred Hanger of San Antonio and Mrs. Ray Deene of Monterey, Calif.; and six grandchildren.

Brian Glover, Connie Gonzales, Jonessa Jennings, Ginger Jesko, Susan Redwine and Scott Miller.

9th Grade--Amy Daniel, Chris Fuqua, Ana Hernandez, Tim Lust and Omar Sanchez.

10th--Dusty Jesko, Traci Elliott, Cami Ivy, Shane Mason, Kristine Miller, Cathy Schacher and Elva Trevizo.

11th Grade--Aaron Hargett, Scott Holt, Wendy Jarman, Lisa McGehee, Sandra Nail and Melissa Schez.

12th Grade--Chandra Engeling, Cheryl Holt, Maureen Jesko, Carolyn Nail, Becky Schacher and Rhonda Waddell.

**West Plains
Hospital Report**

Nov. 27--Craig Denney Hattie Jones, Bernice Hawkins, Mario Contreras, Dana Arnold, Geneva Thomasson, Kirk Dean, Frank Parker and Joe Crutcher.

Nov. 28--Craig Denney, Danny Guerra, Joy Morton, Pamela Trevizo, Jessie Sanders, Gloria Torres, Murphy Berry, Hattie Jones, Geneva Thomasson, Mario Contreras, Dana Arnold, Nora Burch, Sonovia DeHoyos, Robert Gonzales Jr., Kirk Dean and Joe Crutcher.

Nov. 29--Danny Guerra, Ramon Villarreal, Joy Morton, Pamela Trevizo, Jessie Sanders, Gloria Torres, Murphy Berry, Hattie Jones, Geneva Thomasson, Mario Contreras, Dana Arnold, Nora Burch, Darlene Miller, Robert Gonzales Jr., Lena Cole, Myrtle Clayton and Joe Crutcher.

Don't Stand Still
Subtlety is the art of saying what you think and getting out of range before it is understood.
-W.O.W. Magazine
Isidore damages Carolina beaches more than Diana.

Ellis Funeral Home
Pre-Need Funeral Plans
Supervised By Texas Department Of Banking
Price Frozen At Time Of Purchase

J. L. C. Company

Diamond Earrings		Diamond Pendants	
6 prong -14K Gold Mountings		6 Prong-14 K Gold Mountings (Chain included)	
.10 ct.	total weight \$99	.15 ct.	\$139
.20 ct.	total weight \$167	.20 ct.	\$199
1/3 ct.	total weight \$299	1/3 ct.	\$399
1/2 ct.	total weight \$449	1/2 ct.	\$659
3/4 ct.	total weight \$689	3/4 ct.	\$959
1.00 ct.	total weight \$1099	1.00 ct.	\$1499

213 S. 1st.
Muleshoe, Tx

25% Discount with this ad.
Nov. 30th thru Dec. 8th.

True Value

HARDWARE STORES

Hardware Gifts

Your local independently owned True Value® Hardware Store has national chain-buying power.

Stop in for your FREE copy of our Fall Shopper circular

**Sharp
Microwave
Oven**



Reg. \$549⁹⁵
\$449⁹⁵



16⁸⁹
Sportsman's Axe
One-piece forged tool steel with genuine leather grip. 1 3/2 in. long, 24 oz. E24A



True Value
199
Happy Holidays Album or Tape

Outstanding collection of holiday music recorded by many of your favorite artists. Makes a great gift for anyone who loves music, or add it to your own music library. Vol. 19

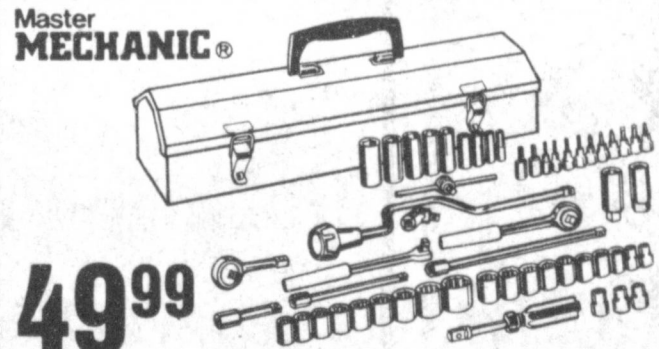

49⁹⁹
57-Pc. 3/8-In. SAE/Metric Socket Set
Everything you'll need: 21 SAE and 10 metric sockets, spark plug sockets, 3 quick-release ratchets, 3 extensions, flex handle, universal joint, spinner, speeder, metal toolbox, more. 3857



9⁹⁹
George Bignotti 7-Pc. Screwdriver Set
Professional quality for the do-it-yourselfer. Includes 4 slotted, 3 Phillips tips. MMP7



39⁹⁹
5-Pc. Cutlery Set
Quality set incl. French cook's, paring, boning and slicing knives in wood slant block. 276



89⁹⁹
2-Drawer Tool Chest
Drawers lock when lid is closed. Extra storage in top till. 22L x 10H x 9 1/2 D in. MM902. 29.99

**Drawing for the
Cabbage Patch
Doll & G.I. Joe
Trucking Set**
will be December
**22nd, at noon
for Boys & Girls
(Age 15 & Under)**



True Value
149
Alkaline Batteries
For long-lasting energy.
2-Pk. C or D. TV1400/1300B2
4-Pk. AA. TV1500B4
1-Pk. 9-Volt. TV1604B



**Hoover Concept Two
Vacuum Cleaner**
Reg. \$295⁰⁰
\$279⁰⁰



77^c
Fashion Paper
Single roll in many styles and colors. 20 sq. ft. 77722



8⁹⁹
12-Ft. Booster Cable
All-copper 10-gauge emergency cable to keep in trunk. ST1012



2⁹⁹
Workhorse™ Flashlight
Heavy-duty 2-cell flashlight has bright Krypton bulb. WH25

We Also Have Gift Certificates

Fry & Cox, Inc.

401 S. 1st.



272-4511

**Welcome Hunters
Pheasant Season**

Dec. 8 - 23rd
(3 Cocks per Day)
(6 in Possession)

We Want To Thank All
Of You For Making Us Your
Hunting Headquarters.

It's Always A Pleasure
To See You And Your Out-Of-
Town Guests. Let Us Know
If We Can Assist You In
Anyway.

**Open 6 am
Sat Dec. 8**

- ★ Hunting Licence
- ★ Shells
- ★ Guns
- ★ Game Bags, etc.

POYNORS

103 Main Street WHITE'S STORES, INC. Muleshoe, Texas 79347

Courthouse News

MARRIAGE LICENSE
 Feliciano Reyes, Jr. and Maria Teresa Davila, Amherst Glenn Downing Hughes, Albuquerque, N.M. and Imogene Jessie Spaccamonti, Pueblo, Colo.

Alejandro Valdez and Esperanza Arellano, Muleshoe Terry Gene Martin and Sandra Kaye Haynes, Clovis, N.M.

Jack Arthur Tillema and Grace Leniore Gordon, Muleshoe

WARRANTY DEEDS

Kenneth R. Box and wife, Lynne R. Box to Royce L. Turner and wife, Sandra B. Turner--All of the (NW 1/4 38') of Lot Number (94), and the SE 1/4 30' of Lot Number (95), Richland Hills Addition to Muleshoe, Bailey County, Texas.

Gerald Reid and Thursie Reid to Ofelia Leal Orozco--All of Lot Number (10), and the S 15' of Lot Number (11), in Block Number (6), Hillcrest Addition Number (2), in the Town of Muleshoe, Bailey County, Texas.

Ofelia Leal Orozco to Elias Noe Anzaldua, Jr.--All of Lot

Number (10), and the S 15' OF Lot Number (11) in Block Number (6), Hillcrest Addition Number (2), to the Town of Muleshoe, Bailey County, Texas.

COUNTY COURT

Florentino Campoya DWI 30 days jail \$250 fine

Gilbert Recio Possession of Alcoholic Beverage in Dry County \$400 fine

Maximo Mora DWI 30 days jail \$250 fine

Josemaria Serrante Orozco DWI 72 hours jail

Federico Trujillo DWI 20 days jail \$150 fine

Jessie Heredia Order of Dismissal

Elojio Rodriguez DWI 30 days jail \$250 fine

John Randall King DWI 30 days jail \$750 fine

Gordon Elmore Noble DWI 10 days \$750 fine

Domingo Coronau Vasquez DWI \$100 fine 1 year jail Work Release

William Robert Stejskal DWI 72 hours jail \$250 fine

Charles Roy Phares DWI 30 days \$250 fine

LASER NEWS

MIAMI BEACH, FLA. -- A laser that blasts fatty deposits with billionth-of-a-second bursts of intense light may be able to clean out clogged arteries without damaging the patient's blood vessels, fulfilling a major research goal, doctors said recently.

Three-Way News

by Mrs. H.W. Garvin

Mr. and Mrs. George Tyson spent Thanksgiving with their daughter and family the Tommy Durams in Lubbock.

Mr. and Mrs. Adolph Wittner had Thanksgiving in Plainview with their daughter Cathey.

Mrs. Robert Kindle was a patient in Littlefield hospital last week.

Rev. and Mrs. James Gillintine from Lubbock visited her mother in Cochran Memorial Hospital Wed. and Thursday.

Mike Sowder spent Thursday with his parents the Joe Sowders of Goodland.

Belinda Dolle from Lubbock spent the weekend with her parents, the Bill Dolle's and Darla.

Mr. and Mrs. Jack Furgerson from Shallowater spent Thanksgiving with their son and family the Jonny Furgerson's of Three Way.

Mrs. Jane Fox from Clovis, N.M. spent Friday with her mother, Mrs. H.W. Garvin who is a patient at Cochran Memorial Hospital.

Mr. and Mrs. S. G. Long picked up her sister in Amarillo and went to Tulsa for Thanksgiving with two sons and families, also her daughter and son-in-law Dr. and Mrs. Chuck Hancock from Minden, La. met them there.

Buck Tyson and son from Plano spent the weekend with his parents, the George Tysons.

Mr. and Mrs. Paul Wiley and son, of Lubbock and the Charles Latimers of Goodland spent Thursday with the W.E. Latimers.

NOT WHAT IT SEEMS

BUFFALO, N.Y. -- The giant General Nutrition chain of health food stores and three executives were indicted recently on federal charges of promoting and selling an untested product as a drug capable of preventing and curing disease.

Latest shuttle makes history in rescuing two satellites. Nicaragua claims U.S. is going to invade country. Study says space goals narrow and costly.

SPECIAL COW SALE
 Friday, Dec. 7, 11:00 A.M.
 Roswell Livestock Auction

Expecting to sell 1400 Springer Cows, Bred Heifers and Cow and Calf Pairs. Also 50 Bulls.

Early Consignments Include:

- 225 Brangus and Black Whiteface heifers weighing 800 to 850 lbs. Bred to Longhorn bulls. Begin calving Feb. 1.
- 150 Charlois, Angus, and Black Whiteface cows. 6 years old and younger.
- 55 4 to 6 year old Hereford Springer cows.
- 124 Crossbred Bred heifers. Includes 60 Brangus, Balance Braford type. Calfhood vaccinated. Bred to Longhorn bulls. Begin calving Feb. 15.
- 70 Brangus Bred heifers. Calfhood vaccinated. Bred to Longhorn bulls. Begin calving Feb. 15.
- 76 Braford bred heifers. Calfhood vaccinated. Bred to Longhorn bulls. Begin calving Feb. 15.
- 40 6 year old Hereford and Black Whiteface Springer cows.
- 14 Young Brangus pairs.
- 35 nice 2nd calf crossbred cows.
- 45 Reputation older Brangus Springer cows.
- 36 4 to 7 year old Brangus cows. Bred to Hereford bulls. 30 calves on the ground.
- 30 3 year old Hereford cows. 1/2 calved out.
- 42 5 year old Black Whiteface cows. Bred to Beefmaster bulls.
- 25 3 to 4 year old Brangus cows. Bred to Brangus bulls.
- 27 5 to 7 year old Brangus cows. Bred to Brangus bulls.
- 35 Black Whiteface cows. 5 to 7 years old. Bred to Beefmaster bulls.
- 24 Charlois cross cows. Bred to Beefmaster bulls.
- 25 Angus cows. Brangus and Beefmaster bulls.
- 30 Bra-cross cows. 5 to 7 years old. Bred to Brangus or Beefmaster bulls.
- 15 Hereford and Black Whiteface cows. 3 to 5 years old.
- 25 Crossbred pairs. 5 years old. Calves out of Simmental or Limousin bulls.
- 30 5 year old crossbred cows. Bred to Limousin or Simmental bulls.
- 200 older ranch cows. Pregnancy tested. Ideal to put on field and calf out.
- 2 registered Beefmaster bulls. 3 to 4 years old.
- 10 coming 2 year old Brangus bulls.
- 11 coming 2 year old Braford bulls.
- 4 2 year old Simmental bulls.
- 6 2 year old Brangus bulls.

For More Information Contact:

Dick Moore-Auctioneer
 505-359-0950

Larry Wooten-Owner
 Roswell Livestock Auction
 505-622-5580

Whitt - Reid
 REAL ESTATE INSURANCE
 Built On Integrity & Service
 201 Main 272-3611
 HOMES FARMS RANCHES LOTS COMMERCIAL

40 acres, w/irrigation well, side roll sprinkler, one mile north of Earth highway, near Tolk Station, ideal place to build country home. Owner says sell....

6 acres † on West Camp Highway, Land only, suitable for farm home. Nice place to build.

Nice 3B 1B in country. with bar, dishwasher & utility room, strom windows on large lot.

2-1-1 Partial brick in front-large kitchen

Ceramic shop doing good business.

We have other houses, farm's and lot's.

H.C Reid Broker
 Roy Whitt 272-3058
 Thursie Reid 272-5318
 Joy Whitt 272-3058

"We Try Harder"

Christmas Sale

Gigantic

13 1/2 ft. Round

Quality You Can See

Performance You Can Feel

For Fun and Fitness

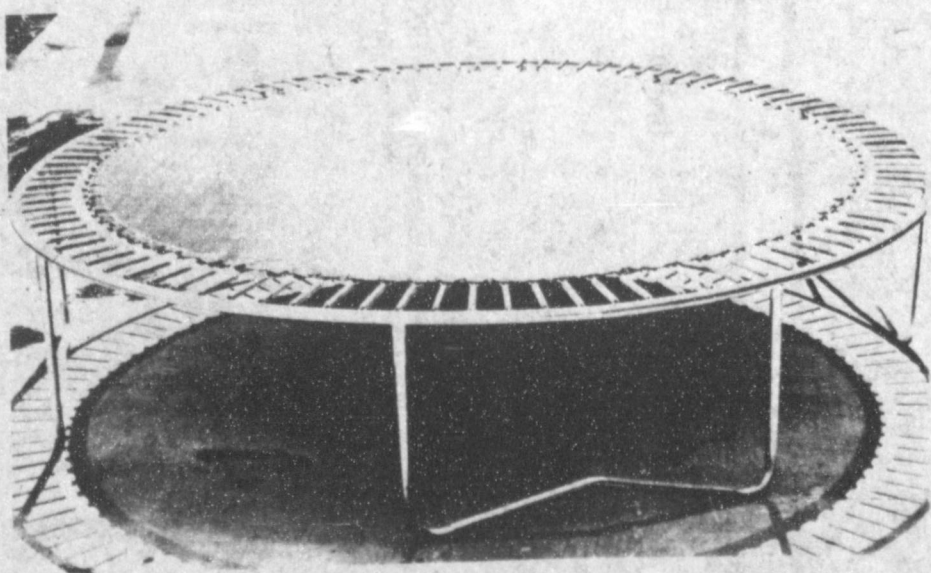

5 YEAR WARRANTY

\$399⁰⁰

Suggested Retail \$599.95

P O Y N O R ' S

WHITE'S STORES, INC.

Muleshoe

103 Main Street

Computerrific School Program

It's Easy To Earn FREE IBM PC Jr. Systems.

Simply Collect Proofs-Of-Purchase From The Well Known Products Listed Below. Many Of These Brands Are Already Found In Almost Every Home.



Help Our School Earn FREE IBM PC Jr.

Computer Systems

The Drive Is Sponsored By Procter & Gamble With The Participation Of IBM.

Here's How You Can Help:

1. Save The Universal Product Codes From Participating Brands.
2. Save Specially Marked Pull-Off Tabs From Crush Cans.
3. Take Your Proof Of Purchase Seals To Your Store And Deposit Them In The Specially Marked Box.

Proof-Of-Purchase Seals A Will Be Picked Up Each Friday By The Gifted & Talented Class From Mary De Shazo.

Help Our Children Get Ahead - Join The Computerrific Program.



CLASSIFIED ADS

DEADLINE FOR CLASSIFIED ADS IS TUESDAYS AND FRIDAYS 12:00 NOON

CLASSIFIED RATES
1st Insertion Per Word....\$1.15
Minimum Charge....\$2.30
2nd Insertion Per Word....\$1.13
Minimum Charge....\$2.00
CLASSIFIED DISPLAY
\$1.70.... per column inch
BLIND AD RATES
50% more
DEADLINES
12 Noon Tues. for Thursday paper
12 Noon Fri. for Sunday paper
WE RESERVE THE RIGHT TO CLASSIFY REVISE OR REJECT ANY AD NOT RESPONSIBLE FOR ANY ERROR AFTER AD HAS RUN ONCE

FURNITURE Upholstering & Repairs
Burrows Upholstery Shop 209 W. 2nd Phone 272-4255 Home Phone 272-5722. b1-41t-tfc

MARY KAY Cosmetics, Shop now for your Christmas selections, Free gift wrapping, Free Complimentary Facial call Yolanda Bell Beauty Consultant 925-6664. b1-45t-tfc

I will no longer be responsible for debts incurred by anyone but myself.
Holly Ann Millsap

Open your own highly profitable Children's Shop. Baby to Pre-Teen. All first quality merchandise. Nationally known brands.
*Health Tex *Buster Brown *Her Majesty *Lee *Levi *Chic *Jordache *Rob Roy *Izod and many more. \$14,900.00 includes beginning inventory - training - fixtures and grand opening promotions. Have your store opened in as little as 15 days. Prestige Fashions 501-329-8327. 1-49s-1tpts

3. HELP WANTED
Lose Weight, feel great. Look good for the holidays. All natural, no drugs. More information call: 965-2866 Don't Weight! s1-49s-2tsp

7. WANTED TO RENT
Prepared childbirth classes to be held Dec. 11, 18 and 20, 7 to 9 pm at West Plains Medical Center lobby. For more information contact Diane Gonzales at 272-4847 or Richelle King at 272-4449. k1-49s-2tc

8. REAL ESTATE FOR SALE
CONCERNED About Someone's Drinking **HELP IS AVAILABLE** through Al-Anon Call 227-2350 or 965-2870 or Call 227-2350 or come to visit **Tuesday** nights. 8:00 p.m. at 1116 W. American Boulevard, Muleshoe

2. LOST & FOUND
LOST: Ladies purse. Finder please keep money, return purse and contents. Receive \$50.00 reward. Call 965-2631. 2-49s-2tp

3. HELP WANTED
GENERAL OFFICE WORK: Light book-keeping, 45+ typing required. Neat, pleasant voice. Send resume to P.O. Box 449, Muleshoe, TX 79347

7. WANTED TO RENT
WANT to rent: 3 bedroom house in the country or with a fenced back yard. Call 246-3256 after 7:00 p.m.

8. REAL ESTATE FOR SALE
FOR SALE: House on 1 acre; 3 br, 2 full baths, large den w/fireplace, built-ins and gun cabinet; Kitchen has all built-in appliances. Large storage room in back. Cinder block around house and lots of trees. Call 272-3318. s8-47t-5tc
FOR SALE in Sudan: Nice three bedroom. Two full baths, fireplace, storage house and carport. If interested call 227-2124. 18-46s-8tc
FOR SALE: By owner 3-1-1 house on 1 acre 3 miles N. of Muleshoe. 30's 272-5042 18-47s-tfc
FOR SALE BY OWNER 2-1-1 on 2 lots. All fenced yard, storage building, fruit trees. \$17,500. Call 965-2320. 18-41s-stfc

J.B. SUDDERTH REALTY INC.
Drawer 887
Farwell, Tx. 79325
Ph. 806-481-3288
HAVE BUYERS NEED LISTINGS
80 Acres, 2 wells, 1 electric motor, West of Muleshoe on highway. Owner says Sell!
480 Acres Irrigated with Circle Sprinklers, lays good, on highway-West of Muleshoe. Owner says Sell!

Good 320 acres with 2 circles 2-8 in wells on highway South East of Lazbuddie. \$975 per acre cash with circle sprinkler included.
Good 320 acres Irrigated, 2-8 in wells, located north of Texico on highway.
160 acres, 8 in well with circle sprinkler, good water area South East of Oklahoma Lane crossroads.

160 acres, 2-8 in wells, underground pipe, lays excellent. South of Farwell on highway.
160 acres, 8 in well and 10 tower zimmerman circle sprinkler near Oklahoma Lane Farm Supply. Excellent financing.
Good investment. Best money making well stocked farm supply business in the area. Well established strategically located on FM2 right in the heart of the best irrigated farm land in Parmer County. Great family operation. Included are 2 beautiful 3 bedroom ranch style brick homes and several large steel barns. Owner says sell and will finance.

Excellent 171.5 acres. 1-8 in well, 1-6 in well, with electric motors near Lariat.
158 acres irrigated with seven tower valley sprinkler and a nice 3 bedroom, 2 bath brick home on highway near West Camp Gin.
277 acres some irrigated, some grass 6 miles north of Bovina. Priced to sell. Owner says sell immediately.

JIMMIE CRAWFORD
Real Estate & Ins.
1725 W Ave E
Muleshoe, Texas
Phone 272-3666

3-1 Brick with tile fence and garden. 1600 Sq. Ft. Good price-\$39,500.
3-1/2-2 Brick with carport. Price reduced-\$45,000.

2-1-1 with fenced back vd. 930 Sq. Ft. \$26,000.
2-1 with large utility. 938 Sq. Ft. \$17,500.

2 labors dryland west of Enochs. 1/2 minerals.
160 acres west of town with 2 wells. Good price.

320 acres N.E. of town with 3 wells. Good land.
154 acres west of town with 4 wells. All waters.

SMALLWOOD REAL ESTATE
232 Main
272-4838
3 B.R. Brick, 2 Bath, 2 Car Garage, 2 Storage Bldg. Central heat Refrigerated air, Fireplace, Electric Garage door openers, fenced back yard, good location, Priced to Sell!
8-23s-tfc

KREBBS REAL ESTATE
1004 W. 6th
Phone---272-3191
Appraisals
We Specialize In Farms And Ranches

20A Native Grass - Hwy 84 ***
150A Good Red Land-Lariat area. ***
Hog farm-completely automatic, E. of Muleshoe-Terms. ***
Builders Dream - Plotted lots - Ready to build on - Hwy 84 ***
Large tract of dry land - S of Muleshoe. 8-15s-stfc

HENRY REALTY
111 W. Ave. B
Muleshoe, Texas
272-4581

320 Acres with large beautiful 3 - Bedroom, 3 bath, 3 car garage, spacious gameroom, central heating and air, underground sprinkler for yard 30' x 50' shop for building. 5 wells. ***
80 ACRES with 6' well and 8' well, under ground pipe owner financing available. 7 miles west of Muleshoe. ***
160 ACRES with 2 wells and 7 tower sprinkler near Lazbuddie. ***
38 Acres West of Muleshoe, 6 Inch Well, Sideroll, All Wheat. ***
One Acre Sites for Home Construction. 3 Miles of Muleshoe on HWY, 3 lots remain. ***
Completely remodeled 2 Bed room home. Ideal first home, must see to appreciate. Nice location with F.H.A. loan. ***
Apartment complex, mobile home park, vacant land for expansion. Terms available. 8-23t-tfc

Excellent 171.5 acres. 1-8 in well, 1-6 in well, with electric motors near Lariat.

158 acres irrigated with seven tower valley sprinkler and a nice 3 bedroom, 2 bath brick home on highway near West Camp Gin.

277 acres some irrigated, some grass 6 miles north of Bovina. Priced to sell. Owner says sell immediately.

3-1 Brick with tile fence and garden. 1600 Sq. Ft. Good price-\$39,500.

3-1/2-2 Brick with carport. Price reduced-\$45,000.

2-1-1 with fenced back vd. 930 Sq. Ft. \$26,000.

2-1 with large utility. 938 Sq. Ft. \$17,500.

2 labors dryland west of Enochs. 1/2 minerals.

FOR SALE: Maytag dishwasher, one couch. Call 965-2963 after 6:30 p.m. v11-48t-2tc

FOR SALE Firewood, Dry Oak. 272-3987. w11-45s-tfc

FOR SALE 78 ft. Condor Motor home. Self contained. 272-3227 or 272-3113 w11-46t-6tc

High school youth are selling dry wood. Mesquite, Oak, Pinon, Call 238-1620 after 5:00 p.m. s11-45-6tc

13. PROPERTY FOR LEASE

25 BY 140 ft. building on Main Street in Muleshoe for rent. Will remodel to suite. 385-6237 10 to 5 p.m. Littlefield Health Food Center. h13-43s-stfcs

14. FARM PROPERTY TO RENT

IRRIGATED farm land for rent in Lariat area. Call 481-9303 in Farwell. 14-47s-4tp

15. MISC.

WANT TO BUY used 3 bdrm house to be moved. Call Roy Whitt office 272-3611, home 272-3058. w15-44s-stfc

BRUCE & MATTHEWS Inc. Refrigeration & Electrical Contractor's Heating, Cooling, Appliance Service. 424 N. First. 272-5114. 15-44t-tfc
HOME REPAIRS. F.M. Saldana Construction Licensed and bonded plumber. Specialize in cement, carpenter work, remodeling, painting, acoustical ceilings. 272-4955. 15-16s-tfc

The Answer Now Available in Bailey County
Put an end to those missed messages, job opportunities, even time consuming cancellations.
Let me answer and record your daily messages.
Offering:
Efficient Answering
Courteous Service
Confidential Messages
Your chance to have a full time secretary for 1/4 the usual cost. Call me for more information
And never miss another call.
Debbie Green
272-5261
g15-47t-tfc

9. AUTOMOBILES FOR SALE

If you want to be happy, never set your mind upon anything which is in the power of others to withhold.

79 MODEL Hesston 3000 Stripper, clean, \$2500

IH MODEL 95 Cotton Stripper \$10,000

IH MODEL 95 Cotton Stripper, Clean \$12,500

ONE IH MODEL 85 Stripper \$500

ONE 81 MODEL 1400 Stripper Reconditioned & Clean \$25,000

Wooley International
W. Hwy 84
Muleshoe, Texas

w10-44s-tfc

To Get Rid Of Your Unwanted Items
Call 272-4536

BINGHAM & NIEMAN REALTY
116 E. Ave. C
272-5285***272-5286
WE CAN HELP OUR BUYERS WITH
107/8 % A.R.M. INTEREST RATES ON
30 YEAR LOANS!!!!

RICHLAND HILLS

3-1 3/4-1 Brick, Cent. A&H, stove DW, fenced yard. 40's...

3-1 3/4-2 Brick with corner fireplace in den, built-ins, large sunny dining area with built-in planter...

LUXURY LIVING in this 3-2-2 Custom-built brick, loads of built-ins, wet bar, Jacuzzi whirlpool, atrium, basement, Cent. A&H, & more...

3-1 3/4-2 carport Brick, Cent. A&H, built-ins, gas log fireplace, fenced yard!!!

COUNTRY CLUB

3-1 3/4-2 Brick, Cent. A&H, built-ins. \$40's!!!!!!

3-1 1/2-1 Brick, repainted inside & out, built-in range, gas grill, storage bldg. Low 40's!!!!

LENAU ADD.

JUST LISTED--3-1 1/4-1 carport home, nice carpet, fireplace, covered patio, storage bldg., isolated master bdrm. \$30's!!!!!!

3-1-1 home on corner lot, Cent. heat, Evap. air, fenced yard. \$30's.

3-1 3/4-1 carport, nice carpet, fenced yard. a neat well-kept home. 30's !!!!

ENJOY COUNTRY LIVING--3-1 1/4 home on 2 1/2 acres on pavement close to town, Cent. A&H, built-ins, & other extras!!!!!!

2-1-1 home on corner lot, close to schools. Priced to Sell!!!!

3-1-1 home, Cent. A&H, paneling, nice carpets, fenced yard, storage bldgs. \$20's!!!!

3-1-1 home, corner lot, built-ins, Cent. A&H, nice carpet. 30's....

OWNER FINANCING--2-2 1/2 carport Mobile home, built-ins, Cent. A&H, utility, covered porch, storage bldg., shop, fenced yard. Close to schools!!!!!!

HIGH SCHOOL AREA--3-1 home, new roof, carpets, & interior paint, built-in DW, large rooms, & also has nice insulated workshop. \$20's!!!!!!

JUST LISTED--320 acres good cultivated land, near Stegall area in Roosevelt County, N.M. \$250 per acre....

EXTRA NICE--2-1 1/1 carport home, new paint, countertop, fenced yard & storage bldg. \$19,500!!!!

2-1 3/4 Mobile Home + 2 carport, covered porch, built-ins, cable TV, large barn & corrals on approx. 2 acres on pavement close to town. 30's....

4-1 on 5.3 acres, 5 hp. sub. pump, tractor & equip., barn & more. 40's....

Building on 2 lots, approx. 2350 sq. ft., paved parking!!!!

FARMS

60 acres dryland, close to town.....

80 acres, Stegall area. Good productive dryland farm....

2-1 home on 20 acres, 20 hp. sub. pump, domestic well, large barn & corrals, 1/4 mile sprinkler pipe, & more. \$42,500....

2-1 home on 32 acres, 6" well, close to town on pavement....

120 acres- good 6' well, good farm, close to town. \$700 per acre....

1062 acres, 3 wells, 2 circles, large metal barn, 9% Owner financing....

160 acres, well with 40 hp. Elec. motor. \$400 per acre....

SHOWN BY APPOINTMENT ONLY--
COUNTRY CHARM WITH CITY CONVENIENCE Spacious 4 Bdrm., 2 3/4 Bath, 2 Car Garage Brick Home. Beautifully Landscaped. Approx. 3570 sq. ft. of Lv. area. Dual Cent. A&H units, Cathedral beamed Den with cozy fireplace, large Game Room with portable bar, separate Living, Dining, & Breakfast areas. Nice kitchen with built-ins including BBQ Grill, large Utility Area with pantry & storage. Interior of home is trimmed in pecan wood & paneling & has nice enclosed entry-garden area. Other amenities include thermal windows, large covered patio with gas grill, undrgrd. sprinkler sys., nice workshop with heating & elect., & numerous other extras.

We have numerous other farms, commercial property, & lots listed. Contact us for details on these and other listings.

"WE APPRECIATE YOUR BUSINESS"
GEORGE NIEMAN, BROKER
DIANNE NIEMAN, BROKER

8-40s-stfc

GREAT food IDEAS

SKINNER MED./WIDE/EX. WIDE
NOODLES
 12 OZ. PKG. **59¢**

25% OFF LABEL
LIQUID WISK
 32 OZ. BTL. **\$1.59**

NEW! FABRIC SOFTENER
SNUGGLE
 64 OZ. BTL. **\$1.89**

KRAFT CHEESE SPREAD
VELVEETA
 1 LB. LOAF **\$1.89**

KRAFT HALFMOON LONGHORN CHEDDAR/
COLBY CHEESE
 10 OZ. PKG. **\$1.69**

EXTRA STRENGTH CAPSULES
TYLENOL
 50 CT. BTL. **\$3.59**

32 OZ. PLUS DEPOSIT
COCA-COLA
 6 BTL. CTN. **\$1.79¢**

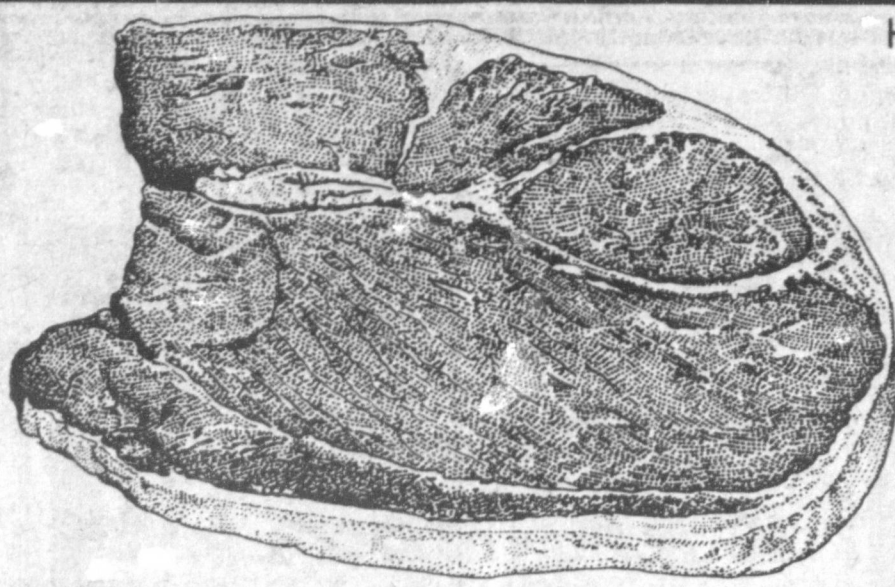

HEAVY GRAIN FED BEEF BONELESS
ROUND STEAK
 LB. **\$1.99**

HORMEL SUPER SELECT FRESH
PORK STEAK LB. **\$1.59**
 HORMEL SUPER SELECT FRESH
PORK BUTT ROAST LB. **\$1.49**
 HILLSHIRE FARM REG./POLISH FLAVOR SEAL
SMOKED SAUSAGE LB. **\$1.99**
 SHURFRESH WHOLE HOG REGULAR OR HOT
PORK SAUSAGE 1 LB. ROLL **\$1.59**

ARMOUR PRE-COOKED CHICKEN FRIED
BEEF PATTIES LB. **\$1.69**
 COUNTRY SKILLET FARM GROWN FROZEN FRESH
CHANNEL CATFISH LB. **\$2.39**

WRIGHT'S HICKORY SMOKED SLICED
SLAB BACON
 LB. **\$1.29**

DEL MONTE BAN./VAN./CHOC.
PUDDINGS
 4 PAK 5 OZ. CANS **89¢**

PERMA SOFT REG./EX. HOLD REG./UNSC.
HAIR SPRAY 7 OZ. CAN **\$1.69**
 30% OFF LABEL
AIM TOOTHPASTE 6.4 OZ. TUBE **\$1.39**
 INTENSIVE CARE REG./HERB./ALOE/X-STR.
VASELINE LOTION 6 OZ. BTL. **\$1.39**
 S-FRAY
NEO-SYNEPHRINE 1/2 OZ. BTL. **\$2.29**
 BORDEN'S ASSORTED
ICE CREAM 1/2 GAL. RD. CTN. **\$1.59**
 BORDEN'S RICH
CHOCOLATE MILK QT. CTN. **59¢**
 BORDEN'S
HOMO MILK 1/2 GAL. CTN. **99¢**
 SUNKIST CHILLED
ORANGE JUICE 64 OZ. CTN. **\$1.89**
 BANQUET ASSORTED
DINNERS 11 OZ. PKG. **79¢**
 LIGHT SPREAD MARGARINE
KRAFT PARKAY 2 LB. BOWL **\$1.29**

ASSTD./WHITE BATH
NORTHERN TISSUE
 4 ROLL PKG. **99¢**

ALL TYPES RUFFLES
POTATO CHIPS
89¢
 \$1.39 SIZE

DEL MONTE VC HALVES OR
SLICED PEACHES 29 OZ. CAN **89¢**
 DEL MONTE FRESH
TINY DILLS 12 OZ. JAR **89¢**
 DEL MONTE
SWEET PICKLES 22 OZ. JAR **\$1.69**
 DEL MONTE
MIDGET PICKLES 12 OZ. JAR **\$1.49**
 MOPSON COOKIES OR
BIS-KITS 2 8 OZ. PKGS. **49¢**
 SUNSHINE CHESTNUTS OR
HI-HO CRACKERS 18 OZ. **\$1.19**

KITCHEN TESTED FLOUR
GOLD MEDAL
89¢
 5 LB. BAG

3% OFF LABEL
 ARMOUR POTTED
MEAT 4 3 OZ. CANS **\$1**

20% OFF LABEL
 ARMOUR
TREET 12 OZ. CAN **\$1.19**

5% OFF LABEL
 ARMOUR VIENNA
SAUSAGE 5 OZ. CANS **2 89¢**

Winner Of The Stamps
 Minnie Redwine
 ALL GRINDS COFFEE
HILLS BROS.
\$5.99
 3 LB. CAN

15% OFF LABEL
CARESS
99¢
 4.75 OZ. BAR

COLORADO ALL PURPOSE RUSSET
POTATOES
\$1.19
 10 LB. BAG

DEL MONTE
TOMATO CATSUP
\$1.59
 44 OZ. BTL.

GREAT SNACK TREAT!
RED ROME APPLES LB. **45¢**
TANGERINES LB. **49¢**
FRESH LEMONS LB. **59¢**



PRICES EFFECTIVE
 DECEMBER 3 THRU 8, 1984
 WE RESERVE THE
 RIGHT TO LIMIT

Sudan News
by Evelyn Ritchie

Recent visitors with Mr. and Mrs. George Collins were their son and daughter-in-law, Mr. and Mrs. George Collins, Jr. of Lubbock and their daughter, Mr. and Mrs. A.M. Johnson and Jerry of Lazbuddie.

Visiting last week with Mr. and Mrs. Dale Newsom were his cousin, Mr. and Mrs. D.C. Newsom of Plains.

Mrs. J.C. Wells was a surgery patient in the Methodist Hospital one day this past week. She had oral surgery, and was to be released later this week.

Thanksgiving holiday guests in the home of Mr. and Mrs. Byron Lynn were her daughters, Pam Alford and Paulette and Paula Jones and Jason all of Fort Worth. Joining them were Mr. and Mrs. Roby Lynn and girls.

COMMUNITY SERVICES
The ministers of Sudan's churches would like to express their appreciation for the overwhelming generosity of those attending the Community Thanksgiving service last Sunday evening. The offering will help minister to the area's needy very well all year long.

With approximately 200 in attendance this was the largest congregation for the Thanksgiving service in many years.

Visiting Tuesday with Mr. and Mrs. Marvin Tollett was their grandson, Zachary Leif, son of Mr. and Mrs. Burk Tollett of Spade.

Mrs. Mildred Miller of Lubbock visited during the Thanksgiving holidays with her son and family, Mr. and Mrs. Sam Miller.

Mr. and Mrs. Doug Rice of Dallas visited during the Thanksgiving holidays with his mother, Mrs. W.L. Rice, Willie Mae and Mr. and Mrs. Gary Gatewood & family.

Holiday visitors with Rev. and Mrs. Jerry Dodson and boys her parents, Mr. and Mrs. Harry Newberry of Brownwood and friends, Mr. and Mrs. Ed Palmer and family of Rosewell, N.M.

Holiday visitors with Rev. and Ms. Pitts Davis and Sarah were her parents, Mr. and Mrs. Kenneth Chalmers and Douglas Chalmers all of San Antonio and Mr. and Mrs. Jeff White of Austin.

Mrs. Patsy Fisher, Tanya and Shannon spent the Thanksgiving holidays in San Angelo with her parents, Mr. and Mrs. W.M. A Jackson.

Thanksgiving holiday visitors with Mrs. Pauline Hargrove and Mr. and Mrs. Dale Newsom were their sister and aunt, Mr. and Mrs. W.M. M Hahnfeld of Liberty, Mo. on Thanksgiving day they all visited in Lubbock for dinner with Newsom's

daughter Mr. and Mrs. Neil King and family. They Hahnfelds also visited Mr. and Mrs. Jim Bob Hargrove.

Visiting Mr. and Mrs. John Williams this week was his brother Bob of Quanah.

Mr. and Mrs. John Rickey and Johnathan have recently moved into their home at 306 Boesen.

Mr. and Mrs. Francis Drake of San Bernardino, Calif., and Bob Feltes of Santa Anna, Calif., Mr. and Mrs. L.H. Drake of Tullia and Mr. and Mrs. Harvey Frick of Lubbock were recent visitors with their brother, Mr. and Mrs. Bob Drake.

Mrs. Verna Ingle, and Susan Baker, Brooke and Breanne were in Snyder during the weekend to visit relatives and to attend the bridal shower for Verna's niece, Janna Combest.

Thanksgiving holiday visitors with Mr. and Mrs. Harold Ingle and Mr. and Mrs. Corley Baker and family were their sons and brothers, Mr. and Mrs. Mike Jones of Carrollton and Mr. and Mrs. Clinton Jones of Knox City.

Engagement, Contest Story Is Mailed In

(Editor's note: The following release was mailed from Grand Marais, Mich. to The Bailey County Journal. Although it is surely--and undoubtedly--purely 'tongue-in-cheek' this is the story as it was sent in.)

"Clyde Clangwheedle of Pot-hole Lake, Burt Township, narrowly lost out to Menlo Dewlap of Klondike Creek in the Michigan Upper Peninsula's third annual 'Mr. Superior' contest, held November 17, 1984 at the Marquette Ramada Inn.

"Clangwheedle, son of Clancy Q. and Cloreen Clangwheedle of Herford, Texas, was widely considered a shoe-in for the coveted crown until he lost many points when unable to control an acute attack of goosepimples during the swimsuit competition.

"Undaunted by his unexpected defeat, Clyde called a press conference immediately following the contest to announce his engagement to Miss Modine Gunch of Muleshoe, Texas. Childhood sweethearts, they both played cymbals in the Muleshoe High Mighty 'M' marching band, graduating together in 1953.

"The bride-to-be, daughter of the late Fedders and Farina Gunch of Muleshoe, has set an enviable record as a contest winner for her prospective groom. Modine Gunch has captured the title of 'Miss Muleshoe' for the last 25 consecutive years at Muleshoe's world-renowned annual Rattlesnake Roundup and Desert Rat Barbecue.

"An August, 1985 wedding is planned at the Deaf Smith County Bull Barn in Herford following Mr. Clangwheedle's participation in the nationally noted 'Mr. Beefcake' competition at the annual Deaf Smith County Bull-buster's Ball."

Thanksgiving holiday visitors with Mr. and Mrs. G.C. Ritchie and Mr. and Mrs. Dewayne Phillips and children were their daughter and sister, Mr. and Mrs. Tom Lamphere, Julie and April of Dallas.

Rhonda Merryman of Amarillo visited during the Thanksgiving holidays with her parents and brother, Mr. and Mrs. Bill Merryman and Sam.

Cynthia King was among those who have been ill and in the hospital for a few days last week. Others include E.B. Dick, Tommy King, Pearl Wright, T.W. Fife, Iris Harlin, Lendle McCarty.

Mr. and Mrs. John Williams were in Quanah during the weekend to visit relatives and also their son, Jimmy. Mrs. Estelle Lowe accompanied them and remained there for a longer visit.

Mrs. Lois Burleson of Lamesa and mother of Mrs. Dot Nix, has been in the Methodist Hospital for the past several days. Dot, Ann Gaston and Pam Humphreys have been spending some time there with her.

Mr. and Mrs. Bo Lance and Danya visited during the Thanksgiving holidays in Baird with her parents, M/M Carroll Gillet and family.

SAME POLICIES

NEW DELHI, INDIA -- Prime Minister Rajiv Gandhi, in his first major address since taking over for his slain mother, pledged to pursue her socialist and left-leaning non-aligned policies.

MOST COMMON

NEW YORK -- The most common surgery in America is total hysterectomy, and operations for women in general are much more common than those for men, a survey reported recently.

OLDSMOBILE BUICK CHEVROLET PONTIAC GMC
ROBERT D. GREEN, INC.
2400 W. AMERICAN BLVD. - MULESHOE, TEXAS 79347
— HOME OF THE GREEN MACHINES —
BUS. PH. 806 272-4588
505 762-2772
TERRY YELL
SALESMAN
HOME PH. 806 272-4948

A&M
NEW STORE HOURS
7:30 A.M. till 7:30 P.M.
MONDAY THROUGH SATURDAY

Dr. Jerry D. Gregory
General Practice & Bariatrics
3303 University Ave, Lubbock
806/795-6466 For Appointment
Hours
Mon-Fri - 9am - 4pm
Sat - 8am - 12pm
Dr. Gregory is Now On Staff At Community Hospital Of Lubbock
5301 University Avenue

Enter the Lane® \$30,000 furniture SWEEPSTAKES during our Holiday Preview SALE

now at Poynor's
You'll enjoy great savings during these holidays on a beautiful Action Recliner by Lane. This is the time to make your selection while our stock is complete. We will deliver it in plenty of time for the holiday celebrations.

OFFICIAL ENTRY FORM
LANE FURNITURE SWEEPSTAKES!
PLEASE PRINT
Name _____
Address _____
City _____ State _____ Zip _____
Phone No _____
Dealer _____
Address _____

REG. \$575 **\$399**

No need to take up extra room; this recliner opens to full comfort only inches from the wall. Dynamic modern styling with a padded pillow back.



sale \$349
reg. \$499⁹⁵

A traditional look with tufted back, loose seat cushion, kick pleat skirt.



sale \$299
reg. \$409⁹⁵

Plump seat cushion, deep tufted back, and soft rolled arms for total relaxation.



sale \$329⁹⁵
reg. \$469⁹⁵

Relax here on the deeply tufted pillow back, padded arms, deep seat cushion.

OFFICIAL RULES—NO PURCHASE NECESSARY

- To enter, handprint your name, address, zip code, phone number, dealer name and address on an official entry form and deposit it in the entry box at any participating Lane Furniture dealer. Ohio residents may request an entry form by sending a self-addressed envelope to LANE ENTRY FORM, P.O. Box 3820, Syosset, NY 11775. Requests for entry forms must be received by December 8, 1984. Ohio residents may mail their completed entry forms to LANE FURNITURE SWEEPSTAKES, P.O. Box 3772, Syosset, NY 11775. Enter as often as you wish, but all entries must be deposited or mailed separately by January 1, 1985.
- Winners will be selected in a random drawing from among all entries received. Drawing will be conducted by National Judging Institute, Inc., an independent judging organization whose decisions are final on all matters relating to this sweepstakes. All prizes will be awarded and winners notified by mail.
- Prizes are not transferable and no substitution or cash equivalent is allowed. Illegible, mechanically produced or reproduced entries are automatically void. Not responsible for lost, late or misdirected mail. Winners may be asked to execute an affidavit of eligibility and release. Taxes, if any, are the responsibility of the winner.
- Sweepstakes open to residents of the U.S., except employees and their families of LANE FURNITURE, its affiliate companies, participating furniture dealers, advertising agencies, and Don Jagoda Associates, Inc. Void wherever prohibited, and subject to all federal, state and local laws.
- For a list of major winners, send a stamped, self-addressed envelope to: LANE FURNITURE SWEEPSTAKES WINNERS, P.O. BOX 3810, Syosset, NY 11775.

P O Y N O R ' S
103 Main Street WHITE'S STORES, INC. Muleshoe, Texas

Stocking Stuffers

Ambassador Stocking Stuffers
Boxed Cards
Christmas Wrap - Cards
Williams Bros. Office Supply
322 Main 272-3113