

the Hereford Brand

72nd Year - No. 52 Hereford, Texas, Thursday, Jan. 3, 1974 - 30 Pages

Sugar Beet Banquet Set

"America's No. 1 Intellectual Humorist" will be featured when the Texas-New Mexico Sugar Beet Growers Association holds its annual banquet at the Bull Barn beginning at 7 p.m. on Jan. 12.

All growers will be guests at the banquet, and the general public is invited to attend. Tickets, at \$4 a plate, are available at both banks and the Chamber of Commerce office.

DR. JAMES BLAKELY, the featured speaker, is an associate professor at Wharton Junior College in agricultural chemical technology—a unique program developed at his initiative. His occupations include teaching, traveling, flying, ranching, and speaking.

Born in Rush Springs, Okla., and reared in Duval County, Texas, Dr. Blakely holds the distinction of being the only professional humorist in Texas with a Ph.D. He graduated from Sam Houston State University and earned his M.S. and Ph.D. degrees at the University of Missouri.

He is a member of the official board of the First United Methodist Church of Wharton, is past president of the Rotary Club of Wharton, and is a member of the Wharton C of C.

THE SUGAR Beet Growers annual business meeting has been scheduled for 2 p.m., Jan. 11, in the Community Center, according to James W. Witherspoon, executive secretary.

Jay Boston, association president, sent a letter to growers this week reminding them of the business meeting and banquet, and also urging more sugar beet acreage in 1974. Boston listed the following reasons for planting more beets:

- (1) We have a higher guaranteed price for beets through our contract than any of the other crops we grow in this area.
- (2) The other crops we grow depend mainly on export market, while we only grow approximately one-half of the sugar we use in the United States.
- (3) Sugar beets stand hail better than any other crop.
- (4) According to information we get from all the grower associations, there will be a short sugar crop in 1974. We believe this will mean a higher price for sugar in 1974.
- (5) With our new varieties, we believe we can produce from \$20 to \$50 an acre more on beets.
- (6) We believe the records will show we can grow higher sugar with less water which will mean higher profit per acre.

Daylight Savings
Time Begins
Sunday Morning
Set Clocks
Forward One Hour

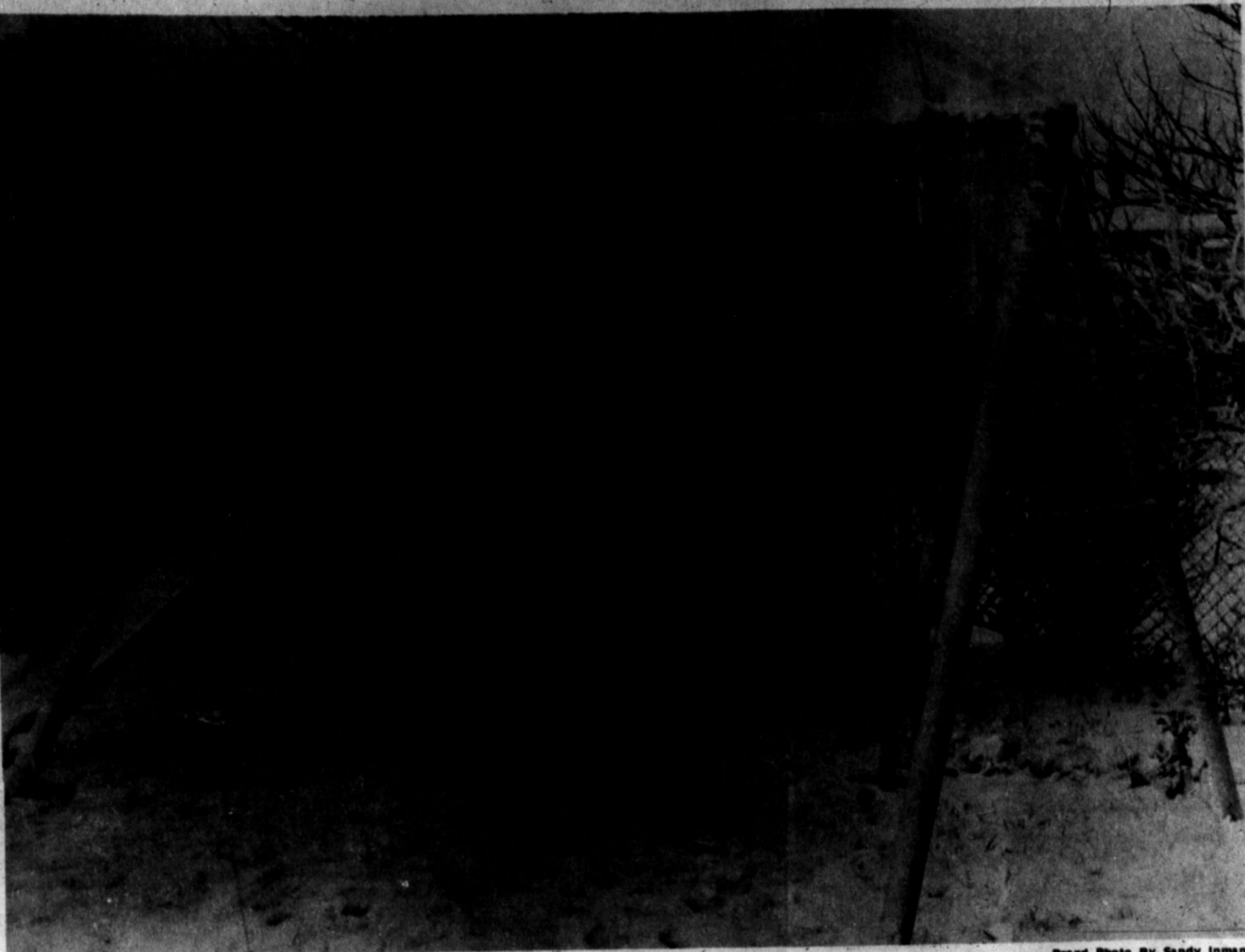

Brand Photo By Sandy Inman

Swingin' In The Snow

O! Man Winter was a week late this year as he ushered in the New Year in Hereford with many snow covered winter scenes like this one at Avenue C and Union. The entire Panhandle area received the cold blast of winter this week as more snow was predicted before the weekend.

Milk Plant Begins Operations Here

By STEVE CONNELLY
Staff Writer

Bright red and white delivery trucks may have already been noticed on the streets of Hereford announcing the opening of this city's newest business, Hereford Pure Milk Co., Inc. which began operating recently.

Open house for the industry, which processes its own milk and milk by-products, is planned later this month or early in February by owner Hugh Kirkland.

"The open house will give people a chance to see what is involved in processing milk," Kirkland commented.

The company presently employs six persons and delivers the dairy products with the two trucks.

Kirkland said deliveries are made to stores and residents in Hereford, but that he plans to deliver to other nearby towns as the business grows.

The plant's facilities could easily produce from 6,000 to 7,000 gallons of milk each day he said. Raw milk is purchased from Associated Milk Producers, Inc. Kirkland explained that almost all milk plants in Texas buy milk from Associated Milk Producers, Inc.

"WE CAME because the people of Hereford deserve a fresh product, and because we feel the local people will support our business," Kirkland said.

He said the circle on the side of the milk cartons which currently displays the "Town Without a Toothache" slogan, will change periodically to promote industry in Hereford.

Kirkland said that about \$100,000 has been invested in the industry for the milk-processing equipment and the building, which is located at U.S. 60 and Main Street.

He said Bill Phipps, state inspector, is required by law to inspect the plants facilities once a month, but that he comes by almost daily.

"He has tried to help us and any time there are questions, he has taken whatever time is required to find the answer," Kirkland said.

KIRKLAND, 44, is a native of Virginia, but has lived in Amarillo since 1959.

He earned a degree from Virginia Tech in 1951 with a major in dairy products. He served two years in the Army during the Korean War before working for Seal Test Foods as assistant superintendent of the Birmingham, Ala. plant.

He left Alabama in 1959 to work for Seal Test in Amarillo as superintendent.

Kirkland is president of the Hereford Pure Milk Co., Inc., with Dr. C.J. Lambert of Dallas as vice-president; and his wife, Mildred, as secretary-treasurer.

The Kirklands have one 10 year-old son, Timothy.

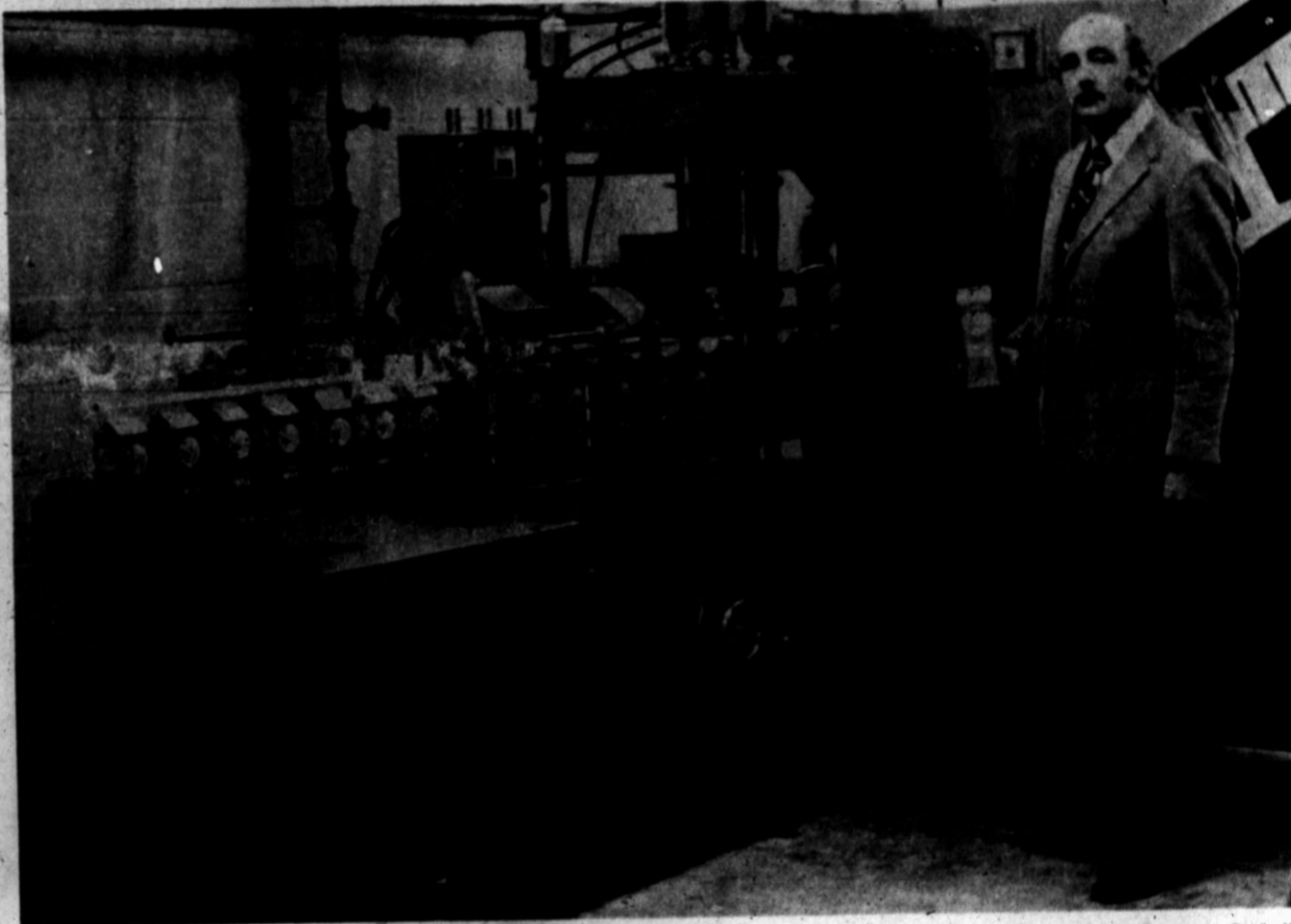

Brand Photo By Steve Connelly

Milk Plant Opens

The Seal-O-Matic machine, which fills the cartons with milk and seals them, is part of the almost \$100,000 investment made in Hereford's newest industry, Hereford Pure Milk Co., Inc. Hugh Kirkland, owner, displays one of the cartons after it has been processed by the machine.

Year-End Review Shows News Highlights

By SUE COLEMAN
Brand Staff

A year-end review of the news highlights indicates an active past year for Hereford.

The 75th Diamond Jubilee Anniversary Celebration here during August was the major news event in the city during the past year. However, stories relating to the beef price freeze, fuel shortage, football team and industrial and economic growth also played major roles in the news during the year.

Highlights of Hereford from the first half of 1973 appeared in Sunday's Brand and the following is a summary account of the news highlights during the months July-December of 1973.

JULY

Jim Hale took office as president when Hereford Lions Club installed new officers for the year. The wheat harvest in Deaf Smith County was pronounced the 'most productive' in years, up as much as 50 per cent over the previous year. Building permits for the past month were placed at \$1,081,400, including new school additions and buildings in a shopping center on West Park Ave.

A market news office was opened in Hereford, it was announced by John White, Texas Agriculture Commissioner as area vegetable crops began to hit the market. The first annual Hereford Junior Olympic Preliminary Track Meet was held with 250 entrants, and three West Texas AAU division records were broken; Deaf Smith Chamber of Commerce sponsored the event.

CITY Commissioners approved leasing to county 4-H Clubs a tract of city land just southwest of town for use as motorcycle trails, with supervised riding specified. Flag-waving, marching, music, food and oratory with Americanism as its topic made up a July 4th celebration for Hereford Residents in Dameron Park; State Rep. Bill Clayton was the speaker.

Holes-in-one became almost ordinary at John Pitman Municipal Golf Course as Glen Bilbrey sunk the third of his career and Earl Springer his second, shortly after Bub Sparks rang up a second and Mike McWhorter his first. A new firm, Grain Handling Corp., located in Hereford with Wister Clevenger as manager.

STATISTICS of the Texas Civic Judicial Council showed the number of cases filed in district court in this county during 1972 down 4 per cent from the year before. Bank deposits were up substantially over the second quarter of 1972, Hereford banks reported at the summer bank call.

County Commissioners set the county tax rate the same as the past year in a session that saw the resignation of Charles Eppler as county road superintendent. Jimmy Jenko was elected commander of the local American Legion post. Good rains fell over the county with 1.1 inches recorded in the city, more in Dawn and Easter communities.

OPENING of a milk processing and distributing plant, Hereford Pure Milk Co., in the near future was announced. Water usage increased sharply in the city, to almost 123 million gallons, with generally warm, dry weather. A

contract was awarded for \$350,182 to construct a library building for the county.

Luis R. Garcia of Lubbock was found guilty of the murder of his wife on a street in west Hereford, and sentenced to five years' imprisonment after a four-day trial in district court here. School board members approved sale of a \$150,000 unused bond issue as a move toward construction of a new elementary school building.

SANDY CAISON, Miss Hereford 1973, won her division of the talent contest in the Miss Texas pageant events at Fort Worth, representing this city. Another Hereford girl, Sherry White, who was Miss Hereford 1972 and Miss Lubbock 1973, was in-top spot in her talent division and swim suit division.

Sheriff's deputies were given a pay raise in the form of a clothing allowance from County Commissioners, but Sheriff Travis McPherson asked for more. Hereford Whiteface gridders were rated a "building" team for the 1973 race.

AUGUST

Eugene Suttle broke a state record and won the rocking chair marathon sponsored by Hereford Jaycees as a preliminary to the city's Diamond Jubilee celebration, rocking 91 hours and 21 minutes to beat a field of 52; runner-up Larry Driver also passed the previous state record with 86 hours.

Jack W. Watson, employe of a construction firm erecting power lines for Deaf Smith County Rural Electric Co-op, was killed when he came in contact with a high voltage power line at work west of Hereford. Announcement was made that a

statewide food stamp program would become effective in this county in the fall, replacing a county-administered program.

Jubilee preparations picked up speed during the month, with a queen contest, oldtime style show, cleanup campaign, contests and promenades stirring interest. The Armour meat packing plant here shut down for a short time as the government price freeze on beef forced a sharp reduction in the company's processing operations over the nation.

Building permits for the past month were reported at \$467,550, including \$350,000 for the new county library; this brought the 1973 total of \$2,736,595, almost as much as the amount for the entire year 1972.

WEEKEND activity of city police and sheriff's deputies resulted in 15 arrests in the city on marijuana violation charges. District 4-AAAA grid coaches were entertained at a dinner attended by about 100 fans who heard the coaches' pre-season evaluation for their 1973 teams.

A dress and hair code for Hereford Public Schools was adopted by the school board as a \$3.6 million budget for the coming term was approved.

A train-truck collision east of Dawn caused the death of George W. Farmer, an Amasillo man who was driving the truck. Hereford Whitefaces were picked to finish fifth in District 4-AAAA, with Lubbock Monterey predicted to win the crown, by the Harris Rating System in its Texas Schoolboy grid forecast for the season.

MERCHANDISE valued at more than \$1,000 was taken from a window in a burglary of Cowan Jewelry Store. A

Local Opinions Vary About Oil Shortage

By KERRIE WOMBLE
Staff Writer

Hereford area residents are apparently very varied in their opinion of the nationwide oil and fuel shortage and whether it is a real problem or not.

In a random poll of several Hereford residents, opinions given suggested the oil shortage "will probably get worse" while others felt "it's not an urgent problem."

Each of the persons questioned were asked if they believed the oil shortage was a real problem in the United States, and if so, how urgent?

RAY FRYE, American Dusting Company: "I think it's real to a certain extent, yet not an urgent problem. I have

heard reports from reliable sources that say that at this time all the major refineries have full storages of oil.

"Of course, the Arab oil situation has depleted the U.S. supply somewhat," Frye said. "However, I think Americans have rallied and decreased their use of electricity and fuels more than was expected.

"The shortage is not as bad as we have been led to believe. We certainly have a shortage. But I feel that the long-range plans of our government of importing foreign oil have kept America's natural resources safe," Frye added.

"The shortage is causing some of the ecologists to back up."

"These conservationists have gone too far the other way in some matters and the crisis is giving us a chance to make some needed developments."

RAY SIMPSON, Conoco Oil Jobber: "I think people are becoming more aware of the reality of the oil shortage. Up until recent times, people didn't believe that the shortage was real. Some people still don't.

"The situation is pretty urgent and will probably get worse before it gets better. It can become a really bad problem if some measures aren't taken," Simpson said.

"I think the conflicting reports concerning the shortage have people confused and not knowing what to believe. A hard-core education in publicity is necessary for the oil companies to help the public understand. Americans are cooperating quite well. However I think we have a long haul ahead."

CHARLES DUVAL, Northwest Elementary School: "I'm assuming the shortage is real. The school is cutting down in several areas.

"We've disconnected over 100 lightbulbs in our halls and

asked our teachers to car pool," Duvall said. "Of course the car pooling is not mandatory but I feel that many will comply. We have also adopted a policy of turning out all lights when they are not in use.

"Personally, as to the urgency of the problem, you can't believe everything you read or hear," Duvall added. "I think the amount of oil from overseas could have kept gas stations open.

"I'm for doing my part. I'd rather go without a vacation than have some family up north be cold because there isn't enough gas for heat."

THE REV. Eugene Brink, First Christian Church: "I believe it's real. I expect it will be with us for a long time. "I think the situation is pretty urgent," he said. "The gas stations are probably not opposed to closing Sunday. I'm glad they can get a day off."

FRANK ZINSER, farmer: "I feel there is truly a shortage of refined oil products, because there certainly is a lower availability of gas products. I'm not sure why there is a shortage. But I am not convinced that the shortage is caused by a lack of refineries or industry.

"It is not as urgent in this area," Zinser said, "I feel the East Coast may really be in trouble shortly because they depend more on imported fuels."

L. C. HEWITT, farmer: "I don't think it's quite as bad as the media reports, but it could get that way in the future if things continue like they have."

NITA HOFFMAN, Hereford Cab Company: "I believe it's real. We depended on other countries too much and should never do it again."

Keepsake



VISTA

KESTER'S JEWELRY

Across from the Post Office in Downtown Hereford

Marine Begins Special Course

Marine PFC Joe B. Robertson, son of Mr. and Mrs. Weldon Roberson of 219 Beach, Hereford, has begun basic electronics training at the Marine Corps Base at Twentynine Palms, Calif.

When he completes this school he will be assigned to specialized training in communications-electronics.

Hospital Notes

PATIENTS IN HOSPITAL

Manuel Serrano, 116 Ave. A; Mrs. Ellen Robbs, Route 2; Mrs. Alma Estep, Friona; Mrs. Exie Mays, 322 Ave. E; Leslie Lightfoot, 222 Ave. A.

Mrs. Frances Lopez, 329 W. Second; Mrs. Jessie Jackson, Dimmitt; P.L. Burrell, 206 Ave. K; Belton Bryant, 415 Ave. J; Mrs. Dolores Christi, Summerfield; Clarence Smith, 229 Ave. C.

Mrs. Glenda Tiner, Spur; James Pankey, K-Bar Motel; Mrs. R.A. Fullwood, 206 McKinley; Wade Lewis, Route 1; Walter Hodges, 402 W. Park Ave.

Edwin Stewart, 707 Blevins; Mrs. Jewel May, Route 2; Mrs.

Gwenn Davis, 300 Star; Mrs. G.F. Muller, 221 Ave. D; Edgar Blakney, Route 3.

Howard Gore, 148 Centre; John B. True, Canyon; Mrs. Gertrude Probasco, 510 Sampson; Mrs. David Farmer, 834 Blevins; Mrs. Thomas Lange, Grand E. Trailer Park.

Mrs. Juanita Del Toro, P.O. Box 1826.

PATIENTS DISMISSED

Christina Ramirez, Mrs. Eliday Alonzo, Mrs. D.A. Nolen, Mrs. E.M. Green, December 31.

Ralph A. Yerby, Mrs. Maria Y. Villalavos, Mrs. Shirley Steward, Lauralyn Jordan, December 30.

Terrill Elliott, Farris A. Kromer, Roy Lee Campbell, Gabriel Martinez, December 29.

Mrs. Lora E. Sparkman, Walter J. Frost, December 28.



Troop Donates Funds

Scott Ward, center, and a senior patrol leader of Scout Troop 50 in Hereford is pictured after presenting money from the troop to two area organizations. Receiving the funds were Mrs. Viola Williams, board of directors of Girlstown, and Robert Viegeli, who is on the board of directors of Boys Ranch.

Briscoe Gives Grant

Governor Dolph Briscoe has awarded a grant of \$9,728 to the Palo Verde Regional Planning Commission at Amarillo for the organization of a regional law enforcement civil disorder project.

The money will come from the Governor's Office, Criminal Justice Division. CJD administers the state's block grant from the Law Enforcement Assistance Administration under the Crime Control Act of 1973.

Funding will provide for the purchase of riot-control

Look Who's New

Mr. and Mrs. Andres Del Toro Jr. are the parents of a daughter, Cynthia, born December 31. She weighed 7 lbs. 12 oz.

Mr. and Mrs. David Gene Farmer are the parents of a daughter, Stephanie Melissa, born December 31. She weighed 6 lbs. 6 1/2 oz.

Mr. and Mrs. Thomas Edward Lange are the parents of a daughter, Kerri Dawn, born December 31. She weighed 6 lbs. 12 oz.

Mr. and Mrs. Manuel Alonzo are the parents of a son, Dionicio, born December 30. He weighed 7 lbs. 10 oz.

Crisis Program Meets Tonight

Hereford's chapter of the Suicide Prevention Crisis Intervention (SPCI) organization will hold a monthly meeting at 8 p.m. today at the Mental Health-Mental Retardation building at 625 East First Street.

The assembly is open to the public and will formalize the screening of SPCI Hotline volunteers. The Hotline is a telephone service designed to counsel suicide candidates. Hotline counselors will be carefully selected and receive training before making phones in mid-February.

Bill Johnson, chairman of the local SPCI, will preside over the meeting and recruitment of interested citizens.

Packed with Values! Downtown and Sugarland Mall.

WHITE Sale

Anthony's
C. R. ANTHONY CO.

CHEVILLE-TYPE PANELS
63" or 81" Length
Reg. 2.10
1.66

For livelier windows, choose our extra-wide chenille-type panel. They come ready to hang. In popular colors of ivory, gold, and green.

SHEETS BY DAN RIVER
Fortrell® Polyester and Cotton
Inspiration is what you'll have when you choose these Dan River® percale, no-iron sheets and pillow cases. A beautiful floral pattern in gold, pink, and blue.

TWIN	3.07	2/\$6	QUEEN	5.57	2/\$11.
FULL	4.07	2/\$8	KING	7.57	2/\$15.

CASES
42x36 \$2.77 pr. 42x46 \$3.17 pr.

BEAUTIFUL BEDSPREADS \$10.

Special group of several assorted machine washable bedspreads. Comes in white, old gold, and avocado.

A-1 PILLOWS 2/34
21"x27" Pillowtex® pillows in striped ticking fabric. 100% polyester filled. 30 oz.—so they're easily cared for and so comfortable for sleeping.

DEBUT PILLOWS 2/38
Pillowtex® gives you a wonderful value on an always-needed item. This super soft Dacron® polyester filled pillow. Fully machine washable and dryable.

BATH TOWEL ENSEMBLE
Pansy embroidered sheared bath towel ensemble. Are sure to brighten up and highlight any bath decor. Comes in light yellow, green, beige, and blue.

BATH	HAND	WASH
127	77	37

3 Pc. set 125

We formulated our special

Liquid Wheat Pasture Supplement 16

to hold down consumption

so they'll eat just enough of it to fight wheat pasture poisoning.

It's high in magnesium — to help prevent wheat pasture poisoning due to grass tetany. Low in protein — just enough to regulate consumption. And this special wheat pasture formula has all the vitamins and sequestered trace minerals needed for good health, and sugar and carbohydrates for energy.

Like all the products from T-E's complete liquid feed supplement program, T-E Liquid Wheat Pasture Supplement 16 is self-rationing, convenient, labor-saving and economical.

T-E LIQUID FEED SUPPLEMENT

TAYLOR-EVANS FARM STORE
Sugar Beet Road

Get with the program... the T-E Liquid Feed Supplement Program



Lesly Makes Dean's List

Thomas Luther Lesly of Hereford appears on the Dean's List, honoring academic achievement during fall quarter 1973, at Western State College of Colorado, Gunnison.

To qualify for the honor, Lesly, a senior at WSC, had to carry a full load and compile an average of 3.7 or better. Appearing on the Dean's List means that he ranked in the top 5 per cent of the 3,192 students attending WSC last fall.

The Hereford Brand

Published Every Thursday
MEMBER National Editorial Association
Member Associated Press

at 128 W. Fourth
Hereford, Deaf Smith County,
Texas, 79045

THE HEREFORD BRAND, INC.
Entered as second class matter at the Post Office in Hereford, Texas under the act of March 30, 1879. Second-class postage paid at Hereford, Texas. Any erroneous reflections upon the character, standing or reputation of any person, firm or corporation, which may appear in the columns of this paper, will be gladly corrected upon due notice of same being given to the editor personally at the office. Subscription Rates: Zone 1, \$3.00 per year; Zone 2 and above, \$4.50 per year. With Classified Advertising Rates: 8 cents per word first insertion 80 cents minimum; 4 cents per word additional insertion.

The Sunday Brand, both papers, Zone 1, \$6.75 per year; Zone 2, \$7.50 per year. Carrier delivery, \$1.00 per month. Single copies 10 cents each.

O.G. Nleman Publisher
Don Richards News Editor
Eve Coleman Women's Editor
Lynn Briandline Advertising Manager

CIRCULATION 364,200

Receives Silver Wings



Second Lieutenant Terry R. Lee, son of Mr. and Mrs. Rex Lee of 304 Centre St., Hereford, has been awarded his silver wings at Vance AFB, Okla., upon graduation with honors from U.S. Air Force pilot training.

Lieutenant Lee is being assigned to Charleston AFB, S.C., where he will fly the C-141 Starlifter.

The lieutenant graduated in 1972 upon graduation from Officer Training School.

A 1968 graduate of Hereford High School, he received his B.S. degree in mathematics from the University of Texas in Arlington. He is a member of Delta Tau Delta.

The lieutenant's wife, Linda, is the daughter of retired USAF Colonel and Mrs. William L. Gibbons of 2104 Lakeside Drive, Arlington.

Granted Command

U.S. Air Force Lieutenant Colonel Hubert O. Spraberry, son of Mr. and Mrs. Hub Spraberry of 605 W. Belsler, Dimmitt, has assumed command of the 321st Security Police Group at Grand Forks AFB, N.D.

Colonel Spraberry is a member of the Strategic Air Command. Prior to this assignment, he was deputy commander of the 448th Strategic Missile Squadron.

A 1946 graduate of Witharal (Tex.) High School, he received his B.S. degree from Texas Tech where he was commissioned in 1952 through the Air Force Reserve Officers Training Corps program.

The colonel's wife, Teddy, is the daughter of Mr. and Mrs. C.H. Billins, 205 53rd St., Lubbock.

Thanks For Girlstown Gifts Voiced

Gifts from Hereford area residents helped make a merry Christmas for residents of Girlstown both at Whiteface and Borger, Viola Williams, a Girlstown board member, reports. Mrs. Williams was a guest at Christmas parties on both campuses of the girls' residence home.

She expressed appreciation for all the contributions by Hereford merchants, clubs, churches and individuals who gave cash or gift items for the girls of all ages who make their home in one of the residences.

Mrs. Williams has for a number of years, during and before her tenure as a director for Girlstown, collected gifts here. She takes many of them to the homes in her own car as she makes frequent visits.

In addition, numerous Hereford clubs and church groups make a custom of giving to Girlstown at Christmastime. Several of the girls were guests in Mrs. Williams' home during the holidays.

Marnells Have New Grandbaby

Mr. and Mrs. F.A. Marnell of 124 Aspen are the proud maternal grandparents of a New Year's baby, born to Mr. and Mrs. Larry Minks of Elkhart, Ind.

Mandy Minks, 7 pounds and 14 ounces, was born at 12:06 a.m. Jan. 1 and enjoyed the honor of being the first 1974 child in that region.

Mandy's great-grandmother is the local resident, Mrs. Lucille Wilhelm of 407 East Third. Her paternal grandparents are Mr. and Mrs. Norman Minks of Saguache, Colo.

GIBSON'S DISCOUNT CENTER

PRICES EFFECTIVE Thursday Jan. 3 through Saturday Jan. 5

Waffle Weave DISH CLOTH SALE
100% Cotton Retail 20¢ **9¢**

Full Cushion Athletic STRETCH SOCKS SALE
with comfort top Full cushion foot Guaranteed for 5 years 85% Cotton 15% Nylon white only! Size 6-8 1/2 9-11 10-13 **57¢**

LIMITED SUPPLY!

Hampton Court Sheared Terry Jacquard or Velvet Solid Color **BATH TOWELS**

BATH	Retail 2"	Sale 97¢
HAND	1 1/2"	77¢
WASH	7 1/2"	39¢

Men's 100% Cotton Pkg of 3 T-SHIRTS SALE
Shrinkage Controlled Reinforced Neck-Non Ravel Seams Retail 13" **\$2.88**

DOOR LENGTH MIRRORS SALE
By Hamilton Reg. \$7.57 **\$5.27**

GIBSON'S 3 LB. CAN of FOLGER'S COFFEE ALL GRINDS SPECIAL PRICE WITH THIS COUPON **\$2.71**

GOOD THRU 1-5-74

JANUARY White SALE

EXTENDED "3" MORE BIG DAYS
Shop Now at our After Christmas Sale from 9:00 to 9:00

SNOW SHOVEL NO. P18S **ONLY \$1.99**

MATTRESS COVERS Health Protection For Allergies stain-proof-dust proof water repellent Retail 11" **89¢**

Wafmcrest by Northern HEATING PAD Guaranteed 2 years 4 position switch indicator light washable cover waterproof Pad Retail 15" **\$3.88**

Women's 100% Nylon Satinette PANTIES Nylon Seamed For longer wear Asst colors Retail 11" **59¢ PR.**

Women's 100% Nylon Tricot Kodel Fiberfill BRA Asst. Colors Retail 11" **97¢**

PLACE MATS Asst Patterns Color Fast Retail 11" **69¢**

SHEETS 50% Polyester 50% Cotton (Happy Time)

Full 81x104 Flat or Fitted 4"	\$3.77
Twin 72x104 Flat or Fitted 3"	\$2.77
Queen 90x115 Flat or Fitted 6"	\$5.44
King 108x115 Flat or Fitted 8"	\$6.44
42x36 Standard Cases 12"	\$2.44
42x46 King Cases 13"	\$2.77

Playtex NURSER KIT **\$5.37**

Pkg of 2 Boy's BRIEFS Permanent Press 50% Polyester 50% Cotton SALE Retail 12" **\$1.57**

No. 321410 INSTANT HEAT HEATER 1650 Watt By McCrow Edison NOW Reg. 18" **\$15.97**

CURL FREE Natural Curl Relaxer **\$1.87**

Curity SUPERSOFT PUFFS 260's or 100's Your Choice **47¢**

CREST TOOTHPASTE Large 5-oz. Reg. or Mint **53¢**

LISTERINE MOUTH WASH 14-oz. Size ONLY **87¢**

Year-End Review Shows News Highlights

Continued From Page 1

past president of the Rotary Club of Hereford, England, Bert Weston, was a visitor with Hereford Rotary Club. Enrollment for the fall term in Hereford Public Schools began Aug. 20.

The Hereford Brand issued a 140-page Diamond Jubilee edition, largest in its history, with stories and pictures recalling the city's history as well as the program for Jubilee Week which began Aug. 25. A mammoth parade with Gov. Dolph Briscoe as marshal and Betty Hodges, Jubilee Queen, in the honor spot, formally opened Hereford's 75th birthday celebration.

Deaf Smith General Hospital directors approved a \$1,445,000 budget for the coming year, about \$400,000 more than the previous year. The Rev. Roger Knapp came from Tulsa to be interim pastor of the Presbyterian Church, succeeding the late Rev. Russell Wingert.

HEREFORD RIDERS Club annual rodeo drew about 2,000 spectators each performance of a three-night stand. County commissioners adopted a budget of \$1,162,437, calling for county tax increase of 5 cents per \$100 assessed valuation, with the assessment remaining at 22 percent of value.

Crowds turned out for weeklong Jubilee events to end the month, beginning with outdoor religious services, including Ladies Day, appearances of political bigwigs and burial of a time capsule, and ending with a historical pageant presented four nights.

SEPTEMBER

Hereford High Rodeo Club was host to about 200 entrants from a tri-state area in an approved three-day meet. The annual New Teachers banquet sponsored by the Chamber of Commerce was held, with some 65 additions to the school system's faculty introduced.

Hereford Community Concert Association held its annual membership drive with Mrs. Richard Ottesen and Mrs. Paul Scott as co-chairmen. Diana Torres was crowned Fiesta Queen at the Mexican Independence Day celebration in the Bull Barn.

WHITEFACE gridders defeated Pampa Harvesters 12-0 in their first game of the 1973 season. Police Capt. Ray Morgan began his term as president of Hereford Peace Officers Association. Holly Sugar officials, meeting here with directors of Texas-New Mexico Sugar Beet Growers Association, announced that a raise in the price of sugar would mean increased prices for 1973 sugar beet crops.

Benny Womble, Veterans' Service Officer in this county, was elected director of the Lubbock region of the Veterans' County Service Association of Texas when he attended a state convention in Dallas. Roland Saul began duties as assistant Criminal District Attorney.

Community Education classes offered through Hereford High School in cooperation with Amarillo College began, including vocational courses and varied other subjects. Mrs. Bill C. Thompson, who with her husband owned and operated Dickies Restaurant, died after a long illness.

DEAF Smith County Feedyards Inc. announced intent to purchase all capital stock of XIT Feedyards of Dalhart. Hereford Whitefaces defeated Palo Duro Dons of Amarillo, 37-7. City Commission approved a franchise for Pioneer Natural Gas Co. but postponed action for a requested gas rate adjustment, and hired Melba Richards as manager of the Community Center.

A \$38,000 bond election for resurfacing of the track at Whiteface Stadium was called by the school board. First load of milo for the year was brought in by Ray Wilhelm, southeast of Hereford. Deaf Smith General Hospital board of directors voted to establish an intensive care unit in the hospital.

Jimmie Allred was elected president of Kings Manor Founders Association at the group's annual dinner at the Manor. Annual County Crops Tour was held, with stops on the farms of Chester Wiggins, Claude McGowen Jr., Charles Schlabs, Clark Andrews, Bobby Veigel and Bill Cheek.

HOLLY Sugar plant opened its full operations with more than 20,000 tons of freshly harvested beets already at the plant in an early beginning of the season's work. HHS football team continued winning, squeezing by Borger 15-12 and downing the Canyon Eagles 28-11. Lynn Brisendine, advertising manager of the Lamesa Press-Reporter, was named to the same post on the Hereford Brand, returning to the local staff where he had formerly been an ad salesman.

OCTOBER

The new Whiteface Kiwanis Club installed officers, headed by Cecil Boyer as president. The Rev. Bernard McGorry, former assistant pastor of St. Anthony's Catholic Church, came from New York as pastor of the church to succeed the Rev. Boniface Riedmann, transferred to Lumberton, N.C.

Voters approved a \$38,000 bond issue to resurface the running track at Whiteface Stadium. Rebuilding the intersection of Highway 385 and Park Avenue to construct additional turning lanes, was one of the projects approved for the year by the State Highway Department.

SCATTERED rains temporarily halted the harvest of sugar beets and other field crops in a season generally favorable for harvest. Hereford Jaycees and Jaycee-Ettes were hosts to the convention of Area I-A, with some 200 delegates present.

Chris Marnell and Roger Sanders were named 4-H Gold Star girl and boy for this county, at a dinner climaxing observance of 4-H Week. Carlos Zarazua of Dimmitt, em-

ploye of Armour and Co., was killed in the collision of the car he was driving and a truck at a county road intersection about five miles southwest of Hereford.

The fall meeting of Panhandle Area Beta Sigma Phi groups was held here, with the four Hereford chapters as hostess to more than a hundred visitors. Operator of a service station and car-sales firm, Kelly Coplin died here. City Commission denied a rate adjustment request of Pioneer Gas Co.

MORE THAN 60 rescue workers spent four hours freeing Guy E. Carroll of Caldwell, Santa Fe Railway employe, when he was pinned in wreckage of a derailed crane near the railroad overpass on East U.S. 60; his injuries resulted in Caldwell's death late in December.

A pay increase for five per cent for all Deaf Smith General Hospital employes was voted by the board of directors who approved an increase in room rates at the same time. County Judge H. C. Williams was named director for the 1974 spelling bee in Deaf Smith County.

FIRST conference game for Hereford Whitefaces in the District 4-AAAA grid race was won with a 26-10 score over Monterey of Lubbock, climax of the HHS homecoming, following a 21-2 victory over Amarillo High. Banks in the city set a new record high for deposits with \$63,514,467 reported in the October bank call.

For the 14th consecutive year, the HHS Whiteface band was given top rating in regional UIL contests held at Canyon. Keith Winkler of Hereford was elected president of Range 2, United Sheriffs Poses and Riding Clubs, and Sandee Finley received the queen title at an area meeting here.

Andrew Kerahan, Ray Seale, Arturo Gonzales and Galvin Goodin were elected directors of Deaf Smith Chamber of Commerce by members' ballots. Whitefaces downed Borger 28-16 to take the lead in the 4-AAAA grid race. Kevin Douglas, 4-H club member in this county, exhibited the reserve champion Angus steer in the Junior Livestock Show of the Dallas State Fair.

NOVEMBER

Farmers in Deaf Smith County and over the entire area were hit hard by fuel allocations in a federal program to meet the energy crisis, with harvest of cotton, beets and feed

grains in full swing and the threat of no fuel for harvest machinery.

An autograph party was held at the Christian Book Store to formally present the new Deaf Smith Country Cookbook, written by Marjorie Ford of Hereford in collaboration with Mary Faulk Kooch of Austin. Lee Newman, road maintenance foreman with the Texas Highway Department here, retired after 35 years of service with the department.

BUILDING permits rose past the \$3 million mark, more than the total for 1972, with almost \$200,000 in October permits. Hereford defeated Lubbock Coronado gridders 20-0 to preserve its perfect 4-AAAA record. Two women were seriously injured in as many highway accidents; Dorothy Ott in a head-on collision on Highway 385 just south of the city and Lily Muller in a truck-car smashup east Highway 60.

City Commission approved a city employe retirement system. The federal Oil & Gas Office announced an easing of restrictions on fuel for farm use, relieving Deaf Smith County farmers of a crisis in fuel for harvesting. One of the city's oldest independent businesses, Piggly Wiggly Grocery, was sold by Gaylord Newell to DMD, Inc.

IN A light voter turnout, county voters followed a statewide trend in deciding on the fate of nine proposed Texas constitutional amendments, opposing annual sessions of the state legislature and a pay raise for legislators, the amendment attracting the most interest.

First sale of Deaf Smith County cotton in the 1973 crop was produced by Ronnie Andrews, south of Hereford. The undefeated Hereford Whitefaces suffered an upset when Snyder took a 28-7 victory on the Herd's home field. Rex Easterwood was elected board chairman for Hereford Day Care Center at the annual meeting of directors.

John C. Trotter, 64-year-old Hereford man, was charged with murder after a shooting in which Alfonso Diaz was killed. Mrs. L. W. Norvell was named director of Texas Division 1, Daughters of American Revolution; she is currently regent of the local DAR Chapter.

WHITEFACE eagles opened their season with a win over Canyon Eagles here. Roy Faubion, vice president of Deaf Smith County Chamber of Commerce, was named to succeed Jim Konkright as president for 1974. The

District 4-AAAA grid title was won by Hereford with a 28-7 defeat of Lubbock High; Teri Reinauer was crowned Football Queen at a pep rally before the game.

Steve Graham, youth director in First Baptist Church since July, 1972, was named associate pastor. A longtime banker in the Panhandle and executive vice president of First National Bank, Pat Malone, died here and was buried in Amarillo, his former home. Whiteface Week was proclaimed in Hereford as Hereford met Caprock of Amarillo in bi-district play, winning 13-7.

NEW OFFICERS were installed, with Les Umstead as president, when former Gov. Preston Smith of Lubbock addressed the Hereford Board of Realtors. Whiteface coach Larry Dippel was chosen coach of the year, runningback James Harris as player of the year and wingback Dave Charest as sophomore of the year, by sports writers of District 4-AAAA; Armando Gonzalez, Jim Marsh, David Crume and Wayne Schumacher also won places on the all-district team picked by coaches.

A Natural Resources Seminar sponsored by the county Water Association in cooperation with Water, Inc. was held in the Bull Barn. Whiteface Stadium was the site of the Vega-Hale Center bi-district Class A grid game which Vega won, 37-0.

DECEMBER

The newly-completed intensive care unit opened in Deaf Smith General Hospital with Rose Ann Smith as ICU supervisor. HHS gridders lost their bid to advance to quarterfinals in state playoffs, as they managed only a 7-7 tie with El Paso Coronado and lost on penetrations, 5-3, but were happy with a record of 10 consecutive wins by a team which had been picked for a low spot in district play.

Deaf Smith County's income from agriculture was set at more than \$168 million, topping the 1972 total by \$52 million, in figures compiled by the county extension agents' office with harvest virtually completed. Joe B. Davis, retired dean of Amarillo College, died at his home in Kings Manor here.

Up to three inches of snow in parts of the county brought

See TOP NEWS STORIES Page 5

JANUARY CLEARANCE SALE

GASTON'S SUGARLAND

<p>MEN'S DEPARTMENT</p> <p>130 Double Knit-100% Polyester MEN'S SUITS \$98</p> <p>95 DOUBLE KNIT 100 POLYESTER MEN'S SPORT COATS \$68</p> <p>95 DOUBLE KNIT 100% POLYESTER YOUNG MEN'S SUITS \$59</p> <p>75 DOUBLE KNIT 100% POLYESTER YOUNG MEN'S SPORT COATS \$39</p> <p>28 DOUBLE KNIT MEN'S DRESS & SPORT PANTS \$15</p> <p>16 DRESS & SPORT Long Sleeve SHIRTS \$12</p> <p>12 DRESS & SPORT, Short Sleeve SHIRTS \$8</p> <p>ENTIRE STOCK MEN'S DOUBLE KNIT JUMPSUITS \$12</p> <p>ENTIRE STOCK MEN'S TRICOT & DACRON & COTTON PAJAMAS & ROBES 1/2 PRICE \$8.50 TIES NOW \$5.00</p> <p>BOY'S DEPT.</p> <p>FIRST TIME SPECIAL BOY'S WINTER & SPORT COATS 20% OFF</p> <p>BOY'S PANTS \$3.99-\$4.99</p> <p>BOY'S SHIRTS \$4.99</p>	<p>SHOE DEPARTMENT</p> <p>REPEAT of a SELLOUT Just received new stock</p> <p>Black Pat. Blue Pat. White Pat. Black Suede Red Pat. Brown Suede</p> <p>\$13.90</p> <p>ENTIRE STOCK Junior & Misses</p> <p>CLOGS HEELS SANDALS \$15.90</p> <p>MANY STYLES BETTER DRESS & PANT SHOES \$19.90 While they last Now Styles</p> <p>MEN'S SHOES \$13.90</p> <p>JEANERY 2000 PAIR</p> <p>CUFFERS & JEANS \$9.90 Denims Knits Wovens 26-38 Waist 5-13 Junior sizes VALUES TO \$22.00</p> <p>EVERY PANT - OVER 2000 PAIR</p>	<p>LADIES READY-TO-WEAR</p> <p>Compare at 140 100% Polyester</p> <p>PANT SUITS \$19.90 OVER 300 PIECES POLYESTER</p> <p>SEPARATES</p> <p>Blazers Blouses Vests Pants Shirt Jacks</p> <p>1/3 - 1/4 OFF</p> <p>LADIES BETTER KNIT</p> <p>PANT SUITS \$39.90</p> <p>GREAT GROUP LADIES</p> <p>PANT COATS \$35.00</p> <p>JUNIOR DEPARTMENT</p> <p>OVER 200 PIECES JUNIOR</p> <p>SEPARATES</p> <p>Blazers Shirt Jacks Sweaters Blouses Pants</p> <p>1/3 - 1/4 OFF</p> <p>DOWNTOWN Ready to Wear</p> <p>LARGE RACK</p> <p>DRESSES 1/2 PRICE</p> <p>FAMOUS BRANDS POLYESTER</p> <p>SEPARATES</p> <p>Vests Shells Blazers Shirt Jacks Long Skirts</p> <p>1/4 OFF</p>
--	--	--

Boots ★

★ WEST

Tony Lama,
Sanders,
Justin,
Nocona,
Cowtown
and
Acme Boots

Hereford's Finest Selection
of Boots for the Family.

- OPEN -
364-5961
8-6M-S
Hwy. 60 E.

The Hereford Brand, Hereford, Texas, January 3, 1974

On Wall Street

No Recession In Outlook During 1974

BOB HILL
Lentz, Newton & Co.
January is named for the god

Janus who had eyes in the back of his head as well as the front, so that he could see the past as he viewed the future. In looking

back at 1973, I'm not sure our nervous systems could stand another 12 months like those we have just completed.

The tough part about forecasting these days is the variables and uncertainties which can completely cancel out any forecast. Even though the Arab leaders are finding themselves increasingly embarrassed by the embargo and the fact that economic black-mail will inevitably fall, I will assume that the oil embargo against the U.S. will not be lifted until well into 1974, if then.

major factor in labor costs this year. The number of workers under contracts that must be renegotiated in 1974 will be considerably less than it was in 1973, about 8 per cent of the labor force. The major area of concern for 1974 will be labor productivity, which is far more significant than increases in hourly wages. Remember, productivity improves sharply during economic recoveries, but slows dramatically during boom periods.

Satisfy further increases in demands while plants are running at full capacity. Moreover, we should begin seeing a slowdown in the rate of growth of the labor force in 1974. This is why there will probably be more people employed in 1974 than in 1973.

A major economic consequence of the Mideast War is a change in the attitude of Congress toward defense spending. Defense spending should jump sharply throughout calendar 1974. This is good news for defense contractors for two reasons.

First, the Israeli hardware lost in the war will have to be replaced, presumably from U.S. producers. Second, the Administration can now make a strong case

period of time. Such price rises practically guarantee increases in fuel prices and a further push to inflation. Inflation rates in consumer prices will be accelerated as a result of shortages of fuel. This postpones the time when rates of inflation will decline appreciably. The shortage of oil will also weaken the demand for consumer durables, particularly next Spring.

YOU should expect the Dow Jones Industrial Average to establish a base at the 750-800 level because the market has now adequately discounted the economic uncertainties confronting the nation. 1974 will be a rising stock market year for basic industry stocks.

Pickup Fire Turns Out Other Than 'Routine'

By STEVE CONNELLY
Staff Writer
Hereford firemen thought they were reporting to a routine auto fire at 8:46 a.m. Wednesday until they found 30-35 pounds of dynamite in the bed of the burning pickup.

Deaf Smith County Fire Marshal Jay Spain said he spotted the burning pickup on U.S. 385 and warned the driver that the vehicle was in flames.

The Hereford Fire Department also reported to four other fires during the week, none causing serious damage. The Hereford Police Department arrested four men for driving while intoxicated during the week, and five Hereford juveniles were arrested in two separate incidents for allegedly sniffing paint.

MOST ECONOMIST predict a slowdown in the economy and a drop in the Gross National Product during 1974. I believe we will see an increase of 7.8 per cent in the GNP in 1974.

Experts have been making dire predictions about sharply rising demands of labor unions for wage increases in 1974 because of spiralling living costs. Do not expect this to be a

THE DRIVER stopped the pickup at the curb and ran as Hereford firefighting units were called to the scene.

When the units arrived, an acetylene tank in the bed of the pickup exploded, but the fire was quickly extinguished.

Firemen discovered the dynamite in the bed of the unmarked pickup after the flames were extinguished. Blasting caps were discovered in the cab of the vehicle and some of the caps were reported to have exploded during the fire.

An oxygen tank and the dynamite in the bed of the pickup did not explode during the fire.

A dust explosion at Farr Better Feeds injured one man shortly after noon Thursday as a bin was being repaired with a

Top News Stories

Continued From Page 4

the first moisture since mid-October, and a taste of winter to the area. A night fire caused damage estimated at \$100,000 to John Orsborn Buick-Pontiac showroom and parts department in downtown Hereford.

Tom J. Hamlett, Armour Food Company plant manager here, announced plans for a major expansion in the local plant, to be completed in stages over the next six to 12 months.

November building permits in the city were totaled at \$196,300, with the year's total well above 1972.

MERCHANTS and law enforcement agencies cracked down on shoplifters and hot check writers as holiday shopping crowds filled stores. Coach Larry Dippel and ace back James Harris received post-season honors when they were named respectively South Plains coach of the year and on the All-South Plains grid team.

Mrs. Philip Barkley, 72, Campfire Girl executive here for a number of years, died after a long illness. Hereford boxers, who had won their share of bouts in meets over the area, played host to junior gymmen from Amarillo and Canyon and won 11 of 14 matches.

HEREFORD'S United Way drive reached and passed its goal for 1973, the first time the campaign has been 100 per cent successful since the mid-1960's; total amount raised was \$51,431, Lynton Allred, drive chairman, announced.

Herman Sifford, general manager of the Bridwell Ranches northwest of Hereford, and his son Wayne, foreman of the west ranch, were named conservation ranchers of the year by Tierra Blanca Soil & Water Conservation District.

HEREFORD Lions Club was host to 90 residents of Whiteface and Berger campuses of Gristown U.S.A., presented a \$5,000 cash gift to Gristown and individual gifts to the girls at a Christmas dinner. The county division of American Heart Association received an award for far exceeding its goal of \$3,700 in the 1973 drive with a total of \$3,752; Homer Garrison was chairman for the year.

SCHOOL board members decided to change public school hours to 9 a.m. to 4:30 p.m. when Daylight Saving Time goes into effect Jan. 7, since the previous 8:30 a.m. opening would force pupils to come to school in the dark. A major winter storm with gusty north winds dropped temperatures from almost 60 degrees in the afternoon to a night low of under 10 degrees.

Margaret Bell was selected as Teacher of the Year by Deaf Smith County NEA-TSTA, teachers' organizations. The school board approved a bid of \$763,788 for construction of a new elementary school in the west part of the city to replace the old Central building.

The executive committee of the Hereford Diamond Jubilee allocated unspent funds from the celebration to community improvement programs, the major amounts to the United Way after its drive quota had been reached, to the Community Center and as "seed" money for a proposed YMCA and YWCA here.

After a rush of Christmas shopping, Christmas charitable events and Christmas parties, the town virtually closed for holidays from Dec. 22 to 26. Hereford Medical Auxiliary announced a total of \$3,717 raised in its annual Project Christmas Card, in which area residents contribute to buy equipment for Deaf Smith General Hospital and fund a nursing scholarship.

Jo An Dwyer was chosen executive director for Big Brothers-Big Sisters organization, which was formed after several months of preparation by a governing board headed by Rodney Laughan.

Mothers Host Party For Aggies

A buffet dinner was held for Aggie students and guests Friday evening in the Flame Room of Pioneer Natural Gas building at their Christmas party.

Members of the Hereford Aggies Mothers Club hosted the event. They included Mmes. J.J. Durham, Austin Rose Jr., J.D. Whitaker, Hilrey Aven, Robert Lloyd and Thurman Atchley.

There were 42 present.

Social Security Plans Weekly Visits Here

A representative of the Amarillo Social Security Office will be at the Hereford Courthouse on every Tuesday morning for the months of January, February and March. The service is scheduled 9:15-11:30 a.m. and will pertain to any matters relating to social security or Medicare.

An agent will be in Dinnitt at the county courthouse on various Monday mornings 9:15-11:30. The forums are slated for Jan. 21, 28; February 4, 11, 25; and March 4, 18, 25.

Information can also be obtained by coming to the social security office at 217 East Third Street in Amarillo, or by telephoning 376-2241 (area Code 806). The office is open 8:30 a.m. - 4:45 p.m., Monday through Friday (except national holidays). Residents of Hereford may phone the Amarillo office toll-free by dialing the operator and asking for ENterprise 8-3353.

Clubs, civic groups or classes which would like to schedule a program on social security can call 376-3353.

A.O. THOMPSON
ABSTRACT CO.

Mr. and Mrs.
A. J. Schroeter

Courthouse
Phone 364-1504
P. O. Box 73

Free City Maps
Showing Blocks

INSPECT THE



USED
CAR
BEAUTIES
TODAY

See Leon Roma,
Wylie Thomas,
or Bill Craig.

Doyle Johnson

Chevrolet - Olds 364-2160

Hwy. 385 N. Hereford, Free Pick Up and Delivery

DUCKWALL'S

JANUARY SALE

SUGARLAND MALL

KIMBIES DIAPERS
Disposable
Daytime 30's
Our Reg. \$1.63
\$1.17

PLATEX LIVING BABY PANTY
Plastic - Snap on style.
S-M-L-XL
Our Reg. 84¢
2 For 88¢

RED HEART "WINTUK" KNITTING YARN
Orion Acrylic yarn is machine washable and dryable. Beautiful colors. 4 oz. 4 ply.
Our Reg. \$1.37
97¢ Skein

Ladies' PANTY HOSE
One Size Fit
2 For 76¢

Ladies' KNEE-HI SOCKS
75% Acrylic - 25% Nylon.
Size 9-11
Style No. 802
Our Reg. 98¢
71¢

POLYESTER THREAD
White or Black
Size 50-500 Yds.
Our Reg. 69¢
23¢ Ea.

POLYESTER FIBER FILLING
Perfect stuffing for toys, pillows.
1 lb. Bag
Our Reg. \$1.49
99¢ Bag

BESTFORM DOUBLEKNIT BRAS
Bras styled to fit your figure. Nylon. White.
FIBERFILL CUP
A Cup 32-36 B Cup 32-38 C Cup 34-38
FIBERFILL CUP - Nylon Tricot Straps
A Cup 32-36 B Cup 32-38 C Cup 34-40
Your Choice
Our Reg. \$2.50
\$1.96 Ea.

SOFT CUP
Sizes A Cup 32-36 B Cup 32-38 C Cup 34-40
Our Reg. \$1.99
\$1.44 Ea.

Ladies' BRIEFS
Nylon Satin. White. Pastels.
Sizes 5 to 10
Our Reg. 77¢
2 For \$1.00

Girls' BRIEFS
Nylon Satinette. White. Pastels.
Sizes 2 to 12
Our Reg. 49¢
3 For \$1.00

1000-PIECE PUZZLE
Family fun for jigsaw puzzle fans! Interesting designs in 1000 pieces.
Our Reg. \$1.00
57¢

"DRAG & SHOW" MODELS
Easy-to-assemble hobby kits. Expert, exact styling. Fun to build.
Our Reg. \$2.25
\$1.33 Ea.

SELF-STICK PHOTO ALBUM
Now's the time to put holiday photos in new album! 8 pages.
Our Reg. \$1.99
\$1.57

BOXED STATIONERY
Fine quality "Winter Write" stationery. Choose pretty patterns.
Our Reg. 69¢
44¢ Box

BED BLANKETS
Keep warm on cold winter nights with lovely blankets of Acrylic or Polyester. Solids or stripes.
72" x 90"
Our Special Price
\$3.66

BATH TOWELS
Cotton terry. Assorted styles and colors. Slightly irregular.
Our Reg. \$1.19
88¢

DAN RIVER GINGHAM CHECK SHEETS
50% Polyester - 50% Cotton
Twin Flat or Fitted Sheet
Our Reg. \$2.99
\$2.27 Ea.

Full Flat or Fitted Sheet
Our Reg. \$3.79
\$2.97 Ea.

Pillowcases
Our Reg. \$2.49
\$1.97 Pr.

AFGHAN-CAPE KITS
Crochet a cape or afghan in ripple designs or fisherman knit. Kits contain Acrylic yarn that's machine washable, dryable.
\$4.77 Ea.
Our Reg. \$5.99

FLANNEL BACK TABLECOVERS
Easy-clean vinyl tablecovers. Flannel back. Prints or solids.
52" x 70"
Our Reg. \$2.99
\$1.96

BED PILLOWS
FOAM FILLED
Non-allergic shredded foam. Floral ticking.
2 in Pkg.
\$1.96 Pkg.
Our Reg. \$2.98

SAVE 1/3 to 1/2 ON MANY ITEMS

Calendar Of Events

THURSDAY
 Hereford Study Club, home of Mrs. Noble Howard, 7:30 p.m.
 Alpha Iota Mu Chapter of Beta Sigma Phi Sorority, Flame Room of Pioneer Natural Gas building, 7:30 p.m.
 L'Allegria Study Club, home of Mrs. Jim Carnahan, 9:30 a.m.
 VFW VFW Clubhouse, 8 p.m.
 Kiwanis Club, Civic Club Center, noon
 Jaycees, Dickie's Restaurant, 8 p.m.

FRIDAY
 Campfire Girls Leaders Assn., CFG Lodge, 9:30 a.m.
 Bud To Blossom Garden Club, home of Mrs. Mac Tucker, 9:30 a.m.
 Patriarchs Militant and Ladies Auxiliary, IOOF Hall, 8 p.m.
 Kiwanis Whiteface Breakfast Club, Dickie's Restaurant 6:30 a.m.

MONDAY
 4-H Parent-Leader Assn., Reddy Room of Southwestern Public Service building, 7:30 p.m.
 Order of Rainbow for Girls, Masonic Hall, 7:15 p.m.
 Dawn Lions Club, Dawn Community building, 7 p.m.
 Rotary Club, Civic Club Center, noon.
 Odd Fellows Lodge, IOOF Hall, 8 p.m.
 Evening Lions Club, K-Bob's Steak House, 7 p.m.

TUESDAY
 Hereford Newcomers Club luncheon, Community Center, noon.

WEDNESDAY
 Order of Eastern Star, Masonic Hall, 7:30 p.m.
 Valeda Study Club, home of Mrs. Bill Walden, 8 p.m.
 Lone Star Study Club, home of Mrs. Gaston Baer, 3:30 p.m.
 Heritage Extension Club, home of Mrs. Jim Gonzales, 4:33 Star, 7:30 p.m.
 American Legion, Auxiliary, American Legion Hall.
 North Hereford Extension Club, home of Mrs. U.V. Pierce, 2:30 p.m.
 Hereford Board of Realtors, Dickie's Restaurant, noon.
 Weight Watchers Club, First Baptist Church, 10 a.m. and 6:30 p.m.
 Calorie Patrol TOPS Club, Community Center, 9:30 a.m.
 BPOE Lodge, Lodge Hall, 8:30 p.m.

Open House On Birthday Is Planned

Open house is planned from 2 o 4 p.m. Sunday to honor E.J. Friemel of Umberger on his 50th birthday. His friends are invited to call at the Umberger Parish Hall during the afternoon; they are asked not to bring gifts.
 His birthday will fall on Jan 8. Mr. Friemel has been a resident in this area since early in the century and farmed many years on the place which his son Richard now operates.
 Other children of the honoree are Hilda, Berkenfeld of Pryor, Okla., Paly Haschke of Umberger, Herbert, formerly of Hereford and now living in Canyon, Tex. of Groom and Charles, who lives in Kansas. They will be hosts for the open house.

Donovan Featured As Pied Piper At Star Theatre

Paramount Picture's "The Pied Piper," starring rock star Donovan in the title role, will open for four matinee performances each Friday and Saturday at the Star Theatre in Hereford.

Rated G for children and general audiences, the picture is the age-old story of the famous flute player who leads the thousands of rats, and later children, out of the city of Hamelin.

Showtimes will be Friday and Saturday at 12:30 p.m.; 2:10 p.m., 3:55 p.m. and 5:35 p.m.

The motion picture is based on a fable which originated during the time of the Great Plague in the 14th Century, which also inspired many writers and poets over the years.

"The Pied Piper" is an especially apt fable for the 20th century. In fact everyone involved with the production sees it as a parable for our time.

Donovan feels a tremendous affinity for the part he plays. "I've researched the legend of the Piper as far as I can," he says. "He thinks that the Piper of Hamelin was in reality a musical medicine man who had learned his magic in the East. The fable definitely declares that he was a much travelled man; he had been north and east and west and south. In the East they have what are called street fakirs, musical medicine men who can do precisely what the Piper did—spirit away rats, charm snakes, walk on nails, hypnotize children. The holy men of India would find no difficulty in understanding how the Piper communicated through music with children and animals."

"The Pied Piper" was filmed in London and in the little town of Rothenburg-on-the-Tauber, a small Bavarian city not too far from Frankfurt and Nuremberg. Rothenburg looks exactly the way it did 500 years ago; a medieval, walled town with towers, gates, ramparts, spired gingerbread houses and little hilly streets. It looks like a picture-book and is, in fact, a great tourist attraction. It is also free of jet sounds, and as such, was doubly attractive as a film location.

Producers David Puttnam and Sanford Lieberson gathered an interesting cast of top English actors, in addition to Donovan. Jack Wild, the Artful Dodger of "Oliver!" plays the crippled young Gavin. The youngest cast member is 12-year-old Cathryn Harrison, granddaughter of Rex Harrison, who plays the young daughter of the Burgomeister.



One thing the early Greeks didn't have a word for was Africa, which they considered a part of Asia.



Arab legend claims that Alexander the Great carried a black flag and a white one with which he could create night and day at will!

The Hereford Brand, Hereford, Texas, January 3, 1974

THURSDAY
 WARD THRU SATURDAY WARD
JAN. 3-4-5

10% OFF MERCHANDISE

IN
OUR BIG FALL '73 GENERAL CATALOG AND CHRISTMAS CATALOG
3 BIG DAYS TO SAVE
 114 PARK AVE. HEREFORD, TEXAS

SAFeway GET IT TOGETHER

IT ALWAYS PAYS TO COMPARE TRIM AS WELL AS PRICE...

Here's How We Trim Our Porterhouse and T-Bone Steaks

Fat portion removed; it's not steak meat. Top end of bone and excess fat cut off.

SIRLOIN STEAK

Heavy pieces of backbone removed. Excess fat trimmed off. Note generous porportion of fine steak meat to bone.

FRESH FRYERS **43¢** lb
 Whole Body (Cut-Up 1b. 48¢)

SLICED BACON **\$1.97** 2-lb. Pkg.
 Safeway (1-lb. pkg. 99¢)

RIB ROAST **\$1.39** lb.
 USDA Choice Large End!

BEEF ROAST **\$1.33** lb.
 Cross Rib Steak (Boneless Cross Rib)

Sausage Safeway Brand (2-lb. pkg. 21") **\$1.09**

Sausage Oscar Meyer Link **\$1.29**

Sausage Eckrich Smoked **\$1.59**

Ham Steak Oscar Meyer Low Price **\$2.29**

Sliced Bacon Wilson Corn King **.98¢**

Sliced Bacon Dole Val Pak **11¢/lb. \$1.63**

Bologna Starting Junior By The Piece **.79¢**

Wieners Safeway All Meat **12-oz. 79¢**

Beef Franks Wilson Certified **12-oz. 79¢**

Beef Steak US Choice Top Round Boneless **1-lb. \$1.69**

Beef Steak US Choice Bottom Round Boneless **1-lb. \$1.59**

Beef Steak US Choice Sirloin Tip Boneless **1-lb. \$1.69**

FRUIT FLAVORS HI-C DRINKS

Delicious Drinks

46-oz. Can

34¢

SUPER SAVER

DETERGENT PAR LIQUID

48-oz. Bottl.

55¢

EVERYDAY LOW PRICE!

DEL MONTE GOLDEN CORN

17-oz. Can

23¢

EVERYDAY LOW PRICE!

DEL MONTE SWEET PEAS

17-oz. Can

25¢

EVERYDAY LOW PRICE!

FRESH COFFEE FOLGERS

2-lb. can 21" 3-lb. can 13"

1-lb. Can

\$1.09

EVERYDAY LOW PRICE!

LOOK FOR SUPER SAVERS

EVERYDAY LOW PRICE

Fruit Drinks Cragmont 16-oz. 31¢

Soda Pop Cragmont 12-oz. 10¢

Salad Olives Sheale 10-oz. 59¢

Dill Pickles Zappi Hamburger 32-oz. 55¢

EVERYDAY LOW PRICE

Tomato Sauce Town House 16-oz. 23¢

Honey Empress Brand 24-oz. \$1.29

Dog Food Pooch Nuggets 10-lb. Bag \$1.65

Disinfectant Listerol Spray 14-oz. Can \$1.29

EVERYDAY LOW PRICE

Spray Starch White Magic 22-oz. Can 48¢

Kimbies Daytime Diapers 30-ct. Box \$1.75

Prune Juice Dal Monte 32-oz. Bottl. 57¢

Tang Mix Orange Mix 27-oz. Jar \$1.35

EVERYDAY LOW PRICE

Fruit Helper Betty Crocker 8-oz. Box 45¢

Sweet Peas Garden of Eatin' 16-oz. Can 19¢

Spinach Del Monte 15-oz. Can 25¢

Diet Mix Slender Instant 4-oz. Pkg. 85¢

EVERYDAY LOW PRICE

Viennas Wilson Sausage 46-oz. Can 35¢

Chili w/Beans Town House 15-oz. Can 45¢

Pork & Beans Town House 16-oz. Can 21¢

Popcorn Town House 2-lb. Box 29¢

SAFeway FROZEN FOOD BUYS

ORANGE JUICE **43¢** 12-oz. Can
 Bel Air Frozen Juice!

BEL AIR WAFFLES **14¢** 5-oz. Pkg.
 Bel Air Frozen Waffles!

Grape Juice Welch's 6-oz. 62¢

Corn On Cob Bel Air 8-oz. 69¢

Cut Corn Bel Air 32-oz. 69¢

French Fries Scotch Treat 5-lb. Pkg. \$1.10

Hash Browns Bel Air Potatoes 2-lb. Pkg. 45¢

Meat Pies Manor House 8-oz. Pkg. 28¢

Mex. Dinners Morton Downers 16-oz. 59¢

Cherry Pies Bel Air 24-oz. 65¢

Apple Pies Bel Air 24-oz. 49¢

Pecan Pies Fudge Pie 2-lb. Pkg. \$1.85

Egg Noodles Reams Noodles 12-oz. 55¢

Pizza Bel Air Sausage 18-oz. Pkg. \$1.09

Pizza Totinos Hamburger 18-oz. 98¢

Donuts Morton Glazed 10-oz. 69¢

Honey Buns Morton Buns 9-oz. 49¢

Enchilada El Chico Dinner 12-oz. 59¢

Niblet Corn Green Giant In Butter Sauce 10-oz. 42¢

Cream Corn Green Giant In Butter Sauce 10-oz. 42¢

SAFeway REFRIGERATED FOODS

MARGARINE **48¢** 1-lb. Ctn.
 Coldbrook Soft Tub Margarine!

Margarine Sunbham's Corn Oil 1-lb. Pkg. 49¢

Biscuits Mrs. Wrights Butterbuds 8-oz. Can 12¢

Rolls Pillsbury Rap 8-oz. Pkg. 34¢

Cookies Pillsbury Brand 18-oz. Pkg. 58¢

Biscuits Roman Meal 12-oz. Can 33¢

Cheese Safeway Amer. Single Sliced 8-oz. Pkg. 69¢

Swiss Cheese Kraft Mild 6-oz. Pkg. 69¢

Cheese Kraft Hallmark Chunk Cheddar 10-oz. Pkg. 98¢

Cheese Loaf Kraft Velveeta 2-lb. Pkg. \$1.59

Cheese Loaf Breaze Imitation 2-lb. Pkg. \$1.09

Margarine Kraft Miracle 1-lb. Pkg. 45¢

Cheese Kraft Amer. Single Sliced 12-oz. Pkg. \$1.08

Cheese Lucerne Pizza Cheese 8-oz. Pkg. 62¢

Cheese Kraft Shredded Mozzarella 9-oz. Pkg. 89¢

DUETS FINE DINNER CHINA

DINNER PLATE **89¢** Ea.

COVERED BUTTER DISH **\$3.59** Ea.

Keepsake JEWELRY

Beautiful Mr. and Mrs. bridal sets... a brilliant perfect Keepsake diamond engagement ring with matching wedding rings. Master-crafted and fully guaranteed.

KESTER'S JEWELRY

Across from the Post Office in Downtown Hereford

This is neither a solicitation to buy nor an offer to sell these securities. Offer is made by prospectus only.

\$230,000

FIRST MORTGAGE BONDS

Interest Payable Semi-Annually

8 1/2%

MATURITIES: 3 1/2 years through 9 1/2 years
MULTIPLES OF: \$1,000-\$500-\$250

For Information Write or Call

EMMANUEL BAPTIST CHURCH

208 Cunningham Drive
Colorado Springs, Colorado 80911
Phone (303) 392-5545 or 392-3355
BILLY R. HAMM, Pastor

J.V. In Tourney

Herd Plays Today

After finishing second in the Borger Tournament to close out the year last Saturday, the Hereford Whiteface cagers open 1974 action in Amarillo tonight as they take on the Caprock Longhorns.

The Herd, with a 13-6 won-lost record, lost a close 50-45 decision to host Borger in the tourney Saturday night. After trailing the first two periods,

Hereford battled back to take a 37-35 advantage going into the final stanza. Borger outscored Hereford, 15-4, in the final period.

The Herd missed the services of Dan Vander Zee when he fouled out with 4 1/2 minutes left in the game. Mike Albar was the only Whiteface to hit double figures as he meshed 16 points. Dennis Nogger had 9, Vander

Zee 8, and James Harris 6. Vander Zee and Harris were named to the All-Tournament team.

Leading Borger in the championship game were Chuck Forrest with 15 points and Richard Mitchell with 14. Hereford was charged with 19 fouls in the contest, and Borger drew a total of 16. The Bulldogs had clipped the Herd by a 16-point margin earlier in the season.

The Hereford JV starts off the New Year today in the Stratford Tournament, meeting Surray at 11:30. The JV will also go to Amarillo tonight to play a preliminary game against Caprock.

Coach Barry Arnwine will introduce his cagers to the Whiteface Booster Club Monday night when the club holds a 7:30 p.m. meeting in the high school cafeteria.

Umberger Rites Held For Nettie Frerich

A funeral mass was conducted for Mrs. Nettie Frerich, 70, of Amarillo, in St. Mary's Catholic Church at Umberger Monday morning, and graveside services at the Carlsbad, N.M. cemetery that afternoon. Mrs. Frerich died Saturday morning. She had moved to Amarillo from Carlsbad seven years ago.

She is survived by two daughters, Mrs. Bill Thompson of Amarillo and Mrs. Rick Boucher of Dallas; three sons, Leon of Carlsbad, Bill of the U.S. Navy now stationed in Japan, and Anthony of Denver; a sister, two brothers, 16 grandchildren and three great-grandchildren.

Letters To The Editor

Unhappy About School Policy

Dear Editor,
I am an ex student and basketball player from Hereford High School and I am readily becoming ashamed to admit it. I came home over the Christmas holidays and was absolutely astonished at the way certain school officials welcomed home the exes of H.H.S.

There was a large number of college students, many now playing college basketball, that had gotten together and wanted to work out in one of the local gyms. Hereford has three excellent gyms; High School, La Plata and Stanton, and it soon became evident that to gain entry to one of these gyms was more difficult than getting into Fort Knox.

After calling many coaches and administrative personnel and being turned down by them all, I finally decided to call Mr.

Roy Hartman, the Superintendent of Hereford Public Schools. He readily became outraged at my persistence in trying to gain entrance to one of these gyms and gave as his reason for a negative answer, the fuel shortage.

Although it is true that one must have light to play basketball, very little is needed in the middle of the day and this amount of energy is much less in comparison to that expended by many youths driving around looking for something to do. Mr. Hartman suggested that because we were no longer in the Hereford School system that we had no right to make such a request. If this is the case then why are my parents still required to pay school taxes of which they pay a great deal.

Mr. Hartman and the other school officials may be following regulations that are

set forth to them, and if so maybe more citizens should look into the matter and see if these are the kind of regulations that we want in our school system.

I, and the others with me were astounded at the attitude that Mr. Hartman took. He suggested that possibly one of the reasons that our Senior class of '73 did not excel in our athletic competition last year was because our class held such an attitude as I displayed to him in trying to gain entrance to a gym.

Maybe it's the other way around, he certainly displayed a negative attitude toward basketball to me, although he tries to leave an impression of a good supporter of our high school team. I wonder why he wasn't in Borger last Saturday night when Hereford was in the playoffs of the Borger tournament.

Maybe it's time that parents tried to make available to their children the facilities that Hereford now has. These buildings are doing very little good when they are constantly padlocked.

I will soon return to college and may not be home again for some time but I sincerely hope that this letter and what I have gone through will inspire other people to write Mr. Hartman and our school board in order to find a place where our youth can occupy their time besides on the streets.

Sincerely yours,
Gary R. Hicks
Cook Courty Jr. College
Box 815
Gainesville, Tex. 76240

at SAFEWAY

 ROUND STEAK USDA Choice Center Cut Bone-In lb. \$1.33	 GROUND BEEF Safeway Regular Premium lb. 89¢
Sirloin Steak USDA Choice Beef 1 lb. \$1.39	7-Bone Roast USDA Choice Center Cut 1 lb. 98¢
T-Bone Steak USDA Choice Beef 1 lb. \$1.59	Round Bone USDA Choice Beef Roast 1 lb. \$1.18
Porterhouse USDA Choice Beef Steak 1 lb. \$1.69	Heel of Round USDA Choice Beef Roast 1 lb. \$1.33

FOR QUALITY FOODS, USDA CHOICE BEEF CUTS, FRESH CRISP PRODUCE AND A WIDE SELECTION OF DAIRY AND FROZEN FOODS. COME SHOP SAFEWAY WHERE YOU CAN GET IT TOGETHER EVERYDAY!

FOR YOUR CONVENIENCE SAFEWAY SALES REPUBLIC MONEY ORDERS!

Prices Effective Thru Jan. 5 in Hereford, Texas



TOWN HOUSE FRUIT COCKTAIL 17-oz. Can EVERYDAY LOW PRICE! 31¢	WHITE MAGIC DETERGENT 49-oz. Box EVERYDAY LOW PRICE! 65¢	DETERGENT TIDE 49-oz. Box EVERYDAY LOW PRICE! 87¢	TRULY FINE PAPER TOWELS Lg. Roll EVERYDAY LOW PRICE! 33¢	NU MADE SALAD DRESSING Fine Quality! 32-oz. Jar EVERYDAY LOW PRICE! 67¢ SUPER SAVER
--	--	---	--	---

TO GET EXTRA SAVINGS!

EVERYDAY LOW PRICE Egg Noodles 8-oz. Pkg. 34¢	EVERYDAY LOW PRICE Shortening 3-lb. \$1.17	EVERYDAY LOW PRICE Corn Meal 5-lb. 65¢	EVERYDAY LOW PRICE Crackers 1-lb. Box 35¢	EVERYDAY LOW PRICE Cookies 32-oz. Pkg. 59¢
EVERYDAY LOW PRICE Tuna Helpers 7-oz. Pkg. 59¢	EVERYDAY LOW PRICE Salad Oil 48-oz. \$1.55	EVERYDAY LOW PRICE Tomato Soup 10-oz. Can 11¢	EVERYDAY LOW PRICE Pretzels 10-oz. Pkg. 36¢	EVERYDAY LOW PRICE Breakfast 8-oz. Pkg. 59¢
EVERYDAY LOW PRICE Dinners 8-oz. Pkg. 67¢	EVERYDAY LOW PRICE Gold Medal 5-lb. 96¢	EVERYDAY LOW PRICE Tomato Soup 10-oz. Can 13¢	EVERYDAY LOW PRICE Tortilla Chips 8-oz. Pkg. 29¢	EVERYDAY LOW PRICE Soda Pop 2 12-oz. Cans 25¢
EVERYDAY LOW PRICE Quick Oats 42-oz. Pkg. 65¢	EVERYDAY LOW PRICE Bisquick 40-oz. Pkg. 89¢	EVERYDAY LOW PRICE Soup 10-oz. Can 17¢	EVERYDAY LOW PRICE Cookies 1-lb. Box 59¢	EVERYDAY LOW PRICE Dressing 8-oz. Bott. 35¢

HEALTH & BEAUTY AIDS

CONTAC Cold Capsules 10-ct. Pkg. \$1.29	VICKS Formula 44 Cough Syrup 6-oz. Botl. \$1.59
Cough Syrup Vicks Formula 44 D Botl. \$1.99	Hair Spray Truly Fine 13-oz. Can 55¢
Vaporub Vicks Cold Ointment 1.5-oz. Size 59¢	Shampoo Truly Fine w/Protein 18-oz. Botl. 78¢
Vitamin E Safeway Brand 100-ct. \$2.99	Maalox Liquid Anti-Acid 12-oz. \$1.19
Aqua Net Hair Spray 13-oz. Can 63¢	Aspirin Safeway Brand 100-ct. 29¢

SINEX SPRAY Nasal Spray 5-oz. Size **EVERYDAY LOW PRICE! \$1.19**

VICKS NYQUIL Cold Medicine 6-oz. Botl. **EVERYDAY LOW PRICE! \$1.35**

FRESH PRODUCE AT SAFEWAY

ORANGES Sunkist Oranges—Seedless And Easy to Peel 5 lbs. \$1.49	APPLES Washington State Red or Golden Delicious Apples! 4 lbs. \$1.49	GRAPEFRUIT Texas Sweet Ruby Red Grapefruit—Extra Big Savings! 7 for \$1.49
---	---	--

Potatoes All Purpose Russets 10-lb. Bag 89¢	Green Onions Mid Flavor 2 for 29¢	Tomatoes Vine Rippe Cherry 39¢
Bananas Golden Rippe 14¢	Red Radishes Large Bunch 2 for 29¢	Turnips Purple Top 2 lbs. 29¢
Lemons Sunkist Large Size 5 for 49¢	Yellow Onions Cooking Onions 2 lbs. 19¢	Celery Large Stalk 25¢

Answers Letter

Dear Editor:
In answer to your letter Mr. Drerup:
America is a country where any farm laborer can own a piece of land; if he is really willing to work and sacrifice for it. If he ever expects it to be given to him; he has already lost the right to own land and he has lost his freedom.
He is a serf and a prisoner behind an iron curtain; no matter whether that land is located here or in some distant country.
You have no understanding of the whole concept of the great American dream of our God fearing, stalwart forefathers. These men had known serfdom on lands owned by church and state. America for them was a land of utopian opportunity; a land where strong men who were willing to face hardships, even death, who were willing to work, sweat and toil could become land owners.
These men understood that the government which governs most extracts most; they knew that if the state were to give them food, clothing, land and the circus; then they would become the vassals of the state as had generations of men in the past; they knew that they would be told when to plant and when to sow; when to buy and when to sell; what would be extracted for the state and what they could charge for the meager amount they had left.
These men wanted no over lords, they were free men.
I wonder if Mr. Drerup has ever seen houses made of paper, rag filth, bottles, cans and boxes; noisome hovels of vermin and disease? These can be seen in several parts of the world, but perhaps the best example of this human suffering can be viewed in Hong Kong.
These minute cubicles unfit for habitation are occupied by poor, miserable human beings who have one thing in common, a dream that they too, can one day be free. They are fleeing from the Communism that Mr. Drerup believes is so very beautiful. These people are fleeing from the prison of an iron curtain which gives them all, but freedom.
Every day this country is losing its idealism and its freedom; everyone wants something for nothing. Free men must guide the country; The country must never dictate to free men; if it does then men are no longer free.
Sincerely,
S. Curl
609 W. 46th St.
Kansas City, Mo. 64112

For God So Loved The World

- FIRST BAPTIST CHURCH**
Doug Manning, Pastor
Fifth and Main Streets
- FRIO BAPTIST CHURCH**
Rev. Samuel B. Ogan, Pastor
Frio Community
- WESTWAY BAPTIST CHURCH**
Rev. Dick Hollis
- MT. SINAI BAPTIST CHURCH**
Rev. C. H. Frost, Pastor
302 Knight Street
- SUMMERFIELD BAPTIST CHURCH**
Rev. Niel Foster
- TEMPLO CALVARIO
ASAMBLA DE DIOS**
13th & Ave. H
Rev. Ralph J. Molina
- CHURCH OF JESUS CHRIST OF
LATTER DAY SAINTS**
(Mormon)
Country Club Drive
- TEMPLE BAPTIST CHURCH**
Rev. J. L. Bozeman
Forrest Ave. and Ave. K
- GREENWOOD BAPTIST CHURCH**
"A Bible Baptist Church"
Rev. Prentice D. Smith, Pastor
- IGLESIA METODISTA
SAN PABLO**
Rev. Thomas Balderas, Pastor
- SAN ANTONIO A LA IGLESIA**
North 25 Mile Avenue
- TEMPLO BAUTISTA MEMORIAL**
(A.O. Thompson)
Robert Foster, Pastor
- LA IGLESIA DE CRISTO**
Sunset and Plains Ave.
Pete Reyna, Minister
- CENTRAL CHURCH OF CHRIST**
J.T. Marlin, Minister
148 Sunset Dr.
- PARK AVE. CHURCH OF CHRIST**
On Harrison Highway
- TRINITY BAPTIST CHURCH**
Southern Baptist
Rev. C.F. Powell
4th and Jackson
- SAINT JOHN BAPTIST CHURCH**
400 Mable St.
Rev. C.W. Allen, Pastor
- PENTECOSTAL CHURCH
OF JESUS CHRIST**
So. Miles and Grace St.
364-5119
Rev. Joseph A. Myers

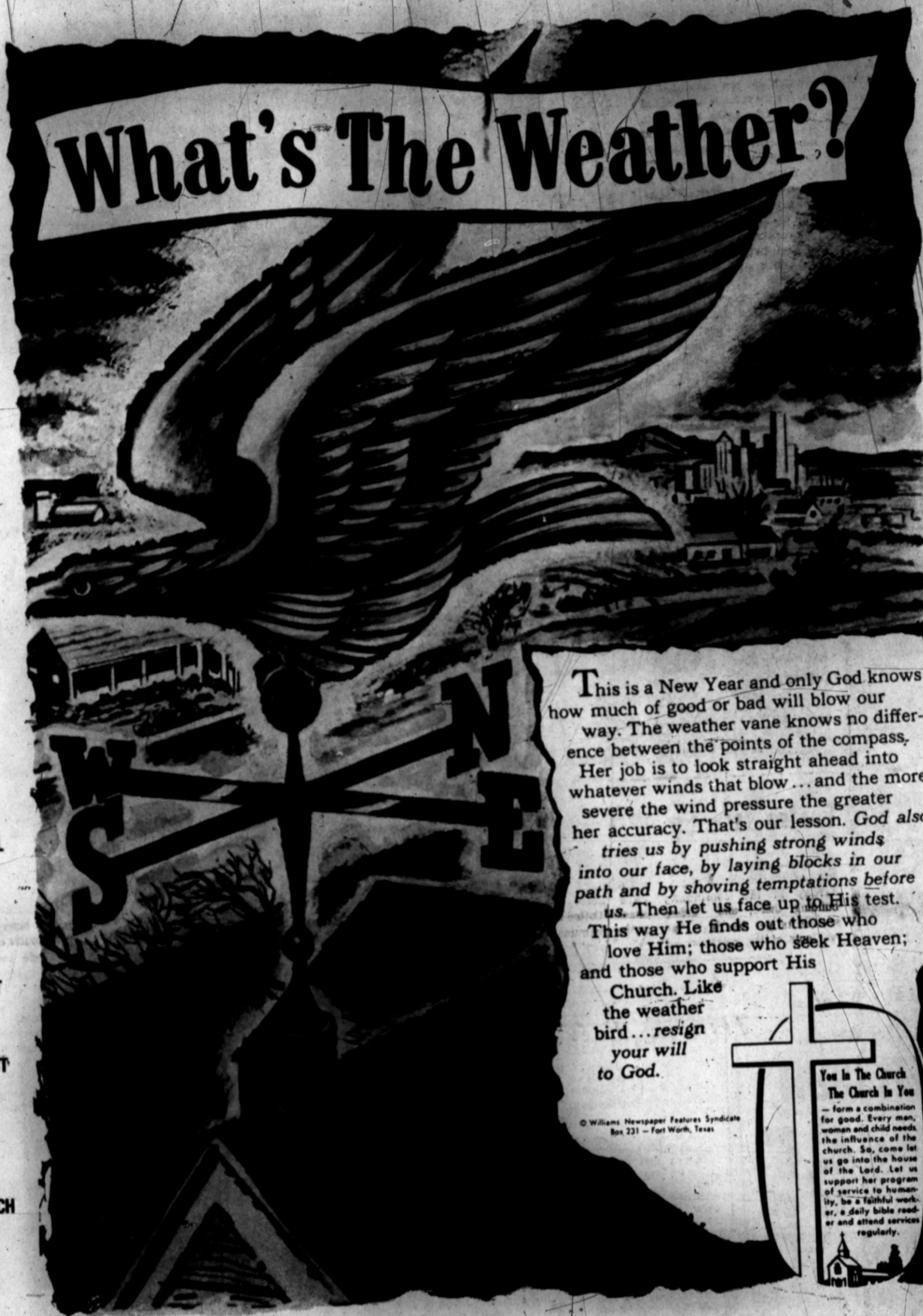

What's The Weather?

This is a New Year and only God knows how much of good or bad will blow our way. The weather vane knows no difference between the points of the compass. Her job is to look straight ahead into whatever winds that blow... and the more severe the wind pressure the greater her accuracy. That's our lesson. God also tries us by pushing strong winds into our face, by laying blocks in our path and by shoving temptations before us. Then let us face up to His test. This way He finds out those who love Him; those who seek Heaven; and those who support His Church. Like the weather bird... resign your will to God.

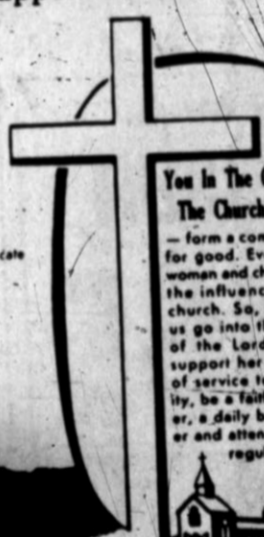

**You In The Church
The Church In You**
— form a combination for good. Every man, woman and child needs the influence of the church. So, come let us go into the house of the Lord. Let us support her program of service to humanity, be a faithful worker, a daily bible reader and attend services regularly.

© Williams Newspaper Features Syndicate Box 231 - Fort Worth, Texas

- FIRST METHODIST CHURCH**
Dr. Jordan Grooms, Pastor
501 North Main
- WESLEY UNITED
METHODIST CHURCH**
Rev. Don McWhorter, Pastor
410 Irving
- BIPPUS COMMUNITY CHURCH**
Gene Brock, Pastor
Preaching 1,2,3,4 Sundays
5th Sunday, Singing
- AVENUE BAPTIST CHURCH**
Rev. Norman MacDonald
130 North 25 Mile Ave.
- CHRISTIAN ASSEMBLY**
Interdenominational
Christian Fellowship in the Fullness
of the Holy Spirit
Rev. Tom Starcke,
South Main — 364-5556
- ASSEMBLY OF GOD CHURCH**
Rev. Homer T. Goodwin, Pastor
15th and Ave. F
- IMMANUEL LUTHERAN
CHURCH**
Rev. Hermon Schelter, Pastor
Park Ave. and B Street
- SEVENTH DAY ADVENTIST
CHURCH**
Elder Hollis A. Morel, Pastor
West Park Addition
- MISSION DA SAN JOSE**
Labor Camp
- CHURCH OF THE NAZARENE**
Rev. Max Jetton, Pastor
16th & Blackfoot
- GRACE GOSPEL CHURCH**
Thirteenth and Avenue K
- ST. THOMAS EPISCOPAL
CHURCH**
William A. Lang, Jr. Vicar
601 West Park
- ST. ANTHONY'S ROMAN
CATHOLIC CHURCH**
Rev. Bernard McGorry, Pastor
Harrison Highway at 25 Mile Ave.
- FIRST PRESBYTERIAN CHURCH**
610 Lee Street
Rev. Roger B. Knapp
Minister
- FIRST CHRISTIAN CHURCH**
Rev. Eugene Brink, Pastor
West Park Avenue
- DAWN BAPTIST CHURCH**
Rev. Gene Meacham

These Hereford Business Firms Make This Page Possible in the Interest of a Christian Community.

- | | | | |
|---|--|--|---|
| CARL McCASLIN LUMBER CO.
Carl G. McCaslin | DAVIS IMPLEMENT CO.
W.L. Davis, Jr. | PITMAN GRAIN CO.
John D. Pitman | CASE POWER & EQUIPMENT CO.
L.B. Herring, Mgr. |
| KELLEY ELECTRIC
Virgil and Doug Kelley | HEREFORD IRON & METAL
Anson A. and June Dearing | HAROLD CLOSE DRUG
Harold Close | A to Z TIRE & BATTERY
Troy Rhodes |
| McRIGHT GARAGE & SUPPLY
Mr. and Mrs. Clyde Oldham | CONSUMER'S FUEL ASS'N.
"Bud" Sparks, Mgr. | FARMERS' DRIVE IN
Troy Moore. | HEREFORD STATE BANK
The Friendly Bank |
| FIRST NATIONAL BANK
Since 1900 | THE INK SPOT, INC.
C.E. Coleman, Jr. | SUTT'S AUTO SUPPLY COMPANY | LOERWALD BROS.
231 W. 2nd |
| ROCKWELL BROS. & CO.
Ray Chambliss, Mgr. | HI-PLAINS SAVINGS & LOAN ASSOC.
Myron Morgan, Mgr. | DOYLE JOHNSON CHEVROLET - OLDS
Doyle Johnson | WAC SEED, INC.
Hugh Clearman-Armon, Lauderback |
| OGLESBY IMPLEMENT CO.
Cecil Oglesby | GILLILLAND - WATSON FUNERAL HOME
Marlin Gilliland-John Gilliland
Charles Watson | BOYD MACHINE & SUPPLY
Mr. and Mrs. James J. Boyd | COIN OPERATED MAYTAG LAUNDRY
Two Locations: 213 13th
1009 Park Ave.
Herb and Dennis Edwards, Owners |

The Hersford Brand, Hereford, Texas, January 3, 1974

At The Library

Mission-Destroy Secret Weapon

His Majesty's U-Boat by Douglas Reeman is the book being featured at the Deaf Smith County Library this week. The story, set during World War II, reveals a secret plot to destroy the enemy, the German's Lieutenant Commander

Steven Marshall is ordered to return to the Mediterranean even though it holds bitter memories.

The library is open to the public on weekdays from 9 a.m. until 5 p.m. and Saturdays until noon.

HIS MAJESTY'S U-BOAT

By Douglas Reeman
It is February, 1943 when Lieutenant Commander Steven Marshall, R.N., brings his submarine, sole survivor of a flotilla decimated in Mediterranean waters, back to British waters.

At a secret base at the northernmost tip of England Marshall is introduced to his new command—a captured German U-boat which he is to take back to the Mediterranean theater, with all the bitter memories it holds for him, to wreak havoc on the enemy. For Marshall this is a new

kind of war, one which takes him and his new command to the Italian coast to land Allied agents, into enemy harbors to attack naval installations, and ashore on the Italian coast to sabotage and destroy a factory producing a secret weapon which poses a threat to the pending Allied invasion.

This is a many faceted story—a book crammed with incident, conflict between interesting characters, and more than a modicum of romance as Marshall becomes involved with a young Frenchwoman working as an agent for the Free French. It is an always readable and exciting novel—truly vintage Reeman.

CLUB TO MEET

Young Homemakers Extension Club will meet at 9:30 a.m. Tuesday in the home of Mrs. Richard Patzig, 232 Elm, for its first program of the new year.



LP Students Honored

Named as Students of the Six Weeks at La Plata Junior High were Teena Self and Terry Bilbrey. The two were recognized at the Lions Club meeting Wednesday, and were presented pens by secretary Lanny Crump. Students are selected on the basis of grades, attitude, friendliness and participation in school activities.

Reinauer Makes Intercept

Naval LT R.M. "Bob" Reinauer, flying the all-weather A-7 Corsair fighter bomber from the aircraft carrier USS Franklin D. Roosevelt, shown intercepting a Russian AN-12 "Cub" transport aircraft while flying a routine reconnaissance mission in the eastern Mediterranean.

LT Reinauer, since joining Attack Squadron FIFTEEN in October, 1971, has made two deployments to the Mediterranean while accumulating over 700 flight hours in the A-7 Corsair II and logging over 300 carrier arrested landings.

LT and Mrs. Reinauer, the former Brenda Tietjen of Schulenburg, Texas, are combining his present deployment with European leave. They will visit Spain, Italy, France, Germany,

Greece and Switzerland prior to returning to Hereford in March, 1974.

LT Reinauer is the son of Mr. and Mrs. Joseph F. Reinauer of Hereford and is a 1965 graduate of Hereford High School and 1969 graduate of the University of Texas at Austin.

ON VETERANS' PENSIONS
President Nixon has signed a bill giving a 10 per cent cost-of-living increase in monthly pensions to about 2.4 million military veterans and their survivors, effective Jan. 1.

COURT ON SEARCHING
The Supreme Court ruled 6-3 that a person arrested for a traffic violation may be searched without a warrant and convicted of another offense if evidence is discovered.



Easter January 42 Party Slated

Easter community's monthly 42 party is scheduled at 7 p.m. Friday in the community building there, and "unless snowdrifts get too high" all residents of the neighborhood

are invited to be present. Each family is asked to bring card tables, dominoes and snacks. Coffee will be prepared at the community house for the refreshment hour.

THERE IS NO FERTILIZER SHORTAGE!

While the principal business of our feedlot is the production of beef for a hungry world, there are certain byproducts of our operations which are available to help in the operations of other segments of agriculture. One such product is nutrient-rich manure, offering unique fertilization potential.

Through tests conducted at the U.S.D.A. Southwestern Great Plains Research Center at Bushland, Texas, we have learned specific facts relating to the use of our solid wastes as fertilizer. For example, application of only ten tons of solid waste material to an acre of moderately irrigated crop lands has been sufficient to obtain maximum yields. There is a residual effect available through manure fertilization: the process of decomposition continues to provide nutrients, at a reduced level, through the second and even third years after application!

There are definite economic advantages to the crop producer using the manure fertilization system. Initial cost, of course, and also the economies of the methods of application. No special equipment is required; the material is deep plowed into the field and application can be made at the time of working fields prior to planting (the farther in advance of planting the better). Thus, fertilization occurs as a course of normal operation, with standard plowing equipment, resulting in fewer man hours required and, particularly important in light of the energy crisis, less fuel consumption.

The table below lists the nutrient content of manure sampled from 23 feedlots on the Texas High Plains, giving the range, average percentages and average pounds of nutrients present in ten tons.

	RANGE	AVERAGE	AMT. IN 10 TONS
Nitrogen	1.16 - 1.96	1.34	268 lb
Phosphorus (P ₂ O ₅)	.73 - 1.95	1.21	243
Potassium (K ₂ O)	.90 - 2.83	2.17	362
Sodium	.29 - 1.43	.74	148
Calcium	.81 - 1.75	1.30	260
Magnesium	.32 - .66	.50	100
Iron	.08 - .66	.21	42
Zinc	.005 - .042	.009	1.8
Water	20.9 - 54.5	34.5	6,900

HERE ARE SAMPLE YIELDS IN POUNDS PER ACRE

Grain Sorghum Yield in Lbs/A			
No Treatment	Manure 10 T/A	Manure 20 T/A	Fertilizer 240 lbs. N/A
4-yr. average	4735 lbs./A	6366 lbs./A	6232 lbs./A

Corn Silage Yield in Tons/A (70% water)			
No Treatment	Manure 10 T/A	Manure 20 T/A	Fertilizer 200 lbs. N/A
3-yr. average	19.9 T/A	21.7 T/A	22.7 T/A

THERE CAN BE A DEFINITE ADVANTAGE TO YOU THROUGH FARMING WITH MANURE FERTILIZATION. PLEASE TALK TO US. WE'LL BE GLAD TO HELP YOU FIGURE THE ECONOMICS AS THEY APPLY TO YOUR OWN OPERATION!

CONTACT YOUR LOCAL FEED YARD.

By The Garden Gate With Glad

THE NEW YEAR
So here is 'now dawning another new year . . . 1974. Think, will you let it slip uselessly away?

Out of eternity the New Year will be born, And when its cycle is completed

Into eternity at night it will return And from all eyes it will be hid.

THINK now what you will do to make its record . . . good or bad?

I am well aware that there are many things looming on the horizon as the New Year approaches. We may have to change our way of living, cut down on use of gasoline, fuel, paper products, probably other things which we think are necessities.

America has never failed to meet a challenge and she will meet this one and come out of it a better stronger nation, if we do our best. When all things are measured, we of America have so much to be thankful for and many promises to look forward to, let us be glad that we live in the United States of America. It is indeed the grandest nation in all the world.

THINGS for gardeners to do in preparation for 1974.

Get out your plan for landscaping and check it to see what was accomplished last year. If you do not have a landscape plan, make one. List plants you plan to continue to grow, and those you wish to discard. Make a list of new plants to be added.

Check flower beds, lawns, trees, shrubs and other plants. If the fall cleanup was not completed, make use of days in which some of garden chores can be completed. A well kept garden will tend to keep down insects and make garden tasks lighter in the spring.

One which has debris and old plants standing will cause insects to hibernates and these will give trouble another year. Plow or spade some of the flower beds and vegetable garden, and add mulch to the soil. The gardener that has planted rye or other grain for soil building is the lucky one.

Make list of plans to make the lawns better and one which will cut down use of water. If there are bare spots these should be spaded. The old roots which have been killed destroyed. Prepare it for future planting.

If shrubs, roses, trees or other plants are rubbing against the house or fence, remove these limbs or branches, or fasten securely to stake or trellis.

Make a note that these should be sprayed with an emulsion which contains some oil to aid in keeping down insects. This is a protective measure all gardeners should use. However roses or evergreens should not be sprayed.

New catalogues are arriving. They will be good reading on the long shut-in winter days. Study carefully and plan to plant more seeds this year. We have been warned that plants will be much higher the coming growing season.

Even though seeds may be listed a dollar per packet, one can gain by planting and growing their own plants. Begonias, geraniums and many other plants can be grown from seeds for transplanting.

If you are growing house plants, watch them for insects. If insects do attack them, wash thoroughly with a soap suds. Tide suds are good for such

purposes. Remove wilted leaves. Clean around the base of stalks, removing waste material which has collected. Feed regularly, reading directions carefully. Select a well proven plant food, and use the one recommended for the plant. Violet food for violets, etc. Turn pots regularly, thus the plant will be better grown and more attractive.

Chickweed is already showing in the flowerbeds. This is a real garden pest. They grow best in cool weather. To control, spray with a specific chickweed killer. To assure a better kill, bruise the plants so they will absorb poison more rapidly. Winter days are a good time to read garden magazines which have been stacked away when you were too busy to read thoroughly. Also there are many new books pertaining to today's gardens and flower arranging.

Some which are recommended are: A Tree Grows Up, by J.M. Gulcher and R.H. Noailles. The authors have a vast knowledge of trees and their miracle performance. Anyone who grows a tree adds much to control environmental problems. Man cannot exist without trees.

Another new trend is that of growing living gardens or designs of landscaping in the house. Living Flower Arrangements by Margaret Davis explains various ways container grown plants can be used.

Cut flowers are often combined with potted plants to make the design, to add distinction to the decor of any room. Book also contains many new ideas for horticulture classes for flower shows, and various ideas of other combinations in different and interesting containers.

INTERESTING uses of materials: Have been interested in the shells which have been used on the Suggs yard, 503 N. Miles. Mrs. Suggs told me at the time they were purchased that they were recommended for their coloring, which changes with the seasons. She suggested that I observe them and note the changes. It has been very interesting and at times beautiful. During these busy days when entertaining friends and when coffee is served, save the grounds and add them to the soil of your gardens and flower beds. The grounds are good mulch and are also a stimulant to the growing worms.

One author stated, "There is no greater coffee addict than a worm with coffee nerves." It seems to stimulate them to reproduce at whirlwind speeds. While enjoying the effects of the coffee the worms do a score of beneficial things to the soil and they really congregate wherever the coffee grounds are.

Keep a container to put the coffee grounds in, and when it has been filled scatter the grounds and gently scratch them into the soil. Better still "dump" it into one area and scratch in the coffee in the soil and the worms will have a picnic. This will add friability to the soil. These worms are those which are helpful to the soil and not harmful to plants.

Sincerest wishes are that this will be one of the happiest and most blessed year for one and all Glad.

Casa Ramirez

RESTAURANT

206 N. SCHLEY 364-6791

MEXICAN FOODS

OPEN EVERY DAY EXCEPT TUESDAYS

11 A.M. - 2 P.M. and 5 P.M. - 10 P.M.

Dieter's Enchiladas

Only \$1.25 MONDAY ONLY!

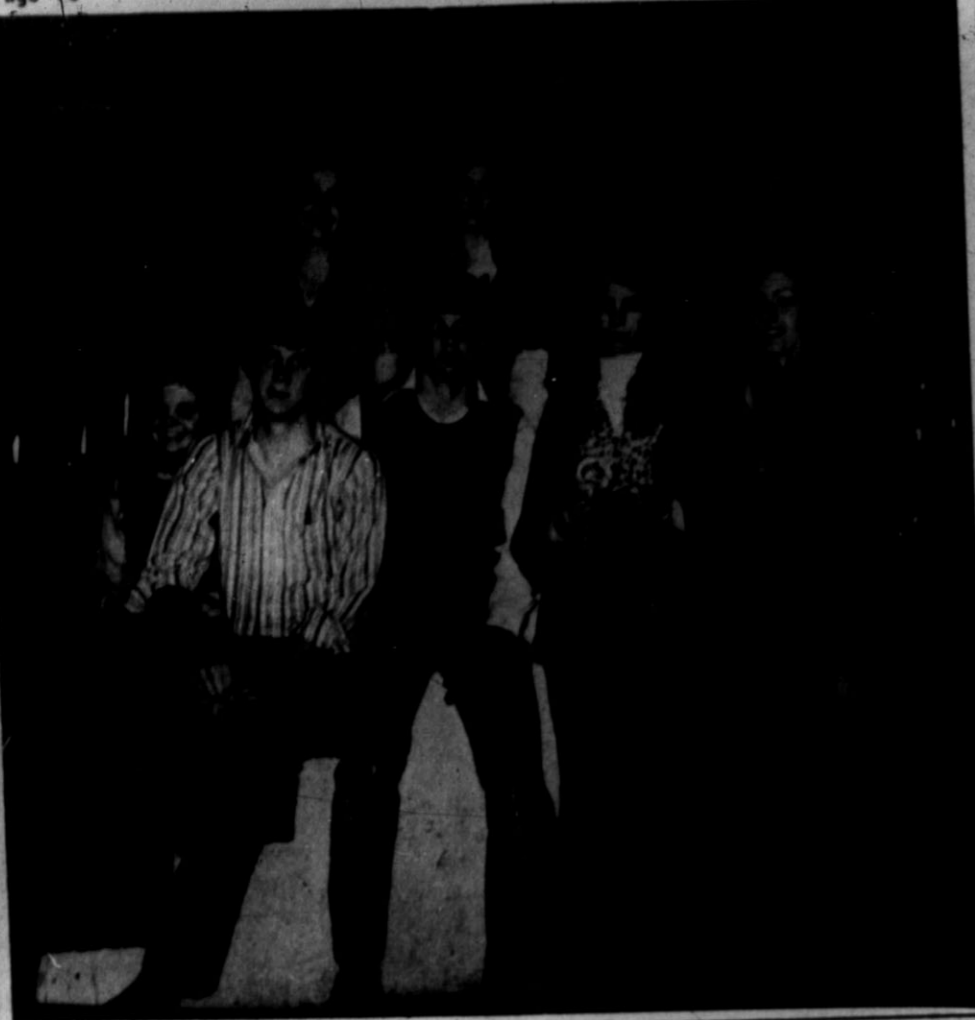

YEARBOOK HONORS announced at Hereford High recently included the Who's Who students at left: Donna Munnerlyn, Dan Vander Zee, Bucky Payne, Denise Strange, Rhea Wesson, Ginger Newton, Layne Young, John Stoy and, not pictured, David Loerwald and Paul Galley. Center photo shows Mr. and Miss HHS—Donna Munnerlyn and David Loerwald. Photo at right shows annual queen Kim Wilson with attendants Jill Stephan and Brenda Owen. Escorts are Steve Jones, Chip Guseman and Mike Munnerlyn.

Winter Wheat Crop Progressing

Generally, seeding of the 1974 winter wheat crop has been completed over the scattered portions of Texas and Oklahoma Panhandles where lack of sufficient moisture has delayed planting. Most of the flood damaged acreage of Kansas and Oklahoma was seeded as fast as fields dried enough to allow reworking of seedbeds and replanting operations. Stands in the early planted areas of the Santa Fe-served states of Colorado, Kansas, New Mexico, Oklahoma and Texas were reported to be good to excellent; however, growth has been slowed in some areas due to lack of moisture in surface soils.

Insects have caused problems in some areas with greenbug infestations in the Texas High and Low Plains necessitating spraying for control with replanting necessary in some fields. Army worms have also been a problem in scattered areas of Texas and Hessian Fly damage is reported in early seeded fields in parts of western Kansas.

Wheat pasture development is behind that of last year in the Texas Panhandle and the western parts of Kansas and Oklahoma. Slower growing conditions coupled with lack of moisture in some areas have produced only limited grazing for livestock. Irrigated acreage is producing food forage and is being grazed in increasing numbers as cattle move from native pastures.

Car Registration Possible Through Mail

OWNERS of some 8.4 million motor vehicles in Texas will have some important mail coming their way early in January.

Registration renewal application will be put in the mail shortly after the holiday season by the Motor Vehicle Division of the Texas Highway Department.

The same quick and easy method made possible by modern computer technology will be in effect this year as it has been in the last few years.

VEHICLE owners can save time that used to be spent waiting in long lines at county tax offices throughout the state by ordering their 1974 license plates by mail.

All that must be done is to send the entire three-part application by mail to the county tax assessor collector in the owner's home county, enclosing the registration fee plus \$1 for each vehicle to cover handling and mailing.

remember:

1. Leave the three-part form intact. Don't separate the three parts.
2. Mail it to the county tax office in your home county. (Mailing it to the Highway Department will only delay getting your 1974 license plates).
3. Be sure to include the registration fee, plus \$1 for each vehicle for postage and handling.

However, county tax offices won't mail plates until after Feb. 1. Owners should allow at least 30 days from the time they apply for the license plates to be returned.

In-person registrations will begin at county tax offices and, in some counties, at substations on Feb. 1. Even though the automated registration application procedures have speeded up the process, waiting lines will grow progressively longer as the April 1 deadline approaches.

ERVIN TO RETIRE

Senator Sam J. Ervin Jr. (D-NC), chairman of the Senate's Watergate investigation, has announced that he will not run for re-election in 1974. He noted that he would be 84 if he served another six-year term.

LAIRD RESIGNS

Melvin R. Laird, President Nixon's chief domestic counselor, has announced his resignation effective February 1. He said that Vice President Ford can and should take over the duties he now performs.

Conspiracy suit against Haldeman blocked.

HEREFORD MONUMENT COMPANY
"YOUR LOCAL MONUMENT DEALER"

UPRIGHT MONUMENTS GRASS MARKERS

MEMORIALS OF EVERY SIZE AND COLOR
CARVED OF THE FINEST STONES REFLECTING
BEAUTY AND DIGNITY AT LOWEST PRICES.
RECEIVE COMPLETE INFORMATION,
PICTURES & PRICES 364-5351

READ BOTH
★ YOUR HOMETOWN NEWSPAPER
★ THE DALLAS MORNING NEWS
COMPLETE NEWS COVERAGE

→ LOCAL • NATIONAL
STATE • WORLDWIDE

SUBSCRIBE TO TEXAS' FIRST METROPOLITAN NEWSPAPER
ONLY \$3.00 A MONTH

The Dallas Morning News
Contact Your Local Dallas News Distributor
Or Fill Out And Mail This Handy Coupon

CIRCULATION DEPARTMENT
THE DALLAS MORNING NEWS
COMMUNICATIONS CENTER
DALLAS, TEXAS 75222

Please start my subscription to The Dallas Morning News at once. I understand that the price is \$3.00 a month.

NAME _____ PHONE _____
ADDRESS _____
CITY/STATE/ZIP _____

THERE ARE three things to

ONE MINUTE SPORTS QUIZ

1. Who won the recent Blue-Grey football game?
2. Who was named golf's Player of the Year?
3. Name the winner of the Liberty Bowl.
4. When and Where is the Super Bowl being played?
5. What sport is Tony Esposito known for?

Answers To Sports Quiz

1. Blue 20-Grey 14.
2. Tom Welskopf.
3. North Carolina State 31, Kansas 18.
4. January 13, 1974 in Houston.
5. Hockey.

ARMY & NERVE GAS

The Army plans to spend at least \$200-million producing a new type of nerve gas for its larger artillery shells. The new nerve gas will be far safer to handle, transport and store.

WHALE OF A CLEARANCE SALE

SAVE \$10 to \$90 NOW!

HUGE SAVINGS OVERSTOCK, SCRATCHED, DENTED, DISCONTINUED ITEMS... SOME ONE OF A KIND.

ELECTRONIC OVEN 25 Min. Timer REG. 344.70 No. 8092 \$229 ⁷⁵ 1 ONLY	12" COLOR TV PORTABLE \$241 ²⁸ AFC CONTROL SLIDE RULE TUNING REG. 255.35 No. 12253	VINYL RECLINER \$59 ¹³ Was 89.13 Used 1 ONLY
ELECTRONIC OVEN REG. 226.75 No. 8093 \$203 ⁷⁵	CANISTER - UPRIGHT VACUUM \$129 ⁸⁸ REG. 144.95	75 QT. ICE CHEST \$12 ⁸⁸ REG. 24.95
TRASH COMPACTOR \$147 ⁰⁰ 3,000 Lbs. of Compression REG. 236.95 No. 5,000	12 CYCLE DISHWASHER \$293 ⁶⁶ Harvest Gold or White Walnut Cutting Board Top REG. 338.73 No. 992	SLEEPING BAGS \$19 ⁸⁸ Daron Filled REG. 29.99
ELECTRIC DRYER - WHITE \$134 ⁰⁰ REG. 189.95 1 ONLY No. 7621	9 CYCLE DISHWASHER \$198 ⁰⁰ REG. 298.95 No. 981 White	Smooth Top Electric RANGE \$381 ⁴⁰ Continuous Cleaning Oven - White REG. No. 4384
ELECTRIC FIREPLACE \$157 ⁴⁵ REG. 187.45	REFRIGERATOR - FREEZER \$273 ³⁶ Avacado or White No. 1593 Built in Rollers Large Freezer REG. 313.36	Gas Continuous Cleaning Over RANGE \$301 ⁴⁰ Warming Shelf Harvest Gold REG. 346.47 No. 2373 20 Lb. 11 Cycle
25" CONSOLE COLOR TV \$513 ²⁸ A/F - AFC - No. 17423 REG. 543.35	17.3 Cu. Ft. REFRIGERATOR - FREEZER \$304 ⁷¹ 166 Lb. Freezer All Frostless White Avacado No. 1733 REG. 354.78	AUTOMATIC WASHER \$225 ⁹¹ Avacado - Great For Knits REG. 315.90 No. 6734
60" CONSOLE STEREO \$326 ⁶⁵ FM, AM, FM STEREO, 4 SPEED TURNTABLE 8 Track Player REG. 367.22 No. 2123	REFRIGERATOR - FREEZER \$369 ⁸⁸ 16.7 Cu. Ft. Side By Side Freezer Holds 191 Lbs. REG. 424.95 No. 1873	CLOTHES DRYER \$198 ⁹⁵ 28 Pounder REG. 219.02 No. 7739
22" BLACK AND WHITE PORTABLE \$154 ⁶³ REG. 184.70 No. 13994	RANGE \$228 ³¹ Gas or Electric Eye Level Oven Walt Level Broiler REG. 298.31 No. 3332/8333	GIFFY VACUUM \$14 ⁵³ REG. 24.60

EVERY APPLIANCE IN THE STORE ON SALE
HURRY! SHOP TODAY!

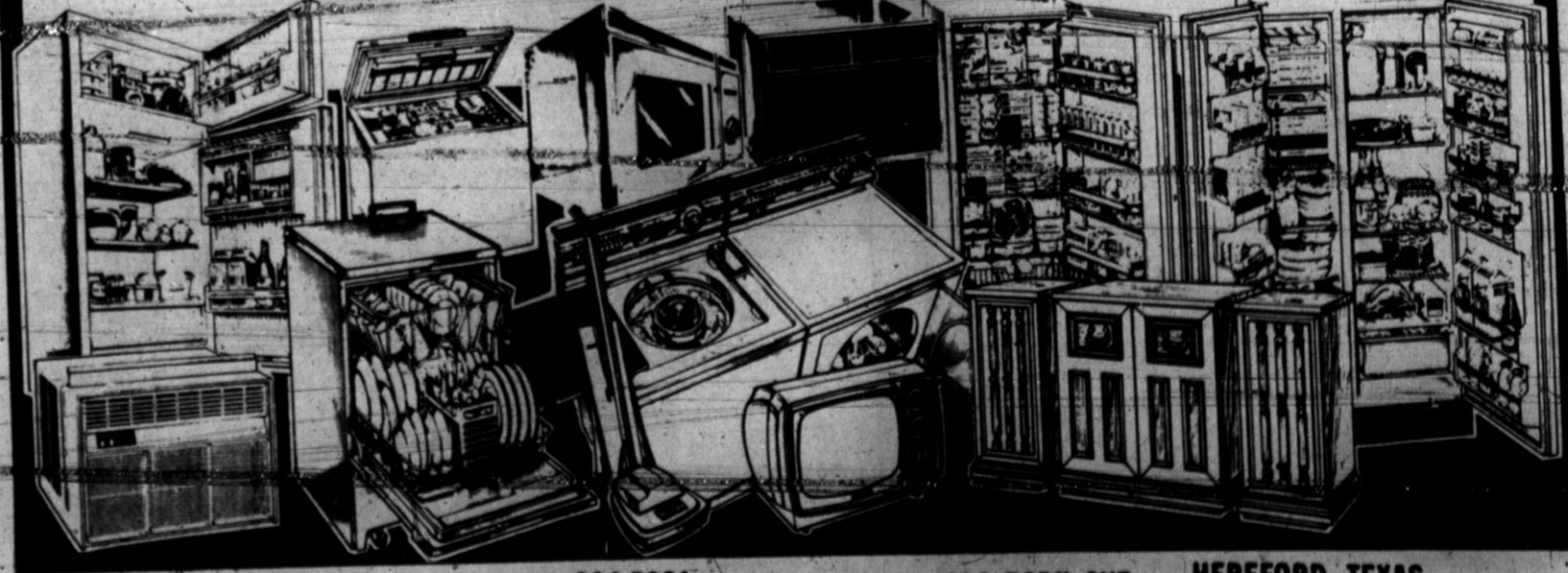

*Plus transportation 364-5801 114 PARK AVE. HEREFORD, TEXAS

for the **HIGHEST EARNINGS**
on your savings see **HI PLAINS**

NOW EARN **5 1/4%** ON PASSBOOK SAVINGS PER ANNUM

UP TO **7 1/2%** ON CERTIFICATES PER ANNUM

Minimum Maturity	Minimum Balance	Rate
6 Months	\$1,000.00	5.75%
1 Year	1,000.00	6.50%
30 Months (2 1/2 yrs.)	1,000.00	6.75%
4 Years	1,000.00	7.50%

Federal regulations require a substantial interest penalty for early withdrawal on certificate accounts.

December 24th 1973

HI-PLAINS SAVINGS

and Loan Association

4th & Sampson, Hereford
An Equal Opportunity Lender

Let's Cook

50-Year Resident Found A Windmill Town Here

By SUE COLEMAN
Women's Editor

IT WILL BE 50 years next March since Mrs. Roy Boyd came to live in Hereford, and she remembers most vividly about the small town that it was then, the many windmills.

"There was a windmill in almost every yard and most people here used water from them instead of from the city water system," she says.

"That good soft water" was one of the things she liked best about her new home, as hard water had been a problem down in the southeast corner of the Panhandle, near the Oklahoma line, where she had previously lived.

She was Eldora Luck when she came with her family to Hereford from Dodson, in Collingsworth County. Born on a farm just across the line near Hallis, Okla., she spent most of her life in the Dodson community where her father operated a blacksmith shop.

BEFORE she finished high school here, she married Roy Boyd in 1926 and they have continued to make their home here, since 1951 in the house at 608 Blevins where they live now.

Boyd is now retired and the couple enjoys backyard gardening as one hobby. He does most of the outdoor work of growing vegetables, and helps harvest them and get them ready for canning or freezing, Mrs. Boyd admits. There are also plum and cherry trees in the yard to supply fruit, but freezes last spring nipped the fruit crop this year.

"We canned nearly everything in the world last summer," Mrs. Boyd says, "and even got peas from the field when we visited my aunt in Oklahoma, and canned them. We have very little freezer space so most of our crop is canned."

SHE LIKES to have the fresh or canned food when her family gathers at home for such occasions as the recent Christmas holidays. One daughter, Royla, Mrs. Earl Glenn of Amarillo, and her three children live near enough that they are frequent visitors.

The other, Barbara, is Mrs. W.D. West of Cleveland, near Houston, and the 600-mile trip from that city is made less often.

There are six grandchildren in all, and one great-grandson. They were all here Christmas except the married grandson and his family. Mrs. Boyd especially enjoys preparing dinners for the whole family.

She has a favorite recipe for a main dish, a different version of the popular chicken-rice which with a fresh salad makes a whole meal.

BAKED CHICKEN AND RICE
2 cups uncooked rice
1 can cream of chicken or chicken-gumbo soup
1 can cream of mushroom soup
1 soup can of water
1 pkg. dehydrated onion soup
A 2 to 3-pound chicken, quartered or cut in pieces

Mix rice, soup and water in greased baking dish. Sprinkle a fourth of the onion soup over this. Place chicken, skin side down, over the mixture. Sprinkle the remainder of the soup over the chicken. Cover with foil and bake at 325 degrees two hours.

TROPICAL APPLE SLAW
Combine 3 cups crisp shredded cabbage, a 9-oz. can pineapple tidbits, drained, 2 cups diced unpared red apples, 1/2 cup chopped celery and 1/2 cup blanched slivered almonds. Mix well and add 1/2 to 3/4 cup mayonnaise. Toss until all ingredients are well coated with dressing. This makes 6 to 8 servings.

QUILT making is a favorite pastime for Mrs. Boyd, and she is making a quilt for each of her grandchildren. She is happy that quilting is becoming a popular handcraft again but she has continued to make quilts when it was not so popular.

Mostly she makes those with appliqued patterns and is glad that sewing machines are now made so the pattern does not have to be applied by hand in the tedious method she once used. She also pieces quilts but not as much as she formerly did.

She enjoys quilting and is sometimes joined by Mrs. Glenn for that part of the work. A member of West Hereford Home Demonstration Club since it was organized when she was a young matron, she is active in its programs. She and her husband also are members of a canasta club which has covered six dinners before its periodic evening games. Her church is Temple Baptist, located near her home.



Mrs. Roy Boyd
half century in Hereford

Small Talk

By SUE COLEMAN
Women's Editor

A COMBINATION of closed gas stations and a West Texas snowstorm seems to be just what the safety experts have been looking for all these years. It does cut down on traffic fatalities during a holiday period, although you might say it does it the hard way.

Another factor in that combination just might be the grid bowl games, televised. No telling how many people stayed home Saturday through Tuesday because they didn't want to miss a minute of the action.

If a lot of them had been out in their cars, as they likely would, have been without the TV games, the weather might have added to the accident total instead of subtracting from it. We analysts who draw conclusions from a given situation gotta look at all the angles, you know.

and the traffic accident situation will take care of itself. Only some bright boy will no doubt come along and invent a way to move cars without gasoline and we will be whizzing around with nuclear power plants (small ones of course) under the hoods and bopping into each other with our usual abandon.

When smart people like me solve a problem one way, it just crops up from another direction. Oh well...

ONE OF MY Christmas letters from a friend with whom contact is maintained through the once-a-year communication, told of her husband's serious illness earlier in 1973.

An ulcer put him on a rest cure, and she said he spent most of his time watching the Watergate hearings on TV and figured he had seen more of the whole thing than anybody else in the country.

It's nice that the television shows served such a good purpose, only if it had been me, they would have given me another ulcer.

By the way, I just got to wondering — does anybody in the audience happen to remember what it was that whoever it was, was looking for when he broke into wherever it was at the Watergate Hotel, that led to all the ramifications that have caused so much trouble to so many people?

AT ANY RATE, even an expert can conclude that traffic accidents drop when the number of cars on the highways drop. Somebody has said something about that sometime before, I think, but so far nobody has done anything about it.

Now the Arabs, the Republicans, the Big Oil Companies, the Environmentalists or the Texas Oil Millionaires, whoever you want to blame, are limiting our supply of gasoline maybe we'll soon be back on our feet again

roast and steaks and beef liver.

"Egg prices also remain steady with eggs getting renewed attention.

"One dozen large eggs weighs one-and-one-half pounds. So even at 90 cents per dozen, they cost only 60 cents per pound. Versatility and preparation ease are two additional factors in their popularity."

Chicken hens also carry reasonable price tags this week, the specialist said. Watch for occasional features on whole fryers and fryer parts.

Citrus Fruits Bountiful

This holiday season finds citrus fruits plentiful.

"The price of navel oranges is coming down, so plenty will be available for holiday eating and giving," Mrs. Gwendolyn Clayatt, consumer marketing information specialist, Texas Agricultural Extension Service, Texas A&M University System, noted.

"Greater supplies of tangelos, tangerines and grapefruit mean lower prices. Lemons also are in plentiful supply—with the new crop coming in from desert areas.

"Other economical produce items include apples, bananas, cranberries, potatoes, cabbage, carrots, celery and mustard greens. Also turnips and greens, corn, dry yellow onions, hard shell squash, cauliflower, broccoli and head lettuce."

Meat prices, on the other hand, remain about the same as a week ago, the specialist continued. At pork counters, look for values on Boston-butt roasts, end chops, rib end roasts, spare-ribs and semi-boneless hams. "Some stores feature beef specials on chuck

AT ANY RATE, even an expert can conclude that traffic accidents drop when the number of cars on the highways drop. Somebody has said something about that sometime before, I think, but so far nobody has done anything about it.

Now the Arabs, the Republicans, the Big Oil Companies, the Environmentalists or the Texas Oil Millionaires, whoever you want to blame, are limiting our supply of gasoline maybe we'll soon be back on our feet again

"MOVE UP TO FORD!"

COME SEE THE NEWEST FOR

1974

GALAXIES, LTD'S, LINCOLNS, MERCURY, FORD PICKUPS

FORDS! FORDS! FORDS!

If You Didn't Buy it From...

ORVAL WATSON FORD SALES

You Paid TOO MUCH!

200 W 1ST 364-2727

STOP IN OR CALL WARDS AUTOMOTIVE CENTER!

114 PARK AVE.
364-5801
HEREFORD, TEXAS

WARD'S

BATTERIES
INSTALLED
FREE

WARD'S BATTERY PROTECTION PLAN

Wards Battery will replace the battery of an car for the original owner if a fault is accepted and liable charge is non-commercial passenger car use during 12-month Free Replacement Period. After this period, to the end of its 42-month guarantee period, Montgomery Ward will replace the battery, charging price the battery, including price the current regular selling price has made in batteries in commercial use are guaranteed in a similar basis for one-half of the specified period. Commercial use is defined as use in any vehicle for other than family or personal use for service under the guarantee, return battery with evidence of date of purchase to any Montgomery Ward branch.

SAVE \$6

OUTSTANDING VALUE!

GET AWAY 42-MO. BATTERY GIVES YOU MORE

Polypropylene case has more room than rubber cases, holds more plates, power. More power for sure starts—up to 410 cranking amps. And a 1-yr. free replacement period! For most cars.

2188

EXCH. REG. 27.95 EXCH.

9.99 DELUXE BRAKE SHOES

3-WHEEL SET EXCH. **7.47**

Delivers good, reliable stopping power you need at this low economy price.

31.98 AUTOMATIC 8-AMP CHARGER

12-VOLT **24.88**

Charges 12V batteries in 3-6 hrs. Turns on, shuts off when needed.

SAVE 44%

2.98 WARDS IGNITION TUNE-UP KITS

MOST U.S. CARS **1.66**

Tungsten points, moisture-proof condenser, corrosion-proof rotor.

GIGANTIC TIRE SALE!

POLY-TRACK HIGHWAY HANDLER

8.95

BUYS YOUR 2ND B78-13 TBLS. BLK. WHEN YOU BUY 1ST AT REG. PRICE PLUS 1.81 F.E.T. EA. AND TRADE-IN

- 4 full plies of popular polyester cord offer durability, help curb cold-morning thumping for quiet riding comfort
- Modern 78-series profile and wide 7-rib design to give you stability
- Wraparound tread for good cornering

TUBELLESS SIZE	REPLACES SIZE	REGULAR PRICE EA. BLACKWALL*	SALE PRICE 2ND TIRE*	REGULAR PRICE EA. WHITEWALL*	SALE PRICE 2ND TIRE*	PLUS F.E.T. EACH
B78-13	6.50-13	\$18	8.95	\$21	11.95	1.81
C78-13	7.00-13	\$20	11.95	—	—	1.93
B78-14	6.45-14	\$22	12.95	\$25	18.95	1.96
E78-14	7.35-14	\$23	12.95	\$26	18.95	2.22
F78-14	7.75-14	\$25	14.95	\$28	17.95	2.37
G78-14	8.25-14	\$28	15.95	\$31	18.95	2.53
H78-14	8.55-14	—	—	\$35	19.95	2.75
F78-15	7.75-15	\$26	15.95	—	—	2.42
G78-15	8.25-15	\$29	16.95	\$32	19.95	2.60
H78-15	8.55-15	\$32	17.95	\$35	20.95	2.80

*With trade-in tire off your car.

FAST, FREE MOUNTING!

PRICES SLASHED! \$21 to \$38 OFF IN PAIRS — WARDS WTO RADIAL

LOW AS **2 FOR 6720**

E78-14 TBLS. WHT. PLUS 2.70 F.E.T. EA., TRD.

- 4 rayon belts fight puncture and squirm
- 2 radial rayon plies let tread stay flat for controlled performance

TUBELLESS WHITEWALL	REGULAR PRICE	SALE PRICE	PLUS F.E.T.
E78-14	\$28	\$25	1.96
F78-14	\$30	\$27	2.00
G78-14	\$32	\$29	2.04
H78-14	\$34	\$31	2.08
E78-15	\$36	\$33	2.12
F78-15	\$38	\$35	2.16
G78-15	\$40	\$37	2.20
H78-15	\$42	\$39	2.24

*With trade-in tire off your car. Because of their unique design, radial ply tires must be mounted on all 4 wheels.

SELL IT FAST! BUY IT RIGHT! USE WANTADS!

Phone 364-2030

CLASSIFIED ADVERTISING RATES
 Readers Ads (Minimum 10 words) 1st insertion per word 10c
 Additional insertions, when paid in advance: per word 8c
 Classified Display (8 pt. type under a specific heading, 1 column width, only — no art or signature cuts) per col. inch \$2.00
 Repeat insertion without copy change per col. inch \$1.50
 Display Advertising Not Classified under a heading, but placed on the classified page per col. inch \$1.54
 Deadline for Classified Advertising in the SUNDAY BRAND. 5 p.m. Friday

Deadline for Classified Advertising in the HEREFORD BRAND. 5 p.m. Tuesday

1. FOR SALE Miscellaneous

TOWN & COUNTRY MOBILE HOME SALES
 Hwy 60 & MYRTLE
 Phone 364-0169
 Also spaces & furnished trailers for rent at TOWN & COUNTRY ESTATES
 IB-1-23-9p

"THE SADDLE HOUSE" COMPLETE Riding Equipment
 New & Used Saddles
 HIGGINS & SOUTH TEXAS ST.
 PHONE 364-3583
 IB-1-3-11c

"CARPET!" Financing Available!
 CAV CARPET
 PLAINS AND N. 35 MILE AVE.
 PHONE 364-3488
 B-2-16-11c

WE BUY AND SELL USED FURNITURE BARRICK FURNITURE WEST HWY 60 PHONE 364-3552
 IB-37-4fc

GARAGE EQUIPMENT NEW & USED
 Air Compressors, Valve Machines, Steam Cleaners, etc.
BOYD MACHINE & SUPPLY
 1306 East Park
 Phone 364-1055
 IB-1-9-11c

RCA WHIRLPOOL commercial ICE MAKERS — Sales and Service — Brown Sheet Metal
 B-1-11-52-1fc

FOR SALE
 1-21" Color Console TV 1-19" B&W Portable
WE MAKE HOUSE CALLS
 Repairs on all makes & models, color, B&W and radios.
TOWER TV
 248 Northwest Drive
 Phone 364-4740
 B-1-35-4fc

New Singer Dealer in Hereford. Sewing machines and vacuum cleaner repair. All makes. Free estimate in advance. Work done by Singer trained mechanics. Scissors sharpened. Call 364-4051. Sanders Sewing Machine Center, 226 Main, Hereford.
 B-1-4-14fc

For Sale: 250 small beef type calves. Call Pete or Terry Caviness, 364-4900.
 B-1-12-51-4c

STATED MEETING
SECOND MONDAY
 7:30 P.M.
 Thursday
DEGREE WORK
 Charita Brown W.M.
 W.A. Phipps Sec.
 Hereford Rotary Club
 meets every Monday at 12:05
 Civic Club Center (Jim Hill)
 Lions Club meets each Wednesday, 11 Noon
 Civic Club Center (Jim Hill)

FOR SALE: AKC Registered Wire Fox Terrier Puppies. Six Weeks Old. Call 364-0199.

FOR SALE
 Registered Apaloosa horses. Bred Apaloosa fillies, Apaloosa Stallion — 10 years old and gentle to ride and a good cow horse (Grandson of Whistle Breeches)
 J.A. Crofford
 Phone 364-0952
 B-1-20-11c

Oak firewood for sale: 209 Kibbe. Call 364-6919.
 B-1-10-26-2p

LEFT IN LAY-AWAY
 Electrographic Component Stereo with built-in tape player. AM-FM Multiflex Radio. Garrard Turntable, 200 watts, 10 speaker. Original price \$399.95. Assume balance of \$245.00 or \$10.00 monthly payments
 at
MARTINS SOUND CENTER
 Corner of Georgia & I-40 in Wolflin Square, Amarillo
 B-1-31-11c

KIRBY VACUUMS
 Rebuilt with genuine Kirby parts.
 \$69.95 & up.
 2 year guarantee
 Your only authorized Kirby Distributor.
 Kirby Sales & Service
 522 Irving
 Phone 364-0422
 B-1-35-4fc

WATER BEDS
 Southwest Carpet, 209 Park Avenue. Phone 364-1763.
 B-1-41-11c

See Our Line Of Bargains On new and used furniture and appliances
 Open week days 9 to 12, 1 p.m. to 6 p.m. Sat. 8 to 8
BIG JIM'S FURNITURE
 Higgins & So. Texas St.
 Phone 364-1873
 B-1-19-11c

Fireplace wood for sale. Call 364-2111.
 B-1-10-46-11c

For Sale: Westinghouse built-in dish washer-harvest gold. \$75.00. Phone 364-2520.
 B-1-11-48-11c

For Sale: White German Shepherd Puppies. Perfect Christmas gifts. Call Johnny Rickman 276-5822.
 B-1-12-30-11c

FOR SALE:
 1-Heiser Broncho Riding Saddle.
 1-Big sorrel mare, gentle enough for anyone to ride who can pull back on the reins and say WHOA.
THE SADDLE HOUSE
 Higgins & South Texas
 Phone 364-3583
 B-1-27-11c

For Sale: Two registered male beagles. Phone 266-3337.
 B-1-27-11p

To give away black and white cdlie pups.
 309 Sunset
 B-1-10-27-2c

NEW FURNITURE
 Stereo Console with China Hutch, reg. \$499.95, now \$399.95.
 1-Quadraphonic Component set, reg. \$525.95, now \$469.95.
 New living room suits as low as \$179.95.
 New recliners as low as \$79.95.
PLAINS
FINANCE CORPORATION
 906 So. 25 Mile Avenue
 Phone 364-3400
 B-1-40-11c

For Sale: English Pointer Pups. Good breeding, 8 weeks old. Females \$35.00, Males \$60.00. Call 364-6800.
 B-1-16-27-2c

FULLER BRUSH PRODUCTS.
 Good personal service. Mrs. Jessie Fuller, 258-7228.
 S-1-27-4fc

THE amazing Blue Lustre will leave your upholstery beautifully soft and clean. Rent electric shampooer \$1.
 Hereford Hardware
 B-1-19-27-2c

For sale: Zenith color TV, Early American console, maple twin bed with mattress, box springs. 289-5810.
 B-1-16-24-11c

For Sale: 1971 Honda. \$200.00. Call 276-5821 after 5:00 p.m.
 B-1-10-49-11c

1972 Kawasaki Racer, 250 cc. Good condition. Call 357-2344.
 B-1-10-23-11c

For sale: Packard-Bell coffee table stereo. Call 364-0700; 364-2707 after 5:00 p.m.
 B-1-12-25-11c

Model 12 Winchester, 3" mag. \$140.00. 788 Remington, 243 Cal. with 3 to 9 variable scope. \$85.00.
 Call 289-5951
 B-1-19-25-11c

1/2 price sale — jeweled Christmas kits, tree skirts, stockings, ornaments, card holders, toys. Needlepoint tapestries.
 Dan's of Canyon
 B-1-18-51-6c

HAYGRAZER Heavy grain, 4000 bales. Johnson grass, 3500 bales. \$50.00 per ton. 364-0484
 B-1-51-4c

CAKETS a fright! Make them a beautiful sight with Blue Lustre. Rent electric shampooer \$1.
 McCaslin Lumber
 B-1-19-12-2c

Oak fire wood for sale. Phone 364-5264 after 5:00 p.m.
 B-1-10-1-11c

For Sale: 4 months old Brittany Spaniel Puppies. Registered AKC. Call 364-1717.
 B-1-12-1-11c

For Sale: Used gas dryer. Excellent condition. Call 364-5746 after 6:00 p.m.
 B-1-11-1-11c

For Sale: Go-Kart-McCullach Powered. Call 364-5780 after 4:00 p.m.
 B-1-10-1-11c

GARAGE SALE Wednesday through Saturday. Large sizes men-women clothes, mini-bike, misc. One Block West of Big Daddy's. Mrs. J.F. Messer.
 B-1-1-11p

BE gentle, be kind, to that expensive carpet, clean it with Blue Lustre. Rent electric shampooer \$1.
 Duckwalls, Sugarland Mall
 B-1-21-1-2c

REPOSESSION
 \$14,950.00 — 3 bedroom, 1 1/2 baths, attached garage, carpeted, built-in range. Total move-in cost less than \$500.00.
 437 AVENUE C
 Move in cost less than \$500.00. New FHA Loan.
 5 UNIT APARTMENTS
 Good location, good income.
LOANS
 Let us help you with your financing FHA-VA & CONVENTIONAL LOANS are now available. Check with our office for details.
TWO BEDROOM
 Carpeted with finished room and garage. Fenced yard. \$9,500.
THREE BEDROOM
 Carpeted, double car garage. On Labor Camp Road. \$9,900.
Beard of Realtors
 Multiple Listing Service
CARTHEL REAL ESTATE
 206 N. 25 Mile Avenue
 Phone 364-0944
 364-0938
 Wayne Carthel
 Leola Peters
EQUAL OPPORTUNITY
 B-4-10-11c

For Sale: Oswalt Manure Excellent condition. Call 806-249-2242 or nites, 806-249-2247.
 B-2-13-51-11c

For Sale: 1971 Honda. \$200.00. Call 276-5821 after 5:00 p.m.
 B-1-10-49-11c

1972 Kawasaki Racer, 250 cc. Good condition. Call 357-2344.
 B-1-10-23-11c

3. FOR SALE Automobiles

1971 Ford, 1/2 ton. Power & air. 40,000 miles. New steel belted tires. Sale or trade for older pickup. Call 364-3484.
 B-3-21-48-11c

MILBURN MOTOR COMPANY
 We pay cash for Used Cars
 136 Sampson
 Phone 364-0077
 B-3-33-11c

Going overseas — must sell 1973 Cutless Supreme maroon and white Olds. Bucket seats, automatic transmission, factory air, low mileage. Call 364-1110 or 364-1302.
 B-3-23-51-11c

WALKER'S USED CARS AND TRUCKS
 WE BUY, SELL OR TRADE
 400 West First
 Phone 364-2250
 IB-41-11c

SELECTED USED TIRES
 \$3.00 UP
 30 Day Guarantee
MONTGOMERY-WARD AUTOMOTIVE SALES
 114 EAST PARK
 IB-3-17-11c

NEW & USED CARS
ORVAL WATSON FORD
 PHONE 364-2727
 IB-3-18-11c

Used Chevy Pickup for sale. See at 515 Avenue K or call 364-0210.
 B-3-13-27-2c

1971 Ford 1/2 ton Pickup, V8, Automatic, excellent condition. Phone 364-5324 after 7:00 p.m.
 B-3-13-27-3c

1967 Chevy 2, six cyl. Call or come by, 364-1170, 904 E. 3rd.
 B-3-12-1-11c

4. REAL ESTATE For Sale Or Trade
 For Sale By Owner
 Large double wide mobile home. 24x50. 3 bedrooms, 1 1/2 baths, large lot 65x119. 6 ft. fenced backyard with fruit trees, patio, 11x11 playhouse, wood burning fireplace, gas grill and light. Priced to sell.
 Call 364-3423
 B-4-30-11c

LAND
 60 acres with a well. Good farmland, at \$325.00 per acre.
 Carthel Real Estate
 Phone 364-0944
 B-4-43-11c

I have Farm and Ranch Buyers, I need your listings.
J.M. HAMBY REAL ESTATE
 Phone 364-3566
 Res. 364-2553
 B-4-29-11c

WANT A GOOD INVESTMENT?
 This duplex on 3rd Street is furnished and is in good shape inside and out. Priced at \$15,000.00 and you can buy this one for \$2,000.00 down and \$125.00 per month. It is rented for \$160.00. How can you lose?
 2 bedroom, 1 bath, new carpet, fenced yard. Right for a couple who are wanting to get a start in life. Buy equity and assume payments at \$96.00 per month.
1.7 ACRES OVER-LOOKING GOLF COURSE
 Ideal for nice mobile home spaces or for a nice apartment house. 2 bdrm. rent house goes with land. Priced for \$16,000.00. Terms available.
1600 ACRES.
DEAF SMITH COUNTY
 Approx. 550 acres cult., 7 small irr. wells, ideal cattle operation. Price \$157.50 per acre. Terms available.
 We have some small tracts and some farms for sale. If you don't find the home or farm you need, we may have it or can find it for you.
HAMBY REAL ESTATE OFFICE
 Calvin Edwards — 364-3566
 Gerald Hamby — 364-1017
 Chick Weemes — 364-3109
 364-2553
EQUAL HOUSING OPPORTUNITY
 B-4-27-11c

For Rent: 3 room house, partially furnished. Call 364-4917 after 4:00 p.m.
 B-5-27-2p

For Rent: Trailer space at 217A Avenue A. Paved street and drive. Phone 364-4553.
 B-5-14-27-11c

For Rent: 3 room house, partially furnished. Call 364-4917 after 4:00 p.m.
 B-5-27-2p

For Rent: 3 room house, partially furnished. Call 364-4917 after 4:00 p.m.
 B-5-27-2p

For Rent: 3 room house, partially furnished. Call 364-4917 after 4:00 p.m.
 B-5-27-2p

For Rent: 3 room house, partially furnished. Call 364-4917 after 4:00 p.m.
 B-5-27-2p

For Rent: 3 room house, partially furnished. Call 364-4917 after 4:00 p.m.
 B-5-27-2p

CLOSED ON SUNDAYS

"Yes, we're open on Sundays — that's just the title of this week's show."

"Yes, we're open on Sundays — that's just the title of this week's show."

LET'S MAKE A DEAL
 on this 3 bdrm. 2 1/2 baths, carpet, built-ins, utility room, double garage. This home is about 3 yrs. old and has an isolated master bedroom. Priced \$18,500.00 with \$1,000.00 down.
 B-4-15-23-11c

CLOSE TO SCHOOL & SHOPPING CENTER
 3 bdrm. 1 1/2 baths, single garage, all built-ins. Buy equity and assume payments of \$151.00 per month.
 B-4-10-44-11c

ONE OF THE PRETTIEST ON MIMOSA STREET
 3 bdrm. brick 2 1/2 baths, den and kitchen comb. dining room, living room, ref. air, 2 fireplaces, \$2,000.00 worth of drapes. Double garage with electric door lift. Built-in vacuum cleaner, patio with bar-b-que grill, gas lights front and back. 5% per cent loan. Buy equity and assume payments of \$236.09 per mo.
 B-4-19-1-11c

MOBILE HOME SPACE for rent. Call 276-5333.
 B-5-10-3-11c

TRAILER SPACE FOR RENT
 Northwest Mobile Lodge,
 Phone 364-1108
 B-5-10-13-11c

BEDROOMS BY THE WEEK
 Plains Motel.
 B-5-23-9p

Small two bedroom, trailer house for rent. Phone 364-4533 or 220 North 25 Mile Avenue.
 B-5-15-27-11c

For Rent: 3 room house, partially furnished. Call 364-4917 after 4:00 p.m.
 B-5-27-2p

For Rent: Trailer space at 217A Avenue A. Paved street and drive. Phone 364-4553.
 B-5-14-27-11c

APARTMENTS, FURNISHED
 1 and 2 bedrooms with kitchen, dinette and bath. Also 2 bedrooms, living room, kitchen, dinette and bath.
FORREST AVENUE APARTMENTS
 Phone 364-1887
 IB-5-4-11c

FURNISHED one and two bedroom apartments. Inquire 112 Avenue H, Apt. 36.
 B-5-12-46-11c

Unfurnished one bedroom duplex. Bills paid, couple only, no pets. References needed. Phone 289-5757.
 B-5-14-48-11c

SUMMERFIELD MOBILE MANOR
FIRST MONTH FREE. 7 miles West on Hwy. 60. Phone 357-2552.
 B-4-15-10-11c

OFFICE FOR LEASE Ralph Owens 364-2222.
 IB-5-10-14-11c

Office for rent. Answering service available. **AGRI-SCIENCE CENTER**, 1500 West Park, Phone 364-5822.
 B-5-14-19-11c

Thunderbird Apartments. Unfurnished 2 bedroom, 1 1/2 bath. Phone 364-5360.
 B-5-13-19-11c

For Lease: Old Lockwood Grader Building. Contact S.T. Wiseman 364-1752 or 258-7245 or Leroy Williamson, 364-1933.
 B-5-14-51-11c

Storage for rent. Phone 364-1483 or 364-3987.
 B-5-10-50-11c

DIAMOND VALLEY MOBILE HOME PARK
 600 & 700 Block Avenue H, Sioux & Cherokee, 700 Block Avenue G.
 Phone 364-1483 or 364-3987
 B-5-50-11c

For sale, by owner: large 2 bedroom house, very large double garage. Well insulated, low gas consumption. Phone 364-2510.
 B-4-19-24-11c

WHY PAY OUTRAGEOUS PRICE FOR YOUR APARTMENT?

We have apartments to suit your needs in any size. Your rent is adjusted to your income, so you will not be paying more than you can afford. Apartments have stove, refrigerator, garbage disposal, central heat and air and fenced playgrounds, laundry facilities, recreation room, tree cabre view.
 1 bedroom start \$79.95
 2 bedrooms start \$101.35
 3 bedrooms start \$113.75
 4 bedrooms start \$132.00
 All bills paid. Deposit is required.
BLUE WATER GARDEN
 412 Irving
 Phone 364-4441
 B-5-1-10c

FOR LEASE OR SALE

Commercial building (8,000 sq. ft.) Prime location, corner Main and 2nd St. Hereford, Texas. Priced to sell (Financing available at 7 1/2 per cent). Call Collect for details:
 Geo. Masso
 512-682-6191 or
 512-682-8091.
 B-5-1-10c

For rent: 3 bedroom house 2 miles out. Call 364-0669.
 B-5-1-1p

For rent: 3-4 bedroom house one-half block from Alkman School. \$185.00 per month; one month in advance, \$150.00 deposit. Phone 364-0128.
 B-5-22-1-2c

6. WANTED

CONTRACT GROWERS WANTED
 Must have 10-50 acres irrigated land. Grow new high volume, high protein forage for feed and seed. \$3,000 to \$15,000 investment for earning potential of \$50,000 to \$100,000.
 Write Box 3284
 Arlington, Texas
 Phone 817-274-3003
 (Sunday-Friday)
 B-6-50-9c

Want to buy: Sugarbeet equipment — planter, thinner, harvester, cultivator. Write Richard K. Lackmann, Rt. 1, Moorhead, Minn. 56560.
 B-6-16-61-4c

Want to buy: Pellet mill and batch mixer operators. Experience preferred, but not required. Apply in person or call Hi-Pro Feed, Friona, Texas 806-247-2791.
 B-6-25-25-5c

Couples work together building a business. Start part time and grow. We train. Phone for interview, 364-2229 after 6:00 and weekends.
 B-6-21-26-4fc

Need farm hand. Must be able to irrigate and handle tractors. Call George Ritter, 289-5826.
 B-6-14-26-3c

NEED PAPER BOYS
 APPLY AT
THE HEREFORD BRAND
 B-8-44-11c

MISSOURI BEEF PACKERS, INC.
 is now accepting applications for female production workers. No experience necessary, but must be willing to learn and work. This is year around employment, not seasonal. We offer:
 +Paid vacation
 +Paid holidays
 +Company paid group hospital insurance
 +Good wages
 Apply at Personnel Office of Missouri Beef Packers, Inc. Friona, Texas, 4 miles West of Friona on Hwy 60.
 We are an equal opportunity employer.
 3B-8-14-11c

AVON
GOT A STACK OF CHRISTMAS BILLS? Start earning that extra cash as an Avon Representative! You can make money in your spare time by selling quality products on a flexible schedule. Call today for more details: 364-5160 or 364-0640.
 B-8-27-2c

Seamstress wanted. Experience preferred, but not necessary. Phone 364-5951 or 364-4908.
 B-8-11-27-2c

Millwright to finish feed mill and operate. Good salary, bonus. Phone 806-364-0491.
 B-8-51-4c

Need experienced irrigator farm hand. Prefer man 22 to 40 years. House furnished. Call 276-5235 or 276-5251.
 B-8-17-51-4c

FREIGHTLINER DRIVER.
 \$250.00 per week. 10 years California long haul required.
 B-8-51-4c

9. SITUATIONS
 Baby sitting in my home. Will give TLC. 238 Hickory. 364-4268.
 B-9-11-51-11c

MISSOURI BEEF PACKERS INC.

is now accepting applications for beef luggers, production workers, maintenance men and kill floor personnel.
 We offer:
 +Year around employment
 +Paid vacations
 +Paid holidays
 +Company paid group Hospital insurance
 +Good wages
 +No experience necessary
 Apply at Personnel Office of Missouri Beef Packers Inc., Friona, Texas, 4 miles West of Friona on Hwy. 60.
 We are an equal opportunity employer.
 B-8-39-11c

Hide room labor wanted.
 We offer:
 +Good pay
 +Paid vacation
 +Paid hospitalization
 Colorado By-Products
 3 1/2 miles West Hwy 60
 Phone 276-5331 days,
 364-2495 nites
 B-8-42-11c

Need man experienced in farm work with small family. Good salary and housing. Call 295-3432.
 B-8-15-51-4c

WANTED - FARM MANAGER
 250 acres irrigated, mostly alfalfa. Bilingual. Agricultural degree or equivalent. Excellent opportunity for person willing to assume complete responsibility. 506-67-2503.
 B-8-51-4c

We have openings for pellet mill and batch mixer operators. Experience preferred, but not required. Apply in person or call Hi-Pro Feed, Friona, Texas 806-247-2791.
 B-6-25-25-5c

The Hereford Brand, Hereford, Texas, January 3, 1974
 Will do baby sitting in my home. Nice neighborhood. Drop-ins welcome. 364-2135. B-9-13-27-4c
 Baby sitting in my home. Phone Alice Gilleland, 364-4175. B-9-10-26-1fc

WANTED: Baby sitting. Call 364-2149. B-9-10-23-9c
 State Licensed Child Care For Working Mothers Hereford Day Care Center 364-1283 B-9-46-1fc

10. NOTICE
 For the convenience of you, our customers, we now have truck scales to weigh your scrap iron - One mile North of Big Daddy's Truck Stop. HEREFORD IRON & METAL North Progressive Road by City Dump Anson A. & June Dearing Phone 364-3350 or 364-3777 1/2 B-10-34-1fc

ALCOHOLISM INFORMATION
 For information on alcoholism, referrals for help, counseling, or programs on the subject of the disease of alcoholism, Call 364-4540 from 8:00 a.m. 'till 12, 1:00 p.m. until 5:00 p.m. Monday through Friday. A UNITED FUND AGENCY B-10-12-4fc

ENROLLING NOW FOR LESSONS IN OIL PAINTING Beginning JANUARY 14th Small classes, Individual attention PETERSEN STUDIO Phone 364-3198 B-10-1-4c

11. BUSINESS SERVICE
 AAA WRECKER SERVICE HEREFORD WRECKING COMPANY Day Phone 364-4300 NIGHTS 364-4007 and 364-0975 7-11-39-1fc

APPLIANCE REPAIR We repair all makes and models of appliances. All work guaranteed. MONTGOMERY WARD & CO. 114 East Park Phone 364-5801 B-11-52-1fc

JIM MANNING PLUMBING is back and ready to do your job - large or small. Phone 364-0931 We specialize in repairs B-11-27-2c

DON'T TOSS IT - REGLOSS IT. Furniture repaired and refinished. Call Tom Tompkins, 806-267-5831 collect. B-11-27-100
 Tree Trimming and Topping. Call Cliff's Tree Service 364-2111. B-11-10-46-1fc

B.L. JONES CONCRETE CONTRACTOR We will do your finishing or give you a 'turnkey job'. Free Estimates. 246 18th Street Phone 364-6617 B-11-21-1fc

DICKEY'S DOZER SERVICE Dirt Work - All Kinds Bull dozers - Scrapers uck Hoe - Dragline Motorgrader See or Call FLOYD DICKEY S.E. 4th & Belsher Dimmitt, Texas Business Phone 647-4553 Residence Phone 647-4565 B-11-29-4fc

WILL PICK UP JUNK CARS. FREE. Call 364-3350 or 364-3777 B-11-28-1fc

HOME APPLIANCE REPAIRS Guaranteed work on all makes and models. 10 years experience. Available for night-time emergencies. JOE'S HOME APPLIANCE REPAIRS 343 N. Main Ph. 364-5751 B-11-45-1fc

KIRBY VACUUMS Rebuilt with genuine Kirby Parts. \$59.95 & up, two year guarantee. Your only authorized Kirby Distributor. Kirby Sales & Service 522 Irving Ph. 364-0422 B-11-35-1fc

FRANK WESTER CEMENT CONTRACTOR 167 BRADLEY Residential-Commercial Turnkey job Straight finish Phone 364-5189 1B-11-30-1fc

CUSTOM GRINDING New Moellor Tub Grinder. Burrs, baled hay, ear corn, grain, manure. Call Russ Henninger, 806-376-9702 1B-11-23-9p

WANTED 100 to 150 watches a week to repair by latest approved methods. COWAN JEWELERS B-11-15-29-1fc

DRAGLINE SERVICE TAILWATER PIT CLEANING DUMP TRUCKS \$30 ton crane. BOBBY GRIEGO Day Phone 364-4574 Night - 364-2322 1B-11-14-1fc

KELLY ELECTRIC DOUG AND VIRGIL Electrical Contractors Residential Commercial All bids and wiring Call bids and wiring competitive. Phone 364-1345 Night phone 364-2012 or 364-1345 Box 130 B-11-46-1fc

13. LOST & FOUND
 LOST: Drawers from an antique chest. Reward. Call collect - Plainview 293-3963. B-13-11-27-2c
 STRAYED: Two steers or heifers from Northwest of Hereford. Branded "D7" on right leg, yellow tag in right ear. Call 364-6399 or 278-5857. B-13-23-27-3c

LOST: German Shepherd Dog. Tan head and chain collar. Answers to "Tramp". Reward. Call 364-1779. B-13-15-27-3c

CARD OF THANKS The family of Ervin Robinson, Sr., wishes to express their gratitude and appreciation to the many who called, brought food, sent flowers and made donations to the Heart Fund and the Cancer Fund. Our special thanks to the Police Night dispatcher, the patrolman who responded so rapidly and the men on the emergency unit. The Family of Ervin Robinson, Sr.

After Husband-What is left of a sweetheart after the nerve has been killed. -Quonset Scout.

Do They? Achievements are like trousers - they become threadbare if you rest on them. -Sunshine Magazine.

Safest The safest rule for predictions is to be indefinite about the date. Sooner or later almost anything can happen. -Labor.

Reservations Needed In Some Parks
 Need to reserve a cabin, lodge room, shelter or group facility in a state park for, say, Memorial Day next year? Better get your name in to the park superintendent between Jan. 1 and 10 because the Parks and Wildlife Department is holding a drawing at 10 a.m. Jan. 11 in the respective parks to set reservations for high-use days during the coming year. Parks and Wildlife Department officials say that only cabins, lodge rooms, shelters and group facilities may be reserved. Campsites and trailer spaces in state parks may not be reserved but are continually available on a first-come, first-served basis. Those wishing to participate in the Jan. 11 drawing must submit their reservation requests to the park superintendent where the facility is desired. Reservation requests will not be accepted by the department until Jan. 1. Additional dates should be indicated in the order of preference to insure a greater chance for obtaining a reservation. Requests for cabins must include the total number of persons in the immediate

family who will occupy the cabin. Children under six years of age need not be included. In the event one cabin will not accommodate the number of persons in the immediate family, two cabins will be reserved with the participant's permission, provided an adult occupies the cabin with the minor children. A deposit - check or money order - in an amount equal to one day's fee must accompany reservation requests. Participants in the drawing will be notified after Jan. 11 if their reservations have been confirmed. If not, the deposit will be returned. After Jan. 11, reservations for cabins, lodge rooms, shelters and group facilities will be made on the usual first-come, first-served basis.

Bad Company It's no wonder the underworld is so rotten when you observe the kind of important citizens it pals with. -Record, Chico, Calif.

Highway Missile He who travels over 60 miles an hour is not driving his car - he's aiming it. -News, Dallas.

Retirement Incomes Rise In Deaf Smith County

The number of Deaf Smith County residents who are getting Social Security checks each month from Washington continues to rise. And the amounts that are going to them are increasing as well. The latest upward revision, just acted upon by Congress, will boost their payments by 11 per cent during 1974. A total of 1,915 persons in the local area, more than ever before, are now on the receiving end. Three years ago there were 1,663.

THEY ARE benefitting from the contributions they made to the Social Security Trust Fund over the years via money deducted from their pay envelopes. The majority of the recipients are retired workers. The others include disabled workers, widows, children and other dependents. The facts and figures are contained in the latest annual report of the Social Security Administration.

THEY SHOW that the increase in the number of beneficiaries has been due, chiefly, to periodic revisions of the law. The changes have had the effect of bringing more and more people under coverage. Nationally, as a result, more than 9 out of 10 working and people now have Social Security protection. Along with the increase in the number of persons enrolled has been the big increase in the size of pension checks.

IN DEAF Smith County, the average annual payment per recipient was \$1,403 in the past year, considerably more than

the \$851 paid three years ago. The combination of more beneficiaries and bigger checks has boosted considerably the inflow of cash to the local area. The government's figures show that overall payments to local residents, as of the beginning of this year, were at the annual rate of \$2,688,000. Three years before, by way of contrast, the total was only \$1,416,000.

THE RISE, 89.8 per cent, tops the United States rise of 81.3 per cent and the West South Central States' 80.9 per cent. To help pay for the 11 per cent hike in benefits that will be go-

You've Never Seen Such Thorough Service STOP IN SOON Phillips "66" Products EAST SIDE "66" Rocky Stewart 1303 E. 1st 364-2644

DANCE MOONLIGHTER Each FRIDAY & SATURDAY NIGHT ADULTS ONLY Ice and Setups Available No liquor for sale MUSIC-POOL-DANCE Arrangements made for private parties, for every occasion. For reservations call Days 364-0964 or 364-1760. Nites 364-9629 1-mile north of Hereford Hwy 385

FOR QUICK REPLACEMENT OF CRACKED SAFETY GLASS Call 364-2652 HEREFORD GLASS CO. INC. For All Your Glass Needs Insurance claims promptly serviced. We use nationally advertised SAFETY GLASS.

FOR THE BEST DEALS ON NEW or USED CARS Come in and talk with one of the Men at JOHN ORSBORN BUICK-PONTIAC-GMC at 142 N. MILES or 221 N. 25 Mi. Ave. 364-0990 364-1222

UNITED MOBILE HOMES 12' x 44' FINANCING AVAILABLE \$3885⁰⁰ E.V. CARTER ALMA CARTER 201 UNION

EXPERT REPAIR on BUICK PONTIAC GMC TRUCKS JOHN ORSBORN Free Pickup phone 364-0990 HOME OWNED

Look to SHOOK For Quality LEE Tires and on the Farm & Road Service As Close As Your Phone Quality With Price - MAY WE SERVE YOU 364-1010

NOW IN HEREFORD BONDED LICENSED BELL ELECTRIC ELECTRICAL CONTRACTOR New Construction and Repair - Residence and Commercial 364-6841 Larry Bell 803 S. Texas

FOR THE BEST DEALS ON NEW or USED CARS Come in and talk with one of the Men at JOHN ORSBORN BUICK-PONTIAC-GMC at 142 N. MILES or 221 N. 25 Mi. Ave. 364-0990 364-1222

I TURNED AROUND AND IT WAS SOLD! We don't intend to make whirling dervishes of our clients, but we DO put all of our experience and facilities to work right now when you delegate the selling job to us. \$25,000. to \$35,000. HOME LISTING NEEDED. NOW...CONTACT OR CALL... Ralph Owens & Associates, Inc. 311 Park Avenue REALTORS Phone 364-2222

Come children of the universe, let Donovan take you away, far far away. FRIDAY & SATURDAY ALL SEATS 75¢

The Pied Piper

JACK WILD, DONALD PLEASANCE, JOHN HURT and DONOVAN, "THE PIED PIPER" written by Andrew Birkin, Jacques Demy, Frank Pöschel. Directed by Jacques Demy. Music composed and sung by Ulfarsson. A Paramount Picture. SHOWTIMES 12:30 - 2:10 - 3:55 - 5:35

WRESTLING WAHA ZIBRE
 Sponsored by the Hereford Lions Club
SATURDAY JAN. 5 8:00 PM
8 MEN BATTLE ROYAL
 OVER THE TOPE ROPE LAST MATCH ON THE CARD
MAIN EVENT
BULL RAMOS vs. RICKY ROMERO
 Man Mountain MIKE vs. Don FARGO
 Nick KOZAK vs. Alex PEREZ
 Leo BURK vs. El Gran TAPIA

HEREFORD BULL BARN

THE BEST FROM HOLLYWOOD! COMMONWEALTH THEATRES MOVIE MARQUEE

SPECIAL ENGAGEMENT NOW SHOWING! **Marlon Brando Last Tango in Paris** (X) NO ONE UNDER 18 ADMITTED Limited Artists PERFORMANCE SCHEDULE: 7:30 & 9:50

Starts TONIGHT! Burt Reynolds is The Man Who Loved Cat Dancing. THE MAN WHO LOVED CAT DANCING ALL COLOR PROGRAM! PLUS

ROD STEIGER JAMES COBURN WILL BLOW YOU APART! A FISTFUL OF DYNAMITE GATES OPEN 6:30 SHOWTIME 7:00 TOWER DRIVE IN

Starts SUNDAY MEET BIG CLEO and her UNDERSIZED UNDERWORLD The Little Cigars Mob WARNING! THEY ARE HAZAROUS TO YOUR HEALTH AND

1000 CONVICTS and a Woman! GATES OPEN 6:30 SHOWTIME 7:00 TOWER DRIVE IN

SELL IT FAST! BUY IT RIGHT! USE WANT ADS!

Phone 364-2030

CLASSIFIED ADVERTISING RATES

Readers Ads (Minimum 10 words) 1st insertion per word 10c
Additional insertions, when paid in advance: per word 8c

Classified Display (8 pt. type under a specific heading, 1 column width only - no art or signature cuts) per col. inch \$2.00
Repeat insertion without copy change per col. inch \$1.50

Display Advertising Not Classified under a heading, but placed on the classified page per col. inch \$1.54

Deadline for Classified Advertising in the SUNDAY BRAND. 5 p.m. Friday

Deadline for Classified Advertising in the HEREFORD BRAND. 5 p.m. Tuesday

1. FOR SALE

Miscellaneous

TOWN & COUNTRY MOBILE HOME SALES
Hwy 60 & MYRTLE
Phone 364-0169
Also spaces & furnished trailers for rent at
TOWN & COUNTRY ESTATES
4B-1-23-9p

"THE SADDLE HOUSE"
COMPLETE Riding Equipment
New & Used Saddles
HIGGINS & SOUTH TEXAS ST.
PHONE 364-2581
1B-1-14-1c

"CARPET"
Financing Available
C&W CARPET
PLAINS AND N. 25 MILE AVE.
PHONE 364-3448
B-28-1c

"WE BUY AND SELL USED FURNITURE BARRICK FURNITURE WEST HWY. 60 PHONE 364-3552 1B-37-1c"

GARAGE EQUIPMENT NEW & USED
Air Compressors, Valve Machines, Steam Cleaners, etc.
BOYD MACHINE & SUPPLY
1306 East Park
Phone 364-1055
1B-1-9-1c

RCA WHIRLPOOL commercial ICE MAKERS - Sales and Service - Brown Sheet Metal.
B-1-11-52-1c

FOR SALE
1-21" Color Console TV
1-19" B&W Portable
WE MAKE HOUSE CALLS
Repairs on all makes & models, color, B&W and radios.
TOWER TV
248 Northwest Drive
Phone 364-4740
B-1-1-1c

New Singer Dealer in Hereford. Sewing machines and vacuum cleaner repair. All makes. Free estimate in advance. Work done by Singer trained mechanics. Scissors sharpened. Call 364-4051. Sanders Sewing Machine Center, 226 Main, Hereford.
B-1-4-1c

For Sale: 250 small beef type calves. Call Pete or Terry Caviness, 364-0900.
B-1-12-51-4c

STATED MEETING
SECOND MONDAY
7:30 P.M.
Thursday
DEGREE WORK
Charlie Brown W.M.
W.A. Phipps Sec.

Hereford
Rotary
Club
meets every
Monday at 12:05
Civic Club Center
(Jim Hill)

Lions Club
meets each
Wednesday, 12 Noon
Civic Club Center
(Jim Hill)

For Sale: English Pointer Pups. Good breeding, 8 weeks old. 40,000 miles. New steel belted tires. Sale or trade for older pickup. Call 364-3484.
B-1-16-27-2c

FULLER BRUSH PRODUCTS.
Good personal service. Mrs. Jessie Fuller, 258-7228.
S-1-27-1c

THE amazing Blue Lustre will leave your upholstery beautifully soft and clean. Rent electric shampooer \$1.
Hereford Hardware
B-1-19-27-2c

For sale: Zenith color TV, Early American-console, maple twin bed with mattress, box springs. 289-5810.
B-1-16-24-1c

For Sale: 1971 Honda. \$200.00. Call 276-5821 after 5:00 p.m.
B-1-10-49-1c

1972 Kawasaki Race, 250 cc. Good condition. Call 357-2344.
B-1-10-23-1c

For sale: Packard-Bell coffee table stereo. Call 364-0700; 364-2707 after 5:00 p.m.
B-1-12-25-1c

Model 12 Winchester, 3" mag. \$140.00. 788 Remington, 243-Cal. with 3 to 9 variable scope. \$85.00.
Call 289-5951
B-1-19-25-1c

LEFT IN LAY-AWAY
Electrographic Component Stereo with built-in tape player. AM-FM Multiflex Radio, Garrard Turntable, 200 watts, 10 speaker. Original price \$399.95. Assume balance of \$245.00 or \$10.00 monthly payments
at
MARTINS SOUND CENTER
Corner of Georgia & I-40 in Wolfen Square, Amarillo
B-1-31-1c

KIRBY VACUUMS
Rebuilt with genuine Kirby parts.
\$59.95 & up.
2 year guarantee
Your only authorized Kirby Distributor.
Kirby Sales & Service
522 Irving
Phone 364-0422
B-1-35-1c

WATER BEDS
Southwest Carpet, 209 Park Avenue. Phone 364-1763.
B-1-41-1c

See Our Line Of Bargains On new and used furniture and appliances
Open week days 9 to 12 p.m. to 6 p.m. Sat. 8 to 8
BIG JIM'S FURNITURE
Higgins & So. Texas St.
Phone 364-1873
B-1-19-1c

For Sale: 4 months old Brittany Spaniel Puppies. Registered AKC. Call 364-1717.
B-1-12-14-1c

For Sale: Used gas dryer. Excellent condition. Call 364-5746 after 6:00 p.m.
B-1-11-14-1c

For Sale: Go-Kart-McCullach Powered. Call 364-5780 after 4:00 p.m.
B-1-10-14-1c

GARAGE SALE Wednesday through Saturday. Large sizes men-women clothes, mir., bike, misc. One Block West of Big Daddy's. Mrs. J.F. Messer.
B-1-1-1p

BE gentle, be kind, to that expensive carpet, clean it with Blue Lustre. Rent electric shampooer \$1.
Duckwalls,
Sugarland Mall
B-1-21-1-2c

For Sale: Westinghouse built-in dish washer-harvest gold. \$75.00. Phone 364-2520.
B-1-11-48-1c

For Sale: White German Shepherd Puppies. Perfect Christmas gifts. Call Johnny Rickman 276-5822.
B-1-12-50-1c

FOR SALE:
1-Heiser Broncho Riding Saddle.
1-Big sorrel mare, gentle enough for anyone to ride who can pull back on the reins and say WHOA.
THE SADDLE HOUSE
Higgins & South Texas
Phone: 364-3583
B-1-27-1c

For Sale: Two registered male beagles. Phone 285-3337.
B-1-27-1p

To give away black and white collie pups.
809 Sunset
B-1-10-27-2c

NEW FURNITURE
1-Stereo Console with China Hutch, reg. \$499.95, now \$399.95.
1-Quadraphonic Component set, reg. \$525.95, now \$469.95.
New living room suits as low as \$179.95
New recliners as low as \$79.95.
PLAINS FINANCE CORPORATION
206 So. 25 Mile Avenue
Phone 364-3400
B-1-49-1c

For Sale: Oswalt Manure Spreader for tandem truck. Excellent condition. Call 806-
B-2-13-51-1c

3. FOR SALE

Automobiles

1971 Ford 1/2 ton. Power & air. 40,000 miles. New steel belted tires. Sale or trade for older pickup. Call 364-3484.
B-3-21-48-1c

MILBURN MOTOR COMPANY
We pay cash for Used Cars
136 Sampson
Phone 364-9077
B-3-33-1c

Going overseas - must sell 1973 Cutless Supreme maroon and white Olds. Bucket seats, automatic transmission, factory air, low mileage. Call 364-1110 or 364-1302.
B-3-23-51-1c

WALKER'S USED CARS AND TRUCKS
WE BUY, SELL OR TRADE
400 West First
Phone 364-2250
1B-41-1c

SELECTED USED TIRES \$3.00 UP
30 Day Guarantee
MONTGOMERY-WARD AUTOMOTIVE SALES
114 EAST PARK
1B-3-17-1c

NEW & USED CARS
ORVAL WATSON FORD
PHONE 364-2727
1B-3-18-1c

Used Chevy Pickup for sale. See at 515 Avenue K or call 364-0210.
B-3-13-27-2c

1971 Ford 1/2 ton Pickup. V8. Automatic, excellent condition. Phone 364-5324 after 7:00 p.m.
B-3-13-27-3c

For Sale: 1970 Maverick. Good gas mileage. Good condition. Call 289-5936 after 6:00 p.m.
B-3-27-2p

1967 Chevy 2, six cyl. Call or come by. 364-1170, 904 E. 3rd.
B-3-12-14-1c

4. REAL ESTATE

For Sale Or Trade

For Sale By Owner
Large double wide mobile home. 24x50. 3 bedrooms, 1 1/2 baths, large lot 85x119. 6 ft. fenced backyard with fruit trees, patio. 11x11 playhouse, wood burning fireplace, gas grill and light. Priced to sell.
Call 364-2423
B-4-50-1c

LAND
60 acres with a well. Good farmland, at \$325.00 per acre.
Carthel Real Estate
Phone 364-0944
B-4-43-1c

I have Farm and Ranch Buyers; I need your listings.
J.M. HAMBY REAL ESTATE
Phone 364-3566
Res. 364-2553
B-4-29-1c

REPOSESSION
\$14,950.00 - 3 bedroom, 1 1/2 baths, attached garage, carpeted, built-in range. Total move-in cost less than \$500.00.
437 AVENUE C
Move in cost less than \$500.00. New FHA Loan.
B-2-13-24-1c

5 UNIT APARTMENTS
Good location, good income.
LOANS
Let us help you with your financing FHA-VA & CONVENTIONAL LOANS are now available. Check with our office for details.
TWO BEDROOM
Carpeted with finished room and garage. Fenced yard. \$9,500.
THREE BEDROOM
Carpeted, double car garage. On Labor Camp Road. \$9,000.
Board of Realtors Multiple Listing Service
CARTHEL REAL ESTATE
206 N. 25 Mile Avenue
Phone 364-9944
364-0938
Wayne Carthel
Leola Peters
B-4-10-1c

2. FOR SALE
Farm Equipment
For sale: 40 ft. flat trailer, and 1957 Ford dump truck. Call 364-2530.
B-2-13-24-1c

See Us For Parts-Sweeps-Chisels for
Graham (Home) Plows DAVIS IMPLEMENT 409 EAST FIRST Phone 364-2811 B-2-35-1c

See Us For Mayrath Grain Augers Also have parts in stock
DAVIS IMPLEMENT 409 EAST FIRST Phone 364-2811 B-2-35-1c

NEW FURNITURE
1-Stereo Console with China Hutch, reg. \$499.95, now \$399.95.
1-Quadraphonic Component set, reg. \$525.95, now \$469.95.
New living room suits as low as \$179.95
New recliners as low as \$79.95.
PLAINS FINANCE CORPORATION
206 So. 25 Mile Avenue
Phone 364-3400
B-1-49-1c

For Sale: Oswalt Manure Spreader for tandem truck. Excellent condition. Call 806-
B-2-13-51-1c

For Sale: Oswalt Manure Spreader for tandem truck. Excellent condition. Call 806-
B-2-13-51-1c

For Sale: Oswalt Manure Spreader for tandem truck. Excellent condition. Call 806-
B-2-13-51-1c

For Sale: Oswalt Manure Spreader for tandem truck. Excellent condition. Call 806-
B-2-13-51-1c

CLOSED ON SUNDAYS

"Yes, we're open on Sundays - that's just the title of this week's show."

"Yes, we're open on Sundays - that's just the title of this week's show."

LET'S MAKE A DEAL
on this 3 bdrm. 2 baths, carpet, built-ins, utility room, double garage. This home is about 3 yrs. old and has an isolated master bedroom. Priced \$18,500.00 with \$1,000.00 down.
B-4-15-23-1c

CLOSE TO SCHOOL & SHOPPING CENTER
3 bdrm. 1 1/2 baths, single garage, all built-ins. Buy equity and assume payments of \$151.00 per month.
B-4-10-44-1c

ONE OF THE PRETTIEST ON MIMOSA STREET
3 bdrm. brick 2 1/2 baths, den and kitchen comb. dining room, living room, ref. air, 2 fireplaces, \$2,000.00 worth of drapes. Double garage with electric door lift. Built-in vacuum cleaner, patio with bar-beque grill, gas lines front and back. 5 1/4 per cent loan. Buy equity and assume payments of \$236.00 per mo.
B-4-19-1-1c

MOBILE HOME SPACE for rent. Call 276-5333.
B-5-10-3-1c

TRAILER SPACE FOR RENT
Northwest Mobile Lodge,
Phone 364-1108
B-5-10-13-1c

BEDROOMS BY THE WEEK
Plains Motel.
B-5-23-9p

Small two bedroom trailer house for rent. Phone 364-4533 or 220 North 25 Mile Avenue.
B-5-15-27-1c

For Rent: 3 room house, partially furnished. Call 364-4917 after 4:00 p.m.
B-5-27-2p

For Rent: Trailer space at 217A Avenue A. Paved street and drive. Phone 364-4553.
B-5-14-27-1c

APARTMENTS, FURNISHED
1 and 2 bedrooms with kitchen, dinette and bath. Also 2 bedrooms, living room, kitchen, dinette and bath.
FORREST AVENUE APARTMENTS
Phone 364-1887
B-5-4-1-1c

FURNISHED one and two bedroom apartments. Inquire 112 Avenue H, Apt. 36.
B-5-12-46-1c

Unfurnished one bedroom duplex. Bills paid, couple only, no pets. References needed. Phone 289-5757.
B-5-14-48-1c

SUMMERFIELD MOBILE MANOR
FIRST MONTH FREE. 7 miles West on Hwy. 60. Phone 357-2552.
B-5-15-10-1c

OFFICE FOR LEASE Ralph Owens 364-2222.
1B-5-10-14-1c

Office for rent. Answering service available. **AGRI-SCIENCE CENTER**, 1500 West Park. Phone 364-5822.
B-5-14-19-1c

Thunderbird Apartments. Unfurnished 2 bedroom, 1 1/2 bath. Phone 364-5360.
B-5-13-19-1c

For Lease: Old Lockwood Grader Building. Contact S.T. Wiseman 364-1752 or 258-7295 or Leroy Williamson, 364-1933.
B-5-14-51-1c

HAMBY REAL ESTATE OFFICE
Calvin Edwards - 364-3566
Gerald Hamby - 364-1534
Chick Weemes - 364-3169
J.M. Hamby - 364-2553
EQUAL HOUSING OPPORTUNITY
B-4-27-1c

For sale by owner: large 2 bedroom house, very large double garage. Well insulated, low gas consumption. Phone 364-1423 or 364-2553.
B-4-19-24-1c

DIAMOND VALLEY MOBILE HOME PARK
600 & 700 Block Avenue H, Sioux & Cherokee, 700 Block Avenue G.
Phone 364-1423 or 364-2553
B-5-50-1c

For sale by owner: large 2 bedroom house, very large double garage. Well insulated, low gas consumption. Phone 364-1423 or 364-2553.
B-4-19-24-1c

WHY PAY OUTRAGEOUS PRICE FOR YOUR APARTMENT?

We have apartments to suit your needs in any size. Your rent is adjusted to your income so you will not be paying more than you can afford. Apartments have stove, ref., garbage disposal, central heat and air and fenced playgrounds, laundry facilities, recreation room, tree cable vision.
1 bedroom start \$79.95
2 bedrooms start \$101.55
3 bedrooms start \$113.75
4 bedrooms start \$123.90
All bills paid. Deposit is required.
JLUE WATER GARDEN
612 Irving
Phone 364-4461
2B-5-2-1c

FOR LEASE OR SALE
Commercial building (8,000 sq. ft.) Prime location-corner Main and 2nd St. Hereford, Texas. Priced to sell (Financing available at 7 1/2 per cent). Call Collect for details:
Geo. Masso:
512-682-6191 or
512-682-8091.
B-5-1-10c

For rent; 3 bedroom house 2 miles out. Call 364-0669.
B-5-1-1p

For rent: 3-4 bedroom house one-half block from Alkman School. \$185.00 per month; one month in advance, \$150.00 deposit. Phone 364-0128.
B-5-22-1-2c

Need man experienced in farm work with small family. Good salary and housing. Call 296-3432.
B-8-15-51-4c

6. WANTED
CONTRACT GROWERS WANTED
Must have 10-50 acres irrigated land. Grow new high volume, high protein forage for feed and seed. \$3,000 to \$15,000 investment for earning potential of \$50,000 to \$100,000.
Write Box 3284
Arlington, Texas
Phone 817-274-3003
(Sunday-Friday)
B-6-50-8c

Want to buy: Sugarbeet equipment - planter, thinner, harvester, cultivator. Write Richard K. Lackmann, Rt. 1, Moorhead, Minn. 56560.
B-6-16-51-4c

Want to buy: Pasture for cattle. O.G. Hill 364-1871 or 364-4741; Foster Hill, 364-4217 or 364-4741.
B-6-14-17-1c

Need farm hand. Must be able to irrigate and handle tractors. Call George Ritter, 289-5826.
B-8-14-26-3c

NEED PAPER BOYS
APPLY AT
THE HEREFORD BRAND
B-8-44-1c

MISSOURI BEEF PACKERS, INC.
is now accepting applications for female production workers. No experience necessary, but must be willing to learn and work. This is year around employment, not seasonal. We offer:
+Paid vacation
+Paid holidays
+Company paid group hospital insurance
+Good wages
Apply at Personnel Office of Missouri Beef Packers, Inc. Friona, Texas. 4 miles West of Friona on Hwy 60.
We are an equal opportunity employer.
3B-8-14-1c

AVON
GOT A STACK OF CHRISTMAS BILLS? Start earning that extra cash as an Avon Representative! You can make money in your spare time by selling quality products on a flexible schedule. Call today for more details: 364-5169 or 364-0640.
B-8-27-2c

Seamstress wanted. Experience preferred, but not necessary. Phone 364-5951 or 364-4908.
B-8-11-27-2c

Millwright to finish feed mill and operate. Good salary, bonus. Phone 806-364-0491.
B-8-51-4c

Need experienced irrigation farm hand. Prefer man 22 to 40 years. House furnished. Call 276-5235 or 276-5251.
B-8-17-51-4c

FREIGHTLINER DRIVER.
\$250.00 per week. 10 years California long haul required.
B-8-51-4c

Wanted: Two ladies with car 2 hours, 5 days. \$60.00 per week. Call Norma Villarreal, Stanley Home Products, 364-6570.
B-8-19-14-1c

Full time electrician's helper. Experience preferred. Phone 364-6841.
B-8-10-1-2c

FEED MILL MANAGER WANTED
Must know mill operation and rations for cattle. Prefer bilingual. 25,000 head capacity Southeastern, New Mexico feedlot. Salary commensurate with experience and ability to assume responsibility.
Call 505-457-2503
B-8-51-4c

School bus drivers needed. See Eldon Owens at school bus shop.
B-8-10-17-1c

Baby sitting in my home. Will give TLC. 238 Hickory. 364-4266.
B-9-11-51-1c

For the customers, scales to w...
One n...
Daddy's T...
H...
North...
Anson...
Ph...
A...
IN...
For info...
referrals...
or progr...
the disea...
364-454...
1.00 p...
Monday...
A UNIT...
EN...
IN...
J...
Ind...
PET...
11. BU...
WRE...
HERE...
NIGHT...
AP...
We repa...
of app...
guarant...
MONT...
JIM MA...
back an...
large o...
We...
DONT...
IT. Fr...
refin...
806-267...
Tree T...
Call C...
211...
CONC...
We will...
you a...
Estima...
HOMI...
Guara...
and...
perfor...
time...
HOM...
Rebu...
Parts...
guar...
auth...

The Hereford Brand, Hereford, Texas, January 3, 1974
 Will do baby sitting in my home. Nice neighborhood. Drop-ins welcome. 364-2135. B-9-13-27-6c
 Baby sitting in my home. Phone Alice Gilleland, 364-4175. B-9-10-26-6c

WANTED: Baby sitting. Call 364-2149 B-9-10-23-9c
 State Licensed Child Care For Working Mothers Hereford Day Care Center 364-1293 B-9-46-6c

10. NOTICE

For the convenience of you, our customers, we now have truck scales to weigh your scrap iron - One mile North of Big Daddy's Truck Stop. HEREFORD IRON & METAL North Progressive Road by City Dump Anson A. & June Dearing Phone 364-3850 or 364-3777 B-10-34-6c
ALCOHOLISM INFORMATION
 For information on alcoholism, referrals for help, counseling, or programs on the subject of the disease of alcoholism, Call 364-4540 from 8:00 a.m. till 12, 1:00 p.m. until 5:00 p.m. Monday through Friday. A UNITED FUND AGENCY B-10-12-6c

ENROLLING NOW FOR LESSONS IN OIL PAINTING Beginning JANUARY 14th Small classes. Individual attention PETERSEN STUDIO Phone 364-3198 B-10-14-6c

11. BUSINESS SERVICE
 AAA WRECKER SERVICE HEREFORD WRECKING COMPANY Day Phone 364-5380 NIGHTS 364-4009 and 364-0575 T-11-29-6c
 APPLIANCE REPAIR We repair all makes and models of appliances. All work guaranteed. MONTGOMERY WARD & CO. 114 East Park Phone 364-5801 B-11-52-6c
 JIM MANNING PLUMBING is back and ready to do your job - large or small. Phone 364-0931 We specialize in repairs B-11-27-2c

DON'T TOSS IT - REGLOSS IT. Furniture repaired and refinished. Call Tom Tompkins, 806-267-5831 collect. B-11-27-100
 Tree Trimming and Topping. Call Cliff's Tree Service 364-2111. B-11-10-46-6c
 B.L. Jones CONCRETE CONTRACTOR We will do your finishing or give you a turnkey job. Free Estimates. 246 16th Street Phone 364-6617 B-11-21-6c

DICKKEY'S DOZER SERVICE Dirt Work - All Kinds Bull dozers - Scrapers Back Hoe - Dragline Motorgrader See or Call FLOYD DICKEY S.E. 4th & Belsher Dimmitt, Texas Business Phone 647-4553 Residence Phone 647-4565 B-11-29-6c

WILL PICK UP JUNK CARS. FREE. Call 364-3350 or 364-3777 B-11-28-6c

HOME APPLIANCE REPAIRS Guaranteed work on all makes and models. 10 years experience. Available for night-time emergencies. JOE'S HOME APPLIANCE REPAIRS 343 N. Main Ph. 364-5751 B-11-45-6c

KIRBY VACUUMS Rebuilt with genuine Kirby Parts. \$59.95 & up, two year guarantee. Your only authorized Kirby Distributor. Kirby Sales & Service 304 N. Irving Ph. 364-0422 B-11-35-6c

FRANK WESTER CEMENT CONTRACTOR 107 BRADLEY Residential-Commercial Turakey job Straight finish Phone 364-5169 B-11-29-6c

CUSTOM GRINDING New Moeller Tub Grinder. Burrs, baled hay, ear corn, grain, manure. Call Russ Henninger, 806-376-9702 B-11-23-9p

WANTED 100 to 150 watches a week to repair by latest approved methods. COWAN JEWELERS B-11-15-29-6c

DRAGLINE SERVICE TAILWATER PIT CLEANING DUMP TRUCKS 30 ton crane. BOBBY GRIEGO Day Phone 364-0574 Night - 364-2322 B-11-14-6c

KELLY ELECTRIC DOUG AND VIRGIL Electrical Contractors Residential Commercial All bids and wiring Call bids and wiring competitive. Phone 364-1345 Night phone 364-2012 or 364-1345 Box 130 B-11-46-6c

13. LOST & FOUND
 LOST: Drawers from an antique chest. Reward. Call collect - Plainview 293-3963. B-13-11-27-2c
 STRAYED: Two steers or heifers from Northwest of Hereford. Branded "D7" on right leg, yellow tag in right ear. Call 364-6399 or 276-5857. B-13-23-27-3c

LOST: German Shepherd Dog. Tan head and chain collar. Answers to "Tramp". Reward. Call 364-1779. B-13-15-27-3c

CARD OF THANKS The family of Ervin Robinson, Sr., wishes to express their gratitude and appreciation to the many who called, brought food, sent flowers and made donations to the Heart Fund and the Cancer Fund. Our special thanks to the Police Night dispatcher, the patrolman who responded so rapidly and the men on the emergency unit. The Family of Ervin Robinson, Sr.

Reservations Needed In Some Parks
 Need to reserve a cabin, lodge room; shelter or group facility in a state park for, say, Memorial Day next year? Better get your name in to the park superintendent between Jan. 1 and 10 because the Parks and Wildlife Department is holding a drawing at 10 a.m. Jan. 11 in the respective parks to set reservations for high-use days during the coming year. Parks and Wildlife Department officials say that only cabins, lodge rooms, shelters and group facilities may be reserved. Campsites and trailer spaces in state parks may not be reserved but are continually available on a first-come, first-served basis. Those wishing to participate in the Jan. 11 drawing must submit their reservation requests to the park superintendent where the facility is desired. Reservation requests will not be accepted by the department until Jan. 1. Additional dates should be indicated in the order of preference to insure a greater chance for obtaining a reservation. Requests for cabins must include the total number of persons in the immediate

family who will occupy the cabin. Children under six years of age need not be included. In the event one cabin will not accommodate the number of persons in the immediate family, two cabins will be reserved with the participant's permission, provided an adult occupies the cabin with the minor children. A deposit - check or money order - in an amount equal to one day's fee must accompany reservation requests. Participants in the drawing will be notified after Jan. 11 if their reservations have been confirmed. If not, the deposit will be returned. After Jan. 11, reservations for cabins, lodge rooms, shelters and group facilities will be made on the usual first-come, first-served basis.

Ellis TAMALES
 GIVES YOUR BUDGET A BREAK!

UNITED MOBILE HOMES
 12' x 44' FINANCING AVAILABLE \$3885.00 E.V. CARTER ALMA SALES 201 UNION

Retirement Incomes Rise In Deaf Smith County

The number of Deaf Smith County residents who are getting Social Security checks each month from Washington continues to rise. And the amounts that are going to them are increasing as well. The latest upward revision, just acted upon by Congress, will boost their payments by 11 per cent during 1974. A total of 1,915 persons in the local area, more than ever before, are now on the receiving end. Three years ago there were 1,663. THEY ARE benefitting from the contributions they made to the Social Security Trust Fund over the years via money deducted from their pay envelopes. The majority of the recipients are retired workers. The others include disabled workers, widows, children and other dependents. The facts and figures are contained in the latest annual report of the Social Security Administration.

THEY SHOW that the increase in the number of beneficiaries has been due, chiefly, to periodic revisions of the law. The changes have had the effect of bringing more and more people under coverage. Nationally, as a result, more than 9 out of 10 working and people now have Social Security protection. Along with the increase in the number of persons enrolled has been the big increase in the size of pension checks. IN DEAF Smith County, the average annual payment per recipient was \$1,403 in the past year, considerably more than

the \$851 paid three years ago. The combination of more beneficiaries and bigger checks has boosted considerably the inflow of cash to the local area. The government's figures show that overall payments to local residents, as of the beginning of this year, were at the annual rate of \$2,688,000. Three years before, by way of contrast, the total was only \$1,416,000. THE RISE, 89.8 per cent, tops the United States rise of 81.3 per cent and the West South Central States' 80.9 per cent. To help pay for the 11 per cent hike in benefits that will be going

into effect, the amount of a worker's income that will become subject to Social Security tax will be \$13,200 in 1974, instead of the present \$10,800.

After Husband-What is left of a sweetheart after the nerve has been killed. -Quonset Scout.
 Do They? Achievements are like trousers - they become threadbare if you rest on them. -Sunshine Magazine.
 Safest The safest rule for predictions is to be indefinite about the date. Sooner or later almost anything can happen. -Labor.

EXPERT REPAIR ON BUICK PONTIAC GMC TRUCKS JOHN ORSBORN
 Free Pickup phone 364-0990 HOME OWNED

Look to SHOOK
 For Quality LEE Tires and on the Farm & Road Service As Close As Your Phone Quality With Price - MAY WE SERVE YOU Shook Tire Co. 364-1010

You've Never Seen Such Thorough Service STOP IN SOON Phillips "66" Products EAST SIDE "66" Rocky Stewart 1303 E. 1st 364-2644

DANCE MOONLIGHTER
 Each FRIDAY & SATURDAY NIGHT ADULTS ONLY
 Ice and Setups Available No liquor for sale MUSIC-POOL-DANCE Arrangements made for private parties, for every occasion. For reservations call Days 364-0064 or 364-1760. Nites 364-9629 1-mile north of Hereford Hwy 385

FOR QUICK REPLACEMENT OF CRACKED SAFETY GLASS
 Call 364-2652 HEREFORD GLASS CO. INC. For All Your Glass Needs Insurance claims promptly serviced. We use nationally advertised SAFETY GLASS

I TURNED AROUND AND IT WAS SOLD!
 We don't intend to make whirling dervishes of our clients, but we DO put all of our experience and facilities to work right now when you delegate the selling job to us. \$25,000. to \$35,000. HOME LISTING NEEDED NOW...CONTACT or CALL... Ralph Owens & Associates, Inc. 311 Park Avenue REALTORS Phone 364-2222

BELL ELECTRIC
 NOW IN HEREFORD BONDED LICENSED
 BELL ELECTRIC ELECTRICAL CONTRACTOR New Construction and Repair - Residence and Commercial 364-6841 Larry Bell 803 S. Texas

FOR THE BEST DEALS ON NEW or USED CARS
 Come in and talk with one of the Men at JOHN ORSBORN BUICK-PONTIAC-GMC at 142 N. MILES or 221 N. 25 Mi. Ave. 364-0990 364-1222

COME CHILDREN OF THE UNIVERSE, let Donovan take you away, far far away
 FRIDAY & SATURDAY ALL SEATS 75¢
 JACK WILD DONALD PLEASANCE JOHN HURT DONOVAN "THE PIED PIPER" SHOWTIMES 12:30 2:10 3:55 5:35

THE PIED PIPER
 JACK WILD DONALD PLEASANCE JOHN HURT DONOVAN "THE PIED PIPER" SHOWTIMES 12:30 2:10 3:55 5:35

WRESTLING WCHA LIBRE
 Sponsored by the Hereford Lions Club
SATURDAY JAN. 5 8:00 PM
8 MEN BATTLE ROYAL
 OVER THE TOPE ROPE LAST MATCH ON THE CARD
 MAIN EVENT
BULL RAMOS vs. RICKY ROMERO
 Man Mountain MIKE vs. Don FARGO
 Nick KOZAK vs. Alex PEREZ
 Leo BURK vs. El Gran TAPIA

HEREFORD BULL BARN
 THE BEST FROM HOLLYWOOD! COMMONWEALTH THEATRES MOVIE MARQUEE

SPECIAL ENGAGEMENT
 NOW SHOWING!
Marlon Brando
Last Tango in Paris
 (X) NO ONE UNDER 18 ADMITTED United Artists
 PERFORMANCE SCHEDULE: 7:30 & 9:50
 STAR 364-2037

Starts TONIGHT!
 Burt Reynolds is The Man Who Loved Cat Dancing.
THE MAN WHO LOVED CAT DANCING
 ALL COLOR PROGRAM!
 ROD STEIGER
 JAMES COBURN WILL BLOW YOU APART!
A FISTFUL OF DYNAMITE

GATES OPEN 6:30 SHOWTIME 7:00
TOWER DRIVE-IN

Starts SUNDAY!
MEET BIG CLEO and her UNDERSIZED UNDERWORLD
The Little Cigars Mob
 WARNING! THEY ARE HAZARDOUS TO YOUR HEALTH
 AND Caged brutes in a killer frenzy
LOUD CONVICTS and a Woman!
 GATES OPEN 6:30 TOWER DRIVE-IN

Delicatessen



SAVE MORE '74

START THE NEW YEAR SAVING AT FURR'S

WE RESERVE THE RIGHT TO LIMIT QUANTITIES

WE REDEEM USDA FOOD STAMPS

PRICES IN THIS AD EFFECTIVE THRU JANUARY 5, 1974

BANANAS
ORANGES
APPLES
NUTS

LETTUCE
CALIFORNIA ICEBURG, LB. **20¢**

CARROTS
1 LB. CELLO PKG. EACH **15¢**

GRAPEFRUIT
TEXAS RUBY RED LB. **14¢**

GOLDEN RIPE LB. **11¢**

FANCY CALIFORNIA NAVEL, 8 LB. BAG **\$1.09**

RED OR GOLDEN DELICIOUS OR RED ROME, YOUR CHOICE, LB. **28¢**

ALL VARIETY LB. **69¢**

HALIBUT STEAK SQUARES **\$1.29** LB.

BEEF PATTIES FROZEN **89¢** LB.

DELUXE RIBS FOR BAR-B-Q FURR'S PROTEIN, LB. **69¢**

BACON **99¢** LB.
Farm Pac 1 Lb. Frontier 1 Lb. Farm Pac Sliced Slab

ROUND SIRLOIN RIB STEAK CLUB STEAK T-BONE CUBE STEAK RUMP ROAST SWISS STEAK

FURR'S PROTEIN STEAK, LB. **\$1.19**

FURR'S PROTEIN STEAK, LB. **\$1.19**

FURR'S PROTEIN, LB. **\$1.19**

FURR'S PROTEIN, LB. **\$1.39**

FURR'S PROTEIN STEAK, LB. **\$1.49**

FURR'S PROTEIN STEAK, LB. **\$1.49**

FURR'S PROTEIN, LB. **\$1.13**

ROUND BONE ARM FURR'S PROTEIN, LB. **\$1.13**

SPAGHETTI FRANCO AMERICAN 15-OZ. CAN **5 FOR \$1.00**

HANDI-WRAP 200 FT. ROLL **49¢**

CORN FOOD CLUB, CREAM STYLE OR WHOLE KERNEL GOLDEN, NO. 303 CAN **4 FOR 88¢**

GREEN BEANS FOOD CLUB WHOLE NO. 303 CAN **4 FOR \$1.00**

PRUNE JUICE FOOD CLUB QUART JAR **49¢**

PEANUT BUTTER FOOD CLUB CREAMY OR CRUNCHY 18-OZ. **59¢**

PEAS FOOD CLUB SWEET NO. 303 CAN **4 FOR \$1.00**

GELATIN FOOD CLUB, ASS'T. FLAVORS 3-OZ. PKG. **10¢**

COCA COLA OR 7up 32-OZ. **6 FOR \$1.25**

CHUNK STYLE TUNA FOOD CLUB LIGHT, NO. 1/2 CAN **49¢**

Frozen Food Favorites

CUT CORN WHOLE KERNEL GAYLORD FRESH FROZEN, 24-OZ. **49¢**

CUT BROCCOLI TOP FROST-FRESH FROZEN, 20-OZ. PKG. **58¢**

POTATOES GAYLORD FRENCH FRIED, 5-LB. **99¢**

TOPPING FOOD CLUB 8-OZ. PACKAGE **39¢**

INSTANT POTATOES FOOD CLUB 13-OZ. **39¢**

ART LINKLETTER'S MONEY-SAVING SUGGESTION!

TOPAZ STONWARE

THIS WEEK **DINNER PLATE**

Regular Price 79¢

49¢ each

START NOW - COLLECT A FULL SET

Safe in oven and dishwasher and so smart!

FOOD CLUB ASSORTED CAKE MIX BOX **3 FOR 99¢**

THIS COUPON ENTITLES YOU TO

SAVE 50¢ FOLGER'S COFFEE

3-LB. CAN, With Coupon **\$2.75** Without Coupon **\$3.25**

Expires 1-5-74

LIMIT ONE COUPON PER FAMILY

THIS COUPON ENTITLES YOU TO

SAVE 25¢ IVORY LIQUID

32-OZ. With Coupon **64¢** Without Coupon **89¢**

Expires 1-5-74

LIMIT ONE COUPON PER FAMILY

THIS COUPON ENTITLES YOU TO

SAVE 40¢ INSTANT COFFEE

FOLGER'S 10-OZ. JAR With Coupon **\$1.29** Without Coupon **\$1.69**

Expires 1-5-74

LIMIT ONE COUPON PER FAMILY

<p>CHILI BOWL OLD FASHION STYLE EXCELLENT THERMAL QUALITIES OVEN PROOF, DISH WASHER SAFE EA. 49¢</p>	<p>COFFEE MUG IRONSTONE BROWND RIP KEEPS COFFEE WARM LONGER EA. 49¢</p>	<p>STORAGE CONTAINER ANCHOR HOCKING OLD FASHION 1/2 GAL. SIZE GLASS LID NO. 348E \$1.79</p>	<p>BABY SHAMPOO TOPCO 16-OZ. 49¢</p>	<p>PEPTO-BISMOL 8-OZ. SIZE 94¢</p>	<p>DENTU-CREAM TOOTH PASTE WERNET'S ECO. 79¢</p> <p>ASPIRIN BAYER'S CHILDREN 36-COUNT 29¢</p>
<p>SANITARY TAMPONS KOTEX, BOX OF 40 COUNT REG. OR SUPER 99¢</p>	<p>STORAGE BOX BIG 24 1/2" x 14 3/8" x 10 5/8" SIZE REINFORCED HANDLES, EA. 99¢</p>	<p>CORNBREAD SKILLET LODGE HEAVY CASTIRON WEDGE SHAPE MAKES CRUSTY BREAD-EVERYTIME EACH \$1.99</p>	<p>VAPORUB VICK'S 3.1-OZ. JAR 89¢</p>	<p>Balm Barr PURE ORGANIC VITAMIN SKIN CARE OIL 1/2-OZ. SIZE \$2.10</p>	<p>SHOP Furr's MIRACLE PRICES</p>

Supplement to THE HEREFORD BRAND, Thursday, January 3, 1974, Hereford, Texas

Supplement to THE HEREFORD BRAND, Thursday, January 3, 1974, Hereford, Texas

Sale. 25% off our entire line of knit fabrics. Sew and save.

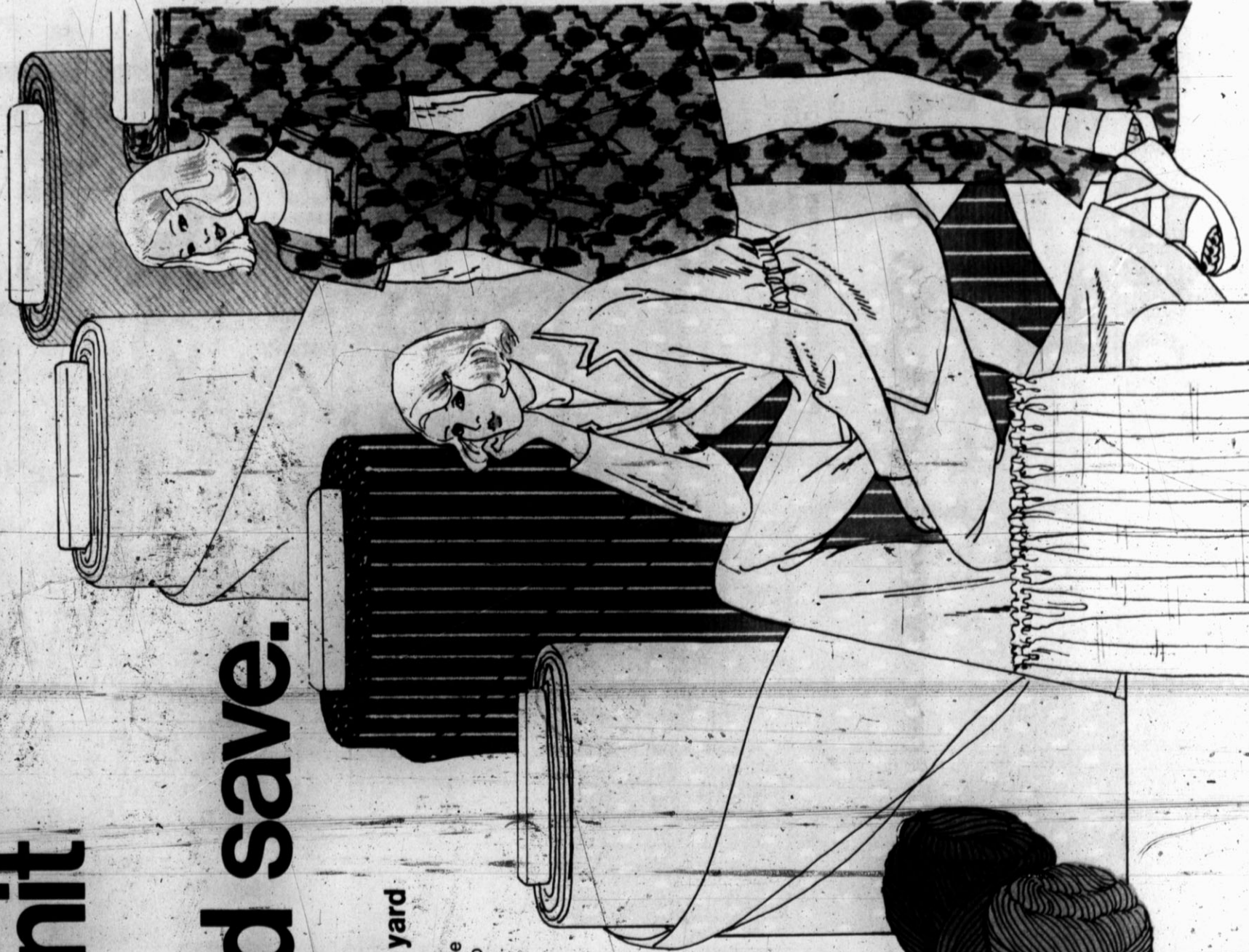

Save \$1 yard

Reg. 3.99. Sale 2.99 yd. Polyester doubleknits in your choice of crepe stitch solids and smart plaids. Also a wide range of fancy coordinates. Machine wash, tumble dry. 58/60" wide.

Sale prices effective thru Saturday. Charge it.

Special 77¢

4 oz. skein of Cresslan® acrylic yarn in a wide variety of fashion colors.



Special 99¢

Polyester marquisette tailored panels with 3" bottom hems. Available in 40x63" or 40x81" sizes. White.

JCPenney

We know what you're looking for.

HWY 385N. OPEN DAILY 8:00 A.M. to 8:00 P.M.

Our wildest white sale ever. Save on these beautiful JCPenney sheets.

Grab your charge and charge or use our convenient lay-away.

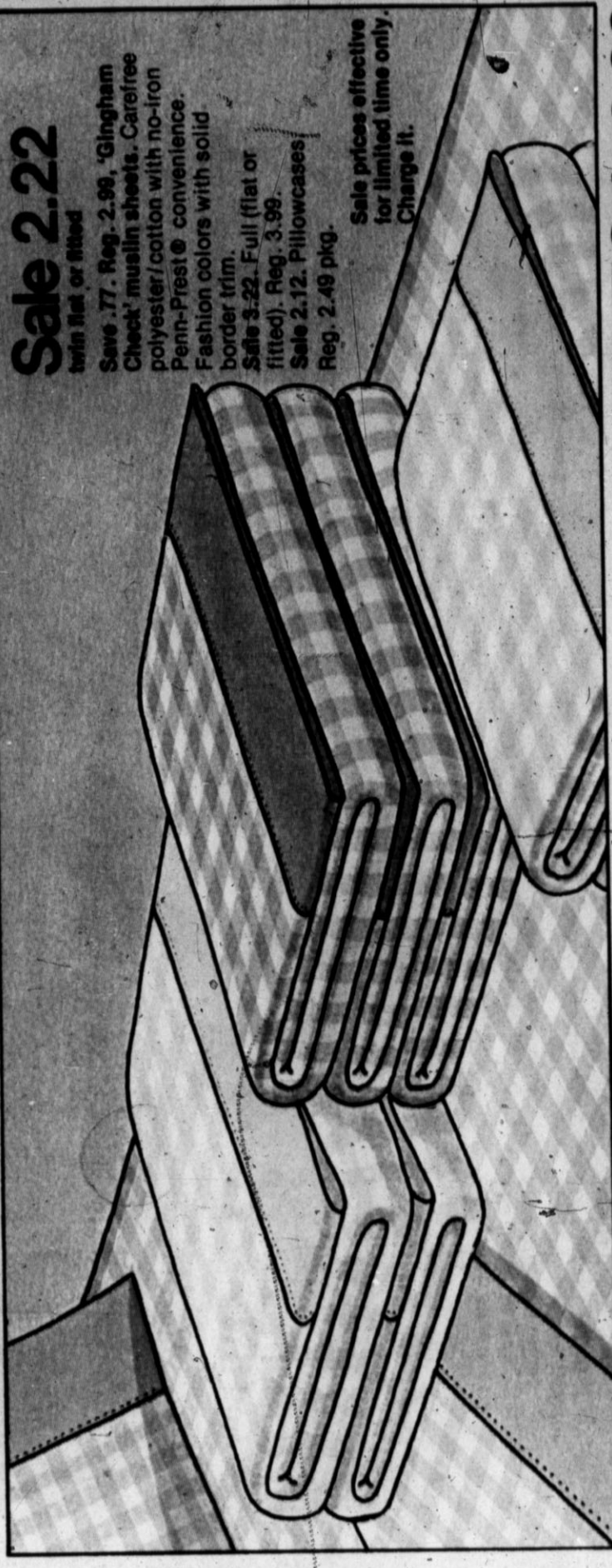

Sale 2.22

twin flat or fitted
Save .77. Reg. 2.99. "Gingham Check" muslin sheets. Carefree polyester/cotton with no-iron Penn-Prest® convenience. Fashion colors with solid border trim.
Sale 3.22. Full (flat or fitted). Reg. 3.99.
Sale 2.12. Pillowcases. Reg. 2.49 pkg.

Sale prices effective for limited time only. Charge it.

Sale 2.22

twin flat or fitted

Save .77. Reg. 2.99. Long solid muslins. Long wearing blend of polyester/cotton. Beautiful choice of decorator colors.
Sale 3.22. Full (flat or fitted). Reg. 3.99.
Sale 2.12. Pillowcases. Reg. 2.49 pkg.

Sale 2.22

twin flat or fitted

Save 1.27. Reg. 3.49. "Parisienne" muslin print sheets. Delicate bouquet of flowers on a white ground. Polyester/cotton.
Sale 3.22. Full (flat or fitted). Reg. 4.49.
Sale 2.12. Pillowcases. Reg. 2.99 pkg.

JCPenney

We know what you're looking for.

Starts THURSDAY

JANUARY 3

HEREFORD, TEXAS
435 Sugarland Mall
9:30 am til 6:00 pm
Saturday 9:30 am til 8:00 pm

THE HEREFORD BRAND

Save on our famous white muslin sheets. Curtain sale.

Sale 166 twin flat or fitted

Reg. 2.19, Penn-Prest® white muslin sheets in a long wearing blend of polyester/cotton. Never need ironing. Just say "charge it" and fill your linen closet now, or put them in convenient lay-away.
Sale 2.26. Full flat or fitted.
 reg. 2.79
Sale 2 for 1.26. Pillowcases.
 Reg. 2 for 1.39.



2 for 388

Polyester filled, full finished bed pillows at a super price. 20x26 with cord edges. Printed top, solid bottom.

Sale prices effective for a limited time only. For additional values on bedding items, see our JCPenney's Catalog. Charge it.

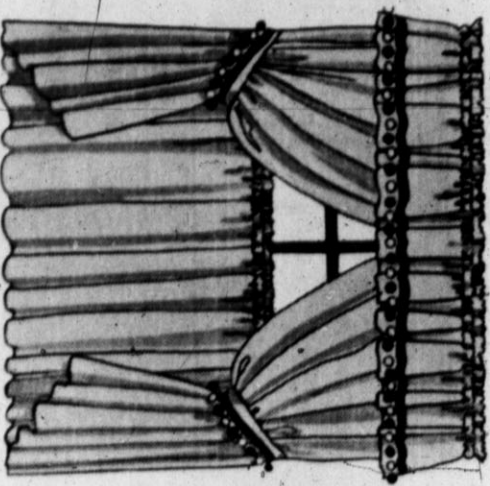

Sale 239

Reg. 2.99, "Pamela" is Penni-Prest® rayon sharkskin with colorful ball fringe. 68x36". Valance, reg. 2.59. **Sale 2.07**

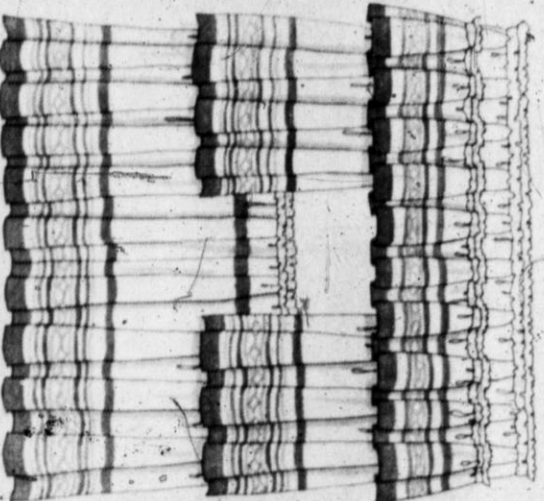

Sale 343

Reg. 4.29, "Mayan" Osnaburg cotton weave with color coordinated trim. 68x36". Valance, reg. 2.79. **Sale 2.23**

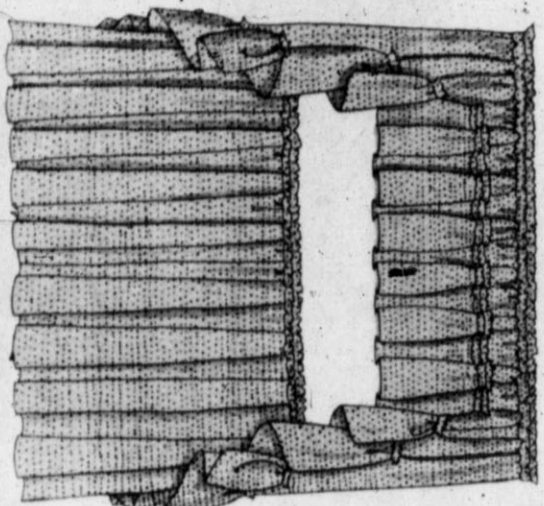

Sale 295

Reg. 3.69, "Mercury 11" Dacron® polyester nylon. Flocked white dots on colors. 80x36". Swag toppler, reg. 4.69. **Sale 3.75**

JCPenney

We know what you're looking for.

20% off these elegant 'Jewel-Tex'® drapes.

Sale 1160
50x84"
Reg. 14.50

Sale 2000
75x84"
Reg. 25

Sale 2640
100x84"
Reg. 33

Floor length drapes in the three most popular widths, 'Jewel-Tex' are a luxurious blend of dobby weave cotton/rayon. Penn-Prest so they machine wash, tumble dry, never need ironing. Thermal acrylic back insulates year 'round. Wide selection of decorator colors.
 Sale prices effective thru Saturday. Charge it. For something special, shop the JCPenney Catalog, available in most stores.

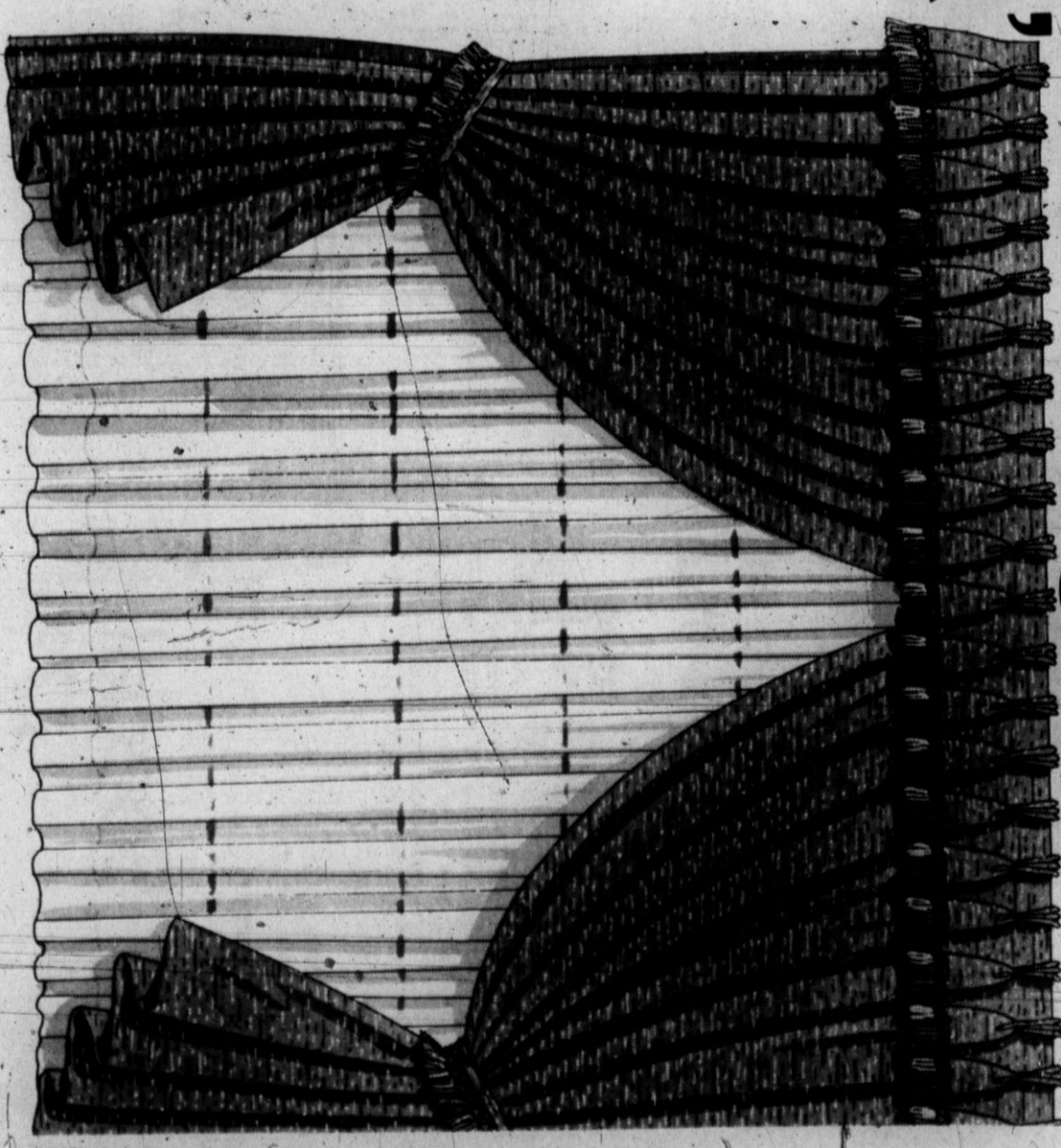

And 20% off bedspreads and rugs.

Sale 1680

Reg. \$21, "Vallejo" full size bedspread in woven cotton jacquard patterns. Choose from rich colors.

Sale 1600

Reg. \$20, "Royalty" full size spread. Crushed velvet look in flocced rayon/cotton. Vivid colors.

Sale 319
24x36"

Reg. 3.99, Nylon cut and loop pile with geometric border. Style 3521. Or Polyester plush pile in multi-colored stripes. Style 3571. 27x48". Reg. 5.99. **Sale 4.79**

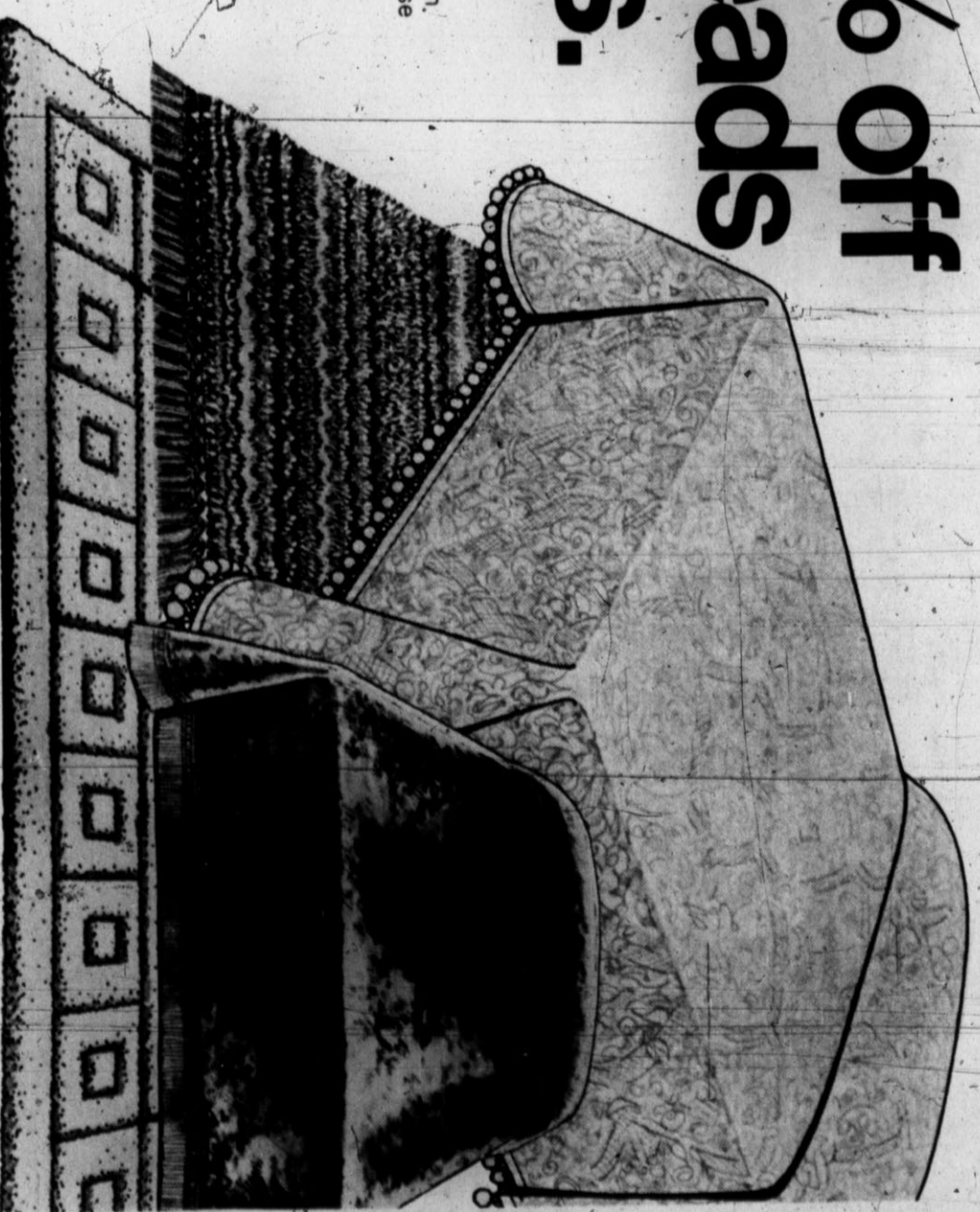

JCPenney

We know what you're looking for.



BOANISHCOBADA



EXCEL



SAN KOTEX REG.

Sale 20% off on our entire line of bras and girdles. Shape up and save.

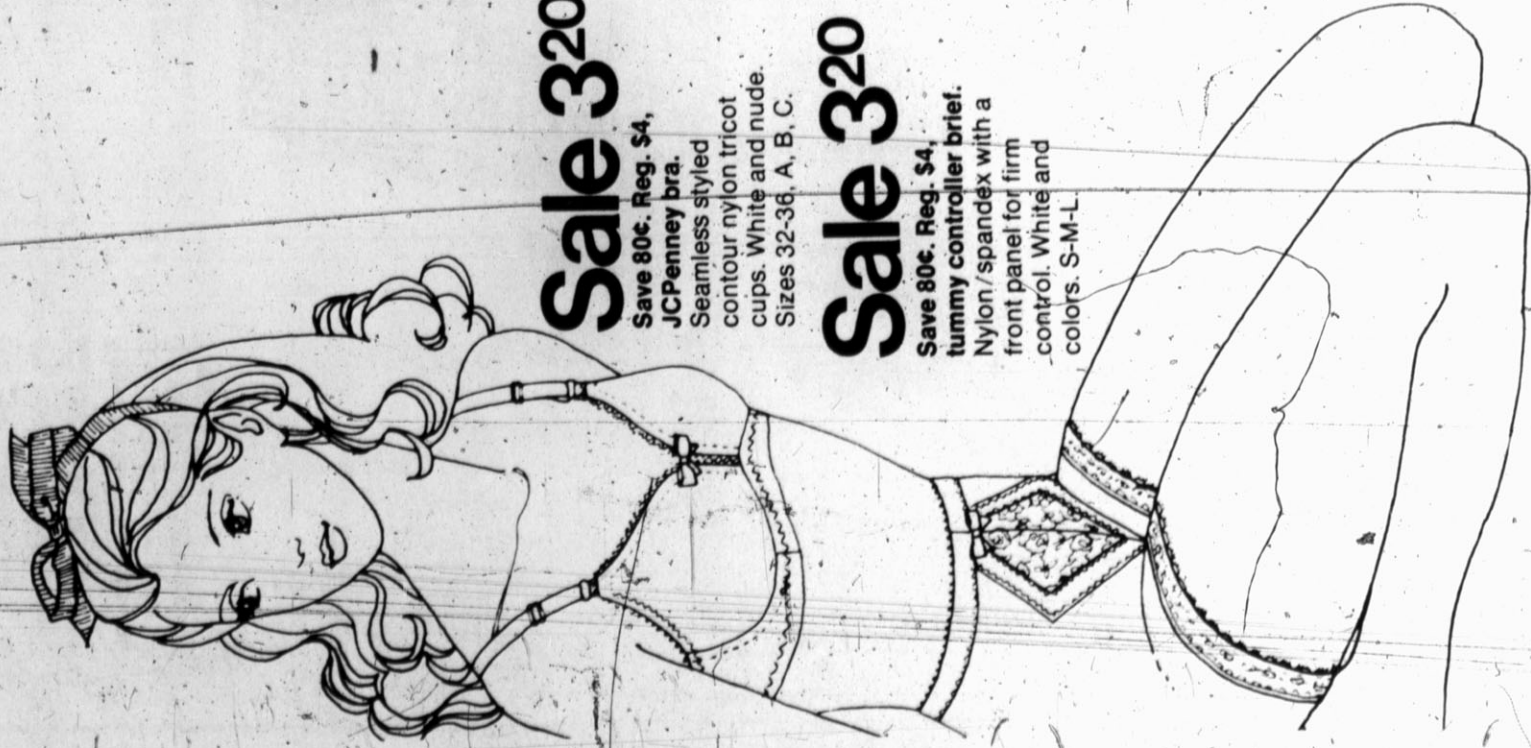

Sale 320
Seamless styled
contour nylon tricot
cups. White and nude.
Sizes 32-38, A, B, C.
JCPenney bra.

Sale 320
Save 80¢. Reg. \$4.
Nylon/spandex with a
tummy controller brief.
front panel for firm
control. White and
colors. S-M-L



Sale \$4
Save \$1. Reg. \$5
Comfort Hours bra.
Nylon lace cups. 32-40, C.
Sale 4.80.
D cups reg. \$6.



Sale 280
Save 70¢. Reg. 3.50.
Cross-over nylon tricot
bra. Natural cup
comfort and fit. 32-40,
B, C. White.



Sale 320
Save 80¢. Reg. \$4.
Garterless brief.
Nylon/spandex with
lace underlay front
panel. Shaped seat.



Sale \$4
Save \$1. Reg. \$5.
Nylon/spandex with
criss cross bands for
tummy control. S-M-L

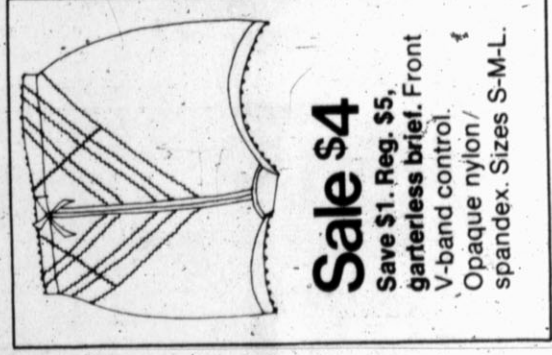

Sale \$4
Save \$1. Reg. \$5.
Garterless brief. Front
V-band control.
Opaque nylon/
spandex. Sizes S-M-L.



Sale 720
Save 1.80. Reg. \$9.
Long leg panty girdle.
Nylon/acetate/spandex
with criss cross inner
bands.



Special 2 for 88¢
All sheer sandalfoot
pantihose. Super-fit, super
stretch proportioned sizes.
Suntan, coffee bean or gail.

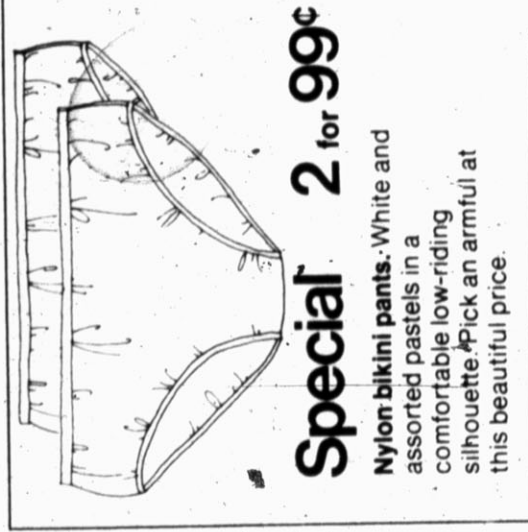

Special 2 for 99¢
Nylon bikini pants. White and
assorted pastels in a
comfortable low-riding
silhouette. Pick an armful at
this beautiful price.

Sale prices effective thru
Saturday only.
Charge it.

JCPenney

We know what you're looking for.

At the Sign of the WHITEFACE BULL

HWY 385N. OPEN DAILY 8:00 A.M. to 8:00 P.M.

Rest assured. Our sales and specials for your bed are great.

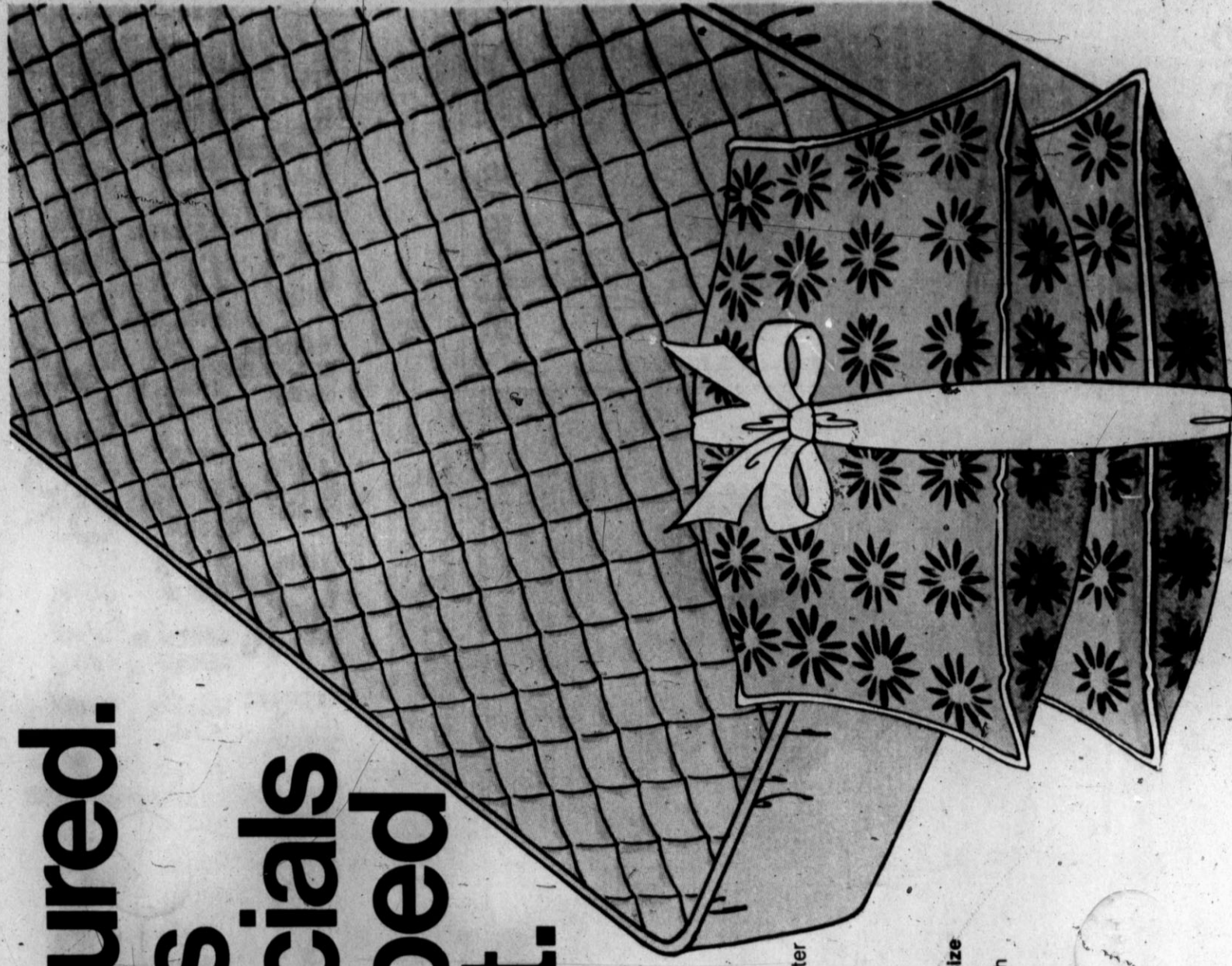

Sale 399
twin fitted

Save \$1. Reg. 4.99, quilted mattress pads.
Cotton cover with bonded polyester fill.
Protects your bed. Retains its whiteness after
many washings.
Full size, reg. 6.19. Sale 4.95.

Sale 2 for \$8 standard size
Save \$2. Reg. 2 for \$10, Dacron® fiberfill 11
pillows. Completely washable polyester with
Penn-Prest® polyester/cotton ticking.
-Sale 2 for 9.60. Queen size, reg. 2 for \$12.
-Sale 2 for 12.80. King size, reg. 2 for \$16.

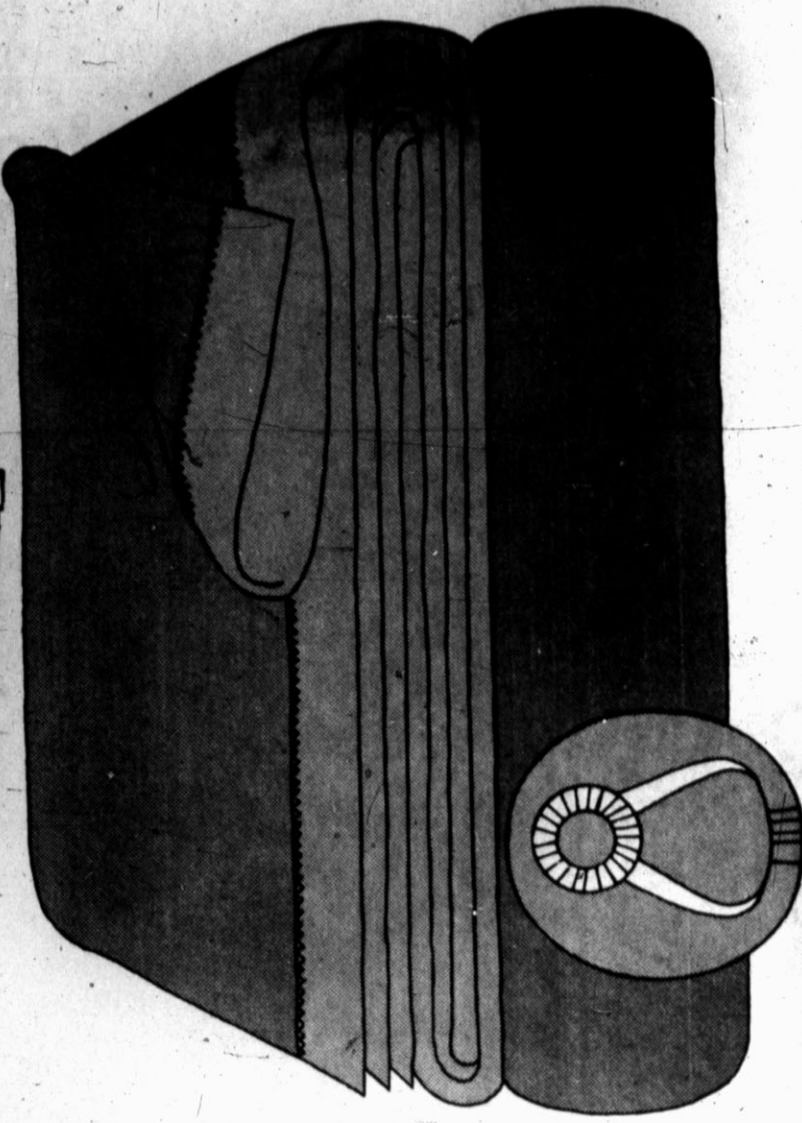

Special \$13. full size
Beautiful electric blanket in a quality blend of
polyester/acrylic with single control heating
comfort. Choose from goldenrod, avocado,
blue or pink.

Sale prices effective thru
Saturday only.
For all your bedding needs
see our JCPenneys Catalog.
Charge it.

JCPenney

We know what you're looking for.

SELL IT FAST! BUY IT RIGHT! USE WANTADS!

Phone 364-2030

CLASSIFIED ADVERTISING RATES
 Readers Ads (Minimum 10 words) 1st insertion per word 10c
 Additional insertions, when paid in advance: per word 8c
 Classified Display (8 pt. type under a specific heading, 1 column width only — no art or signature cuts) per col. inch \$2.00
 Repeat insertion without copy change per col. inch \$1.50
 Display Advertising Not Classified under a heading, but placed on the classified page per col. inch \$1.54
 Deadline for Classified Advertising in the SUNDAY BRAND. 5 p.m. Friday
 Deadline for Classified Advertising in the HEREFORD BRAND. 5 p.m. Tuesday

1. FOR SALE Miscellaneous

TOWN & COUNTRY MOBILE HOME SALES
 Hwy 60 & MYRTLE
 Phone 364-0169
 Also spaces & furnished trailers for rent at TOWN & COUNTRY ESTATES
 1B-1-23-9p

"THE SADDLE HOUSE"
 COMPLETE Riding Equipment
 New & Used Saddles
 HIGGINS & SOUTH TEXAS ST.
 PHONE 364-3582
 1B-1-5-14c

"CARPET!"
 Financing Available
 CAW CARPET
 PLAINS AND N. 35 MILE AVE.
 PHONE 364-3488
 B-30-14c

WE BUY AND SELL USED FURNITURE
 BARRICK FURNITURE
 WEST HWY 60
 PHONE 364-3552
 1B-37-4c

GARAGE EQUIPMENT
 NEW & USED
 Air Compressors,
 Valve Machines, Steam Cleaners, etc.
 BOYD MACHINE & SUPPLY
 1306 East Park
 Phone 364-1055
 1B-1-9-14c

RCA WHIRLPOOL commercial ICE MAKERS — Sales and Service — Brown Sheet Metal.
 B-1-11-52-14c

FOR SALE
 "19" Color Console TV
 "19" B&W Portable
 WE MAKE HOUSE CALLS.
 Repairs on all makes & models, color, B&W and radios.
 TOWER TV
 248 Northwest Drive
 Phone 364-4740
 B-1-35-14c

New Singer Dealer in Hereford. Sewing machines and vacuum cleaner repair. All makes. Free estimate in advance. Work done by Singer trained mechanics. Scissors sharpened. Call 364-4051. Sanders Sewing Machine Center, 226 Main, Hereford.
 B-1-4-14c

For Sale: 250 small beef type calves. Call Pete or Terry Caviness, 364-4907.
 B-1-12-51-4c

STATED MEETING
SECOND MONDAY
 7:30 P.M.
 Thursday
DEGREE WORK
 Charitie Brown W.M.
 W.A. Phipps Sec.
 Hereford Rotary Club
 meets every Monday at 12:05
 Civic Club Center (Jim Hill)
 Lions Club meets each Wednesday, 12 Noon
 Civic Club Center (Jim Hill)

FOR SALE: AKC Registered Wire Fox Terrier Puppies. Six Weeks Old. Call 364-0199.

FOR SALE
 Registered Apaloosa horses. Bred Apaloosa fillies, Apaloosa Stallion — 10 years old and gentle to ride and a good cow horse (Grandson of Whistle Breches)
 J.A. Crofford
 Phone 364-0952
 B-1-20-14c

Oak firewood for sale: 209 Kibbe. Call 364-6919.
 B-1-10-26-2p

LEFT IN LAY-AWAY
 Electrographic Component Stereo with built-in tape player. AM-FM Multiflex Radio, Garrard Turntable, 200 watts, 10 speaker. Original price \$399.95. Assume balance of \$245.00 or \$10.00 monthly payments
 at
MARTINS SOUND CENTER
 Corner of Georgia & 1-40 in Wolfen Square, Amarillo
 B-1-31-14c

KIRBY VACUUMS
 Rebuilt with genuine Kirby parts.
 \$69.95 & up.
 2 year guarantee
 Your only authorized Kirby Distributor.
 Kirby Sales & Service
 522 Irving
 Phone 364-0422
 B-1-35-14c

WATER BEDS
 Southwest Carpet, 209 Park Avenue. Phone 364-1763.
 B-1-41-14c

See Our Line Of Bargains On new and used furniture and appliances
 Open week days 9 to 12 (p.m. to 6 p.m., Sat. 8 to 8)
BIG JIM'S FURNITURE
 Higgins & So. Texas St.
 Phone 364-1873.
 B-1-19-14c

Fireplace wood for sale. Call 364-2111.
 B-1-10-46-14c

For Sale: Westinghouse built-in dish washer-harvest gold. \$75.00. Phone 364-2520.
 B-1-11-48-14c

For Sale: White German Shepherd Puppies. Perfect Christmas gifts. Call Johnny Rickman 276-5822.
 B-1-12-50-14c

FOR SALE:
 1-Heiser Broncho Riding Saddle.
 1-Big sorrel mare, gentle enough for anyone to ride who can pull back on the reins and say WHOA.
THE SADDLE HOUSE
 Higgins & South Texas
 Phone 364-3583
 B-1-27-14c

For Sale: Two registered male beagles. Phone 266-3337.
 B-1-27-1p

To give away black and white cdlie pups.
 309 Sunset
 B-1-10-27-2c

NEW FURNITURE
 Stereo Console with Chroma Hutch, reg. \$499.95, now \$399.95.
 1-Quadraphonic Component set, reg. \$525.95, now \$469.95.
 New living room suits as low as \$179.95.
 New recliners as low as \$79.95.
PLAINS
FINANCE CORPORATION
 906 So. 25 Mile Avenue
 Phone 364-3400
 B-1-49-14c

For Sale: English Pointer Pups. Good breeding, 8 weeks old. Females \$35.00, Males \$50.00. Call 364-6800.
 B-1-16-27-2c

FULLER BRUSH PRODUCTS.
 Good personal service. Mrs. Jessie Fuller, 258-7228.
 S-1-27-14c

THE amazing Blue Lustre will leave your upholstery beautifully soft and clean. Rent electric shampooer \$1.
 Hereford Hardware
 B-1-19-27-2c

For sale: Zenith color TV, Early American console, maple twin bed with mattress, box springs. 289-5810.
 B-1-16-24-14c

For Sale: 1971 Honda. \$200.00. Call 276-5821 after 5:00 p.m.
 B-1-10-49-14c

1972 Kawasaki Racer, 250 cc. Good condition. Call 357-2344.
 B-1-10-23-14c

For sale: Packard-Bell coffee table stereo. Call 364-0700; 364-2707 after 5:00 p.m.
 B-1-12-25-14c

Model 12 Winchester, 3" mag. \$140.00. 788 Remington, 243 Cal. with 3 to 9 variable scope. \$85.00.
 Call 289-5951
 B-1-19-25-14c

1/2 price sale — jeweled Christmas kits, tree skirts, stockings, ornaments, card holders, toys. Needlepoint tapestries.
 Dan's of Canyon
 B-1-18-51-6c

HAYGRAZER. Heavy grain, 4000 bales. Johnson grass, 3500 bales. \$50.00 per ton. 364-0484
 B-1-51-4c

CAK'PETS a fright? Make them a beautiful sight with Blue Lustre. Rent electric shampooer \$1.
 McCaslin Lumber
 B-1-19-13-2c

Oak fire wood for sale. Phone 364-5264 after 5:00 p.m.
 B-1-10-1-11c

For Sale: 4 months old Brittany Spaniel Puppies. Registered AKC. Call 364-1717.
 B-1-12-1-14c

For Sale: Used gas dryer. Excellent condition. Call 364-5746 after 6:00 p.m.
 B-1-11-1-14c

For Sale: Go-Kart-McCullach Powered. Call 364-5780 after 4:00 p.m.
 B-1-10-1-4c

GARAGE SALE. Wednesday through Saturday. Large sizes men-women clothes, mirci-bike, misc. One Block West of Big Daddy's. Mrs. J.F. Messer.
 B-1-1-1p

BE gentle, be kind, to that expensive carpet, clean it with Blue Lustre. Rent electric shampooer \$1.
 Duckwalls,
 Sugarland Mall
 B-1-21-1-2c

2. FOR SALE Farm Equipment
 For sale: 40 ft flat-trailer, and 1957 Ford dump truck. Call 364-2530.
 B-2-13-24-14c

See Us For Part-4-Sweeps-Chisels for Graham (Hoeme) Plows
DAVIS IMPLEMENT
 409 EAST FIRST
 Phone 364-2811
 B-2-35-14c

See Us For Mayrath Grain Augers
 Also have parts in stock
DAVIS IMPLEMENT
 409 EAST FIRST
 Phone 364-2811
 B-2-35-14c

Diesel tanks - 2000 to 18,000 gallons. Pressure tanks - 100 to 6000 gallons. 364-0484.
 B-2-51-4c

For Sale: Oswalt Manure Spreader. Excellent condition. Call 806-249-2242 or nites, 806-249-2247.
 B-2-13-51-14c

3. FOR SALE Automobiles

1971 Ford 1/2 ton. Power & air. 40,000 miles. New steel belted tires. Sale or trade for older pickup. Call 364-3484.
 B-3-21-48-14c

MILBURN MOTOR COMPANY
 We pay cash for Used Cars
 136 Sampson
 Phone 364-0077
 B-3-33-14c

Going overseas — must sell 1973 Cutless Supreme maroon and white Olds. Bucket seats, automatic transmission, factory air, low mileage. Call 364-1110 or 364-1302.
 B-3-23-51-14c

WALKER'S USED CARS AND TRUCKS
 WE BUY, SELL OR TRADE
 400 West First
 Phone 364-2250
 1B-41-14c

SELECTED USED TIRES \$3.00 UP
 30 Day Guarantee
MONTGOMERY-WARD AUTOMOTIVE SALES
 114 EAST PARK
 1B-3-17-14c

NEW & USED CARS
ORVAL WATSON FORD
 PHONE 364-2127
 1B-3-18-14c

Used Chevy Pickup for sale. See at 515 Avenue K or call 364-0210.
 B-3-13-27-2c

1971 Ford 1/2 ton Pickup. V8, Automatic, excellent condition. Phone 364-5324 after 7:00 p.m.
 B-3-13-27-2c

For Sale: 1970 Maverick. Good gas mileage. Good condition. Call 289-5936 after 6:00 p.m.
 B-3-27-2p

1967 Chevy 2, six cyl. Call or come by, 364-1170, 904 E. 3rd.
 B-3-12-1-14c

4. REAL ESTATE For Sale Or Trade
 For Sale By Owner
 Large double wide mobile home. 24x50. 3 bedrooms, 1 1/2 baths, large lot 65x119. 6 ft. fenced backyard with fruit trees, patio, 11x11 playhouse, wood-burning fireplace, gas grill and light. Priced to sell.
 Call 364-2423
 B-4-50-14c

LAND
 60 acres with a well. Good farmland, at \$325.00 per acre.
 Carthel Real Estate
 Phone 364-0944
 B-4-43-14c

I have Farm and Ranch Buyers. I need your listings.
J.M. HAMBY REAL ESTATE
 Phone 364-3566
 Res. 364-2553
 B-4-29-14c

REPOSESSION
 \$14,950.00 — 3 bedroom, 1 1/2 baths, attached garage, carpeted, built-in range. Total move-in cost less than \$500.00.
 437 AVENUE C
 Move in cost less than \$500.00. New FHA Loan.

5 UNIT APARTMENTS.
 Good location, good income.
LOANS
 Let us help you with your financing FHA-VA & CONVENTIONAL LOANS are now available. Check with our office for details.
TWO BEDROOM
 Carpeted with finished room and garage. Fenced yard. \$9,500.
THREE BEDROOM
 Carpeted, double car garage. On Labor Camp Road. \$9,900.
Board of Realtors Multiple Listing Service
CARTHEL REAL ESTATE
 206 N. 25 Mile Avenue
 Phone 364-0944
 364-0938
 Leola Peters
EQUAL OPPORTUNITY
 B-4-10-14c

CLOSED ON SUNDAYS

"Yes, we're open on Sundays — that's just the title of this week's show."

LET'S MAKE A DEAL
 on this 3 bdrm. 2 baths, carpet, built-ins, utility room, double garage. This home is about 3 yrs. old and has an isolated master bedroom. Priced \$18,500.00 with \$1,000.00 down.
 B-4-15-23-14c

Brick duplex. Good location. Cash or new loan. Phone 364-0022.
 B-4-10-44-14c

CLOSE TO SCHOOL & SHOPPING CENTER
 3 bdrm. 1 1/2 baths, single garage, all built-ins. Buy equity and assume payments of \$151.00 per month.
 B-4-19-1-14c

ONE OF THE PRETTIEST ON MIMOSA STREET
 3bdrm. brick 2 1/2 baths, den and kitchen comb. dining room, living room, ref. air, 2 fireplaces, \$2,000.00 worth of drapes. Double garage with electric door lift. Built-in vacuum cleaner, patio with bar-b-qe grill, gas lites front and back. 5 1/2 per cent loan. Buy equity and assume payments of \$236.00 per mo.
 B-4-19-1-14c

5. FOR RENT
MOBILE HOME SPACE for rent. Call 276-5333.
 B-5-10-3-14c

TRAILER SPACE FOR RENT
 Northwest Mobile Lodge,
 Phone 364-1108
 B-5-10-13-14c

BEDROOMS BY THE WEEK
 Plains Motel.
 B-5-23-9p

CLOSE TO TOWN & HOSPITAL
 2bdrm. with 1 bath, living room dining room, fully carpeted, single garage, fenced yard. Priced \$11,300.00 with \$1,300.00 down and payments you can afford.
 B-5-15-27-14c

IMMEDIATE POSSESSION
 Northwest 3 bdrm. brick, den and kitchen comb. Formal living room, 2 full baths, double garage, fully carpeted including baths and kitchen. Price \$23,500.00. Assume existing loan, approx. \$16,600.00 and pay \$176.02 per month. Owner will sell for \$3,000.00 down and carry 2nd or will trade for smaller home or clear mobile home.
 B-5-15-27-14c

SMALL EQUITY
 2 bdrm., 1 bath, new carpet, fenced yard. Just right for a couple who are wanting to get a start in life. Buy equity and assume payments at \$96.00 per month.
 B-5-14-48-14c

WANT A GOOD INVESTMENT?
 This duplex on 3rd Street is furnished and is in good shape inside and out. Priced at \$15,000.00 and you can buy this one for \$2,000.00 down and \$125.00 per month. It is rented for \$160.00. How can you lose?
 B-5-14-48-14c

1.7 ACRES OVER-LOOKING GOLF COURSE
 Ideal for nice Mobile home spaces or for a nice apartment house. 2 bdrm. rent house goes with land. Priced for \$16,000.00. Terms available.
 B-5-15-10-14c

1600 ACRES. DEAF SMITH COUNTY
 Approx. 550 acres cult., 7 small irr. wells, ideal cattle operation. Price \$157.50 per acre. Terms available.
 B-5-14-19-14c

We have some small tracts and some farms for sale. If you don't find the home or farm you need, we may have it or can find it for you.
 B-5-13-19-14c

HAMBY REAL ESTATE OFFICE
 Calvin Edwards — 364-1017
 Gerald Hamby — 364-1534
 Chick Weemes — 364-3169
 364-2558
 B-5-14-51-14c

EQUAL HOUSING OPPORTUNITY
 B-4-27-14c

For sale, by owner: large 2 bedroom house. Very large double garage. Well insulated, low gas consumption. Priced \$54,250.
 B-4-19-24-14c

WHY PAY OUTRAGEOUS PRICE FOR YOUR APARTMENT?

We have apartments to suit your needs in any size. Your rent is adjusted to your income, so you will not be paying more than you can afford. Apartments have stove, refrigerator, garbage disposal, central heat and air and fenced playgrounds, laundry facilities, recreation room, fire cable vision.
 1 bedroom start \$79.95
 2 bedrooms start \$113.75
 4 bedrooms start \$132.00
 All bills paid. Deposit is required.
JLUE WATER GARDEN
 412 Irving
 Phone 364-4441
 3B-5-2-14c

FOR LEASE OR SALE
 Commercial building (8,000 sq. ft.) Prime location-corner Main and 2nd St. Hereford, Texas. Priced to sell (Financing available at 7 1/2 per cent). Call Collect for details:
 Geo. Masso
 512-682-6191 or
 512-682-8091.
 B-5-1-10c

For rent: 3 bedroom house 2 miles out. Call 364-0669.
 B-5-1-1p

For rent: 3-4 bedroom house one-half block from Aikman School. \$185.00 per month; one month in advance, \$150.00 deposit, Phone 364-0128.
 B-5-22-1-2c

6. WANTED

CONTRACT GROWERS WANTED
 Must have 10-50 acres irrigated land. Grow new high volume, high protein forage for feed and seed. \$3,000 to \$15,000 investment for earning potential of \$50,000 to \$100,000.
 Write Box 3284
 Arlington, Texas
 Phone 817-274-3003
 (Sunday-Friday)
 B-6-16-51-4c

Want to buy: Sugarbeet equipment — planter, thinner, harvester, cultivator. Write Richard K. Lackmann, Rt. 1, Moorhead, Minn. 56560.
 B-6-16-51-4c

Want to buy: Pasture for cattle. O.G. Hill 364-1871 or 364-4741; Foster Hill, 364-4217 or 364-4741.
 B-6-14-17-14c

Want to lease - 1/2 to 1 Section of land. Will discuss rental. Call Lewis Block, 364-4117.
 B-6-15-7-14c

WANTED — CUSTOM FARMING. Contact Don Howard at Howards Custom Farming, 258-7761 or 364-0165.
 B-6-13-6-14c

Want to buy: Exerciser bicycle with handle bar motion. Phone 364-2575.
 B-6-1-2p

8. HELP WANTED

BEAUTIFUL OPPORTUNITY FOR ENERGETIC YOUNG LADY
 Own your own figure salon and be a part of a fast growing chain. Small investment required.
 Contact:
 Ethylene Marsh
 708 East Lake
 Brownfield, Texas 79316
 B-8-27-2c

AVON GOT A STACK OF CHRISTMAS BILLS? Start earning that extra cash as an Avon Representative! You can make money in your spare time by selling quality products on a flexible schedule. Call today for more details: 364-5169 or 364-0640.
 B-8-27-2c

Seamstress wanted. Experience preferred, but not necessary. Phone 364-5951 or 364-4908.
 B-8-11-27-2c

Millwright to finish seed mill and operate. Good salary, bonus. Phone 806-364-0491.
 B-8-51-4c

Need experienced irrigator/farm hand. Prefer man 22 to 40 years. House furnished. Call 276-5235 or 276-5251.
 B-8-17-51-4c

FREIGHTLINER DRIVER. \$250.00 per week. 10 years California long haul required.
 B-8-51-4c

DIAMOND VALLEY MOBILE HOME PARK
 600 & 700 Block Avenue H, Sioux & Cherokee, 700 Block Avenue G.
 Phone 364-1483 or 364-3588
 B-5-50-14c

MISSOURI BEEF PACKERS INC. is now accepting applications for beef loggers, production workers, maintenance men and kill floor personnel.
 We offer:
 +Year around employment
 +Paid vacations
 +Paid holidays
 +Company paid group Hospital insurance
 +Good wages
 +No experience necessary
 Apply at Personnel Office of Missouri Beef Packers Inc., Friona, Texas, 4 miles West of Friona on Hwy. 60.
 We are an equal opportunity employer.
 B-8-39-14c

Hide room labor wanted. We offer:
 +Good pay
 +Paid vacation
 +Paid hospitalization
 Colorado By-Products
 3 1/2 miles West Hwy 60
 Phone 276-5331 days;
 364-2495 nites
 B-8-42-14c

Need man experienced in farm work with small family. Good salary and housing. Call 256-3432.
 B-8-15-51-4c

WANTED - FARM MANAGER
 2500 acres irrigated, mostly alfalfa. Bilingual. Agricultural degree or equivalent. Excellent opportunity for person willing to assume complete responsibility. 506-67-2603.
 B-8-51-4c

We have openings for pellet mill and batch mixer operators. Experience preferred, but not required. Apply in person or call Hi-Pro Feed, Friona, Texas 806-247-2791.
 B-8-25-25-5c

Couples work together building a business. Start part time and grow. We train. Phone for interview: 364-2229 after 6:00 and weekends.
 B-8-21-26-14c

NEED PAPER BOYS APPLY AT THE HEREFORD BRAND
 B-8-44-14c

MISSOURI BEEF PACKERS, INC. is now accepting applications for female production workers. No experience necessary, but must be willing to learn and work. This is year around employment, not seasonal. We offer:
 +Paid vacation
 +Paid holidays
 +Company paid group hospital insurance
 +Good wages
 Apply at Personnel Office of Missouri Beef Packers, Inc. Friona, Texas, 4 miles West of Friona on Hwy 60.
 We are an equal opportunity employer.
 3B-8-14-14c

RN or LVN charge nurse needed for 11:00 to 7:00 shift. Apply in person Kings Manor-Westgate.
 B-8-16-30-14c

Wanted: Two ladies with car 2 hours, 5 days. \$60.00 per week. Call Norma Villarreal, Stanley Home Products, 364-6570.
 B-8-19-1-4c

Full time electrician's helper. Experience preferred. Phone 364-6841.
 B-8-10-1-2c

FEED MILL MANAGER WANTED
 Must know mill operation and rations for cattle. Prefer bilingual. 25,000 head capacity Southeastern, New Mexico feedlot. Salary commensurate with experience and ability to assume responsibility.
 Call 505-457-2503
 B-8-51-4c

School bus drivers needed. See Eldon Owens at school bus shop.
 B-8-10-17-14c

9. SITUATIONS

The Hereford Brand, Hereford, Texas, January 3, 1974

Will do baby sitting in my home. Nice neighborhood. Drop-ins welcome. 364-2135.

B-9-13-27-6c

Baby sitting in my home. Phone Alice Gilleland, 364-4175.

B-9-10-26-tfc

WANTED: Baby sitting. Call 364-2149

B-9-10-23-9c

State Licensed Child Care For Working Mothers Hereford Day Care Center 364-1293

B-9-46-tfc

10. NOTICE

For the convenience of you, our customers, we now have truck scales to weigh your scrap iron... One mile North of Big Daddy's Truck Stop. HEREFORD IRON & METAL

ALCOHOLISM INFORMATION

For information on alcoholism, referrals for help, counselling, or programs on the subject of the disease of alcoholism, Call 364-4540 from 8:00 a.m. 'till 12, 1:00 p.m. until 5:00 p.m. Monday through Friday.

ENROLLING NOW FOR LESSONS IN OIL PAINTING

Beginning JANUARY 14th Small classes, Individual attention PETERSEN STUDIO Phone 364-3198

11. BUSINESS SERVICE

AAA WRECKER SERVICE HEREFORD WRECKING COMPANY Day Phone 364-0590 NIGHTS 364-0099 and 364-0075

APPLIANCE REPAIR

We repair all makes and models of appliances. All work guaranteed. MONTGOMERY WARD & CO. 114 East Park Phone 364-5801

JIM MANNING PLUMBING

is back and ready to do your job - large or small. Phone 364-0931 We specialize in repairs

DON'T TOSS IT - REGLOSS IT

Furniture repaired and refinished. Call Tom Tompkins, 806-267-5831 collect.

B.L. Jones CONCRETE CONTRACTOR

We will do your finishing or give you a turnkey job. Free Estimates. 246 16th Street Phone 364-6617

DICKEY'S DOZER SERVICE

Dirt Work - All Kinds Bull dozers - Scrapers uck Hoe - Dragline Motorgrader

WILL PICK UP JUNK CARS. FREE.

Call 364-3350 or 364-3777

HOME APPLIANCE REPAIRS

Guaranteed work on all makes and models. 10 years experience. Available for night-time emergencies. JOE'S HOME APPLIANCE REPAIRS 343 N. Main Ph. 364-5751

KIRBY VACUUMS

Rebuilt with genuine Kirby Parts. \$59.95 & up, two year guarantee. Your only authorized Kirby Distributor. Kirby Sales & Service 522 Irving Ph. 364-0422

FRANK WESTER CEMENT CONTRACTOR 167 BRADLEY Residential-Commercial Turnkey job Straight finish Phone 364-5169

CUSTOM GRINDING New Moeller Tub Grinder. Burrs, baled hay, ear corn, grain, manure. Call Russ Heminger, 806-376-9702

WANTED 100 to 150 watches a week to repair by latest approved methods. COWAN JEWELERS B-11-15-29-tfc

DRAGLINE SERVICE TAILWATER PIT CLEANING DUMP TRUCKS \$30 ton crane. BOBBY GRIEGO Day Phone 364-6574 Night - 364-2322

KELLY ELECTRIC DOUG AND VIRGIL Electrical Contractors Residential Commercial All bids and wiring Call bids and wiring competitive. Phone 364-1345

13. LOST & FOUND LOST: Drawers from an antique chest. Reward. Call collect - Plainview 293-3963.

STRAYED: Two steers or heifers from Northwest of Hereford. Branded "D7" on right leg, yellow tag in right ear. Call 364-6399 or 276-5857.

LOST: German Shepherd Dog. Tan head and chain collar. Answers to "Tramp". Reward. Call 364-1779.

CARD OF THANKS The family of Ervin Robinson, Sr., wishes to express their gratitude and appreciation to the many who called, brought food, sent flowers and made donations to the Heart Fund and the Cancer Fund.

Reservations Needed In Some Parks Need to reserve a cabin, lodge room, shelter or group facility in a state park for, say, Memorial Day next year?

Ellie's TAMALES GIVES YOUR BUDGET A BREAK! UNITED MOBILE HOMES 12' x 44' FINANCING AVAILABLE \$3885.00

Bad Company It's no wonder the underworld is so rotten when you observe the kind of important citizens it pals with.

Highway Missile He who travels over 60 miles an hour is not driving his car - he's aiming it.

Retirement Incomes Rise In Deaf Smith County

The number of Deaf Smith County residents who are getting Social Security checks each month from Washington continues to rise. And the amounts that are going to them are increasing as well.

THEY ARE benefitting from the contributions they made to the Social Security Trust Fund over the years via money deducted from their pay envelopes.

THEY SHOW that the increase in the number of beneficiaries has been due, chiefly, to periodic revisions of the law.

IN DEAF Smith County, the average annual payment per recipient was \$1,403 in the past year, considerably more than

After Husband-What is left of a sweetheart after the nerve has been killed. -Quonset Scout.

Do They? Achievements are like trousers - they become threadbare if you rest on them. -Sunshine Magazine.

Safest The safest rule for predictions is to be indefinite about the date. Sooner or later almost anything can happen. -Labor.

EXPERT REPAIR on BUICK PONTIAC GMC TRUCKS JOHN ORSBORN Free Pickup phone 364-0990 HOME OWNED

Look to SHOOK For Quality LEE Tires and on the Farm & Road Service As Close As Your Phone Quality With Price - MAY WE SERVE YOU 364-1010

NOW IN HEREFORD BONDED LICENSED BELL ELECTRIC ELECTRICAL CONTRACTOR New Construction and Repair - Residence and Commercial 364-6841 Larry Bell 803 S. Texas

You've Never Seen Such Thorough Service STOP IN SOON Phillips "66" Products EAST SIDE "66" Rocky Stewart 1303 E. 1st 364-2644

DANCE MOONLIGHTER Each FRIDAY & SATURDAY NIGHT ADULTS ONLY Ice and Setups Available No liquor for sale MUSIC-POOL-DANCE Arrangements made for private parties, for every occasion. For reservations call Days 364-0664 or 364-1760. Nites 364-9629

FOR QUICK REPLACEMENT OF CRACKED SAFETY GLASS Call 364-2652 HEREFORD GLASS CO. INC. For All Your Glass Needs Insurance claims promptly serviced. We use nationally advertised SAFETY GLASS

I TURNED AROUND AND IT WAS SOLD! We don't intend to make whirling dervishes of our clients, but we DO put all of our experience and facilities to work right now when you delegate the selling job to us. \$25,000. to \$35,000. HOME LISTING NEEDED NOW...CONTACT or CALL... Ralph Owens & Associates, Inc. 311 Park Avenue REALTORS Phone 364-2222

Come children of the universe, let Donovan take you away, far far away. FRIDAY & SATURDAY ALL SEATS 75'

JACK WILD, DONALD PLEASANCE JOHN HURT DONOVAN, THE PIED PIPER Showtimes 12:30 - 2:10 - 3:55 - 5:35

WRESTLING WWA LIBRE SATURDAY JAN. 5 8:00 PM 8 MEN BATTLE ROYAL OVER THE TOPE ROPE LAST MATCH ON THE CARD MAIN EVENT BULL RAMOS vs. RICKY ROMERO

Man Mountain MIKE vs. Don FARGO Nick KOZAK vs. Alex PEREZ Leo BURK vs. El Gran TAPIA

HEREFORD BULL BARN

THE BEST FROM HOLLYWOOD! COMMONWEALTH THEATRES MOVIE MARQUEE

SPECIAL ENGAGEMENT NOW SHOWING! Marlon Brando Last Tango in Paris NO ONE UNDER 18 ADMITTED United Artists PERFORMANCE SCHEDULE: 7:30 & 9:50 STAR 364-2037

Starts TONIGHT! Burt Reynolds is The Man Who Loved Cat Dancing. THE MAN WHO LOVED CAT DANCING ALL COLOR PROGRAM! PLUS ROD STEIGER JAMES COBURN WILL BLOW YOU APART! A FISTFUL OF DYNAMITE GATES OPEN 6:30 SHOWTIME 7:00 TOWER DRIVE-IN

Starts SUNDAY MEET BIG CLEO and her UNDERSIZED UNDERWORLD The Little Cigars Mob WARNING! THEY ARE HAZARDOUS TO YOUR HEALTH IN COLOR AND 1,000 CONVICTS and a Woman! GATES OPEN 6:30 SHOWTIME 7:00 TOWER DRIVE-IN

WRESTLING WWA LIBRE SATURDAY JAN. 5 8:00 PM 8 MEN BATTLE ROYAL OVER THE TOPE ROPE LAST MATCH ON THE CARD MAIN EVENT BULL RAMOS vs. RICKY ROMERO

Man Mountain MIKE vs. Don FARGO Nick KOZAK vs. Alex PEREZ Leo BURK vs. El Gran TAPIA

HEREFORD BULL BARN

THE BEST FROM HOLLYWOOD! COMMONWEALTH THEATRES MOVIE MARQUEE

SPECIAL ENGAGEMENT NOW SHOWING! Marlon Brando Last Tango in Paris NO ONE UNDER 18 ADMITTED United Artists PERFORMANCE SCHEDULE: 7:30 & 9:50 STAR 364-2037

Starts TONIGHT! Burt Reynolds is The Man Who Loved Cat Dancing. THE MAN WHO LOVED CAT DANCING ALL COLOR PROGRAM! PLUS ROD STEIGER JAMES COBURN WILL BLOW YOU APART! A FISTFUL OF DYNAMITE GATES OPEN 6:30 SHOWTIME 7:00 TOWER DRIVE-IN

Starts SUNDAY MEET BIG CLEO and her UNDERSIZED UNDERWORLD The Little Cigars Mob WARNING! THEY ARE HAZARDOUS TO YOUR HEALTH IN COLOR AND 1,000 CONVICTS and a Woman! GATES OPEN 6:30 SHOWTIME 7:00 TOWER DRIVE-IN

SELL IT FAST! BUY IT RIGHT! USE WANTADS!

Phone 364-2030

CLASSIFIED ADVERTISING RATES

Readers Ads (Minimum 10 words) 1st insertion per word 10c
Additional insertions, when paid in advance: per word 8c

Classified Display (8 pt. type under a specific heading, 1 column width only — no art or signature cuts) per col. inch \$2.00
Repeat insertion without copy change per col. inch \$1.50
Display Advertising Not Classified under a heading, but placed on the classified page per col. inch \$1.50

Deadline for Classified Advertising in the SUNDAY BRAND. 5 p.m. Friday

Deadline for Classified Advertising in the HEREFORD BRAND. 5 p.m. Tuesday

1. FOR SALE Miscellaneous

TOWN & COUNTRY MOBILE HOME SALES
Hwy 60 & MYRTLE
Phone 364-0189
Also spaces & furnished trailers for rent at

TOWN & COUNTRY ESTATES
1B-1-23-9p

"THE SADDLE HOUSE"
COMPLETE Riding Equipment
New & Used Saddles
HIGGINS & SOUTH TEXAS ST.
PHONE 364-7083 1B-1-5-11c

"CARPET!"
Financing Available

CARPET
PLAINS AND N. 20 MILE AVE.
PHONE 364-7083 B-3-10-11c

WE BUY AND SELL USED FURNITURE BARRICK FURNITURE WEST HWY 60 PHONE 364-3552 1B-37-4fc

GARAGE EQUIPMENT NEW & USED
Air Compressors; Valve Machines, Steam Cleaners, etc.

BOYD MACHINE & SUPPLY
1306 East Park
Phone 364-1055 1B-1-9-11c

RCA WHIRLPOOL commercial ICE MAKERS — Sales and Service — Browned Sheet Metal. 1B-11-52-4fc

FOR SALE
1-21" Color Console TV
1-19" B&W Portable
WE MAKE HOUSE CALLS
Repairs on all makes & models, color, B&W and radios.

TOWER TV
248 Northwest Drive
Phone 364-4740 1B-1-5-11c

New Singer Dealer in Hereford. Sewing machines and vacuum cleaner repair. All makes. Free estimate in advance. Work done by Singer trained mechanics. Scissors sharpened. Call 364-4051. Sanders Sewing Machine Center, 226 Main, Hereford. 1B-1-4-11c

For Sale: 250 small beef type calves. Call Pete or Terry Caviness, 364-0900. 1B-1-12-51-4c

STATED MEETING
SECOND MONDAY
7:30 P.M.
Thursday
DEGREE WORK
Charlie Brown W.M.
W.A. Phipps Sec.

Hereford Rotary Club
meets every Monday at 12:05
Civic Club Center (Jim Hill)

Lions Club
meets each Wednesday, 12 Noon
Civic Club Center (Jim Hill)

FOR SALE: AKC Registered Wire Fox Terrier Puppies. Six Weeks Old. Call 364-0199.

FOR SALE
Registered Apaloosa horses. Bred Apaloosa fillies, Apaloosa Stallion — 10 years old and gentle to ride and a good cow horse (Grandson of Whistle Breeches)

J.A. Crawford
Phone 364-0952 1B-1-20-11c

Oak firewood for sale: 209 Kibbe. Call 364-6919. 1B-1-10-26-2p

LEFT IN LAY-AWAY
Electrographic Component Stereo with built-in tape player. AM-FM Multiflex Radio, Garrard Turntable, 200 watts, 10 speaker. Original price \$399.95. Assume balance of \$245.00 or \$10.00 monthly payments

at **MARTENS SOUND CENTER**
Corner of Georgia & I-40 in Wolfen Square, Amarillo 1B-1-31-11c

KIRBY VACUUMS
Rebuilt with genuine Kirby parts.
\$69.95 & up.
2 year guarantee
Your only authorized Kirby Distributor.
Kirby Sales & Service
522 Irving
Phone 364-0422 1B-1-35-11c

WATER BEDS
Southwest Carpet, 209 Park Avenue. Phone 364-1763. 1B-1-41-11c

See Our Line Of Bargains On new and used furniture and appliances
Open week days 9 to 12 1 p.m. to 6 p.m. Sat. 8 to 8
BIG JIM'S FURNITURE
Higgins & So. Texas St.
Phone 364-1873 1B-1-19-11c

Fireplace wood for sale. Call 364-2111. 1B-1-10-46-11c

For Sale: Westinghouse built-in dish washer harvest gold. \$75.00. Phone 364-2520. 1B-1-11-48-11c

For Sale: White German Shepherd Puppies. Perfect Christmas gifts. Call Johnny Rickman 276-5822. 1B-1-12-50-11c

FOR SALE:
1-Heiser Broncho Riding Saddle.
1-Big sorrel mare, gentle enough for anyone to ride who can pull back on the reins and say WHOA.

THE SADDLE HOUSE
Higgins & South Texas
Phone 364-3583 1B-1-27-11c

For Sale: Two registered male beagles. Phone 266-3337. 1B-1-27-11p

To give away black and white collie pups.
809 Sunset
1B-1-10-27-2c

NEW FURNITURE
1-Stereo, Console with China Hutch, reg. \$499.95, now \$399.95.
1-Quadraphonic Component set, reg. \$525.95, now \$469.95.
New living room suits as low as \$179.95
New recliners as low as \$79.95.

PLAINS FINANCE CORPORATION
906 So. 25 Mile Avenue
Phone 364-3400 1B-1-49-11c

For Sale: English Pointer Pups. Good breeding, 8 weeks old. Females \$35.00, Males \$50.00. Call 364-6800. 1B-1-16-27-2c

FULLER BRUSH PRODUCTS.
Good personal service. Mrs. Jessie Fuller, 258-7228. 1B-1-27-4fc

THE amazing Blue Lustre will leave your upholstery beautifully soft and clean. Rent electric shampooer \$1.
Hereford Hardware
1B-1-19-27-2c

For sale: Zenith color TV, Early American console, maple twin bed with mattress, box springs. 289-5810. 1B-1-10-24-11c

For Sale: 1971 Honda. \$200.00. Call 276-5821 after 5:00 p.m. 1B-1-10-49-11c

1972 Kawasaki Racer, 250 cc. Good condition. Call 357-2344. 1B-1-10-23-11c

For sale: Packard-Bell coffee table stereo. Call 364-0700; 364-2707 after 5:00 p.m. 1B-1-12-25-11c

Model 12 Winchester, 3" mag. \$140.00. 788 Remington, 243 Cal. with 3 to 9 variable scope. \$85.00.
Call 289-5951
1B-1-19-25-11c

HAYGRAZER Heavy grain, 4000 bales. Johnson grass, 3500 bales. \$50.00 per ton: 364-0484 1B-1-51-4c

CAKPETS a fright? Make them a beautiful sight with Blue Lustre. Rent electric shampooer \$1.
McCaslin Lumber
1B-1-19-1-2c

Oak fire wood for sale. Phone 364-5264 after 5:00 p.m. 1B-1-10-1-11c

For Sale: 4 months old Brittany Spaniel Puppies. Registered AKC. Call 364-1717. 1B-1-12-1-11c

For Sale: Used gas dryer. Excellent condition. Call 364-5746 after 6:00 p.m. 1B-1-11-1-11c

For Sale: Go-Kart-McCullach Powered. Call 364-5780 after 4:00 p.m. 1B-1-10-1-11c

GARAGE SALE. Wednesday through Saturday. Large sizes men-women clothes, misc. bike, misc. One Block West of Big Daddy's. Mrs. J.F. Messer. 1B-1-1-11p

BE gentle, be kind, to that expensive carpet, clean it with Blue Lustre. Rent electric shampooer \$1.
Duckwalls, Sugarland Mall
1B-1-21-1-2c

2. FOR SALE Farm Equipment
For sale: 40 ft. flat trailer, and 1957 Ford dump truck. Call 364-2530. 1B-1-13-24-11c

See Us For **Parts-Sweeps-Chisels** for **Graham (Hoeme) Plows DAVIS IMPLEMENT**
409 EAST FIRST
Phone 364-2811 1B-2-35-4fc

See Us For **Mayrath Grain Augers** Also have parts in stock **DAVIS IMPLEMENT**
409 EAST FIRST
Phone 364-2811 1B-2-35-4fc

Diesel tanks - 2000 to 18,000 gallons. Pressure tanks - 100 to 6000 gallons. 364-0484. 1B-2-51-4c

For Sale: Oswalt Manure Spreader for tandem truck. Excellent condition. Call 806-364-0938
Wayne Carthel
Leola Peters
1B-2-13-51-11c

3. FOR SALE Automobiles

1971 Ford 1/2 ton. Power & air. 40,000 miles. New steel belted tires. Sale or trade for older pickup. Call 364-3484. 1B-3-21-48-11c

MILBURN MOTOR COMPANY
We pay cash for Used Cars
136 Sampson
Phone 364-0677 1B-3-33-4fc

Going overseas — must sell 1973 Cutless Supreme maroon and white 'Olds. Bucket seats, automatic transmission, factory air, low mileage. Call 364-1110 or 364-1302. 1B-3-23-51-11c

WALKER'S USED CARS AND TRUCKS
WE BUY, SELL OR TRADE
400 West First
Phone 364-2250 1B-41-4fc

SELECTED USED TIRES \$3.00 UP
30 Day Guarantee
MONTGOMERY-WARD AUTOMOTIVE SALES
114 EAST PARK
1B-3-17-4fc

NEW & USED CARS
ORVAL WATSON FORD
PHONE 364-2727 1B-3-18-4fc

Used Chevy Pickup for sale. See at 1515 Avenue K or call 364-0210. 1B-3-13-27-2c

1971 Ford 1/2 ton Pickup. V8. Automatic, excellent condition. Phone 364-5324 after 7:00 p.m. 1B-3-13-27-2c

For Sale: 1970 Maverick. Good gas mileage. Good condition. Call 289-5936 after 6:00 p.m. 1B-3-27-2p

1967 Chevy 2, six cyl. Call or come by, 364-1170, 904 E. 3rd. 1B-3-12-1-11c

4. REAL ESTATE For Sale Or Trade
For Sale By Owner
Large double wide mobile home. 24x50. 3 bedrooms, 1 1/2 baths; large lot 85x119 - 6 ft. fenced backyard with fruit trees, patio, 11x11 playhouse, wood burning fireplace, gas grill and light. Priced to sell. Call 364-2423 1B-4-30-4fc

LAND
60 acres with a well. Good farmland, at \$325.00 per acre. Carthel Real Estate
Phone 364-0944 1B-4-43-4fc

I have Farm and Ranch Buyers; I need your listings.
J.M. HAMBY REAL ESTATE
Phone 364-3566
Res. 364-2553 1B-4-29-4fc

REPOSESSION
\$14,950.00 — 3 bedroom, 1 1/2 baths, attached garage, carpeted, built-in range. Total move-in cost less than \$500.00.
437 AVENUE C
Move in cost less than \$500.00. New FHA Loan. 1B-2-13-24-11c

5 UNIT APARTMENTS
Good location, good income.
LOANS
Let us help you with your financing FHA-VA & CONVENTIONAL LOANS are now available. Check with our office for details.

TWO BEDROOM
Carpeted with finished room and garage. Fenced yard. \$9,500.

THREE BEDROOM
Carpeted, double car garage. On Labor Camp Road. \$9,000.

Board of Realtors Multiple Listing Service
CARTHIEL REAL ESTATE
206 N. 25 Mile Avenue
Phone 364-0944
364-0938
Wayne Carthel
Leola Peters 1B-4-10-11c

For sale by owner: large 2 bedroom house, very large double garage. Well insulated, low gas consumption. Phone 364-1483 or 364-3037. 1B-4-19-24-11c

CLOSED ON SUNDAYS

"Yes, we're open on Sundays — that's just the title of this week's show."

LET'S MAKE A DEAL on this 3 bdrm. 2 baths, carpet, built-ins, utility room, double garage. This home is about 3 yrs. old and has an isolated master bedroom. Priced \$18,500.00 with \$1,000.00 down.

CLOSE TO SCHOOL & SHOPPING CENTER
3 bdrm. 1 1/2 baths, single garage, all built-ins. Buy equity and assume payments of \$151.00 per month.

ONE OF THE PRETTIEST ON MIMOSA STREET
3bdrm. brick 2 1/2 baths, den and kitchen comb. dining room, living room, ref. air, 2 fireplaces, \$2,000.00 worth of drapes. Double garage with electric door lift. Built-in vacuum deaner, patio with bar-b-que grill, gas lites front and back. 5 1/4 per cent loan. Buy equity and assume payments of \$236.00 per mo.

CLOSE TO TOWN & HOSPITAL
2bdrm. with 1 bath, living room dining room, fully carpeted, single garage, fenced yard. Priced \$11,500.00 with \$1,500.00 down and payments you can afford.

IMMEDIATE POSSESSION
Northwest 3 bdrm. brick, den and kitchen comb. Formal living room, 2 full baths, double garage, fully carpeted including baths and kitchen. Price \$23,500.00. Assume existing loan, approx. \$16,600.00 and pay \$176.02 per month. Owner will sell for \$3,000.00 down and carry 2nd or will trade for smaller home or clear mobile home.

SMALL EQUITY
2 bdrm., 1 bath, new carpet, fenced yard. Just right for a couple who are wanting to get a start in life. Buy equity and assume payments at \$96.00 per month.

WANT A GOOD INVESTMENT?
This duplex on 3rd Street is furnished and is in good shape inside and out. Priced at \$15,000.00 and you can buy this one for \$2,000.00 down and \$125.00 per month. It is rented for \$160.00. How can you lose?

1.7 ACRES OVER-LOOKING GOLF COURSE
Ideal for nice mobile home spaces or for a nice apartment house. 2 bdrm. rent house goes with land. Priced for \$16,000.00. Terms available.

1600 ACRES, DEAF SMITH COUNTY
Approx. 550 acres cult., 7 small irr. wells, ideal cattle operation. Price \$157.50 per acre. Terms available.

We have some small tracts and some farms for sale. If you don't find the home or farm you need, we may have it or can find it for you.

HAMBY REAL ESTATE OFFICE
Calvin Edwards — 364-3566
Gerald Hamby — 364-1534
Chick Weemes — 364-3169
J.M. Hamby — 364-2553

EQUAL HOUSING OPPORTUNITY
For sale by owner: large 2 bedroom house, very large double garage. Well insulated, low gas consumption. Phone 364-1483 or 364-3037. 1B-4-19-24-11c

DIAMOND VALLEY MOBILE HOME PARK
600 & 700 Block Avenue H, Sioux & Cherokee, 700 Block Avenue G.
Phone 364-1483 or 364-3037 1B-5-50-11c

FOR LEASE OR SALE
Commercial building (8,000 sq. ft.) Prime location corner Main and 2nd St. Hereford, Texas. Priced to sell (Financing available at 7 1/2 per cent). Call Collect for details:
Geo. Masbo:
512-682-6191 or 512-682-8091. 1B-5-1-10c

FOR RENT; 3 bedroom house 2 miles out. Call 364-0669. 1B-5-1-10c

FOR RENT: 3 bedroom house one-half block from Aikman School. \$185.00 per month; one month in advance, \$150.00 deposit. Phone 364-0128. 1B-5-22-1-2c

FOR RENT: 3 bedroom house one-half block from Aikman School. \$185.00 per month; one month in advance, \$150.00 deposit. Phone 364-0128. 1B-5-22-1-2c

WHY PAY OUTRAGEOUS PRICE FOR YOUR APARTMENT?

We have apartments to suit your needs in any size. Your rent is adjusted to your income so you will not be paying more than you can afford. Apartments have stove, refrigerator, garbage disposal, central heat and air and fenced playgrounds, laundry facilities, recreation room, free cable vision.

1 bedroom start \$79.95
2 bedrooms start \$101.35
3 bedrooms start \$113.75
4 bedrooms start \$132.00
All bills paid. Deposit is required.
BLUE WATER GARDEN
412 Irving
Phone 364-4441 3B-5-2-11c

FOR LEASE OR SALE
Commercial building (8,000 sq. ft.) Prime location corner Main and 2nd St. Hereford, Texas. Priced to sell (Financing available at 7 1/2 per cent). Call Collect for details:
Geo. Masbo:
512-682-6191 or 512-682-8091. 1B-5-1-10c

FOR RENT; 3 bedroom house 2 miles out. Call 364-0669. 1B-5-1-10c

FOR RENT: 3 bedroom house one-half block from Aikman School. \$185.00 per month; one month in advance, \$150.00 deposit. Phone 364-0128. 1B-5-22-1-2c

6. WANTED
CONTRACT GROWERS WANTED
Must have 10-50 acres irrigated land. Grow new high volume, high protein forage for feed and seed. \$3,000 to \$15,000 investment for earning potential of \$50,000 to \$100,000.
Write Box 3284
Arlington, Texas
Phone 817-274-3003 (Sunday-Friday) 1B-6-50-8c

5. FOR RENT
MOBILE HOME SPACE for rent. Call 276-5333. 1B-5-10-3-11c

TRAILER SPACE FOR RENT
Northwest Mobile Lodge,
Phone 364-1108 1B-5-10-13-11c

BEDROOMS BY THE WEEK
Plains Motel. 1B-5-23-9p

Small two bedroom trailer house for rent. Phone 364-4553 or 220 North 25 Mile Avenue. 1B-5-15-27-11c

For Rent: 3 room house, partially furnished. Call 364-4917 after 4:00 p.m. 1B-5-27-2p

For Rent: Trailer space at 217A Avenue A. Paved street and drive. Phone 364-4553. 1B-5-14-27-11c

APARTMENTS, FURNISHED
1 and 2 bedrooms with kitchen, dinette and bath. Also 2 bedrooms, living room, kitchen, dinette and bath.
FORREST AVENUE APARTMENTS
Phone 364-1887 1B-5-4-4fc

FURNISHED one and two bedroom apartments. Inquire, 112 Avenue H, Apt. 36. 1B-5-12-46-4fc

Unfurnished one bedroom duplex. Bills paid, couple only, no pets. References needed. Phone 289-5757. 1B-5-14-48-11c

SUMMERFIELD MOBILE MANOR
FIRST MONTH FREE. 7 miles West on Hwy. 60. Phone 357-2552. 1B-5-15-10-11c

OFFICE FOR LEASE. Ralph Owens 364-2222. 1B-5-10-14-11c

Office for rent. Answering service available. **AGRI-SCIENCE CENTER**, 1500 West Park, Phone 364-5822. 1B-5-14-19-11c

Thunderbird Apartments. Unfurnished 2 bedroom, 1 1/2 bath, Phone 364-5360 1B-5-13-19-11c

For Lease: Old Lockwood Grader Building. Contact S.T. Wiseman 364-1752 or 258-7295 or Leroy Williamson, 364-1933. 1B-5-14-51-11c

Storage for rent. Phone 364-1483 or 364-3037. 1B-5-10-50-11c

MISSOURI BEEF PACKERS INC.

is now accepting applications for beef loggers, production workers, maintenance men and kill floor personnel.

We offer:
+Year around employment
+Paid vacations
+Paid holidays
+Company paid group Hospital insurance
+Good wages
+No experience necessary

Apply at Personnel Office of Missouri Beef Packers Inc., Friona, Texas, 4 miles West of Friona on Hwy. 60.

We are an equal opportunity employer. 1B-8-15-51-4c

Hide room labor wanted. We offer:
+Good pay
+Paid vacation
+Paid hospitalization
Colorado By-Products
3 1/2 miles West Hwy 60
Phone 276-5331 days;
364-2495 nites 1B-8-42-11c

Need man experienced in farm work with small family. Good salary and housing. Call 296-3432. 1B-8-15-51-4c

WANTED - FARM MANAGER
2500 acres irrigated, mostly alfalfa. Bilingual. Agricultural degree or equivalent. Excellent opportunity for person willing to assume complete responsibility. 505-67-2503. 1B-8-51-4c

We have openings for pellet mill and batch mixer operators. Experience preferred, but not required. Apply in person or call Hi-Pro Feed, Friona, Texas 806-247-2791. 1B-8-25-25-5c

Couples work together building a business. Start part time and grow. We train. Phone for interview. 364-2329 after 6:00 and weekends. 1B-8-21-26-11c

Need farm hand. Must be able to irrigate and handle tractors. Call George Ritter, 289-5826. 1B-8-14-26-3c

NEED PAPER BOYS APPLY AT THE HEREFORD BRAND 1B-8-44-11c

MISSOURI BEEF PACKERS, INC. is now accepting applications for female production workers. No experience necessary, but must be willing to learn and work. This is year around employment, not seasonal. We offer:
+Paid vacation
+Paid holidays
+Company paid group hospital insurance
+Good wages

Apply at Personnel Office of Missouri Beef Packers, Inc. Friona, Texas, 4 miles West of Friona on Hwy 60. We are an equal opportunity employer. 3B-8-14-11c

RN or LVN charge nurse needed for 11:00 to 7:00 shift. Apply in person Kings Manor-Westgate. 1B-8-16-39-11c

Wanted: Two ladies with car 2 hours, 5 days, \$60.00 per week. Call Norma Villarreal, Stanley Home Products, 364-6570. 1B-8-19-1-4c

Full time electrician's helper. Experience preferred. Phone 364-6841. 1B-8-10-1-2c

FEED MILL MANAGER WANTED
Must know mill operation and rations for cattle. Prefer bilingual. 25,000 head capacity Southeastern, New Mexico feedlot. Salary commensurate with experience and ability to assume responsibility.
Call 505-67-2503 1B-8-51-4c

School bus drivers needed. See Eldon Owens at school bus shop. 276-5235 or 276-5251. 1B-8-10-17-11c

9. SITUATIONS
Baby sitting in my home. Will give TLC. 238 Hickory. 364-4288. 1B-8-11-51-11c

Freightliner Driver. \$250.00 per week. 10 years California long haul required. 876-2442. 1B-8-51

The Hereford Brand, Hereford, Texas, January 3, 1974
Will do baby sitting in my home. Nice neighborhood. Drop-ins welcome. 364-2135. B-9-13-27-6c

Baby sitting in my home. Phone Alice Gilleland, 364-4175. B-9-10-26-tfc

WANTED: Baby sitting. Call 364-2149 B-9-10-23-9c
State Licensed Child Care For Working Mothers Hereford Day Care Center 364-1293 B-9-46-tfc

10. NOTICE

For the convenience of you, our customers, we now have truck scales to weigh your scrap iron — One mile North of Big Daddy's Truck Stop. HEREFORD IRON & METAL North Progressive Road by City Dump Anson A. & June Dearing Phone 364-3750 or 364-3777 1 1/2 B-10-34-tfc

ALCOHOLISM INFORMATION

For information on alcoholism, referrals for help, counseling, or programs on the subject of the disease of alcoholism, Call 364-4540 from 8:00 a.m. till 12:00 p.m. until 5:00 p.m. Monday through Friday. A UNITED FUND AGENCY B-10-12-tfc

ENROLLING NOW FOR LESSONS IN OIL PAINTING Beginning JANUARY 14th Small classes, Individual attention PETERSEN STUDIO Phone 364-3198 B-10-1-4c

11. BUSINESS SERVICE

AAA WRECKER SERVICE HEREFORD WRECKING COMPANY Day Phone 364-6380 NIGHTS 364-6009 and 364-6075 T-11-39-11c
APPLIANCE REPAIR We repair all makes and models of appliances. All work guaranteed. MONTGOMERY WARD & CO. 114 East Park Phone 364-5801 B-11-52-tfc
JIM MANNING PLUMBING is back and ready to do your job — large or small. Phone 364-0931 We specialize in repairs B-11-27-2c

DON'T TOSS IT — REGLOSS IT. Furniture repaired and refinished. Call Tom Tompkins, 806-287-5831 collect. B-11-27-100
Tree Trimming and Topping. Call Cliff's Tree Service 364-2111. B-11-10-46-tfc

B.L. Jones CONCRETE CONTRACTOR We will do your finishing or give you a turnkey job. Free Estimates. 246 16th Street Phone 364-6617 B-11-21-tfc

DICKEY'S DOZER SERVICE Dirt Work — All Kinds Bull dozers — Scrapers — Back Hoe — Dragline Motorgrader See or Call FLOYD DICKEY S.E. 4th & Belsher Dimmitt, Texas Business Phone 647-4553 Residence Phone 647-4565 B-11-29-tfc

WILL PICK UP JUNK CARS. FREE. Call 364-3350 or 364-3777 1B-11-29-tfc

HOME APPLIANCE REPAIRS Guaranteed work on all makes and models. 10 years experience. Available for night-time emergencies. JOE'S HOME APPLIANCE REPAIRS 343 N. Main Ph. 364-5751 B-11-45-tfc

KIRBY VACUUMS Rebuilt with genuine Kirby Parts. \$59.95 & up, two year guarantee. Your only authorized Kirby Distributor. Kirby Sales & Service 114 East Park Ph. 364-4422 1B-11-35-tfc

FRANK WESTER CEMENT CONTRACTOR 187 BRADLEY Residential-Commercial Turnkey Job Straight finish Phone 364-5169 1B-11-30-tfc

CUSTOM GRINDING New Moeller Tub Grinder. Burrs, baled hay, ear corn, grain, manure. Call Russ Henninger, 806-376-9702 1B-11-23-9p

WANTED 100 to 150 watches a week to repair by latest approved methods. COWAN JEWELERS B-11-15-29-tfc

DRAGLINE SERVICE TAILWATER PIT CLEANING DUMP TRUCKS 30 ton crane. BOBBY GRIEGO Day Phone 364-0574 Night — 364-2322 1B-11-14-tfc

KELLY ELECTRIC DOUG AND VIRGIL Electrical Contractors Residential Commercial All bids and wiring Call bids and wiring competitive. Phone 364-1345 Night phone 364-2912 or 364-1345 Box 139 B-11-46-tfc

13. LOST & FOUND

LOST: Drawers from an antique chest. Reward. Call collect - Plainview 293-3963. B-13-11-27-2c
STRAYED: Two steers or heifers from Northwest of Hereford. Branded "D7" on right leg, yellow tag in right ear. Call 364-6399 or 276-5857. B-13-23-27-3c
LOST: German Shepherd Dog. Tan head and chain collar. Answers to "Tramp". Reward. Call 364-1779. B-13-15-27-3c

CARD OF THANKS The family of Ervin Robinson, Sr., wishes to express their gratitude and appreciation to the many who called, brought food, sent flowers and made donations to the Heart Fund and the Cancer Fund. Our special thanks to the Police Night dispatcher, the patrolman who responded so rapidly and the men on the emergency unit. The Family of Ervin Robinson, Sr.

Reservations Needed In Some Parks

Need to reserve a cabin, lodge room, shelter or group facility in a state park for, say, Memorial Day next year? Better get your name in to the park superintendent between Jan. 1 and 10 because the Parks and Wildlife Department is holding a drawing at 10 a.m. Jan. 11 in the respective parks to set reservations for high-use days during the coming year. Parks and Wildlife Department officials say that only cabins, lodge rooms, shelters and group facilities may be reserved. Campsites and trailer spaces in state parks may not be reserved but are continually available on a first-come, first-served basis. Those wishing to participate in the Jan. 11 drawing must submit their reservation requests to the park superintendent where the facility is desired. Reservation requests will not be accepted by the department until Jan. 1. Additional dates should be indicated in the order of preference to insure a greater chance for obtaining a reservation. Requests for cabins must include the total number of persons in the immediate

Bad Company It's no wonder the underworld is so rotten when you observe the kind of important citizens it pals with. -Record, Chico, Calif.

Highway Missile He who travels over 60 miles an hour is not driving his car—he's aiming it. -News, Dallas.

Retirement Incomes Rise In Deaf Smith County

The number of Deaf Smith County residents who are getting Social Security checks each month from Washington continues to rise. And the amounts that are going to them are increasing as well. The latest upward revision, just acted upon by Congress, will boost their payments by 11 per cent during 1974. A total of 1,915 persons in the local area, more than ever before, are now on the receiving end. Three years ago there were 1,663.

THEY ARE benefitting from the contributions they made to the Social Security Trust Fund over the years via money deducted from their pay envelopes. The majority of the recipients are retired workers. The others include disabled workers, widows, children and other dependents. The facts and figures are contained in the latest annual report of the Social Security Administration.

THEY SHOW that the increase in the number of beneficiaries has been due, chiefly, to periodic revisions of the law. The changes have had the effect of bringing more and more people under coverage. Nationally, as a result, more than 9 out of 10 working and people now have Social Security protection. Along with the increase in the number of persons enrolled has been the big increase in the size of pension checks.

IN DEAF Smith County, the average annual payment per recipient was \$1,403 in the past year, considerably more than

the \$851 paid three years ago. The combination of more beneficiaries and bigger checks has boosted considerably the inflow of cash to the local area. The government's figures show that overall payments to local residents, as of the beginning of this year, were at the annual rate of \$2,688,000. Three years before, by way of contrast, the total was only \$1,416,000.

After Husband-What is left of a sweetheart after the nerve has been killed, -Quonset Scout.
Do They? Achievements are like trousers—they become threadbare if you rest on them. -Sunshine Magazine.
Safest The safest rule for predictions is to be indefinite about the date. Sooner or later almost anything can happen. -Labor.

the \$851 paid three years ago. The combination of more beneficiaries and bigger checks has boosted considerably the inflow of cash to the local area. The government's figures show that overall payments to local residents, as of the beginning of this year, were at the annual rate of \$2,688,000. Three years before, by way of contrast, the total was only \$1,416,000.

THEY ARE benefitting from the contributions they made to the Social Security Trust Fund over the years via money deducted from their pay envelopes. The majority of the recipients are retired workers. The others include disabled workers, widows, children and other dependents. The facts and figures are contained in the latest annual report of the Social Security Administration.

THEY SHOW that the increase in the number of beneficiaries has been due, chiefly, to periodic revisions of the law. The changes have had the effect of bringing more and more people under coverage. Nationally, as a result, more than 9 out of 10 working and people now have Social Security protection. Along with the increase in the number of persons enrolled has been the big increase in the size of pension checks.

IN DEAF Smith County, the average annual payment per recipient was \$1,403 in the past year, considerably more than

the \$851 paid three years ago. The combination of more beneficiaries and bigger checks has boosted considerably the inflow of cash to the local area. The government's figures show that overall payments to local residents, as of the beginning of this year, were at the annual rate of \$2,688,000. Three years before, by way of contrast, the total was only \$1,416,000.

After Husband-What is left of a sweetheart after the nerve has been killed, -Quonset Scout.
Do They? Achievements are like trousers—they become threadbare if you rest on them. -Sunshine Magazine.
Safest The safest rule for predictions is to be indefinite about the date. Sooner or later almost anything can happen. -Labor.

FOR QUICK REPLACEMENT OF CRACKED SAFETY GLASS Call 364-2652 HEREFORD GLASS CO. INC. For All Your Glass Needs Insurance claims promptly serviced. We use nationally advertised SAFETY GLASS

UNITED MOBILE HOMES 12' x 44' FINANCING AVAILABLE \$3885.00 E.V. CARTER ALMA CARTER 201 UNION

Ellis' TAMALES GIVES YOUR BUDGET A BREAK!

EXPERT REPAIR ON BUICK PONTIAC GMC TRUCKS JOHN ORSBORN Free Pickup phone 364-0990 HOME OWNED

Look to SHOOK For Quality LEE Tires and on the Farm & Road Service As Close As Your Phone Quality With Price - MAY WE SERVE YOU Shook Tire Co. 364-1010

NOW IN HEREFORD BELL ELECTRIC ELECTRICAL CONTRACTOR New Construction and Repair - Residence and Commercial 364-6841 Larry Bell 803 S. Texas

FOR THE BEST DEALS ON NEW or USED CARS Come in and talk with one of the Men at JOHN ORSBORN BUICK-PONTIAC-GMC at 142 N. MILES or 221 N. 25 Mi. Ave. 364-0990 364-1222

I TURNED AROUND AND IT WAS SOLD! We don't intend to make whirling dervishes of our clients, but we DO put all of our experience and facilities to work right now when you delegate the selling job to us. \$25,000. to \$35,000. HOME LISTING NEEDED NOW...CONTACT or CALL... Ralph Owens & Associates, Inc. 311 Park Avenue REALTORS Phone 364-2222

Come children of the universe, let Donovan take you away, far far away. FRIDAY & SATURDAY ALL SEATS 75¢ The Pied Piper JACK WILD DONALD PLEASANCE JOHN HURT DONOVAN THE PIED PIPER SHOWTIMES 12:30 2:10 3:55 5:35

WRESTLING WWA HERE SATURDAY JAN. 5 8:00 PM 8 MEN BATTLE ROYAL OVER THE TOPE HOPE LAST MATCH ON THE CARD MAIN EVENT BULL RAMOS vs. RICKY ROMERO Man Mountain MIKE vs. Don FARGO Nick KOZAK vs. Alex PEREZ Leo BURK vs. El Gran TAPIA

HEREFORD BULL BARN

COMMONWEALTH THEATRES MOVIE MARQUEE SPECIAL ENGAGEMENT NOW SHOWING! Marlon Brando Last Tango in Paris PERFORMANCE SCHEDULE: 7:30 & 9:50 STAR 364-2037

Starts TONIGHT! Burt Reynolds The Man Who Loved Cat Dancing. ALL COLOR PROGRAM! PLUS ROD STEIGER JAMES COBURN WILL BLOW YOU APART!

A FISTFUL OF DYNAMITE TOWER DRIVE-IN

Starts SUNDAY! MEET BIG CLEO and her UNDERSIZED UNDERWORLD The Little Cigars Mob WARNING! THEY ARE HAZARDOUS TO YOUR HEALTH AND Caged brutes in a killer frenzy LOUD CONVICTS and a Woman! TOWER DRIVE-IN

Delicatessen



SAVE MORE '74

START THE NEW YEAR SAVING AT FURR'S
WE RESERVE THE RIGHT TO LIMIT QUANTITIES

WE REDEEM USDA FOOD STAMPS
PRICES IN THIS AD EFFECTIVE THRU JANUARY 5, 1974

BANANAS
ORANGES
APPLES
NUTS

LETUCE
CALIFORNIA ICEBURG, LB. **20¢**
CARROTS
1 LB. CELLO PKG. EACH **15¢**
GRAPEFRUIT
TEXAS RUBY RED LB. **14¢**
GOLDEN RIPE LB. **11¢**
FANCY CALIFORNIA NAVEL, 8 LB. BAG **\$1.09**
RED OR GOLDEN DELICIOUS OR RED ROME, YOUR CHOICE, LB. **28¢**
ALL VARIETY LB. **69¢**

HALIBUT STEAK SQUARES
\$1.29 LB.

BEEF PATTIES FROZEN
89¢ LB.

DELUXE RIBS FOR BAR-B-Q
FURR'S PROTEN, LB. 69¢

BACON
99¢ LB.
Farm Pac 1 Lb. Frontier 1 Lb. Farm Pac Sliced Slab
NO SALES TO DEALERS

ROUND SIRLOIN RIB STEAK CLUB STEAK T-BONE CUBE STEAK RUMP ROAST SWISS STEAK

ALL FOR \$1.69
½ FRIED CHICKEN
½ PT. CLOE SLAW
½ LB. POTATO SALAD
BAKED BEANS Pt. 69¢
MACARONI SALAD Pt. 69¢
FURR'S PROTEN STEAK, LB. \$1.19
FURR'S PROTEN, STEAK, LB. \$1.19
FURR'S PROTEN, LB. \$1.19
FURR'S PROTEN, LB. \$1.39
FURR'S PROTEN, STEAK, LB. \$1.49
FURR'S PROTEN STEAK, LB. \$1.49
FURR'S PROTEN, LB. \$1.13
ROUND BONE ARM FURR'S PROTEN, LB. \$1.13

SPAGHETTI FRANCO AMERICAN 15-OZ. CAN **5 FOR \$1.00**
HANDI-WRAP 200 FT. ROLL **49¢**
CORN FOOD CLUB, CREAM STYLE OR WHOLE KERNEL GOLDEN, NO. 303 CAN **4 FOR 88¢**
GREEN BEANS FOOD CLUB WHOLE NO. 303 CAN **4 FOR \$1.00**
PRUNE JUICE FOOD CLUB QUART JAR **49¢**
PEANUT BUTTER FOOD CLUB CREAMY OR CRUNCHY 18-OZ. **59¢**
PEAS FOOD CLUB SWEET NO. 303 CAN **4 FOR \$1.00** **PAM SPRAY 13-OZ. \$1.25**
GELATIN FOOD CLUB, ASS'T. FLAVORS 3-OZ. PKG. **10¢**
COCA COLA OR 7up 32-OZ. **6 FOR \$1.25**
CHUNK STYLE TUNA FOOD CLUB LIGHT, NO. ½ CAN **49¢**

DOUBLE GOLD BOND
Double Tues. & Wed. with \$2.50 purchase or more

Frozen Food Favorites

CUT CORN WHOLE KERNEL GAYLORD FRESH FROZEN, 24-OZ. **49¢**
CUT BROCCOLI TOP FROST-FRESH FROZEN, 20-OZ. PKG. **58¢**
POTATOES GAYLORD FRENCH FRIED, 5-LB. **99¢**
TOPPING FOOD CLUB 8-OZ. PACKAGE **39¢**
INSTANT POTATOES FOOD CLUB 13-OZ. **39¢**

ART LINKLETTER'S MONEY-SAVING SUGGESTION!

TOPAZ STONEWARE

THIS WEEK DINNER PLATE Regular Price 79¢ **49¢** each

START NOW - COLLECT A FULL SET

Safe in oven and dishwasher... and so smart!

CAKE MIX FOOD CLUB ASSORTED BOX **3 FOR 99¢**
INSTANT COFFEE FOOD CLUB 13-OZ. **39¢**

THIS COUPON ENTITLES YOU TO **SAVE 50¢ FOLGER'S COFFEE**
3-LB. CAN, With Coupon \$2.75 Without Coupon \$3.25
Expires 1-5-74
LIMIT ONE COUPON PER FAMILY

THIS COUPON ENTITLES YOU TO **SAVE 25¢ IVORY LIQUID**
32-OZ. With Coupon 64¢ Without Coupon 89¢
Expires 1-5-74
LIMIT ONE COUPON PER FAMILY

THIS COUPON ENTITLES YOU TO **SAVE 40¢ INSTANT COFFEE**
FOLGER'S 10-OZ. JAR With Coupon \$1.29 Without Coupon \$1.69
Expires 1-5-74
LIMIT ONE COUPON PER FAMILY

CHILI BOWL OLD FASHION STYLE EXCELLENT THERMAL QUALITIES OVEN PROOF, DISH WASHER SAFE EA. **49¢**

COFFEE MUG IRONSTONE BROWND RIP KEEPS COFFEE WARM LONGER **49¢**

STORAGE CONTAINER ANCHOR HOCKING OLD FASHION ½ GAL. SIZE GLASS LID NO. 348E **\$1.79**

BABY SHAMPOO TOPCO 16-OZ. **49¢**

PEPTO-BISMOL 8-OZ. SIZE **94¢**

DENTU-CREAM TOOTH PASTE WERNET'S ECO. **79¢**
ASPIRIN BAYER'S CHILDREN 36-COUNT **29¢**

SANITARY TAMPONS KOTEX, BOX OF 40 COUNT REG. OR SUPER **99¢**

STORAGE BOX BIG 24½" x 14 3/8" x 10 5/8" SIZE REINFORCED HANDLES, EA. **99¢**

CORNBREAD SKILLET LODGE HEAVY CASTIRON WEDGE SHAPE MAKES CRUSTY BREAD-EVERYTIME EACH **\$1.99**

VAPORUB VICK'S 3.1-OZ. JAR **89¢**

Balm Barr PURE ORGANIC VITAMIN SKIN CARE OIL ½-OZ. SIZE **\$2.10**

SHOP Furr's MIRACLE PRICES

Supplement to THE HEREFORD BRAND, Thursday January 3, 1974, Hereford, Texas

Sale. 25% off our entire line of knit fabrics. Sew and save.

Save \$1 yard

Reg. 3.99. Sale 2.99 yd. Polyester doubleknits in your choice of crepe stitch solids and smart plaids. Also a wide range of fancy coordinatates. Machine wash, tumble dry. 58/60" wide.

Sale prices effective thru Saturday. Charge it.

Special 77¢

4 oz. skeins of Creslan® acrylic yarn in a wide variety of fashion colors.



Special 99¢

Polyester marquisette tailored panels with 3" bottom hems. Available in 40x63" or 40x81" sizes. White.



Our wildest white sale ever. Save on these beautiful JCPenney sheets.

Grab your charge and charge or use our convenient lay-away.

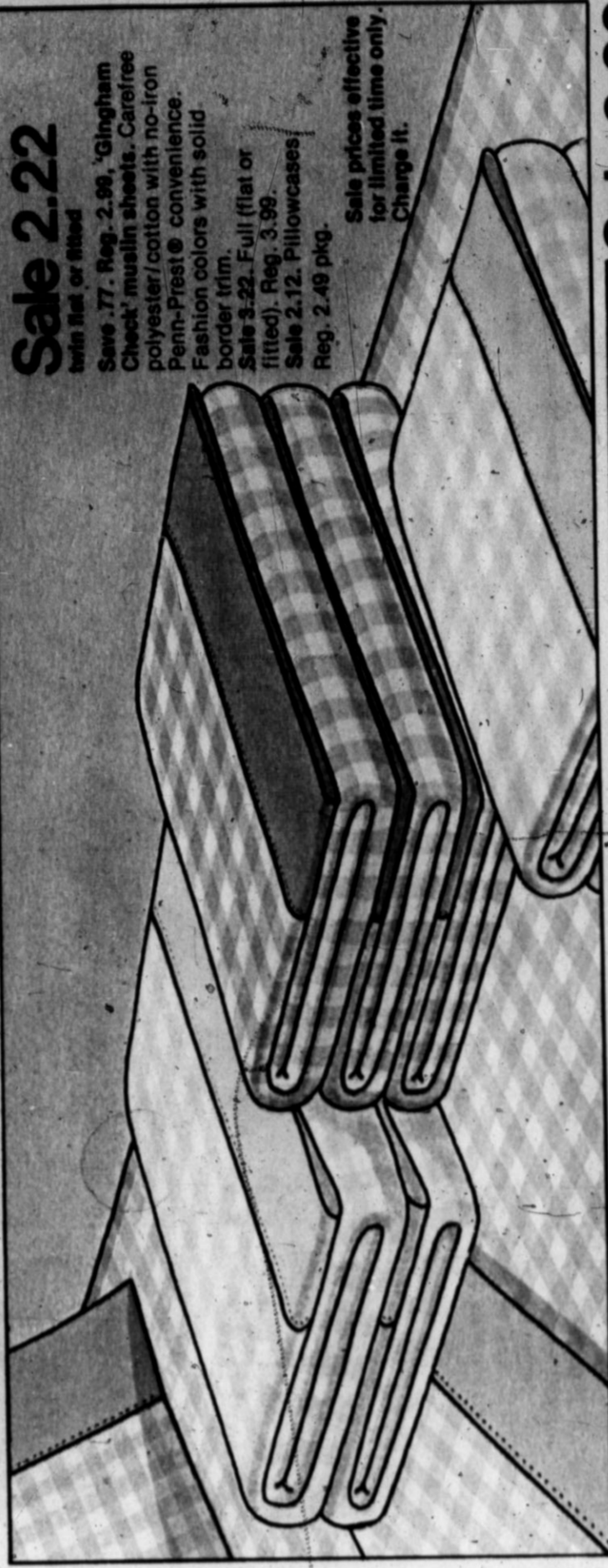

Sale 2.22

Save .77. Reg. 2.99. Gingham Check muslin sheets. Carefree polyester/cotton with no-iron Penn-Prest® convenience. Fashion colors with solid border trim. Sale 3.22. Full (flat or fitted). Reg. 3.99. Sale 2.12. Pillowcases. Reg. 2.49 pkg.

Sale prices effective for limited time only. Charge it.

Sale 2.22

twin flat or fitted

Save .77. Reg. 2.99. Long solid muslins. Long wearing blend of polyester/cotton. Beautiful choice of decorator colors. Sale 3.22. Full (flat or fitted). Reg. 3.99. Sale 2.12. Pillowcases. Reg. 2.49 pkg.

Sale 2.22

twin flat or fitted

Save 1.27. Reg. 3.49. 'Parisienne' muslin print sheets. Delicate bouquet of flowers on a white ground. Polyester/cotton. Sale 3.22. Full (flat or fitted). Reg. 4.49. Sale 2.12. Pillowcases. Reg. 2.99 pkg.

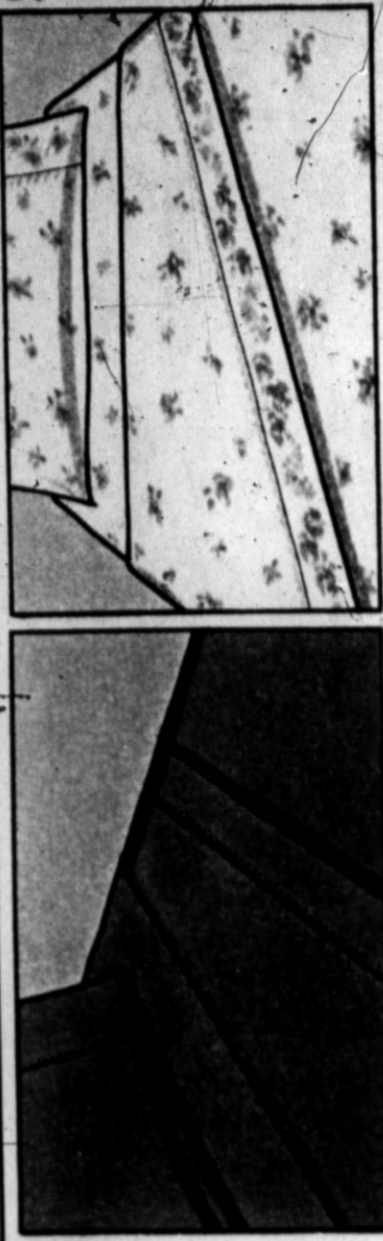

JCPenney

We know what you're looking for.

Starts THURSDAY

JANUARY 3

HEREFORD, TEXAS
436 Sugarland Mall
9:30 am til 6:00 pm
Saturday 9:30 am til 6:00 pm

JCPenney

We know what you're looking for.

HWY 385N. OPEN DAILY 8:00 A.M. to 8:00 P.M.

ILLUSTRATION BY BULL

Save on our famous white muslin sheets. Curtain sale.

Sale 166 twin flat or fitted

Reg. 2.19. Penn-Prest® white muslin sheets in a long wearing blend of polyester/cotton. Never need ironing. Just say "charge it" and fill your linen closet now, or put them in convenient lay-away.
Sale 2.26. Full flat or fitted, reg. 2.79.
Sale 2 for 1.26. Pillowcases, Reg. 2 for 1.39.



2 for 388

Polyester filled, full finished bed pillows at a super price: 20x26 with cord edges. Printed top, solid bottom.

Sale prices effective for a limited time only. For additional values on bedding items, see our JCPenney's Catalog. Charge it.

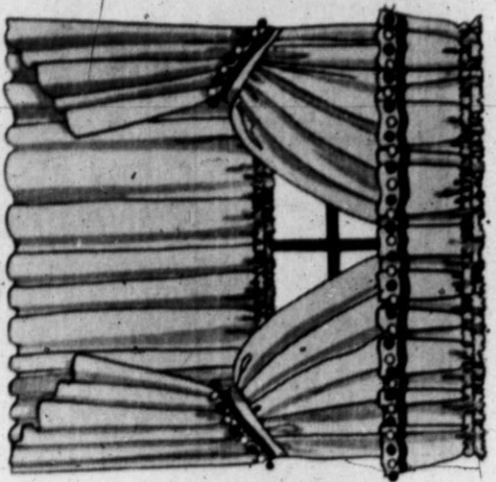

Sale 239

Reg. 2.99. 'Pamela' is Penn-Prest® rayon sharkskin with colorful ball fringe. 68x36". Valance, reg. 2.59. **Sale 2.07**

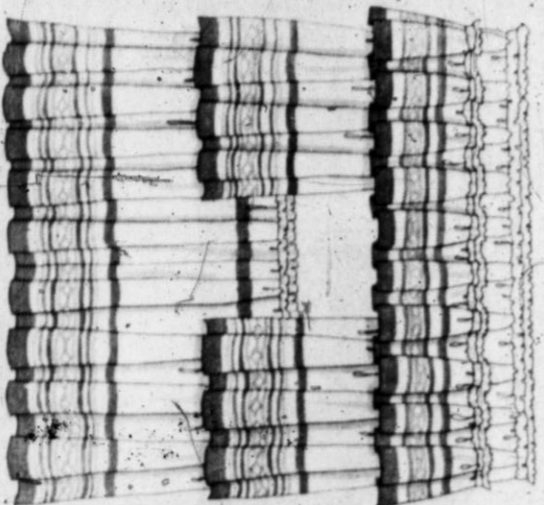

Sale 343

Reg. 4.29. 'Mayan' Osnaburg cotton weave with color coordinated trim. 68x36". Valance, reg. 2.79. **Sale 2.23**

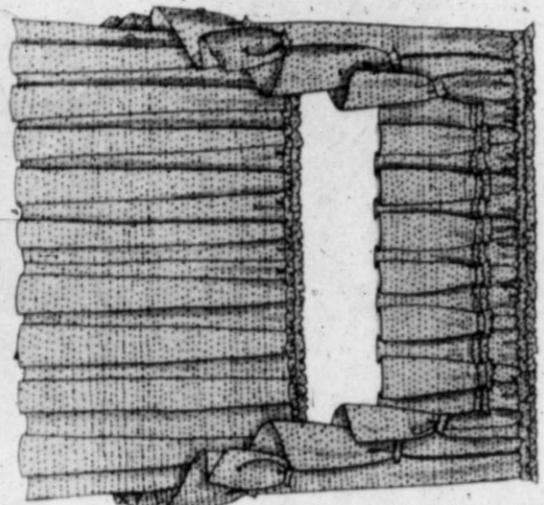

Sale 295

Reg. 3.69. 'Mercury 11' Dacron® polyester nylon. Flocked white dots on colors. 80x36". Swag topper, reg. 4.69. **Sale 3.75**

JCPenney

We know what you're looking for.

20% off these elegant 'Jewel-Tex' drapes.

Sale 1160 50x84" Reg. 14.50

Sale 2000 75x84" Reg. \$25

Sale 2640 100x84" Reg. \$33

Floor length drapes in the three most popular widths. 'Jewel-Tex' are a luxurious blend of dobby weave cotton/rayon. Penn-Prest so they machine wash, tumble dry, never need ironing. Thermal acrylic back insulates year round. Wide selection of decorator colors.
 Sale prices effective thru Saturday, Charge it. For something special, shop the JCPenney Catalog, available in most stores.

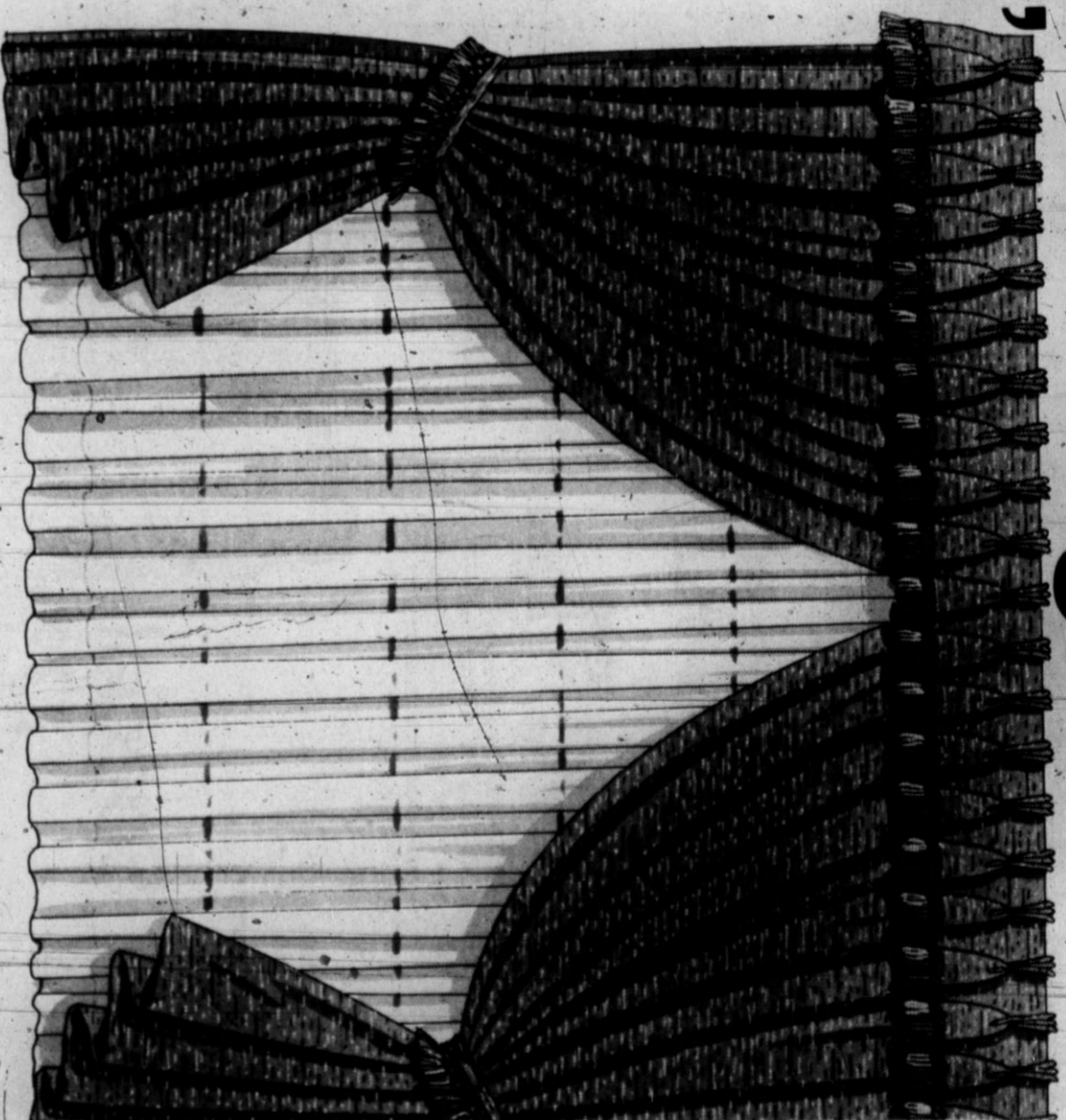

And 20% off bedspreads and rugs.

Sale 1680

Reg. \$21. 'Vallejo' full size bedspread in woven cotton jacquard patterns. Choose from rich colors.

Sale 1600

Reg. \$20. 'Royalty' full size spread. Crushed velvet look in flocced rayon/cotton. Vivid colors.

Sale 319 24x36"

Reg. 3.99. Nylon cut and loop pile with geometric border. Style 3521. Or Polyester plush pile in multi-colored stripes. Style 3571. 27x48". reg. 5.99. **Sale 4.79**

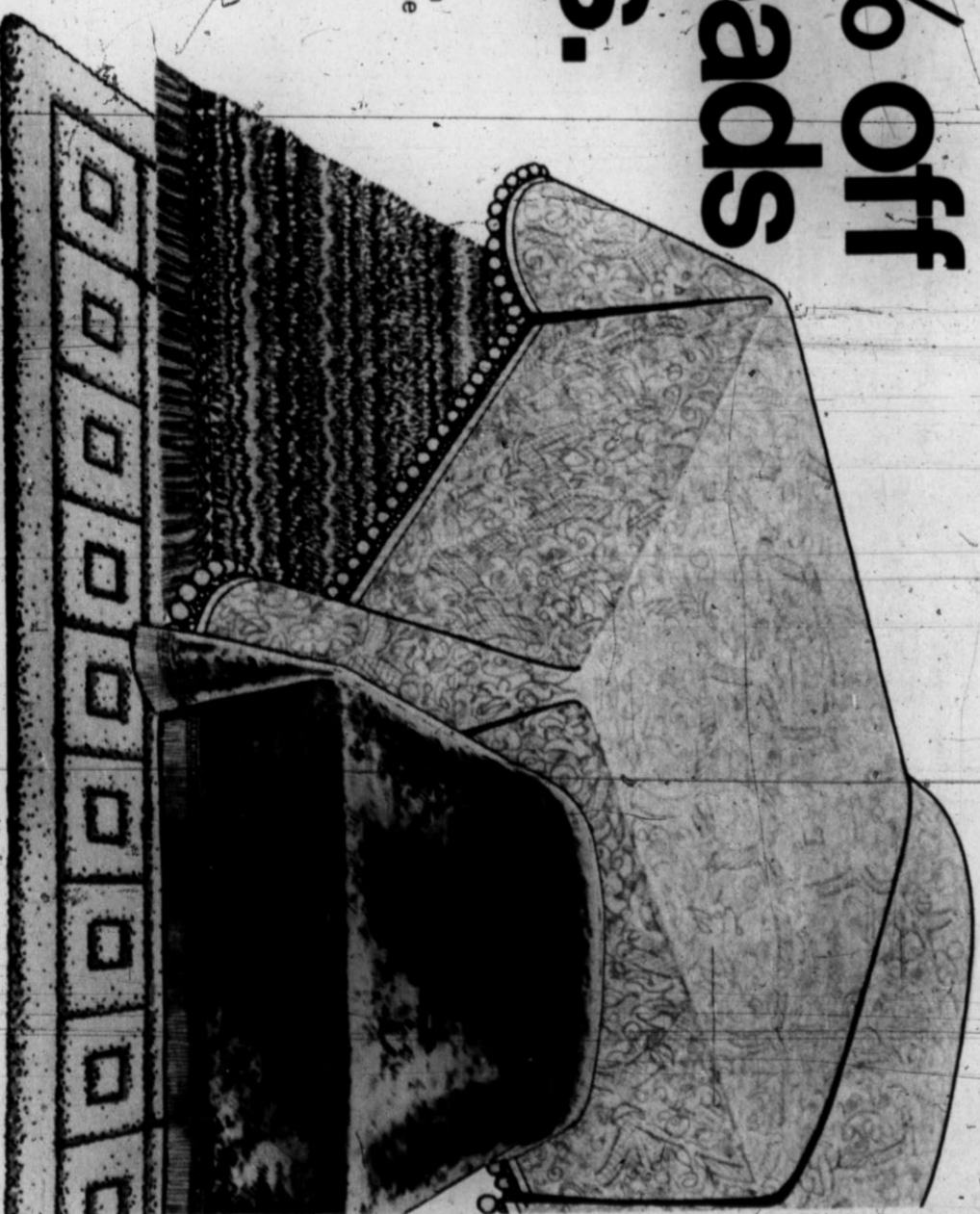

JCPenney

We know what you're looking for.

**Sale 20% off
on our entire line
of bras and girdles.
Shape up and save.**

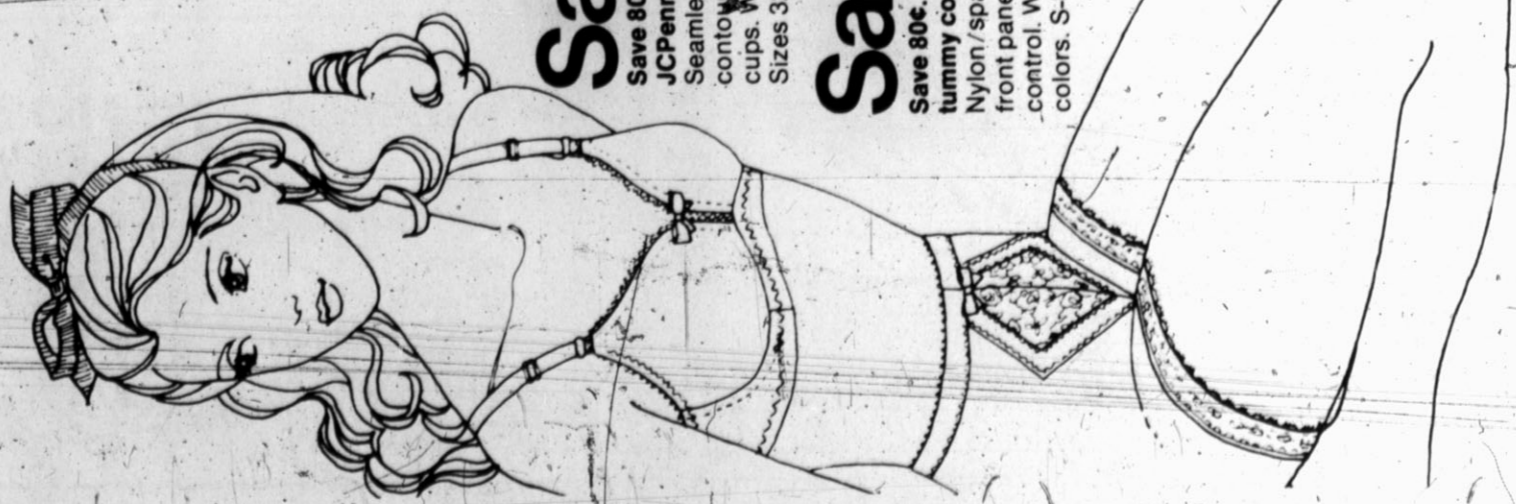

Sale 320

Save 80¢. Reg. \$4.
JCPenney bra.
Seamless styled
contour nylon tricot
cups. White and nude.
Sizes 32-36, A, B, C.

Sale 320

Save 80¢. Reg. \$4.
tummy controller brief.
Nylon/spandex with a
front panel for firm
control. White and
colors. S-M-L

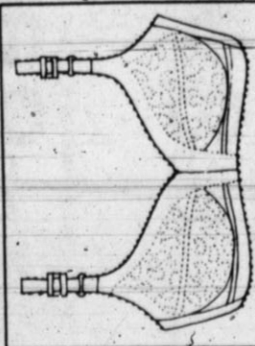

Sale \$4

Save \$1. Reg. \$5
Comfort Hours bra.
Nylon lace cups. 32-40, C.
Sale 4.80.
D cups reg. \$6.

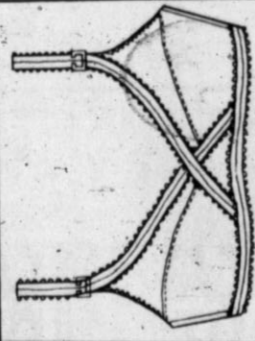

Sale 280

Save 70¢. Reg. 3.50.
cross-over nylon tricot
bra. Natural cup
comfort and fit. 32-40,
B, C, White.

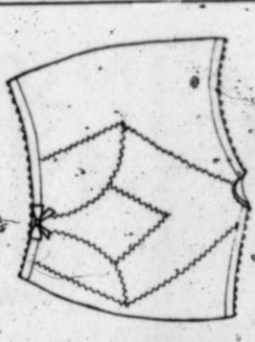

Sale 320

Save 80¢. Reg. \$4.
garterless brief.
Nylon/spandex with
lace underlay front
panel. Shaped seat.

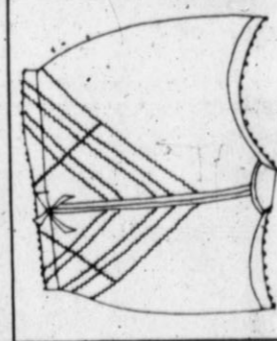

Sale \$4

Save \$1. Reg. \$5.
garterless brief. Front
V-band control.
Nylon/spandex. Sizes S-M-L.

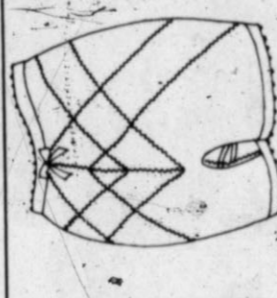

Sale 720

Save 1.80. Reg. \$9.
long leg panty girdle.
Nylon/acetate/spandex
with criss cross inner
bands.



Special 2 for 88¢

All sheer sandalfoot
pant hose. Super-fit, super
stretch proportioned sizes.
Suntan, coffee bean or gala.

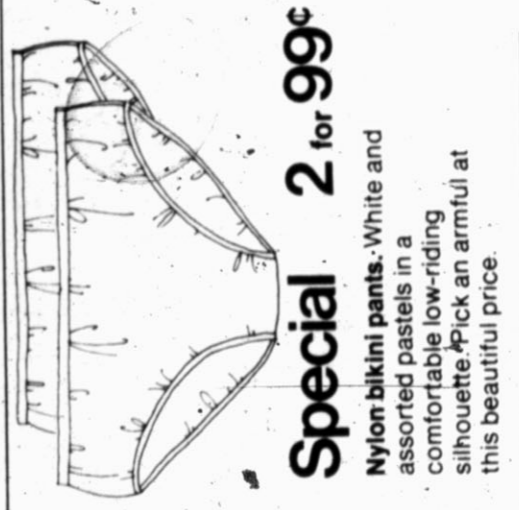

Special 2 for 99¢

Nylon bikini pants. White and
assorted pastels in a
comfortable low-riding
silhouette. Pick an armful at
this beautiful price.

Sale prices effective thru
Saturday only.
Charge it.

**Rest assured.
Our sales
and specials
for your bed
are great.**

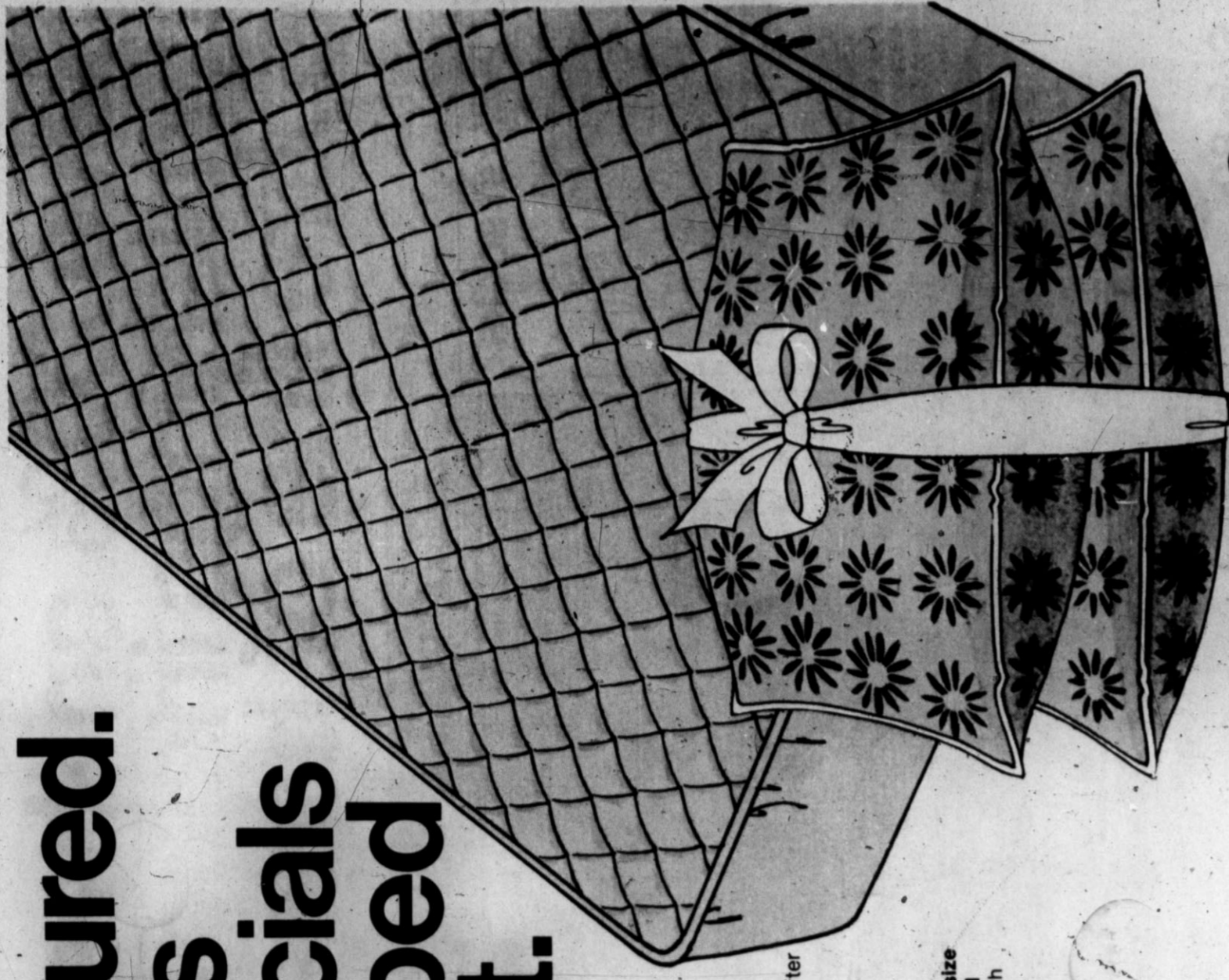

Sale 399

twin fitted

Save \$1. Reg. 4.99, quilted mattress pads.
Cotton cover with bonded polyester fill.
Protects your bed. Retains its whiteness after
many washings.
Full size, reg. 6.19, Sale 4.95.

Sale 2 for \$8

standard size
pillows. Completely washable polyester with
Penn-Prest® polyester/cotton ticking.
Sale 2 for 9.60. Queen size, reg. 2 for \$12.
Sale 2 for 12.80. King size, reg. 2 for \$16.

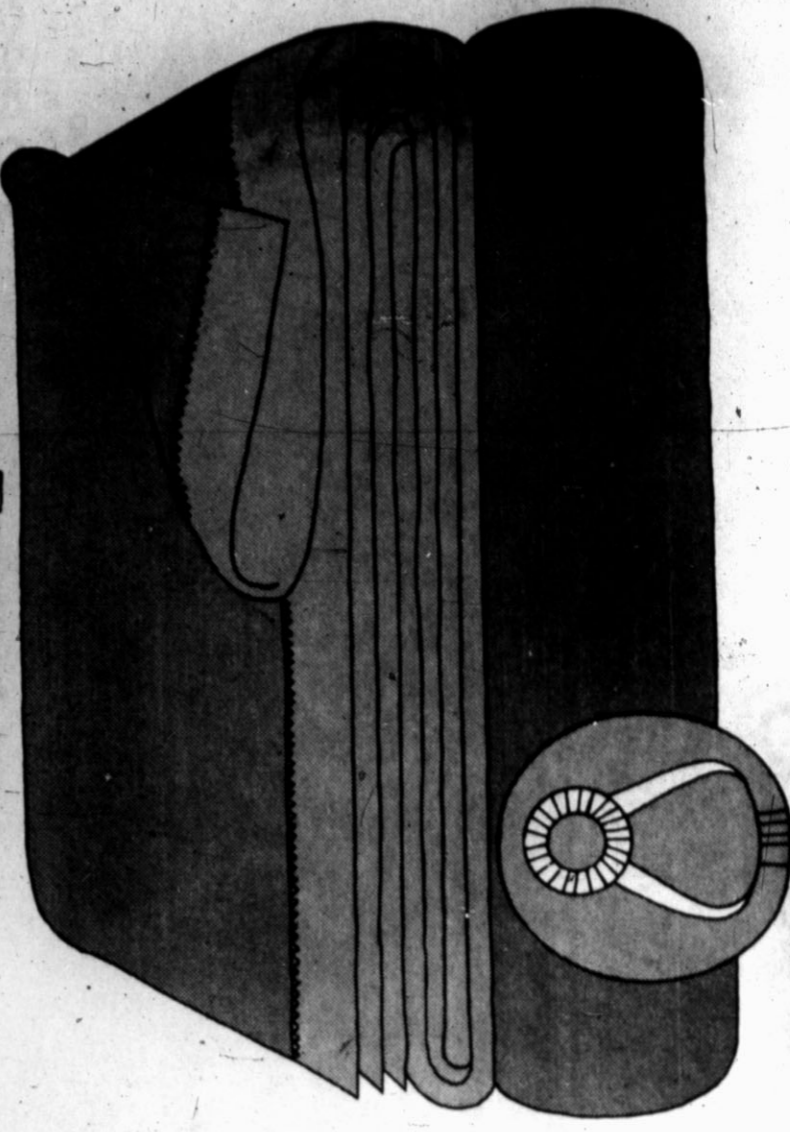

Special \$13.

full size
Beautiful electric blanket in a quality blend of
polyester/acrylic with single control heating
comfort. Choose from: goldenrod, avocado,
blue or pink.

Sale prices effective thru
Saturday only.
For all your bedding needs
see our JCPenneys Catalog.

Charge it.

JCPenney

We know what you're looking for.

JCPenney

We know what you're looking for.

Save 20% on these men's furnishings including our entire line of hosiery.

Sales and other buys for a great Spring wardrobe. Charge now and save.

20% off socks

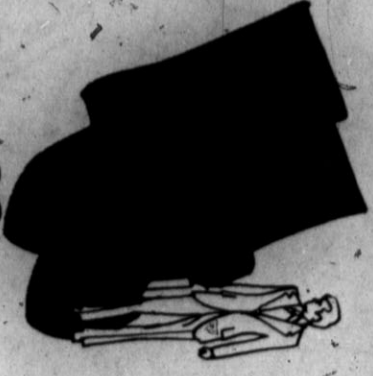

Sale 63¢ pr.

Save 16¢. Reg. 79¢. men's dress socks of stretch nylon. Assl. Colors.

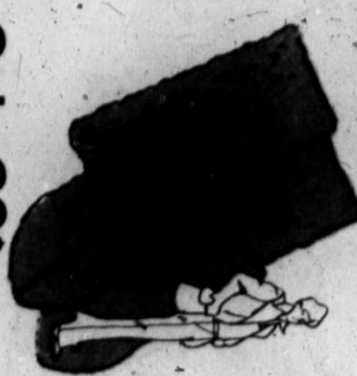

Sale 80¢ pr.

Save 20¢. Reg. \$1. casual socks in Orion® acrylic. One size fits all.

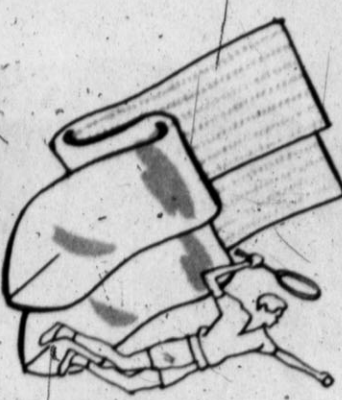

Sale 80¢ pr.

Save 20¢. Reg. \$1. sporty terry crew socks in acrylic/nylon stretch. Fashion colors.

20% off men's underwear.

Save 60¢. Reg. \$1.20. men's polyester/cotton briefs, athletic style and briefs. Cut for comfort and wear. Available in stripes or fl. While only in stock. Reg. \$1.20. Briefs, shirt sizes 36-48, and brief sizes 36-48. Buy them by the dozen for outstanding savings!

3 for 2⁰⁰

20% off sport shirts.

Sale \$4

Save \$1. Reg. \$5. men's sport shirts in a colorful assortment of polyester/cotton. Solids and fancies. 2 pockets. Short sleeves.

Sale prices effective thru Saturday only.

Charge it.

Special

2 for \$7

Women's polyester knit tops in short and long sleeve styling. Choose from a wide variety in great colors.

Sale prices effective thru Saturday.

Charge it. For hard to find sizes, shop the JCPenney Catalog, available in most stores.

Sale 80¢

Reg. \$10. Women's proportioned pants in machine washable polyester knit. Solids and fancies in sizes 8-20A, 10-20T.

Sale 88¢

Reg. \$11. Women's polyester doubleknit pants in bright solids. Cuffed or uncuffed styles. Misses sizes.

Special

2 for \$10

Women's polyester rib-knit solids with cuffs or assorted fancies in plain flare styling. Sizes 10-20.

JCPenney
We know what you're looking for.

JCPenney
We know what you're looking for.



B O A N S I E C U A D A U S S I

EXCEL

SAN KOTEX, REG. C

You'll Warm Up To These WINTER FOOD SPECIALS

Come to HEREFORD MEAT MARKET and Pick Up Your FREE CALENDAR... While they last...

TOMATOES
39¢ Lb. or 3 Lbs. \$1.00

Nice Fresh California

LETTUCE

29¢ or 4/\$1.00
Head

FREE
gallon Hereford Pure Milk Co..
BUTTERMILK

With \$5.00 Purchase or more

We have a complete Line of Hereford Pure Milk Co. Products—Come in and give them a try!

12 lb. Block or 10 lb. Crushed or Cubed
ICE 50¢

Assortment
HOSE

1/2 Price

Colorado Morgold 10 lb. Bag
POTATOES 99¢

Large Selection of

MOTOR OILS

Come in and check our Prices...



California **ORANGES** 29¢ lb. or 4/\$1.00

Texas Ruby Red 18 lb. Bag **GRAPEFRUIT** \$1.99



NUTS 69¢ lb.
All varieties
Almonds-Pecans-Walnuts-Brazil Nuts
Chestnuts-Filberts

HEREFORD MEAT MARKET INC.

At the Sign of the WHITEFACE BULL

HWY 385N. OPEN DAILY 8:00 A.M. to 8:00 P.M.

Weekly Television Magazine

The Hereford Brand

Thursday, Jan. 3, 1974

Tel-Aire



Winter Fun - Hereford Cablevision

- Three Independent Stations
- Static-Free Reception
- Three Major Networks
- 8 Big Stations
- Public Broadcasting Service
- 24 Hour Weather and FM Music
- \$10⁰⁰ Installation Charge
- \$5⁰⁰ Per/Mo. Service Charge

126 E. 3rd **HEREFORD CABLEVISION** 364-3912

You Get It All On Cable

P.K. AUTO SUPPLY
HEREFORD
 364-4441
 801 W. 1st



12 VOLT BATTERIES
 Reg. \$26.95
 \$5.245 or 24¢
\$16.96
 P.K.'s Low Price
 W/Trade

30 MONTHS GUARANTEE
 LEAD ACID
 LEE OR ASTRO BRAND

SATURDAY
 ALL PROGRAMS SUBJECT TO CHANGE

CHANNEL	4	5	7	10	11	13	17	19	21	23	25	27	29	31
CABLE	KQHC	NBC	KVII	KXII	KXIX	KXII	KXIX	KXII	KXIX	KXII	KXIX	KXII	KXIX	KXII
1	10:00	10:00	10:00	10:00	10:00	10:00	10:00	10:00	10:00	10:00	10:00	10:00	10:00	10:00
2	10:00	10:00	10:00	10:00	10:00	10:00	10:00	10:00	10:00	10:00	10:00	10:00	10:00	10:00
3	10:00	10:00	10:00	10:00	10:00	10:00	10:00	10:00	10:00	10:00	10:00	10:00	10:00	10:00
4	10:00	10:00	10:00	10:00	10:00	10:00	10:00	10:00	10:00	10:00	10:00	10:00	10:00	10:00
5	10:00	10:00	10:00	10:00	10:00	10:00	10:00	10:00	10:00	10:00	10:00	10:00	10:00	10:00
6	10:00	10:00	10:00	10:00	10:00	10:00	10:00	10:00	10:00	10:00	10:00	10:00	10:00	10:00
7	10:00	10:00	10:00	10:00	10:00	10:00	10:00	10:00	10:00	10:00	10:00	10:00	10:00	10:00
8	10:00	10:00	10:00	10:00	10:00	10:00	10:00	10:00	10:00	10:00	10:00	10:00	10:00	10:00
9	10:00	10:00	10:00	10:00	10:00	10:00	10:00	10:00	10:00	10:00	10:00	10:00	10:00	10:00
10	10:00	10:00	10:00	10:00	10:00	10:00	10:00	10:00	10:00	10:00	10:00	10:00	10:00	10:00
11	10:00	10:00	10:00	10:00	10:00	10:00	10:00	10:00	10:00	10:00	10:00	10:00	10:00	10:00
12	10:00	10:00	10:00	10:00	10:00	10:00	10:00	10:00	10:00	10:00	10:00	10:00	10:00	10:00

SHOOK TIRE CO.
 May We Serve You



WHERE TO BUY THEM!
 600 W. 1st
 364-1010

KLEINER'S JEWELRY

Taylor Furniture & Appliance Center
 Authorized
 GENERAL ELECTRIC APPLIANCES Sales & Service
 603 Park Ave. 364-1561

Boot & Saddle Western Wear
 Western Wear for the Whole Family!
 513 N. 25 Mile Avenue
 364-5332

Clark's "HOUSE OF FLOWERS"
 900 Lee Phone 806-364-0306
 Hereford, Texas 79045

VIBRO-STEAM
 20% Off on Carpet Cleaning
 Fall Special
 CLARK'S
 Carpet Cleaning
 Commercial - Residential
 133 Ave. J Phone 364-4151

Quasar II 23" CONSOLE COLOR TV
 W/Trade \$569.00
 Sanyo Knox TV & Music
 509 Park Ave. 364-0766

Saturday Program Notes

11:00...ABC...THE ABC SATURDAY SUPERSTAR MOVIE—"LOST IN SPACE" II, a space shuttle commanded by Craig Robinson, is shot down on a strange planet, where the passengers are metallic creatures making war on the peaceful Progs, the original inhabitants. (8)

11:30...NBC...GO "GO" HAS the Grand National Drag Races in Sonair, Quebec. Radio personality Don Imus hosts. (R) 12:00...ABC...AMERICAN BAND. The guests will be Ann Peleles and El Chicago.

3:00...ABC...ABC'S WIDE WORLD OF SPORTS will telecast live coverage of the Hula Bowl, from Honolulu Stadium in Honolulu. Hosted by the 1973 season divided into two squads, East and West. The commentators will be Keith Jackson and O. J. Simpson.

3:30...CBS...RED CROWN CLASSIC The finals of the \$85,000 women's professional bowling tournament will be broadcast from Brunswick Perry X. Other features of this special broadcast, a field of 192 top pros will be narrowed down, with the top five moving into the televised finals.

4:00...ABC...BING CROSBY NATIONAL PROGRAM CBS' exclusive live telecast of the final round of play in this golf tournament from Pebble Beach, California. Commentators will be provided by Chris Schenkel, Jim McKay, Bill Flemming and color commentator by Bing Crosby, Byron Nelson and Dave Marr.

7:00...NBC...EMERGENCY! "Emergency!" A rising life 1980 pay attempt to rescue a fireman caught beneath a tractor.

7:00...ABC...ABC NEWS CLOSEUP ON: THE RIGHT TO DIE An ABC News special which will explore an intensely personal subject that no one wants to talk about and examines the disturbing ethical and moral questions that surround the issue of death. "When should death come? And who should decide?" ABC News will go to hospitals where patients, children as well as the elderly, courageously talk about their attitude toward death with their physicians. The special also features a report on the latest advances in life support technology offered by medical science to preserve life. Stephen Greer is the ABC News correspondent for the special.

7:00...ABC...THE PARTIRIDGE FAMILY "The Partiridge Family" with guest stars, David Williams, Andy and David. Reuben's new clients, who are 14-year-old identical twins, develop an identical crush on Laurie Partiridge.

7:30...CBS...MASH Lt. Col. Henry Blake discovers the fountain of youth while visiting and recuperating in Tokyo and returns to report that he has discovered love.

8:00...NBC...NBC SATURDAY NIGHT AT THE MOVIES—"SILENT RUNNING" "Silent Running" is an original story by Douglas Trumbull, the drama deals with man's relationship with machines, nature and himself in the face of total isolation. Universal. TV-14. (R) 8:00...ABC...THE NIGHT WEST

Sunday Program Notes

10:30...ABC...MAKE A WISH "Make a Wish" is a heartwarming story written by his brother Harry Chanin. Today's topics are "Cloud" and "Arrow."

1:00...NBC...NATIONAL HOCKEY LEAGUE GAME Detroit Red Wings, St. Louis Blues, one of the best games of the season between periods. The announcing team is comprised of Ted Lindsay, Brian MacFarland and Tim Ryan.

1:30...CBS...NBA TODAY National Basketball Association game Phoenix Suns vs. Chicago Bulls. Pat Summerall will provide the play by play. Eight Baylor will provide the half-time and post-game segments. (From the Chicago Stadium, Chicago, Ill.)

1:30...ABC...HOWARD COSELL AT LARGE—WHAT IS HE REALLY LIKE? ABC Sports special which takes a look at the life of Howard Cosell. There will be a look at his emergence as a sportsman and sportswriter with a review of his early days as a sportscaster in Yankee Stadium. Other features of this special will be Howard Cosell at home with his wife, children and grandchildren. The special also features a look at his relationship with Muhammad Ali and a review of his political aspirations.

2:30...ABC...ABC'S WIDE WORLD OF SPORTS The Harlem Globetrotters from Wembley Stadium in London, England will play by play by Will Chamberlain plus other events to be announced.

4:00...ABC...BING CROSBY NATIONAL PROGRAM CBS' exclusive live telecast of the final round of play in this golf tournament from Pebble Beach, California. Commentators will be provided by Chris Schenkel, Jim McKay, Bill Flemming and color commentator by Bing Crosby, Byron Nelson and Dave Marr.

4:00...NBC...A CONVERSATION WITH PROFESSOR RAYMOND ARON The distinguished scholar of world affairs talks with NBC News correspondent Edwin Newman.

4:30...NBC...THE WONDERFUL WORLD OF DISNEY The first half of "The Walt Kid and the Mystery of Riverton, starring Eric Robison, Clay O'Brien and the other members of the cast. The film is a local government official. The conclusion will be telecast Sunday, Jan. 13, 9:00pm-9:30pm.

4:30...CBS...THE NEW PERRY MASON The case of the Telltale Trunk, a millionaire, dead more than four years, turns up in Hong Kong. Mason is called upon to defend the man who admits planning the murder, as a murder loke. As Mason attempts to unravel the mystery, he hears that others were present on the night the man was murdered. Mason admits to the mistress and a man who admits to participating in the murder planned by the accused. (8)

7:30...CBS...THE MYSTERY DOUBLE FEATURE: MANNIX-BARNABY JONES (7:30-8:30 p.m.). "Race Against Time" Private eye Joe Mannix tries to save a freedom fighter who is in hiding and dying in a nation ruled by a ruthless military dictator. Mannix's task is to smuggle a heart pacemaker into the country to implant a "venous" in the dictator's chest. "A well-known woman's lib leader and an equally famous male chauvinist writer carry on a public feud and a private love affair."

MEXICAN FOODS
 Little's El Toro Restaurant
 CLOSED MONDAYS
 364-9618
 E. Hwy 60

PLAINS
 For All Your Insurance Needs
 Open! 8 a.m. - 5:30 p.m.
 218 W. 3rd
 364-2232

\$85,000 Red Crown Classic

The finals of the \$85,000 Red Crown Classic, the richest tournament in the history of women's professional bowling, will be held at Brunswick Perry Hall Lanes, Baltimore, Md., Jan. 5 (3:30-5:00 p.m.). This will mark the first time that a Professional Women's Bowling Association (PWBA) tournament has been broadcast on network television.

A field of 192 top women pros will compete in the five-day event, which carries a winner's prize of \$12,500. The field will include Judy Cook, currently the highest bowler on the PWBA tour; Patti Costello, current Bagley of the Year; Dottie Fothergill, all-time leading money winner; Paula Saeffer, 1971 Bowler of the Year; and Yvonne Grindfield, rising young star from California. Miss Cook recently set two PWBA records.

CHANNEL	4	5	7	10	11	13	17	19	21	23	25	27	29	31
CABLE	KQHC	NBC	KVII	KXII	KXIX	KXII	KXIX	KXII	KXIX	KXII	KXIX	KXII	KXIX	KXII
1	10:00	10:00	10:00	10:00	10:00	10:00	10:00	10:00	10:00	10:00	10:00	10:00	10:00	10:00
2	10:00	10:00	10:00	10:00	10:00	10:00	10:00	10:00	10:00	10:00	10:00	10:00	10:00	10:00
3	10:00	10:00	10:00	10:00	10:00	10:00	10:00	10:00	10:00	10:00	10:00	10:00	10:00	10:00
4	10:00	10:00	10:00	10:00	10:00	10:00	10:00	10:00	10:00	10:00	10:00	10:00	10:00	10:00
5	10:00	10:00	10:00	10:00	10:00	10:00	10:00	10:00	10:00	10:00	10:00	10:00	10:00	10:00
6	10:00	10:00	10:00	10:00	10:00	10:00	10:00	10:00	10:00	10:00	10:00	10:00	10:00	10:00
7	10:00	10:00	10:00	10:00	10:00	10:00	10:00	10:00	10:00	10:00	10:00	10:00	10:00	10:00
8	10:00	10:00	10:00	10:00	10:00	10:00	10:00	10:00	10:00	10:00	10:00	10:00	10:00	10:00
9	10:00	10:00	10:00	10:00	10:00	10:00	10:00	10:00	10:00	10:00	10:00	10:00	10:00	10:00
10	10:00	10:00	10:00	10:00	10:00	10:00	10:00	10:00	10:00	10:00	10:00	10:00	10:00	10:00
11	10:00	10:00	10:00	10:00	10:00	10:00	10:00	10:00	10:00	10:00	10:00	10:00	10:00	10:00
12	10:00	10:00	10:00	10:00	10:00	10:00	10:00	10:00	10:00	10:00	10:00	10:00	10:00	10:00