

THE MUNDAY COURIER

Serving The Best Informed Readers In Knox County

(ISSN 8750-6730)

VOLUME 16

THURSDAY, JUNE 18, 1987

MUNDAY, TEXAS 76371

PRICE 35¢

10 PAGES IN ONE SECTION

NO. 38



RALPH CYPERT, right, shows off a four pound, 15 ounce black bass he caught in Miller Creek Reservoir Sunday during the Munday Chamber of Commerce bass tournament. For a while it looked as though Cypert might win the tourney, but he had to settle for runner-up honors when Morris Stephens of Abilene weighed in a five-pound fish for the championship. He took a purse of \$655, and Cypert won \$325. With the local fisherman is Bobby D. Burnett, one of the tournament's committee members.

ABILENE FISHERMAN WINS

Bass Tournament Is Proclaimed Success

Munday Chamber of Commerce manager Kay Looney and Jo Heard, chairman for the first Chamber bass tournament, must have been living right last week, because the unpredictable weather settled to almost perfection for the Sunday tourney. Morris Stephens of Abilene, a member of the Big Country Bass Club, left Miller Creek Reservoir with a top prize of \$655 in cash Sunday after bringing in the largest bass. The winner weighed in at an even five pounds.

Second place went to Ralph Cypert with his 4 pound, 15 ounce entry. He took home \$325 of the purse. Sandy Gilly of Aspermont, third place winner with a 4 pound, 3 1/2 ounce bass, won \$200, and Roy Booth of Wichita Falls earned \$130 with a fourth place 4 pound, 2 1/2 ounce catch. Seventy-five persons registered for the tournament.

Other prize winners, in order, were Will Johnson of Cisco, Lee Buchanan of Abilene, Kenneth Groves of Munday, Eugene Guthrie of Seymour, Larry Welch of Munday, Larry Knutson of Pampa, Rodney Hons of Seymour, Butch Willingham of Cisco, Gary Cypert of Munday, J.L. Stracener of Abilene, Mark Decker of Lubbock, Cotton Harvey of Stamford, Mike Jurecek of Seymour, Gwen Decker of Lubbock, Allen Bates of Abilene, Gary Vita of Seymour, Helen Vestal of Electra, Keith Conner of Benjamin, Wesley Penner of Seymour and Judge Ward of Aspermont.

"Overall, I'd say we had a very successful first-time tournament," Mrs. Looney said. "We had some rough spots that we hadn't foreseen, but the fishermen seemed happy. And I was thrilled at the number of people who came to just watch."

"And some of them had never fished before," added Ralph Cypert. "The out-of-town people enjoyed fishing here. I think it went off real well and it will be even bigger next year."

The amount of cash given as prize money was large for a first-time tournament, Mrs. Looney said, and she received many comments on how well the tournament was organized.

Chamber directors are satisfied, too, with the profit made from the tournament. They have already voted to make it an annual affair and have agreed to sponsor a two-day tourney next year.

"The weather was perfect, the skiers even stayed off the lake until we were finished, and we had lots of local entries and others from as far away as Pampa," Mrs. Looney continued. "All in all, I don't see how we could have done much better."

The fish caught ranged from the five pounder down to some that were almost too small to be weighed. The smallest prize-winner weighed about a pound and a half.

In an ad located elsewhere in the *Courier*, the Chamber expresses thanks to those persons who worked so hard to make the tournament a success.

Lions, Wives Enjoy Ladies Night Supper

Members of the Munday Lions Club feted their wives with a hamburger supper Tuesday evening, June 9, at the home of Gary and Paula Schur. Thirty-four persons enjoyed a delicious meal of grilled hamburgers, potato salad, baked beans and all the homemade ice cream they could eat.

The fun and games that took place after the meal included an "old" couples' newlywed game for some local husbands and wives who are not exactly newlyweds. Lucky participants in the game were the Richie Smiths, E.B. Littlefields, Bob Browns and William Stewarts. For any additional comments on the games, queries may be directed to Mary Smith, Orbyrie Littlefield, Allene Brown and Elsie Stewart, who found out just how much their husbands had learned in twenty-plus years of marriage!

The group expressed thanks to the Schurs for the supper and for their hospitality.

Ranch Day Planned By Knox County Historians

July 18 will be a special day for members of the Knox County Historical Commission, as they join a county-wide Ranch Day celebration at the Benjamin Memorial Building. Proceeds from this fund-raiser will help finance the formation of a Knox County Museum.

Activities planned for the special day include arena events in the morning, various games, a craft show for local artists, a display of historical items and quilts and a pioneer and ranch reunion. Also on display will be brands used in the county, and ranchers are urged to bring branding irons to this event so many of the local brands will be represented. Donations of lumber for the display will also be appreciated.

A tour of early day homes in Benjamin is also planned. Homes will include some of those built around the time Knox County was organized. A barbecue meal will be catered by county women in the evening. Donations of meat and paper products, etc., are needed for the supper, and those interested in helping can contact Pearl Ryder at Benjamin. Concession stands will also be set up during the day's events.



MUNDAY BLOOD DONORS were recognized for surpassing the set goal of the past fiscal year at the annual meeting of the area Red Cross Blood Services held recently in Wichita Falls. Mrs. Latrece Lane, right, coordinator for the Red Cross bloodmobile visits in Munday, received a plaque which will hang at the Munday Community Center, where bloodmobile donations are taken. At left is Jeanie Carden, administrator of the Community Center.

Munday Honored By Area Red Cross Blood Service

The city of Munday was one of three regional blood services honored at the 70th annual meeting of the Wichita County and Red River Regional Blood Services held Friday night at the Sheraton Hotel in Wichita Falls.

Jackie David of Dallas was keynote speaker, following a theme of "70 Years of Service to People Through People." Mrs. David, a Red Cross volunteer for 19 years, served as national chairman of volunteers from 1982 to 1985 and is a member of the National Board of Governors.

She remarked, "Volunteers are the greatest renewable resource of our community, and they are needed more than ever for blood services."

Special recognition was given to all regional volunteers, several of whom received awards. The town of Munday was honored for having attained 102 percent of its blood donation goal for the past fiscal year. The blood mobile comes to Munday twice a year, with a goal of 60 pints of blood for each trip.

Mrs. Latrece Lane, chairman of the bloodmobile visits in Munday, was at the banquet to receive a plaque proclaiming Munday outstanding for its contribution to the Red Cross. Mrs. Lane said the

honor belongs to all our area volunteers.

"The planning of a mobile visit, the donors, the many workers, all comprise a successful team for these Red Cross visits," she said. "Each one who has a part in the bloodmobile, in any capacity, can feel proud of the plaque and the honor that has been bestowed upon our town."

School Board To Appoint New Trustee

A replacement on the Munday High School teaching staff has created a vacancy on the school district's board of directors, and trustees are seeking persons interested in filling the empty spot on the board.

Bob Winchester, a longtime science teacher at the school and a trustee since 1984, will return to the classroom next fall to replace Bill Kingston, who will serve as secondary school principal. Winchester had resigned from teaching several years ago due to health reasons but has stayed in close contact with the school's operation by serving on the board of trustees.

The remaining trustees will appoint someone to fill the vacancy created by Winchester's resignation, according to school superintendent Doyle Lowrance. Qualified individuals interested in being considered for this appointment need to contact Lowrance at the superintendent's office in person.

The appointment will be effective until the next election in the spring of 1988, and names of those who wish to serve the remaining two years of the term will be placed on the ballot at that time.

Deadline for filing for consideration to the appointment is Thursday, July 2, Lowrance said.

Weather Report

For seven days ending Monday, June 15, 1987, as compiled and recorded by Goodson Sellers, local U.S. weather observer.

	TEMPERATURE	
	HIGH	LOW
June 9	76	67
June 10	85	68
June 11	85	68
June 12	90	69
June 13	93	67
June 14	97	67
June 15	99	70

Rainfall this week - .23
Rainfall year to date - 17.07

Average Potatoes Dug As Munday Harvest Begins

Potato harvest in the Munday area started Sunday, and what had at first looked to be an excellent crop has been downgraded to average in most spots. The late freeze and excessive rainfall are targeted as the culprits for a low yield in chip potatoes.

The quality of area red potatoes is good, one spokesman said. The color, one of the factors looked at in determining quality, is good, but the skin is not set as well as producers would like. More sunshine and drying weather would be required for this particular quality to improve.

The red potatoes are good sized, and the market demand is moderate to strong with a fair price, according to a producer. The yield will range from low to average in this variety.

Yields of chipper potatoes is down considerably in many fields because of the inclement weather. These potatoes just didn't get enough sunlight. The demand for chipping potatoes is strong and the

price is good, and an authority said the availability of this type of potato usually determines the price, so this indicates an overall low yield.

Harvest is expected to continue for another three or four weeks if the weather remains cooperative, and producers will wait until all the crop is out and sold either to contractors or on the open market before assessing the final results.

Local Vegetables To Be Judged At June 27 Show

Gardeners who think their vegetables are among the best in the area should enter them in the Knox County Vegetable Show to be held Saturday, June 27, at the Munday Community Center. Entries will be accepted between 8 and 9 a.m. at the show site.

Rules on entering the vegetable show are available at the Knox County Extension office in Benjamin, Farm and Garden Supply in Knox City and the Texas A&M University Vegetable Research Station in Munday. Included in the rules is the amount of each vegetable required to make an entry.

Virgil Woodfin of Iowa Park will judge the vegetables in three divisions: junior, 19 years and younger; senior, 20 years and older; and commercial. A champion vegetable will be selected from each division, and awards will be presented to the best

overall junior and senior home gardeners.

Organizers of the vegetable show are members of the Knox County Horticulture Committee chaired by David Bordovsky. Other members are Jim Dillon, Oscar Mangis, Lloyd Don and Jacquita Welch, Linda Jackson, Paul Richwine and Dwayne Johnson.

Sponsors for the show are the Whittle and Paint Shop, Dillon Greenhouse and Tri-State Chemical, Knox City; First National Bank and Osbornes, Munday; and Zeissel Brothers Fertilizer and Seed, Rhineland.

A farmers market will be held on the Community Center parking lot during the vegetable show. Spaces are available at \$5 each for producers and home gardeners who wish to sell their vegetables to the public. For information contact Paul Richwine.



MAYBE IT'LL GROW! What must have been the smallest fish at Miller Creek Sunday is filmed here by Ray Ford with his camcorder. Maxine Wilde holds the fish in a water glass as onlookers asked if this was the best she could do for a bass tournament entry. Reports were that it took both Mrs. Wilde and Earlene Kuehler to haul the monster in.

Steer Validation Scheduled June 24

Show steer validation for Knox County is set for 8:30 a.m. Wednesday, June 24, at the Beavers Mulky Ranch north of Benjamin. Validation cost this year is \$3.50 per head, and all 4-H and FFA members who plan to show a steer in any livestock show other than the county show must have the animal validated in order to be eligible for the show.

Each steer validated will receive a Texas Validation Tag which cannot be removed. Two nose prints and two pictures will also be taken of each steer. These will serve as permanent records of identification for the calf and can be checked at any livestock show.

Additional information is available at the Knox County Extension Service office at 454-2651.

Pest Identification Workshop Planned

The crops committee of the Knox County Extension Program Council has scheduled a crop pest identification and control workshop for 8 a.m. Tuesday, June 23, at the Texas A&M University Research Station in Munday.

Extension Service entomologist Emory Boring will introduce a slide presentation on cotton, sorghum and some vegetable pests. The group will then move to the field for some hands-on identification.



DENNIS EUGIN

Locals' Grandson Is Recent Graduate

Dennis Michael Eugin III, 18-year-old son of Mr. and Mrs. Michael R. Eugin, is a recent graduate of Frontier Regional High School in South Deerfield, Massachusetts. He is the grandson of Mr. and Mrs. Blaz Sosa of Munday, and Mrs. Sosa, her daughter, Martha, and her granddaughter, Michelle Sosa, all attended the graduation ceremony on June 5.

He is active in football, baseball, racketball and wrestling, in which he won several trophies. He represented his school in a chess tournament with other Pioneer Valley schools and won two first place awards.

Dennis will be stationed in Jackson, South Carolina for basic National Guard training this summer, and will continue his education in the fall at North Eastern University in Boston, where he will be a pre-law student.

Weekend Retreat Held At Rhineland

The senior youth group at St. Joseph's Catholic Church in Rhineland hosted a retreat on June 13 and 14 at the Columbus Club Hall. Susan Marrinan, Fort Worth Diocesan youth director, was in charge of the retreat, which was themed "You Make a Difference."

Randy W. Griffin, a seminarian working in the diocesan youth office for the summer, assisted in directing the retreat and provided vocal and guitar music. He and the youths were responsible for readings and music at the Saturday evening Mass.

The 44 young people attending came from Santa Rosa Parish in Knox City, Holy Family in Vernon, St. Mary's in Quanah, St. Patricio in Throckmorton and St. Joseph's.

Longtime Munday Resident Is Buried

Elsie Edwards Eiland, 97, a member of one of Munday's best known pioneer families, died Sunday, June 14, in Medical Arts Hospital in Lamesa. Funeral services were at 2:30 p.m. Tuesday, June 16, at the First United Methodist Church in Munday with Rev. Rex Mauldin of Lubbock, a former Munday pastor, officiating. Burial was in Johnson Cemetery under the direction of McCauley-Smith Funeral Home of Munday.

Mrs. Eiland was born September 16, 1889, in Elm, Missouri and married G.R. 'Dolph' Eiland June 9, 1915, in Paonia, Colorado. The couple moved to Munday in 1918, where Eiland was a partner in Eiland's Drug Store and Jones and Eiland insurance and real estate in addition to having farming interests. He died in March, 1946.

A 68-year member of the First United Methodist Church in Munday, Mrs. Eiland taught a young couples Sunday school class for many years and was involved in the Methodist Women's Missionary Group and the Munday Study Club. She moved from Munday to Lamesa in 1983. Also preceding her in death were a daughter, Beth Louise Eiland, and two sons, David Clarence Eiland and George Randolph Eiland, Jr.

Survivors include two daughters, Barbara Walker and Maxine Grammer, both of Lamesa; a daughter-in-law, Mrs. George (Velma) Eiland of Lamesa; ten grandchildren, 21 great-grandchildren and six great-great-grandchildren.

Sales Tax Rebates

June tax rebate checks released by Comptroller Bob Bullock are down about 6 percent from the payments made last June. The checks represent taxes collected on sales made in April in cities that levy a one percent city tax.

Munday's check was for \$2,327.22, a small amount larger than the rebate at this time last year. Knox City's June payment was also slightly increased at \$4,589.01. But both towns show an overall decrease in 1986 payments, Munday's drop the smallest at 11.32 percent, from \$23,564.91 at this point in 1986 to \$20,896.21 now. Knox City has received \$22,677.18 in 1987, compared to \$41,018.37 last year for a decrease of 17.90 percent.

Goree received a check for \$595 in June, bringing that community's 1987 total to \$3,401.39, down 20.45 percent from last year.

Munday Councilmen Approve Ordinance

The City Council of the City of Munday, Texas met in regular session Tuesday, June 9, at the Munday City Hall.

Members present were Mayor Doris Dickerson and Aldermen Jessie Tucker, Gene Brown, Jessie Andrade and Garon Tidwell. Richard Albus was absent.

Mayor Dickerson called the meeting to order. A recording of the May budget hearing May 12 regular meeting and May 18 special session was read. Brown moved the budget hearing as recorded and minutes as written be approved. Andrade seconded. All members voted for.

First business was presented by Leon Sellers of West Texas Utilities Company. Sellers read instruments which reflected a request of WTU Co. for a 23.9% rate increase. He cited the OklaUnion coal fired plant as principal reason for the requested increase. Amounts were given for various kilowatt hours used by residents or business customers and dollar amount of increase. After discussion, Brown moved the proposed rate increase be delayed from the projected effective date of June 23, 1987 to September 21, 1987, in order that the City may have time to adequately review such proposed rate increase; also that Don Butler be hired as attorney to represent Munday (he also will represent Abilene and at least 11 other cities) to work with rate consultants, Diversified Utility Consultant, Inc., to fully study the rate request to determine whether or not the amount requested, which is substantial, is justified; also that Walter Hertel is appointed as contact person to relay all correspondence and phone calls related to the rate request. Andrade seconded the motion. Voting for the motion were Brown, Andrade, Tucker and Tidwell. Motion carried.

Next considered was passage of an ordinance authorizing the issuance of Certificates of Obligation. The proposed ordinance was read. Brown moved that the proposed ordinance be passed and the mayor be authorized to sign said ordinance. City Secretary to attest same. Tidwell seconded. Voting for were Brown, Tidwell, Tucker and Andrade. Motion carried.

CERTIFICATE FOR ORDINANCE

We, the undersigned officers of said City, hereby certify as follows:

1. The City Council of said City convened in regular meeting on the 9 day of June, 1987, at the City Hall, and the roll was called of the duly constituted officers and members of said City Council, to-wit: Doris Dickerson, Mayor, W.M. Hertel, City Secretary, Jessie Andrade, Richard Albus, Garon Tidwell, Gene Brown, Jessie Tucker and all of said persons were present, except the following absentees: Richard Albus, thus constituting a quorum. Whereupon, among other business, the following was transacted at said meeting: a written ORDINANCE AUTHORIZING THE ISSUANCE OF CERTIFICATES OF OBLIGATION was duly introduced for the con-

sideration of said City Council and read in full. It was then duly moved and seconded that said Ordinance be adopted; and, after due discussion, said motion carrying with it the adoption of said ordinance, prevailed and carried by the following voted:

Ayes - all members of said City Council shown present above voted "Aye".

Noes - none.

2. That a true, full and correct copy of the aforesaid ordinance adopted at the meeting described in the above and foregoing paragraph is attached to and follows this certificate; that said ordinance has been duly recorded in said City Council's minutes of said meeting; that the above and foregoing paragraph is a true, full and correct excerpt from said City Council's minutes of said meeting pertaining to the adoption of said ordinance; that the persons named in the above and foregoing paragraph are the duly chosen, qualified and acting officers and members of said City Council as indicated therein; that each of the officers and members of said City Council was duly and sufficiently notified officially and personally, in advance, of the time, place and purpose of the aforesaid meeting, and that said ordinance would be introduced and considered for adoption at said meeting, and each of said officers and members consented, in advance, to the holding of said meeting for such purpose, and that said meeting was open to the public and public notice of the time, place and purpose of said meeting was given, all as required by Vernon's Ann. Civ. St. Article 6252-17.

3. That the mayor of said City has approved and hereby approves the aforesaid ordinance; that the mayor and the city secretary of said city have duly signed said ordinance; and that the mayor and city secretary of said city hereby declare that their signing of this certificate shall constitute the signing of the attached and following copy of said ordinance for all purposes.

Next discussed was a scrambler for the police department radio. Item was tabled for further study.

Extra warranty on the new police car was discussed. It is to be reconsidered after car mileage reaches 8,000 to 10,000 miles.

Next considered was a selling permit for Southern Star Seafoods for 90 days. After consideration, Tidwell moved permit be granted (90 days, \$50.00 fee). Brown seconded. All for.

The next business was consideration of early purchase of Farmers Home Administration 5% bonds owed by the City. Mayor Dickerson presented figures to show the discount purchase offer would result in less savings than first thought. Discussion. Andrade moved to decline the early purchase offer. Brown seconded. All in favor. Council decision was to not run a

"Meter Tampering Now a Crime" ad, citing most people realize it is now a crime.

Andrade moved the 1975 pickup price be lowered to \$600 cash. Tucker seconded. All for.

The Council instructed the city administrator to order signs stating "No thru trucks" and to install same on third avenue at Main St. and on Hwy 277 (both ends of street).

Tidwell moved bills be paid as follows: from airport funds, \$46.91; from ambulance funds, \$250.76; from swimming pool funds, \$1,060.95; from operating funds, \$13,582.30. Andrade seconded. All members voted in favor.

Tidwell moved to adjourn. Tucker seconded. Motion carried.

DAD'S DAY GIFTS



All Mens' Dress Pants by Haggard and Levis Values to \$29.00

All Mens' Dress and Casual Shoes by Freeman and Jarman Values to \$69.00



NOW 1/3 OFF

Thursday, Friday and Saturday Have a Happy Father's Day!

The Fair Store Munday, Texas

Hot Prices



Tylenol Extra Strength Caplets, 50's, Reg. \$6.01... **\$3.49**

Polident Tablets, 40's, Reg. \$3.25... **\$1.99**

Alka-Selzer, 24's, Reg. \$2.92... **\$1.89**

Energizer Batteries, Size AA, 4's, Reg. \$4.40... **\$2.39**

Pkg. of 5 Good News Disp. Pivot Razors, Reg. \$2.39... **\$1.29**

Medal Isopropyl Alcohol, Pint, Reg. \$1.02... **34¢**

Style Hairspray, 8 oz., unscented, Reg. \$1.77... **\$1.19**

Sea Breeze, Reg. Formula, 10 oz., Reg. \$4.79... **\$3.09**

Smith DRUG PHONE (817) 422-4552 120 WEST MAIN • MUNDAY, TEXAS 76371



The Munday Courier

(ISSN 8750-6750) Munday, Texas 76371 Phone 817-422-4314

Marion Waggoner, Publisher Mrs. Joyce Nix, Editor Published at Munday, Texas 76371 every Thursday, except the first week in July.

Entered as second class mail at the post office at Munday, Texas, Nov. 11, 1971. Second class postage paid at Munday, Texas 76371. Publication number 917740.

CHANGE OF ADDRESS Should be mailed to: The Munday Courier, Box 130, Munday, Texas 76371.

SUBSCRIPTION RATES Knox County \$9.50 One Year in Texas \$13.00 One Year Elsewhere \$15.00

NOTICE: Any erroneous reflection upon the character, standing or reputation of any person, firm or corporation which may appear in the columns of the paper will be gladly corrected upon the notice of same being brought to the attention of the publisher.

CAMPERS • VACATIONERS • FUN SEEKERS
IT'S TIME

Hit the road. Stretch out on the beach. Shoot a round of golf. Or get out on the court for a set or two. Finally, you've got the time to truly enjoy the good life you've worked so hard to earn. So do what you've been dreaming about all these years. But whatever you do, leave your money worries behind. That's our job.

We're your Independent Bank,

We can set up a program that will assist you in making the most of your leisure time. We'll do it right, because we know you, your lifestyle, and your resources.

You've retired, but we'll continue to work hard on your behalf.

First National Bank IN MUNDAY

"Your Satisfaction Is Our Security"



BANK AT HOME

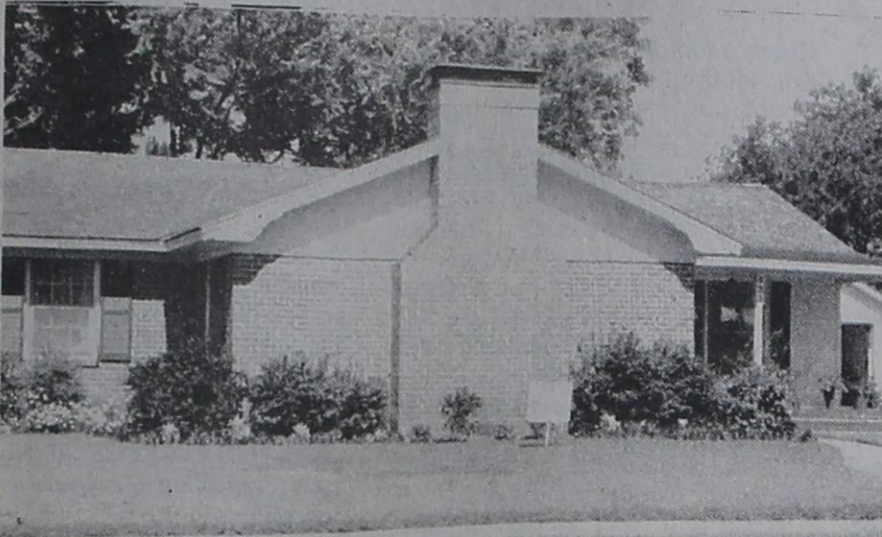

RED PHLOX BORDER the red brick home of Mr. and Mrs. Weldon Smith at 451 S. 11th in Munday. A neat look is popular in Munday yards, and this yard, with its background of shade trees and shrubs in front, captures that look perfectly. White blossoms mingle for contrast, and pot plants on the steps complete this Yard of the Week.

★ VERA HAPPENINGS ★

By Mrs. Thelma Coulston

Visiting in the home of Mr. and Mrs. K.B. Ritchie on Saturday were a granddaughter, Annette Parham and a friend, Cole Cordell of Amarillo, Mrs. Doris Hardin of Seymour and Mr. and Mrs. Keith Hardin of Graham. Sunday, K.B. and Nina attended church services in Abilene and visited Mr. and Mrs. Cecil Welch in Anson.

Josh, Elizabeth and Adam Beck have returned home after spending several days with their grandparents, Mr. and Mrs. Harold Beck. They are the children of Kent and Elaine Beck in Duncan, Okla. Also visiting in the Harold Beck home were Mrs. Lessie McGaughey of Knox City and Mrs. Wanda Stewart of Albuquerque, N.M.

This is the year of Vera's homecoming, which will be held on Saturday evening and Sunday, Labor Day weekend, September 5 and 6.

Visiting in the Duward home have been her son, Mr. and Mrs. Ronnie Sims and four children of Plain-

view, Pam Meinzer and son, Chance of Albuquerque, N.M., and Kenneth Sims of Tulsa.

Mrs. Vicki Berrier and little daughter, Jennifer, visited her parents, the Carl Coulstons, a few days last week.

Mr. and Mrs. Wayne Sutton were in Jacksboro Sunday where they attended the Pankey family reunion at the Jacksboro Armory.

Mrs. Loran Patterson returned home Thursday from a few days visit with her son, Mr. and Mrs. Richard Patterson and family and Pam Garrett and family in Plano, Kay Pruitt in Mesquite and also a visit with Bobby Thornhill of Seymour who is a patient in the Methodist Hospital in Dallas. While there she attended high school graduation exercises for a nephew, Shawn Garrett, in Plano.

The Eskimo make and use wooden "eyeglasses" with only narrow slits for eyepieces, to protect their eyes from the glare reflected by ice and snow.

Low Income Texans Eligible For Help

Some low-income Texans may be eligible for help in paying cooling bills this summer through the Home Energy Assistance Program, according to Texas Department of Human Services Commissioner Marlin Johnston.

Johnston said the one-time payment is available to many low-income households. Applications for energy assistance were mailed to households that received food stamps, Aid to Families with Dependent Children, or Supplemental Security Income in May. If those households have at least one member who will be 60 or older in 1987 or a member with a medical condition that is aggravated by heat, they may qualify for assistance. Other low-income individuals may request an application from local DHS offices during the enrollment period of June 15-July 17.

Eligibility is limited by gross income and resources. This year, because of budget cuts and participation rates, the benefits for the cooling program may be lower than last year's. Aid is available for a one-person household with less than \$555.49 gross income per month. The gross income limits are \$745.49 for households of two persons, \$935.49 for three, \$1,125.49 for four, \$1,315.49 for five, and \$1,505.49 for six.

Households are eligible if the cost for cooling is included in the rent payment or if the household pays a portion of its home energy costs.

Energy assistance checks are sent directly to the people who are eligible for assistance. However, the checks are made payable to the energy company.

Persons receiving one of these energy assistance checks should mail it or take it in person to the energy company business office with their regular energy bill. The check can be cashed only by the energy company. If the HEAP check is more than the energy bill, the additional amount will be credited to the person's account for the next month's bill. If the energy bill is higher than the check, the person is responsible for paying the difference.

Mammography Lab To Be Here Tuesday

The Breast Screening Mobile System will be in Munday from 9:30 to 12 noon Tuesday, June 23, to provide mammograms for interested women. The screening lab will be set up in the parking lot west of the City Hall. The test will take approximately 15 minutes and the cost is \$90.

Ann Baker of Numed, Inc., who administers the test, said if 10 or more women make appointments for mammograms, the price will be reduced to \$70 each. Appointments are preferred, and can be made by calling 915-695-2038 or 800-527-4159. Drop-ins will be accepted. If no more than five patients are scheduled, the system reserves the right to re-schedule patients.

The mobile testing service will be in Anson and Hamlin on Monday, and in Knox City Tuesday afternoon. The van will travel to Haskell and Throckmorton on Wednesday.

An average of 150 tornados hit the United States each year.



ANGELA ALBUS

Local Young Twirler Wins State Awards

Angela Albus, six-year-old daughter of Richard and Cathy Albus of Munday, participated in the National Baton Twirling Association state finals at Greenville June 12-14. Approximately 350 youngsters from throughout the state competed at the meet.

In Saturday's basic skills competition, Angela placed second overall in the six-year-olds division. On Sunday she was judged first in modeling, second in solo twirling and fourth in basic strut.

Angela's twirling instructor is Rozlyn Love of Love Baton Twirling in Abilene, and she has been taking lessons for a year and a half.

True Value
HARDWARE STORES

HARDWARE VALUE OF THE MONTH

GREEN THUMB

White Supplies Last

8.88

1/2-Gal. Polyethylene Sprayer with 2 trial-size packs of Green Thumb® plant food, 36-in. vinyl hose. 235002

QUANTITIES LIMITED

H. B. C.

Home Building Center

817-422-4214 Munday, Texas

See Us For All Your Seed and Chemical Needs

COTTON SEED

Select 611 - Certified C13
Certified CAB CS

Also a good selection of
hybrid sudan and milo seed

Good stock of Phimet and Tamik
Chemicals

Zeissel Bros., Inc.
Fertilizer and Seed

422-4606 or 422-5221

Shopping For Price & Service?

—We Have BOTH!!!



VCR

\$249⁰⁰

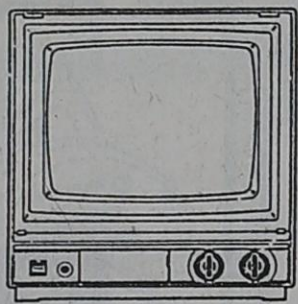

13" Portable Color Television

\$179⁰⁰

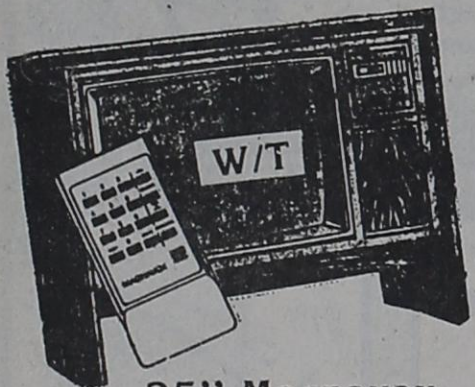

25" Magnavox

\$449⁰⁰

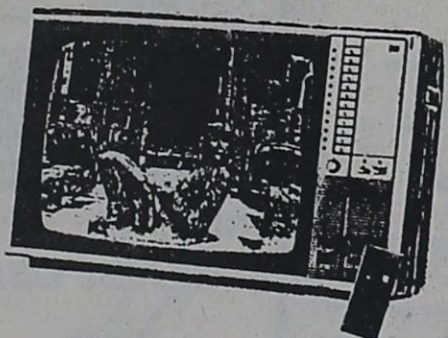

19" REMOTE CONTROL COLOR T.V.

\$299

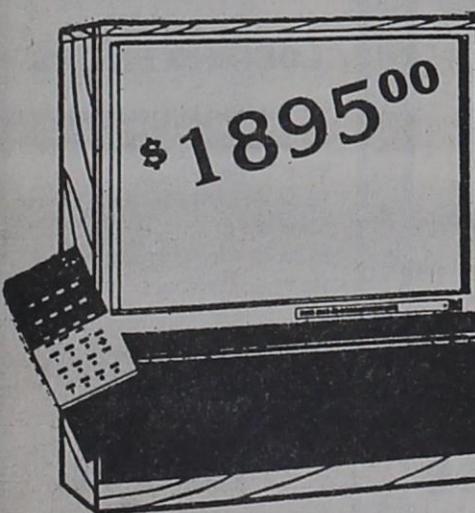

\$1895⁰⁰

Receive A Free Black & White T.V. With Purchase!!!

MAGNAVOX
37" diagonal Large Screen Computer Color 330 TV
• 120° black matrix projection screen
• 24-button Magnavox Universal remote
• Stereo hi-fi sound system

★ CREDIT AVAILABLE! ★

CROSSROADS ELECTRONICS

201 E. McLain

888-3515

BEATY'S

Grocery & Market

MUNDAY

TEK Soft, Medium or Firm

Toothbrushes.... 4/\$1.

Crest Reg., Mint, Gel, Tartar

Toothpaste... 4.6 oz. Pump \$1.59

Shurfresh

Cream Cheese.... 8 oz. 79¢

Birdseye

Cool Whip..... 8 oz. 89¢

Eggo Home Style

Waffles..... 17 oz. \$1.35

Shurfine Frozen

Donuts..... 14 oz. \$1.29

Glad 30 gal.

Trash Bags..... 10 ct. \$1.29

Job Squad Super

Towels..... Roll 89¢

Family Size Reg. or Unscented

Tide..... 147 oz. \$6.69

Family Size

Cascade..... \$2.89

Reg Delicious Washington

Apples..... LB. 59¢

Cabbage..... LB. 16¢

Lemons..... 5/\$1.

Broccoli..... LB. 45¢

Keebler Graham Cracker

Pie Crust..... 9 in 89¢

Shurfine Cherry

Pie Filling..... 21 oz. 98¢

Blue Bell Bullets^{12 pk.} \$1.29

Heinz Squeeze Bottle

Ketchup..... 32 oz. \$1.29

Gooch

German Sausage^{12 Oz. Pkg.} \$1.39

Fryer Thighs..... 6 pk. 89¢

Fryer Breast... 4 pk. \$1.19

Shurfresh Medium

Eggs..... Dozen 55¢

Spare Ribs..... LB. \$1.79

Shurfresh

Bologna..... LB. \$1.29

Mrs. Baird's Large or Thin Sliced

Bread..... 1 1/2 lb. Loaf 69¢

★ BENJAMIN NEWS ★

By Mrs. Gladene Green



MRS. MAUDE REAGAN celebrated her 95th birthday Monday, June 15, at the Munday Nursing Center. Mrs. Reagan was born in 1892 in Jones County and moved to Knox County when she married Arthur A. Reagan. The couple lived in this area all their married life. He died in 1956. Mrs. Reagan was active in the First Baptist Church in Munday until a fall resulted in a broken hip and forced her move to the nursing home several years ago. Of her six children, four are living. They are Ruby E. West, who also lives at the nursing home, Annie B. Lain and Frances Cypert, both of Munday, and J.C. Reagan of Crosbyton. She also has 18 grandchildren, 18 great-grandchildren and three great-great-grandchildren.

★ TRUSCOTT-GILLILAND NEWS ★

By Mrs. Clara Brown

The sunshine didn't hold out last week so harvest got put on hold for a few days. By Friday combines were back in the fields again and Saturday and Sunday harvest was in full storm around Truscott and Gilliland although showers Saturday stopped cutting for a while at Foard City and Crowell. Monday morning came on bright and clear with some custom cutters preparing to move north and others ready to finish up their contracts here.

Most people are reporting good averages on their wheat, much better than they had expected after the late freeze and then the dry weather that held on just when the heads were filling out in late spring.

Grandma served dinner to 60 at the community center Sunday. She'll be having company again July 12.

Richard Jones is in Bethania Hospital following a heart attack.

Thelma Jamison spent the night with her sister, Mrs. Pete Mayberry of Vernon, the weekend of June 6. Sunday she went with her granddaughter, Debra Myers, to get their pickup at Iowa Park and then on to their home near Jean.

Jimmie and Cathy New and family of Jean were supper guests in the home of his parents, Mr. and Mrs. Owen New, on Saturday.

Norma Lee of Vernon attended the Truscott Church of Christ Sunday, ate dinner with Grandma at the center, and spent the afternoon visiting her father, Edgar Jones, and brother, Vernon Jones.

The Hord family reunion is set for this coming weekend. They would be glad to have friends drop by to visit when they gather at the Truscott Community Center. The next weekend, June 28, the J.D. Smith family will be gathering at the Truscott center.

Another reunion is being planned for July 18. It will be the Pioneer and Ranch Reunion at the Knox County Ranch Day in Benjamin. As plans stand at the moment, arena events will be in the morning and the reunion will be in the afternoon at the air-conditioned memorial build-

ing. Truscott and Gilliland will make a special effort to notify anyone who has worked on a Knox County ranch in our communities or who had relatives who worked on one. This will be an opportunity for some good visiting plus the Knox County Historical Commission hopes to get information that day about ranchers, cowboys, and other ranch workers that can go into the archives of the planned Knox County Museum.

The Ranch Day is a fund raising project for the museum which many people have hoped for and worked for in past years. It is getting closer to reality, and finances are part of the reality. With over 70 ranches listed in "Between the Wichitas", Truscott and Gilliland should be able to turn out a good attendance at the reunion.

Does anyone have old time pictures they would like to display? More information is needed on the Newton F. Atkinson, W.T. Ball, Bomar, Bugbee, Luther T. Clark, Craig, Daggett, Dempsey, Farr, Fataman, Eight, Featherston, Garratson, Gunter, Foster, Hamby, JF, P8, Kilworth, Ratliff, Sheek, Stevens, Turner, Childers, Glascoe, and Hinton and Stewart ranching interests. These are mostly the older ranches which no longer exist under those names.

Mrs. Martha Riley of Seymour is visiting her daughter, Mrs. J.C. Langston.

Joyce Williams of Floydada visited her father, Edgar Jones, Friday through Saturday, and also attended the mid 40's class reunion at Crowell Friday and Saturday.

She said several people at the class reunion had nice things to say about "Between the Wichitas". One family history hobbyist said he bought the book even though he had never lived at Truscott or Gilliland. He called it one of the best community history books for genealogical references that he had seen. Everyone who contributed a family story or helped in any way shares in that compliment, and there are scores of people who helped.

ATTEND GRADUATION

LaMoyné and Christine Patterson and LaNay and Kim Cash were in Amarillo last week to visit the Oral Lynn Patterson family and to attend the Palo Duro Amarillo High School graduation. The LaMoyné Pattersons' granddaughter, Danneva Rae Patterson, was one of the 302 graduates.

Danneva graduated with an 85.3254 grade average on 38 credit courses. She was elected to Who's Who Among American High School students and was named an academic All-American National Award winner. She was on the school honor roll, voted most athletic girl, serving as volleyball team captain. She also played basketball. She was elected most dedicated volleyball player, received the U.S. Army Reserve National Scholar/athlete award and the High School Dona Award. She served on the student council three years and on the annual staff as sports editor and was a member of the Spanish Club and the Publication Club. She was also runner-up for Homecoming Queen.

Danneva plans to attend Amarillo Junior College in the fall majoring in journalism.

HERE AND THERE

Approximately 65 persons attended the annual Coody reunion Sunday at the Benjamin Memorial Building. Lots of visiting, recalling old times, catching up on new happenings and a delicious catered meal, by Harold's of Abilene, was enjoyed by those in attendance.

Joy Yancey and granddaughter, Kerri of Wichita Falls, spent the weekend with the Dutch Youngs. They also visited Slick and Darlene Benson and Jane Nunley and family.

Cathy Tomlinson and family of Valley View and Vickie Clower of Grapevine visited the Leroy Wests and the Bud Clowers several days last week. Betty Parker of Aspermont visited them on Saturday.

Kenneth and Jessie Roberts left Friday morning on an extended vacation trip which will take them through the northwestern states and into Alaska. We will be looking forward to a detailed report after their return home.

Cody Taylor of Munday spent Friday night with his grandparents, Van and Gladene Green.

Homer T. and Kathleen Melton

were in Lubbock the last of the week for H.T. to have a checkup. His doctors say he is doing pretty good and Homer T. says he agrees with them. That's good to hear.

Benjamin-ites Jack Whitten, Shannon Parker and Julia Trepanier have all been patients in the Seymour Hospital during the past week. Jack returned home Friday and Julia and Shannon were to be released Monday if their progress continued. We wish them all well.

Todd and Vernon Benson have taken over the Shamrock station formerly owned by Steve Conner. The Bensons invite their friends by to visit them.

Imogean Young entertained her family, Dee Ann Lamb and Anthony, Brenda Golleher of Wichita Falls, the Mike Youngs of Seymour and Joy Yancey and Kerri, also of Wichita Falls, with a dinner on Saturday night to celebrate Anthony's first birthday and also Father's Day early.

Visiting Earlene Meinzer during the weekend and attending the

Coody reunion were Gene and Sandra House and boys and Linda Gooch and children of Arlington, Nila Beth Swanner of Tyler, Betty Meinzer and granddaughter, Sara Phillips of Hale Center, Mr. and Mrs. Joe David Meinzer of Idalou, Mr. and Mrs. Lewis Meinzer of Childress, Rick, Patsy and Trapper Meinzer of Munday and Pate and Hunter Meinzer of Benjamin and Robin Gooch of Arlington.

Mike and Jean House and girls of Arlington visited Dick and Laura McCanlies Saturday night and attended the Coody reunion Sunday.

Craig and Kent Hertel, students at Texas Tech in Lubbock, were weekend guests of their parents, Don and Louise Hertel.

Hes and Louise Hall visited the Don Halls in Lubbock recently.

Alvin Alexander and family of Matador were Benjamin visitors last week.

Judy Conner was in Oklahoma City last Friday for a checkup with a bone specialist.

A familiar sight in Benjamin is being done away with. The building which housed Hazel's Cafe for many years and the house behind it is being torn down. The demolition began last week and probably will be completed before very long.

Miss Bell Graduates From Dallas School

Michelle Nichole Bell, a 1987 graduate of Lexington Academy, a Dallas private school, was recently honored with a pool party hosted by her cousins Toya and Arthur Kaplan and Tava and Al Brice at the Kaplan home. Special guests were her parents, Mr. and Mrs. Bobby Dee Bell Sr., of Addison, her sister, Mr. and Mrs. Michael Brown of Lewisville, and her brother, Bobby Dee Bell, Jr.

Miss Bell graduated in June 7 commencement exercises and was salutatorian of her class. She received the honor roll award four consecutive years and was chosen to represent the school in poetry and short story in a nationwide competition at Oral Roberts University in 1986. She was involved in the drum and pipe corps and choir and received the school spirit award.

The granddaughter of Vera and Riley Bell of Goree, Miss Bell will begin classes at the Court Reporting Institute of Dallas in September.

The mosquito has 47 teeth.

DAD'S DAY

SKILSAW.

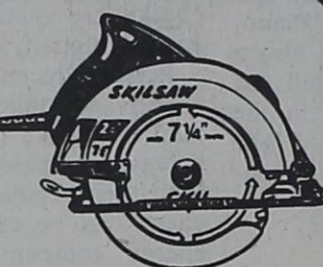

7 1/4" CIRCULAR SAW

Power and many top of the line features at a very attractive price.

- * Powerful, high torque motor.
- * 2 1/4 H.P., 4,600 RPM
- * Ball bearing construction
- * Convenient blade wrench storage
- * Textured front and rear handles
- * Handy scales and cutting guides

No. 46-0567 OSBORNES **\$42.88**

BLACK & DECKER™

3/8" VSR DRILL



- * M47 Series(TM) motor for more power — higher torque.
- * Compact, better balanced and easier to handle.
- * 3 position switch — forward, reverse and off.
- * Backside of drill designed so greater hand pressure can be applied to drill bit.
- * Exclusive chuck key clips on cord to prevent loss and makes chuck tightening easier.

No. 46-1304 OSBORNES Sale Price **\$28.88**
Less Mfg. Mail-In Rebate **-5.00**
Your Net Cost **\$23.88**
After Rebate

\$5.00 Mail-In Rebate

BLACK & DECKER™

1 1/2 HP (max. motor output) 7 1/4" CIRCULAR SAW

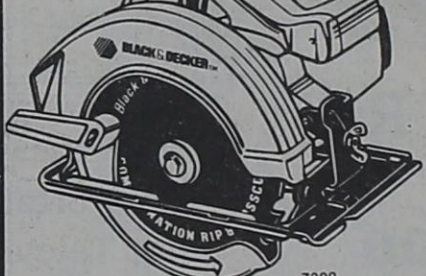

- * Wraparound steel shoe.
- * Two handles for control.
- * Includes 7 1/4" combination blade.

No. 46-1314 OSBORNES Sale Price **\$32.88**
Less Mfg. Mail-In Rebate **-5.00**
Your Net Cost **\$27.88**
After Rebate

\$5.00 Mail-In Rebate

SKIL



CORDLESS SCREWDRIVER

Your manual screwdriver just became obsolete.

- * 1/4" hex collet
- * Unique power screwdriver
- * Drives and removes a wide range of screws
- * Phillips-slotted bit included
- * Recharging stand/always ready to use

No. 46-0568 OSBORNES **\$17.88**

HOMAK

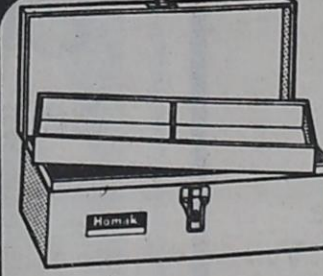

15" UTILITY TOOL BOX

These boxes are perfect for small tools and parts, hobby materials, office use — partitioned tray adds to versatility. Tray has two partitions. Features a single drawbolt with padlock eye.

No. 50-0304 OSBORNES **\$9.88**

VAUGHAN



THE ORIGINAL SUPERBAR — A MOST USEFUL HAND TOOL

- * Use it to open stubborn windows, remove molding, lift sagging doors and frames during repair
- * Unique, "shepherd's crook" rocker head pulls the biggest nails easily
- * Makes a great paint scraper and shingle remover
- * Made extra long for super leverage
- * Forged of heavy spring steel; blades ground sharp for easy insertion under nails in woodwork

No. 43-1042 OSBORNES **\$5.88**

WISE-GRIP

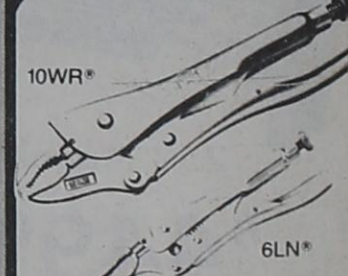

6" or 10" LOCKING PLIERS

- * 10" curved jaw locking pliers
- * 6" long nose locking pliers
- * Won't slip
- * Lock on instantly and release quickly
- * Built-in wire cutter
- * Heavy-duty construction

No. 43-0324,0328 OSBORNES YOUR CHOICE **\$6.88**

Commodity Reports LIVE

From Cimarron Commodities in Seymour

The complete reports are broadcast at 10:05 a.m., 12:05 p.m. and 2:05 p.m. every day - Monday through Friday



1230 AM

"Your Farm & Ranch News Station"



True Value OF THE MONTH

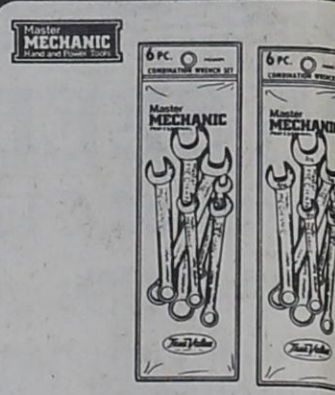

9.99 While Supplies Last
Two 6-Pc. Combination Wrench Sets incl. SAE and metric wrenches, all drop-forged for strength. MODEL/M0661/M. QUANTITIES LIMITED



Home Building Center 317-422-4214 Munday, Texas

OSBORNES

241 W. Main 422-4851 Munday

Prices Good Thru June 23, 1987

FATHER'S DAY GIFT IDEAS!

WEED EATER

MODEL 1210

- 10" cutting path
- Tap-N-Go® automatic line advance
- 2.8 amp motor
- Adjustable assist handle
- One-year limited warranty
- Lightweight, 4 lbs.

No. 57-651

ONLY

\$26⁸⁸



MODEL 1214

- Motor rotates 180° for easy edging
- 14" cutting path
- Tap-N-Go® automatic line advance
- 3.5 amp motor
- Adjustable assist handle
- One-year limited warranty

No. 57-650

ONLY

\$32⁸⁸

BLACK & DECKER™

No. 46-31

.375 H.P. Utility ELECTRIC EDGER

\$49⁸⁸

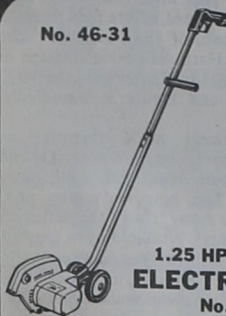

1.25 HP Heavy Duty ELECTRIC EDGER

No. 46-64

\$64⁸⁸



WHEELBARROWS



KELLEY 4 CU. FT. WHEEL BARROW

- ★ STEEL TUB
- ★ PNEUMATIC TIRE
- ★ HARD WOOD HANDLES
- ★ MADE IN U.S.A.

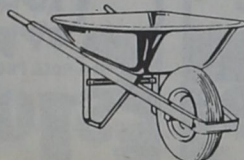

No. 55-171

\$24⁹⁵

Assembled

HOMELITE JACOBSEN

15" GASOLINE STRING TRIMMER

No. 46-2054

\$79⁹⁵

Less \$10⁰⁰

Mail-in Rebate

\$69⁹⁵

Your Cost
After Rebate

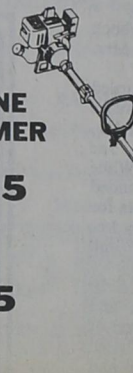

17" GASOLINE BRUSH CUTTER

No. 46-2056

\$119⁹⁵

LAWN MOWER SALE



Terrific values now available on several models of lawnmowers, tillers, and edgers — just in time for Father's Day! All units are assembled, serviced, and ready to go. Choose from the largest selection of lawn and garden equipment in the area at the lowest prices anywhere!

Financing available to qualified buyers.

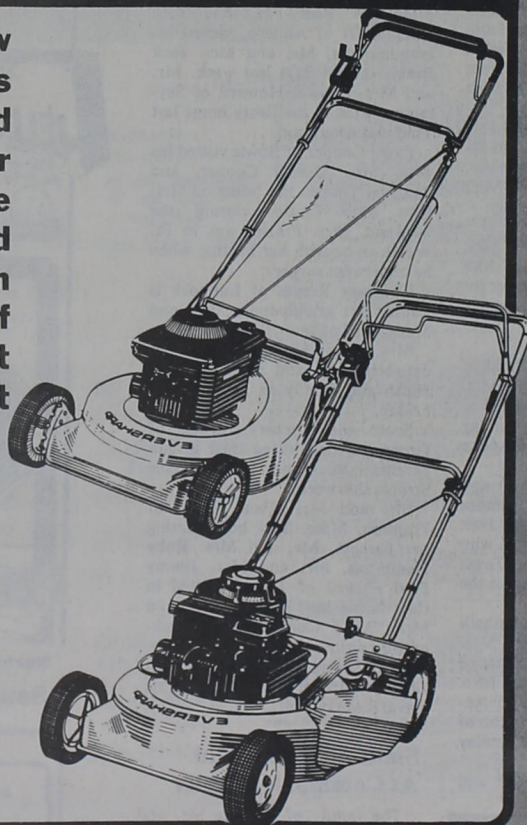

OSBORNE

Munday, Texas

Phone 422-4851

Prices Good Thru June 23, 1987

★ Goree News ★

By Mrs. Grace Smith

HOSPITAL NOTES

Ray Harlan underwent foot surgery at the Bethania Hospital in Wichita Falls on Friday. He is reported to be recovering nicely.

Mrs. Frances Smith received medical treatment at Hendrick Medical Center in Abilene. She returned home Sunday.

Mrs. Audrey Cooke returned home last Wednesday after spending several days at Ft. Worth receiving medical treatment. Mrs. Cook's son-in-law, Ralph Forsberg of Alvarado, brought her home on Wednesday and visited here.

HOMECOMING COMMITTEE MEETS

The Goree School Homecoming Committee, including Mrs. JoAnn Marr of Munday, Donna Cotton, Bernese Steward, Grace Smith and Candy Estes, met at the home of Mrs. Peggy Myers last Tuesday evening to make plans for the homecoming.

Saturday, October 17, 1987, has been set for the date of the homecoming. The homecoming football game will be played Friday evening, October 16, when the Goree Wildcats will play the Weintert Bulldogs.

On Saturday, a meal will be served at the noon hour with serving time from 11:30 a.m. until 1:00 p.m. A program will follow beginning at 2 p.m. More information will be published at a later date.

ATTEND REUNIONS

The Blankenship reunion was held at McKinney on Saturday. All of the Blankenship children were present for this occasion except Mrs. Pat Davis of Weintert. Attending were Mr. and Mrs. Louis Blankenship of San Antonio, Mr. and Mrs. Tuck Blankenship of Paducah, Mr. and Mrs. Taylor Allen of Goree, Mr. and Mrs. Joe Blankenship and Jeff of Killeen, Mr. and Mrs. Wayne Feemster and Mr. and Mrs. Joe Wayne Feemster and Shelly of Hurst, Mr. and Mrs. Jim Wagner and children of Ft. Worth, Mr. and Mrs. Cordas Ray Lambeth, Crystal and Cody Choate and Terry Lambeth and Brad of Wichita Falls, Mr. and Mrs. Gene Adkins of McKinney, Eric Boyd of Sweetwater and Judy Wallner and Rachel of College Station.

KEVEL REUNION HELD

Mr. and Mrs. Ewen Beaty attended the Kevel reunion at Rock Creek on Lake Kickapoo during the weekend. A large group of Kevel relatives attended.

KIRK REUNION

The Kirk cousins met on Saturday at the Country Club in Nocona for a family reunion. Attending from Goree were Mr. and Mrs. Felton Lambeth and Mrs. Louis Hutchens and her daughter, Mrs. Glenda Rich from Lubbock.

ATTEND WEDDING

Mr. and Mrs. Joe Birkenfeld attended the wedding of her niece, Miss Margaret Smajstria, and Matt Rodgers in Seymour on Saturday.

ATTEND ANNIVERSARY

Mrs. Dewitt Green and Mrs. Hallie Campbell attended the 50th wedding anniversary celebration for Mr. and Mrs. Fred Green in Graham on Friday.

HERE AND THERE

Rev. and Mrs. Pete Bradfield of Graham were dinner guests of Mrs. Virginia Land after he preached at First Baptist Church here on Sunday morning. Rev. Bradfield also spoke at the evening service.

Mr. and Mrs. Greg Melton and Taylor of Haskell were dinner guests on Sunday in the Jack Steward home. James Steward, who is attending school at North Texas State University in Denton spent the weekend visiting his parents.

Visiting Mrs. Winnie Lambeth several days last week were Mrs. Cindy Brand and children, Suzanne and Rodney, of Midland and Mrs. Lisa Wells and Christopher of Andrews. Mr. and Mrs. Dave Jetton of Munday visited in her home Sunday afternoon.

Billy Simaichl of Seymour and

Jonathan Smith of Munday visited their grandmother, Mrs. Grace Smith, last Thursday evening.

Mrs. Nina Redding visited Mrs. Pat Davis in Wichita Falls last Thursday.

Mr. and Mrs. L.O. Chamberlain spent five days in Farmers Branch last week with her daughter and husband, Mr. and Mrs. Ronald Coody, while Ronald underwent surgery at the R.M.D. Memorial Hospital in Farmers Branch and while he was convalescing. On Saturday they went to Conroe to join her son and family, Mr. and Mrs. Jimmie Rounton and Cheryl of Lubbock, who were vacationing there.

Bill Williams and John of Eules visited his father, Mr. and Mrs. Grady Williams, several days last week. They were enroute home from a vacation in Colorado.

Visiting Mrs. Winnie Howry during the weekend were her son and family, Mr. and Mrs. Jackie Howry, Melanie and Beckie of Wichita Falls.

Mrs. Ruth Hammons and Mrs. Grace Smith were Haskell visitors last Wednesday.

Mrs. Eva Atwood of Seymour visited her father, Mr. and Mrs. Eldon McSwain, on Sunday.

Mrs. Jack Beaty received word this week of the death of her brother-in-law, B.O. Koonce at Desdemona. Mr. Koonce was the brother of Mrs. Vera (Cane) Brown, a long-time resident of this area.

Courtney Reeves of Lubbock visited her great-grandmother, Mrs. Ruth Coffman, on Sunday.

Mrs. Gladys Lambeth returned home last Sunday from a two weeks visit with her son and family, Mr. and Mrs. Billy Lee Lambeth, Joe David and Anna in Lubbock. While visiting in Lubbock she attended high school graduation exercises for her grandson, Joe David. Billy Lee brought his mother home and visited here.

Weekend guests in the L.O. Chamberlain home were Mr. and Mrs. Jimmie Rounton and Cheryl of Lubbock, Mr. and Mrs. Russell Rounton and DeNae of Merkel and Mr. and Mrs. Randy Rounton of Irving.

Visiting Mr. and Mrs. Wallace Roberts this week are her daughters, Mrs. Jimmie Dale Moore of Athens and Mrs. Anna Marie Latta of Mulberry, Florida. The ladies will also be visiting Mr. and Mrs. Johnny Peysen and Rhonda at Knox City, their grandmother, Mrs. Genevieve Taylor of Goree and relatives at Munday.

Douglas Beaty Jr. and son, Douglas III of Abilene, visited his grandparents, Mr. and Mrs. Jack Beaty, several days last week. Mr. and Mrs. Modrel Howard of Seymour visited in the Beaty home last Thursday afternoon.

Floyd Cooper of Bowie visited his wife, Mrs. Donna Cooper, and daughter Desi in the home of Mrs. Etta Mae Frazier during the weekend. Mrs. Frazier was in Ft. Worth to be with her brother when he underwent surgery.

Courtney Reeves of Lubbock is visiting her grandparents, Mr. and Mrs. Don Coffman, this week.

Mrs. Virginia Land visited her daughter, Mr. and Mrs. Glendon Hicks and family in Seymour on Friday.

Scott and Zachery Struck of Grapevine are visiting their grandparents, Mr. and Mrs. Archie Struck, this week.

Mr. and Mrs. Paul Noren of Franklin, Mass. have been visiting her parents, Mr. and Mrs. Ruby Hammons. Mr. and Mrs. Jimmy Paul Howell of Joshua visited in their home last Tuesday. Mr. and Mrs. Ward Cooksey of Throckmorton visited on Sunday.

Kipp Cotton left Sunday for San Diego, Calif. for two weeks with his Naval Reserve Unit.

Smith Reunion Held At Community Center

The family of the late Mr. and Mrs. C.N. Smith met at the Community Center Saturday, June 13, for a family get-together. Sixty-four members registered and all reported an enjoyable day.

Family members came from Dallas, Lewisville, Ft. Worth, Stephenville, Hurst, Watuga, Houston, Austin, Abilene, Lubbock, Breckenridge, Haskell, El Paso, Corpus Christi, Springtown and San Antonio.

On August 18, 1975, an inn keeper in England received a telephone bill for the equivalent of \$4,386,800,000. It was later found that this bill contained "an arithmetical error."

Sorghum Growers Call For Deficiency Payment Release

Final deficiency payments on 1986 grain crops should be paid now, not next October, according to the national sorghum association. The National Grain Sorghum Producers Association (NGSPA) has requested that payments be based on the first five months of the marketing year and paid promptly.

"There is no justification for making grain producers wait more than a year after their crops have been harvested before they receive a large part of their income," said Elbert Harp, executive director of NGSPA, in letters to the U.S. Senate and House of Representatives.

"Farmers made financial arrangements for producing the 1986 crop more than a year ago," Harp said. "They borrowed money, planning to repay it with the deficiency payments. Withholding a part of that payment has increased the farmers' debt load, lengthened their interest payments and added to their losses."

A bill to speed the final 1986 feed grains deficiency payments came out of the House Agriculture Committee last week. A similar measure has been proposed, without success, in the Senate. Senate opposition comes from the fact that the payments, if paid now, would have to come from the 1987 budget rather than 1988. USDA has not announced the form of the final payments but a large proportion is expected to be in generic certificates.

The remaining deficiency payment is the difference between the basic loan provided in the Agricultural Act of 1985 and the adjusted loan set by the Secretary of Agriculture for the 1986 crop. In 1986, the basic loan for sorghum and corn was \$2.28 and \$2.40 per bushel, respectively. The adjusted loan is \$1.82/bu. for sorghum and \$1.92/bu. for corn.

"The amount due producers--and being withheld--is 16 percent of the target price," Harp said. "In most cases, the target price is a farmer's gross income. When profit margins are only two or three percent (or less), as they are for most feed grains producers now, that sixteen percent payment is very important."

For one cup of honey a recipe calls for, you can use instead a cup and a quarter of sugar plus a quarter cup of liquid.



DRESSED IN THEIR best country finery, these students at Goree School were participants in an end-of-school production of Hee-Haw who portrayed their impression of the Country Clogger square dance group. In back row are Mike Hernandez, Dustin Hord, James Phillips and Leah Lohman. Skirt-swingers in the front row are Minnie Nava, Audra Lohman, Tanya Greenwood and Anna Marie Waldrip.

Federal Income Tax-Free* Municipal Bonds 7.80% <small>*Interest may be subject to state or local taxes</small>	Investment Grade Corporate Bonds 10.30%	U.S. Government Guaranteed Bonds 8.54% Guaranteed as to principal & interest
Edward D. Jones & Co. <small>Member New York Stock Exchange, Inc. Member National Securities Dealers' Association, Inc.</small>		Don Book 118 S. Swenson Stamford, Texas
915-773-2709		

ASSTD. SPAGHETTI Prego Sauce 32 OZ. JAR \$1.69	Kool-Aid ASSTD. FLAVORS Kool-Aid Koolers 3 CT. PAK 79¢	LAUNDRY DETERGENT \$1.50 OFF LABEL Tide Family Tide 147 OZ. BOX \$6.99	BATHROOM Charmin Tissue 4 ROLL PKG. \$1.09
TENDERCRUST SAND. WHEAT Bread 79¢ 1 1/2 LB. LOAF SHelf SPECIALS Assorted Flavors Geteltn JELL-O 3 oz. Boxes 2/79¢	PEANUT BUTTER SMOOTH OR CRUNCHY JIF 18 OZ. \$1.99	Aunt Jemima Yellow or White Cornbread Mix 4/\$1.	40¢ Off Label Dish Detergent Joy Liquid 22 oz. Btl. \$1.09
Pampers DIAPERS 48 MED./32 LARGE Pampers BOX \$8.99	Gatorade 32 oz. Jar 89¢	Mrs. Tucker's Pre-Creamed Shortening 42 oz. Can 99¢	60¢ Off Label Cascade 65 Oz. Box 2.89
Hormel HORMEL SUPER SELECT LEAN TRIM FAMILY PACK 8-11 ASSTD. Pork Chops \$1.69 LB.		Instant Tea Lipton 3 Oz. Jar 249	
HICKORY SMOKED SLICED SLAB Wright's Bacon LB. \$1.59		Assorted Flavored Assorted Flavored Drinks FAYGO 4/\$1	
Shurfresh Whole Hog Sausage LB. \$1.69	Pork Ribs LB. \$1.79	CALIFORNIA NEW CROP SEEDLESS White Grapes 99¢ LB.	
FROZEN FOODS Assorted Flavors Yogurt YOPLAIT 6 oz. container 2/99¢		2 Pot-Ritz Pie Crust Shells in Deep Dish 2 Ct. Pkg. 99¢	
Shurfresh Medium EGGS Dozen Carton (Pink) 2/99¢		Trainham Venture Foods Goree, Texas PRICES EFFECTIVE JUNE 14-20, 1987 the price fighter Venture FOODS WE RESERVE THE RIGHT TO LIMIT	
		Always Fresh MILK Gal. \$1.99	

- 24 hour Wrecker Service
- Auto Painting
- Windshield Installed
- Body Repair
- Guaranteed Work

Ramirez
Paint & Body
Shop
Haskell Highway
Munday
Phone 422-4871



MUNDAY JUNIOR HIGH twirlers attended the 1987 Big Country Front Line Camp at Hardin-Simmons University last week. The girls received training from a four-member twirling staff headed by Donna Oakley Nall of Abilene, a former college feature twirler and well-known twirling instructor. Shown in the photo are, top, Misti Zeissel; center, Kammi Haynie; and bottom, Brandy Branam, left, and Tonya Kuehler, right.

Area Students Earn Angelo Distinction

Several area students were listed on Dean's honor rolls at Angelo State University for the spring semester.

Laura Myers, a freshman accounting major, Ron Redder, a sophomore business major, and Neil Waggoner, freshman business

major, attained the 3.00 to 3.49 honor roll. They are all graduates of Munday High School and are the children of Mr. and Mrs. Billie Jake Myers, Mr. and Mrs. Rhiney Redder and Mr. and Mrs. M.L. Waggoner.

Also listed on the 3.00 to 3.49 honor roll were Steven Michael Lynn and Michael Rauch of Knox City.

Students receiving 3.50 to 4.00

recognition included freshman journalism major Kelly Wren, senior health and physical education major Danny Sloan and junior accounting major Paula Waggoner. Also MHS graduates, they are the children of the Jerry Wrens, Dan Sloans and M.L. Waggoners.

Another freshman journalism major, Rick Wupperman of Knox City, also qualified for the 3.50 to 4.00 honor roll.

Meinzer Exterior Siding Co.
Alside
 First On America's Homes
 Specializing in Steel Siding and Storm Windows
 Call RICK MEINZER
 (817) 422-4417

★ KNOX COUNTY KONNECTIONS ★

Jane Rowan
 County Extension Agent - Home Economics

With canning season upon us I thought the following would be helpful. If you have questions during the year, please give us a call at 454-2651.

CANNING FRUIT WITHOUT SUGAR

If you want to can fresh fruit and cut back on your sugar intake, try canning your own "lite" fruit.

Recipes for canning fruit normally call for adding sugar or a sugar syrup. The sugar helps maintain the texture, shape and color of the fruit as well as improve the flavor.

Since sugar doesn't regard spoilage, it can be omitted without compromising the safety of canned fruit. But the texture and flavor will not be as good in fruits canned with water or unsweetened juice.

When canning without added sugar, use only firm ripe or slightly overripe fruit. Overripe fruit has less acid and becomes too soft.

Prevent darkening of light colored fruit by adding ascorbic acid tablets or commercial anti-darkening preparations to the water or juice used to cover the fruit in the jar.

You can make fruit juice for canning by simmering crushed ripe fruit over low heat and straining it through a jelly bag or other cloth.

Processing times for the sugar-free fruit will be the same as for fruit packed in syrup.

Don't use artificial sweeteners in canning fruit. The heat of processing will cause some to become bitter and others to lose their sweetening power. You can add artificial sweetener when the fruit is served.

PROCESSING JELLIED FRUITS

The USDA recommendation to process jams, preserves, marmalades and butters in a boiling

waterbath has not changed and USDA does not anticipate a change in their processing recommendation for these jellied fruit products.

This is in response to instructions with General Foods pectin that recommends inverting jars for 5 minutes after closing. Their printed materials will continue to mention the USDA waterbath directions as an alternative.

The waterbath processing of jellied products (except jelly) is recommended for these reasons:

* The 5-minute waterbath process has proven adequate to prevent microbial growth and still result in a high quality product.

* The process exhausts oxygen from the headspace for a better seal and reduces oxidative color changes.

* General Food has indicated that they do not intend to publish their studies and USDA is standing by its commitment to base its recommendations on research data.

Birthdays And Anniversaries

June 18 - Sharla Riggs, Floyd Reed Jr., Aaron Kiser and Linda Bunton; W.O. and Brenda Smith and Mr. and Mrs. Danny Owens.

June 19 - B.B. Bowden and Kevin Hawkins.

June 21 - Barry Ratliff, Lanasa Wilson and Johnnie Smith; Jimmy and Phillis Urbanczyk.

June 22 - Sam Spann and Robyn Clem; Ronnie and Sherry Baker.

June 24 - Jonathon Phillips, Mrs. Jerry Kane and Jonathan Smith; Mr. and Mrs. Eugene A. Brown and Mr. and Mrs. W.O. Ratliff.

New Orleans is the oldest major city in the south.

For Quality Application When It Really Counts



CALL
Petty Flying Service
 817-422-4511

NOTICE TO GOREE CUSTOMERS
 For Cable Service
 Call
 422-5195

AUTOMOTIVE

REBATE ON AC SPARK PLUGS



REBATE ON AC SPARK PLUGS
 GET UP TO \$2 BACK (25¢ each on 8 AC Spark Plugs)
 On AC Spark Plugs that give up to 30,000 miles of performance. * REBATE ENDS JULY 18, 1987
 * See your owner's manual for specific recommended change intervals.

Resistor OSBORNES Sale Price	\$1.09
Less Mfg. 25¢/Plug Rebate	<u>-.25</u>
Your Net Cost After Rebate	84¢
Regular OSBORNES Sale Price	99¢
Less Mfg. 25¢/Plug Rebate	<u>-.25</u>
Your Net Cost After Rebate	74¢

Rebate Limit 8 Plugs

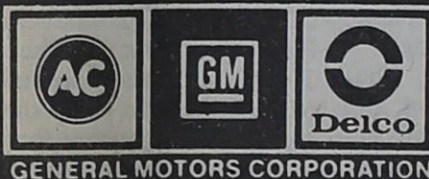

Stay ahead of trouble with AC-Delco.

SMART DELCO QUALITY

Delco Freedom Batteries

40 Month
 325 CCA
\$35⁹⁵
 FREE INSTALLATION



- Maintenance-free, never-add-water, no-worry batteries.
- Available in side and top-post terminals.
- Three series to suit your power, performance and price needs.
- Sizes to fit virtually every car and light truck on the road.
- Built-in hydrometer to show state of charge at a glance.
- Delco quality.

50 Month
 475 CCA
\$42⁹⁵
 FREE INSTALLATION



60 Month
 525 CCA
\$49⁹⁵
 FREE INSTALLATION



All Batteries Priced with Exchange

*Warranty based on length of ownership by original purchaser. Ask us for full warranty details.



AC-Delco. The smart parts.

OSBORNES

Munday

Prices Good Thru June 23, 1987

422-4851

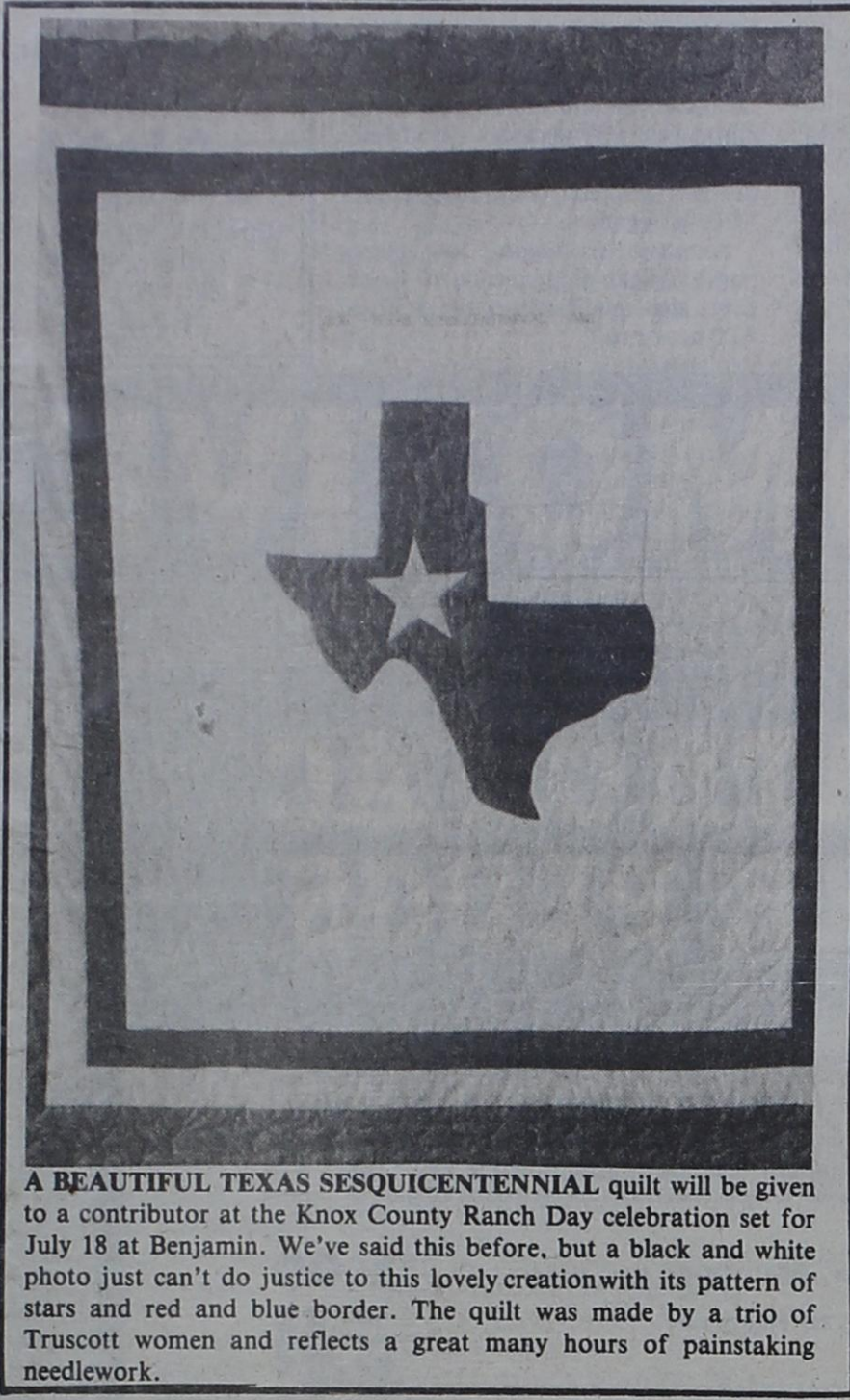

A BEAUTIFUL TEXAS SESQUICENTENNIAL quilt will be given to a contributor at the Knox County Ranch Day celebration set for July 18 at Benjamin. We've said this before, but a black and white photo just can't do justice to this lovely creation with its pattern of stars and red and blue border. The quilt was made by a trio of Truscott women and reflects a great many hours of painstaking needlework.

★ FARM AND RANCH REPORT ★
David Tunmire, County Agent

GARDENERS FACE A FEW GROWING PAINS

This is the time of year when problems begin developing in the vegetable garden. Frequent complaints are that tomatoes won't set fruit or that the fruit develops a rot on spot on the bottom end. Sometimes squash and cucumbers have fruit that won't develop. Most of these difficulties are related to the weather.

Tomatoes at this season come under stress from high temperatures and will stop setting fruit as days and nights continue to get warmer. Although it's not caused by a disease organism, blossom-end-rot may look like a fruit rot. The cells at the blossom end of the fruit die because of moisture stress, and the dead tissue continues to develop until it becomes a black, water-soaked area.

Calcium seems to be involved so spraying the plants with a calcium chloride solution or side dressing with a calcium nitrate fertilizer may help some. It is important to keep the plants watered in dry weather, and use a mulch. Too much nitrogen can prevent tomato blooms from setting, and using a small

amount of sugar -- about a teaspoon per plant, watered into the soil -- may help to temporarily tie up some nitrogen, slow down the plant growth and promote fruit setting.

Squash is a different story. The main problem has been a lack of pollination. The same is true of cucumbers. When the squash blossoms don't become pollinated, the little fruit sits there, gradually shrivels and then falls off. Cucumbers may turn yellow and fall off, but if only partially pollinated will develop shrunken ends.

Hand pollinating is one answer. In the case of squash, take the male blossoms (they don't have a small fruit at the base of the flower), tear off the petals and dab some pollen on the female flowers. With cucumbers, the flowers are smaller and you may find it more convenient to use a small brush to hand pollinate them.

Mildred Habib of Corpus Christi has been visiting her sisters, Ruth Griffith and Elaine Gulley, and her brother, Cotton Smith.

In a kitchen emergency, you can substitute a tablespoon of flour for a teaspoon and a half of cornstarch.

Outreach Service Planned For Victims Of Family Violence

Area women who have not had access to specialized help in coping with family violence will be able to receive that help in the near future through the Noah project of Abilene.

The situation is common. A family disturbance gets out of hand and ends in physical abuse. Many times - an estimated 65,000 times in Texas - the wife receives the brunt of the violent attack.

Across the state, dozens of outreach programs and shelters for battered women are springing up in an effort to provide abused women with counseling and protection. The Noah Project has seen much progress in the past few years. Like its namesake, Noah began with a small group of people, but armed with limited funds and unlimited determination, the Noah supporters have watched their program grow into a successful organization complete with a board of directors, volunteers, staff and community support.

There has been no outreach program of this nature in our immediate vicinity. However, over a four-month period, there were over 20 referrals of battered women and children from the Haskell, Knox, Throckmorton and Stonewall County area to the Abilene Shelter. Many victims of family violence are reported each year to the Central Texas Mental Health-Mental Retardation Center and to other local human service agencies. Because studies indicate that this statistic represents only a small portion of the women abused in this area, Noah Project workers see a definite need for an outreach program in the area.

Plans are now underway for a local outreach service, according to Betsy Nanny of Haskell, Noah Project's outreach coordinator. She said two core groups of area citizens are needed to plan the community-based program - an advisory committee of men and women in Haskell, Knox, Stonewall and Throckmorton counties and a group of volunteers to carry out the services. The target date for the intro-

duction of the local outreach service is on or before September 1.

Statistics surrounding the subject of battered women are startling. Reports indicate that 16 out of 100 couples in the U.S. experience one or more violent incidents each year. A recent survey showed that as many as half the women who marry in any given year will be beaten by their husbands some time during their marriage.

The average victim of this type of physical abuse is a far cry from the stereotype of the battered wife. According to studies, most of the women who seek help from public funded shelters like the Noah Project are Anglo, and only ten percent receive any type of welfare assistance. The average victim is 25 years old, does not abuse alcohol or drugs, has a high school education and two children and does not work outside the home. Most have been beaten several times off and on for a period of at least a year and have stayed in the violent situation primarily because of economic dependence.

The 70 Texas centers for battered women provided food, shelter and counseling to almost 12,000 women and children last year but were unable to assist nearly 17,000 others because of the lack of funding and space. In 1983, the Abilene shelter helped 222 people, but was forced to turn away another 150.

A state attorney who visited Abilene's Noah Project has called on the federal government to earmark funds for programs aimed at eliminating family violence. The Noah Project shelter is funded by the Criminal Justice Department, the State Department of Human Services and by private contributions. The center receives approximately 60 percent of its funding from groups and individuals in the Abilene area and about 40 percent from the state.

A call to the local crisis hotline, which will probably be located in Haskell, will result in a trained volunteer being sent to a safe site to meet with the battered woman. At all times the outreach service will work hand in hand with local law officials. The volunteer will make an assessment of the case based on the severity of the battering and will decide whether or not it is safe for the woman to return to her home. If the volunteer determines that it would be dangerous for the woman

to return home, transportation to Noah or one of the other state shelters will be provided or the woman will be taken to a safe place at no cost to her. Her whereabouts will remain completely confidential.

Whether the client is placed in a temporary residence or is returned to her home, she will be offered professional counseling. The counselors will map out the various options available to her, and in cases where needed, help find housing and jobs and assist her in signing up for any government aid programs for which she might be eligible.

"We're not out to break up the family," stressed Mrs. Nanny. "We just try to present these women with the options. The client makes her own decisions."

Volunteers are needed to help

serve on the outreach advisory committee or to learn to assess and counsel battered women in this area. Interested persons should contact Mrs. Nanny at 817-864-2551 or 864-3972 or the Haskell County Sheriff's Department at 864-2345.

A bass tournament sponsored by Skinny's and Conoco of Abilene will benefit the Noah project. Fish may be caught at any public lake and weighed at the parking lot of Westgate Towne Centre in Abilene. The tourney will be held Saturday, June 27, and entries must be received at any Skinny's location by midnight June 26. Entry fee is \$40 and \$7,600 in prizes is guaranteed. Fish must be caught between 6 a.m. and 3 p.m. that day to be eligible, and must be weighed in from 2 to 6 p.m.

- Automobile • Homeowners • Farm Policies
- Medicare Supplements • Major Medical
- Universal • Life • Hospital-Medical
- Accident • Disability • Group • Pension
- Annuities

And many other types of Insurance

WALLACE MOORHOUSE INSURANCE
P.O. Drawer 9 Munday, Texas 76371
Phone 422-4341
"Writing Insurance Since 1943"

For: Father's Day

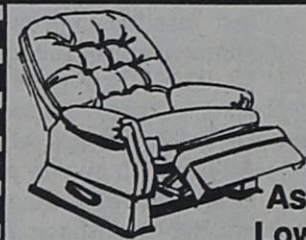

All Recliners ON SALE!

As Low As \$169⁰⁰ WT

We Want To Be Your Furniture Store!

Boggs & Johnson

East Side of Square Haskell (817) 864-2346

Saturday Benefit To Aid Farm Hotline

A benefit concert and dance to help finance the Texas Farm Crisis Hotline will be held from noon until midnight Saturday, June 20, at the Wichita Mounted Patrol Arena on Farm Road 369. Sponsors will be the Texas Department of Agriculture, radio station KLUR FM and the Wichita County Mounted Patrol.

Deputy State Agriculture Commissioners Mike Moeller and Nancille Gallimore, executive director of the farm crisis hotline, will be on hand for the benefit, according to Ronald Bertrand of Vernon, district supervisor of the Department of Agriculture.

Several North Texas area bands including some familiar names from Wichita Falls are scheduled to play during the benefit. A barbecue dinner featuring Texas beef, buffalo and goat will be prepared by the Red River Renegades and served from 6 to 8 p.m. Among those donating food for the meal is Munday vegetable producer Larry Smith.

Tickets for the concert and dance are \$5 each, and the meal costs another \$3. More information about the function is available by calling 817-552-9954 or 817-322-7170.

Founded 18 months ago, the Texas Farm Crisis Hotline has served more than 10,000 farmers and averages about 200 callers a month. Most frequent concerns of the callers include problems with the U.S. Farmers Home Administration, operating loans, bankruptcy, foreclosure and miscellaneous legal questions.

Calvin Gambill

B.A., D.C.

Chiropractor

711 West California

Seymour, Texas 76380

Area Code (817) 888-3412

U STORE IT
U LOCK IT
U KEEP KEY

THE JEWEL BOX
MINI-WAREHOUSE
422-4722

We've Moved

To A New Location

(550 South Second - Formerly The Porthole)

Enlarged For Your Convenience!

More Seating - More Parking - Expanded Menu

New Items: Salad Bar

Chicken Fried Steak

Fried Chicken

Still Featuring Our Delicious

Bar-B-Que Daily

Beef - Chopped Beef - Homemade German

Sausage, Ribs - Ham

Ribeye Steaks and Hamburgers

Cooked Over Mesquite Coals

Available After 5 p.m.

Dine In or Take Out

Catering and Custom Cooking Available

Hours 11 a.m. - 9 p.m. Monday thru Saturday

(Closed Sundays)



GLENN'S
Bar-B-Que EXPRESS

Haskell

PH. 817-864-8116

This Month Alan D. Myers, Jr. Becomes The Chairman Of The Texas Savings & Loan League.

We Are Proud That For Many Years He Has Been Our Friend And Business Associate.

He Belongs Among The Thrift Industry's Most Honored Ranks.

Congratulations Al, From All Your Friends At

The Munday Courier
422-4314

CLASSIFIEDS

INEXPENSIVE
PROFITABLE

★ Weinert News ★

By Mrs. Myrtle Pheemister

★ For Sale

BANK REPOS: 1981 Magnolia 26x60 double-wide mobile home. Central heat and air with refrigerator, cook stove and dish washer. 1400 sq. ft. Excellent buy at \$9,000. Call 658-3527, ask for Wayne.

7-tfc

3-YEAR OLD MOBILE HOME FOR SALE: 3 bedroom, 2 bath, central heat and air. Real nice. Call 8-5, 422-4547, after 5, 422-5354.

26-tfc

PIANO FOR SALE: Assume small payments on modern style piano, like new condition. Can be seen locally. Please call. Manager, 1-800-367-3140.

36-3tp

FOR SALE: Registered Angus bull calves, reasonable prices. Bob McWhorter, 422-4980.

33-tfc

FOR SALE: 14x80 mobile home, 3 bedroom, 2 bath, good condition, appliances. Call 422-4269 after 5 p.m.

36-tfc

FOR SALE: 7-piece bedroom suite, queen size waterbed. Good condition. Will sell separately or all together. Call Melanie Wood, 673-8222 or 673-8283.

38-3tc

FOR SALE: GE 14,000 BTU refrigerated air conditioner. Call 422-4353.

38-tfc

FOR SALE: Small Welsh pony, with or without child's saddle. Reasonable. Call 864-2978 or 422-4389 after 6 p.m.

38-1tp

FOR SALE: 50 lb. bags of sweet onions, \$13 per bag. James Smith farm 4 miles east of Munday or TXS Vegetable Shed.

38-2tc

FOR SALE: Tropical Snow. Easily moved. Includes air conditioned building, machine and all supplies. Call 658-3086.

38-tfc

CARD OF THANKS

Thank you for all the prayers, cards, flowers, food, phone calls and visits during my stay in the hospital and after my return home. Words cannot express what friends mean to me at this time in my life.

May God bless each and everyone of you.

Lucille A. Smith

FOR SALE: Several good farms mostly owner financed. Some irrigated, some dry. Now is the time to invest in good farmland.

IN MUNDAY: 2 bedroom, living room, kitchen and bath. A bargain. 338 S. 12th. **FOR SALE:** 1 bedroom, living room, kitchen, bath, situated on 2 acres, with Ford tractor. A bargain. Sun-set.

VERY NICE 3 bedroom, 2 bath, 14x80 mobile home with fireplace, 1988 Sun Villa. Owner financed after down payment. low interest. Will accept reasonable offer.

Give Us A Call

Counts Real Estate
Phone 658-3390 Knox City

★ Misc.

BULK CATTLE FEED and hog feed manufactured and delivered by Baylor Milling Co., Seymour. Ph. 888-5595. After 6:00 p.m. call 888-2683.

tfc

LICENSED WATER WELL DRILLER: Drilling house, stock, irrigation wells and test holes. Call W.P. Hise, 864-3727, Haskell, Texas (day or night)

tfc

SEPTIC TANKS pumped out! Call Roe Allred, collect, Munday, Texas.

tfc

GONZALES CONSTRUCTION: Nefro Gonzales, contractor. Building, remodeling, repairs, roofing, concrete, painting. Free estimates. Also complete line of Alsteel building products including steel siding. Call 817-658-3732, Knox City.

29-tfc

RENT A VCR from the Video Station in Munday. Daily VCR rentals are \$5.00 plus one movie free; weekend rentals (Friday, Saturday, Sunday) \$10.00 and one movie free; weekly rentals are \$20.00 and two movies free. Call 422-4867.

34-tfc

OWN YOUR OWN APPAREL or shoe store, choose from: jean/sportswear, ladies apparel, mens, children/maternity, large sizes, petite, dancewear/aerobic, bridal, lingerie or accessories store. Add color analysis. Brands: Liz Claiborne, Gasoline, Healthtex, Levi, Lee, Camp Beverly Hills, St. Michele, Chaus, Outback Red, Genesis, Forezza, Organically Grown, over 2,000 others. Or \$13.99 one price designer, multi-tier pricing discount or family shoe store. Retail prices unbelievable for quality shoes normally priced from \$19.00 top \$80.00 Over 250 brands, 2600 styles. \$14,800 to \$26,900; inventory, training, fixtures, grand opening, airfare, etc. Can open 15 days. Mr. Loughlin, (612) 888-6555.

38-1tp

OWN YOUR OWN beautiful discount shoe store. Offering over 300 top designer name brands and over 1500 styles at unbelievable retail prices of \$6.75 and up. All first quality merchandise. Satisfaction guaranteed. Andrew Geller, Evan Picone, Naturalizer, Stride Rite, Bandolino, Reebok, Amalfi, 9 West, Gloria Vanderbilt and many more. Handbags and accessories also. \$16,900 to \$39,900 includes beginning inventory, training and fixtures. Call anytime. Prestige Fashions, 1-800-247-9127.

38-1tp

MISSING: Red 10-speed bicycle, left at Pony League field. If found contact Chris Scott at Patterson Apts., 422-4949.

38-1tp

WANTED: YARDS TO MOW. 4 years experience. Call Michael Waggoner, 422-4353.

33-tfc



Windshields, Wheel Aligning
Frame Straightening
Painting, Door Glass
24-Hour Wrecker Service

LEWIS PAINT & BODY SHOP
Sterling Lewis, Owner Knox City
Telephone 658-3342
Nights Dial 658-3330

★ Real Estate

FOR SALE: Four bedroom brick home and 12 acres. One mile from Munday, city water. Call First National Bank in Munday, TX.

52-tfc

NEGOTIABLE: 2 bedroom brick home, one acre, 1/4 bath, patio, pecan trees, cellar, city services, water well.

33-8tp

HOUSE FOR SALE: Two bedroom, one bath, nice size living room, kitchen, utility room with connections for washer and dryer, single carport. Located on two lots with plenty of shade trees. 420 North 3rd, phone 817-422-4442.

35-5tp

FOR SALE: 160 acre farm approximately 3 miles north of Munday. Call Bob McWhorter or Gary Schur, 422-4522.

37-tfc

HOUSE FOR SALE: On 2 acres 1 1/2 miles east of Munday. 2 bedrooms, 2 baths, den, central heat and air, ceiling fans, built-ins, screened in porch, double garage, cellar, pecan trees. Call 422-4525 or 422-5148 after 5 p.m.

38-tfc

★ Garage Sales

GARAGE SALE: Western Motel, Friday, 9-7 only. Mattress sets, double, \$45 each; single, \$30 each; pillows, 75¢ each; heavy duty curtains, \$1; good cassette player with radio, \$35; dust-buster, dinette with 6 chairs, velvet bedspreads.

38-1tc

GIANT 5 FAMILY Garage Sale: Saturday, 8-4. Lawn mower, baby furniture, electric grill, platform rocker, recliner, dishes, men, women and children's clothes all sizes. Cindy Guess, Caron Yates, Dorothy Brown, Sarah Guess, Alice Yates. 210 S. 4th. No early sales.

38-1tp

YARD SALE: Saturday, 8-6. 441 S. 9th. Trundle bed, chest of drawers, bedding, small appliances, stereo, much more.

38-1tc

GARAGE SALE: Thursday, Friday, 8-5. Clothes, toys, shoes, etc. 841 S. 7th.

38-1tc

★ Wanted

TAKING APPLICATIONS for truck driver. Must have commercial license and good driving record. Apply in person at General Shelters, Munday. 37-3tc

IF YOU NEED TYPING done, contact Mrs. Carolyn J. Welch, 422-5357.

33-20tp

**Haircut
Perm
Hair Set**

Call 422-4622

Jo's Beauty Shop
Munday, TX

B-K Electric Cooperative, Inc.
NOTICE OF NOMINATING COMMITTEE MEETING

In accordance with the provisions of the bylaws of the Cooperative, the Board of Directors has appointed a Committee on Nominations as follows:

Frankie Portwood, Rt. 3, Box 103, Seymour, Texas 76380
William B. Mills, Rt. 3, Box 89, Seymour, Texas 76380
Louis Jakubcek, Rt. 3, Box 67, Seymour, Texas 76380
John Crownover, Box 636, Knox City, Texas 79529
John L. Grindstaff, Jr., Box 363, Knox City, Texas 79529
Mrs. Sydney Alexander, Box 758, Truscott, Texas 79260

The Committee on Nominations will meet June 19th, 1987 at 2:00 p.m. at the Seymour Office of B-K Electric Cooperative, Inc. to make nominations for directors.

The Directors' terms expiring are Charles T. Porter, Seymour and James Albus, Knox City.

Members of the Cooperative are hereby notified of this meeting.

PUBLIC NOTICES

BECAUSE THE PEOPLE MUST KNOW

NOTICE TO BANKS OF KNOX COUNTY

The Goree Independent School District school board will accept bids for designation of Goree School District deposits until 7 p.m. July 7, 1987. Any banking concern within the county desiring appointment as depository bank will file their bid application with the superintendent's office by 7 p.m. July 7, 1987.

Leroy Russell, President
Goree ISD School Board

38-1tc
40-1tc

PUBLIC NOTICE

Knox County Commissioners Court will convene in a public hearing on Friday, June 26, 1987, at 9 a.m. in the Commissioners Courtroom, Knox County Courthouse, Benjamin, Texas, for a general discussion of the proposed Knox County Budget for the fiscal year October 1, 1987 to September 30, 1988.

All interested citizens of the county may give written/or oral comments.

David N. Perdue
Knox County Judge

38-1tc

Local Lady Enjoys Visit With Family

Mrs. Lala Morgan of Munday has had a busy few weeks, entertaining several visitors in her home and then taking a trip herself. She took a few minutes from her schedule to share part of her travel itinerary with us.

Visitors in Mrs. Morgan's home in late May were Neva Biggs and sons, Scott and William, of Austin, Otis Spann, Gerald and Gayle Morgan and children, Elaine Reese and Jayson and Tony Morgan, all of Munday. The group attended Munday High School graduation exercises.

After visiting their aunt and uncle, Ursel and Nolan Phillips, Mrs. Biggs and sons returned home, taking Mrs. Morgan along. During the week in Austin, Mrs. Morgan's sons, Nolan and Dennis, and their wives visited in the Biggs home and the ladies did some shopping. She enjoyed a movie and spent one night with Nolan and Martha Morgan and attended two church services with her daughter.

Before she left Austin, Mrs. Morgan was the guest of honor at a family supper featuring fresh garden vegetables and homemade ice cream. Those attending were the Biggs family, Nolan and Martha Morgan, Dennis and Judy Morgan and their son, Kent and his wife, in addition to two of William Biggs' friends. The group spent a happy evening visiting and looking at old pictures, while also taking some new photographs.

Neva Biggs celebrated her birthday on June 8, so Mrs. Morgan made her a cake and stayed for a special birthday supper, then returned home on the bus the next day. She reported a very enjoyable stay in Austin, even though it rained nearly every day!

Community Calendar

June 18 - Chamber of Commerce.
June 22 - Fire Department.
June 23 - Lions Club; Pest Identification Workshop.

The Weinert Community offers its sympathy to the Rich family, former long-time residents here, as we mourn the passing of Jack Rich, who was interred in Willow Cemetery at Haskell on June 13. Jack and his family have resided in California for many years.

Our sympathy is extended to Tom Kreger and to the rest of the Kreger family at the sudden death of Melvin Kreger. The Kreger family are also long-time residents of the Weinert community. Melvin's memorial service was held at the Church of Christ on Tuesday, June 16, at 10:30 a.m. and he was buried in the Pleasant Valley Cemetery east of town. Mr. and Mrs. Kreger moved to Haskell a few years ago when he retired from farming.

Eddie and Myrnie Sanders spent some time in Wichita Falls last week. Myrnie's brother, Johnnie Johnson, and his new wife of California, are here for a week's visit with relatives.

Pamela and Tim Marshall and Sarah of Weatherford, Oklahoma were in town to visit her grandmother, Francis Mahan, and attend worship services at the Church of Christ on Wednesday. Pamela is a student at a pharmacy school and will follow in the footsteps of her parents, Margie and Pete Jordan, who are both pharmacists at their own drug store in Hamilton, Texas. Tim is a coach and also preaches part time.

Debbie Hutchinson is at home for the summer and will be working at M-System in Haskell.

Sallie Sanders was in Ft. Worth for a reunion of her family tree the past weekend. They met at the home of Marie and B.D. Kirkland and approximately 100 of her descendants of five generations were present for the activities.

Sallie and her daughters left on Sunday afternoon for a tour of Arkansas, destination Eureka Springs, where they spent a delightful week last year. Looks like it might become an annual trek!

Bob Raynes was the honoree at the reunion of the Bob and Crystella Raynes' family held on June 13 and 14. All the children, grandchildren and great-grandchildren gathered at the Bobby Raynes' cabin on Lake Stamford to honor Bob on his birthday and to celebrate an early Father's Day.

There were 35 descendants and six visitors present for the festivities of boating, fishing, visiting and of course, eating.

Joe Yates was honored on his 35th birthday when his family and friends gathered at his home for dinner on Thursday night, June 11.

David Pheemister celebrated his 46th birthday at a party in his parents home on June 11. Those from out-of-town included a sister, Lola Williams of Harlingen, nieces, Jenny Pollostro and Emily of Phoenix, Arizona, nephews, Robert Tipton of Ft. Worth, Mr. and Mrs. Randy Pheemister and Dacia, Joseph, Desha and Jeffrey, and Ricky Pheemister, all of Haskell. Charlotte Futrel of Florence was a special guest also.

Marilyn and Johnny Earp were in Abilene to visit her mother, Francis

Smith, who was hospitalized there. She has been dismissed, and is at home now in Goree.

Visitors at the First Baptist Church on Sunday were Ann Ogle and daughter, Martha, of Kansas who are here with a harvesting crew.

Visitors in the home of Raymond and Bernice Mathison were her sisters, Elva and John Rich and daughter Belinda, of Ingleswood, Calif., and Lucille Wickson of Brownwood. Carrie Mae Rich Brown of Reseda, Calif. was also a visitor. They were here to attend the memorial service for Jack Rich.

Kelly Watkins returned home to Garland with her parents for the summer months. She is enrolled in college for morning classes, but will return in September to finish her senior high school work in Weinert. While she is away her grandmother, Thelma Edwards, is working at Lane-Felkers in Haskell.

The Jerry Walkers are entertaining their two grandsons this week, Justin and Rance Parrot of Wichita Falls, children of Cindy and Stacy Parrot. The Parrots were here Friday to visit Cindy's parents, Deena and Barry.

Mr. and Mrs. Mark Coffman and sons will be in Austin this weekend where Mark will help with coaching duties at the University of Texas basketball camp.

The Coffmans were in Bridgeport this week as they looked for a house to rent. They will be moving to a coaching position in the Bridgeport school in the near future. We regret their leaving Weinert, but we are pleased he has been offered the better job.

Our Little League ball team finished their fourth week of competition as they played at Munday on Tuesday night. They look forward to two more weeks of baseball.

COMING EVENTS:
Descendants of the late Jim and Ophelia Alexander will gather for their annual family reunion to be held June 19 and 20 at the Kiva Inn in Abilene. Mr. and Mrs. Larry Caddell of Springtown are planning the event, and will be in charge.

Mrs. Sandy Lampert of Stamford will be guest speaker at the June 25 meeting of the WMU of the First Baptist Church. The meeting will be at 7 p.m., and ladies in the area are invited to attend the fellowship meeting.

Mrs. Lampert has been a missionary in Argentina, and will base her speech about missionary work. Her husband is pastor of the First Baptist Church in Stamford.

Francis Mahan will leave Saturday for a trip to Mesa, Arizona, to be with her son, Billie Allen, who is having heart problems and may require surgery.

Leonard Mahan Jr. will undergo surgery in Abilene on June 23 to correct an injury to his arm that causes his arm to be displaced easily.

Our birthday people this week are Bernie Kimmel, Mabel Derr, Francisco Diaz, Shelia Castorena and Rene Vojkufka. Happy Birthday!

These couples are observing anniversaries: Ricky and Karen Harlan, Mark and Kim Stewart and Gilbert and Sophia Jimenez. Best wishes to each one!

MANY THANKS

to the sponsors of the Munday Chamber of Commerce First Annual Bass Tournament.

- | | |
|-------------------------------|--------------------------------|
| Stewarts Texaco | Vita Auto Parts |
| Charles Baker Insurance | And Fishing Tackle, Seymour |
| City Hardware, Knox City | Ralph's Auto Service |
| Clonts Hardware, Knox City | K-Mart of Abilene, North First |
| The Fair Store | Bill and Johnnie Smith |
| Farm Bureau, Don Welch | R. J. and Jeanie Duncan |
| First National Bank in Munday | Raymond and Bea Carden |
| Home Building Center | Doris and Ernestine Dickerson |
| T-Shirts Too | Ralph and Francis Cypert |
| Jo's Beauty Shop | Earlene Kuehler |
| John Lee Wilde | Maxine Wilde |
| Knox County Abstract Co. | Debbie Harlan |
| The Munday Courier | Jan Zeissel |
| M-System | Jo Heard |
| Munday Tire and Appliance | Randy Bob Cypert |
| Osbornes | Ray Lynn and Joyce Hardin |
| Penman Bass Pro Shop | Bobby Burnett |
| P & M Supply | Frank Dutton |
| Reid's Hardware | Fire Department Auxiliary |
| Smith Drug and Gift | Norman Anderson |
| M.L. Wiggins | Ronnie Adams |
| Munday Auto Supply | Lee Buchanan |
| Ralph Cypert | |

Jurecek and Manly Marine, Seymour

Also, to all those who entered, worked, attended, served or provided food, and to the skiers who waited for the tournament to end before getting on the lake! A job well done for the Munday community!

Munday Chamber of Commerce
Kay Looney, Manager and Directors

FOR THE BEST CAR DEAL

See
John Phillips, salesman
for Bailey-Toliver
Chevrolet-Oldsmobile



Phone 422-4037 Munday, TX

For All Your Aerial Application Needs,
Call Edd Lane at
D & H
Aerial Spraying, Inc.
MUNDAY AIRPORT MUNDAY, TEXAS 76371



Edd Lane
Pilot & Manager
Telephone
817-422-5308

M SYSTEM

Your FRIENDLY

AFFILIATED SUPER MARKETS MUNDAY, TEXAS

Monday - Friday, 8 a.m. - 7:30 p.m.
Saturday, 8 a.m. - 8 p.m.

DOUBLE COUPONS TUESDAY and WEDNESDAY

We will redeem all manufacturer cents off coupons for double their value up to \$1.00 in value when the product is purchased. Limit one coupon per item. This policy does not include retailers, food stores, free coupons, cigarette or tobacco coupons or refund certificates. The total redemption will not exceed the value of the item.

We Gladly Accept Food Stamps

Prices Good
June 18-19-20, 1987
We Reserve The Right To Limit Quantities.

W.I.C.



QUALIFIED

KINGSFORD

CHARCOAL

\$2⁶⁹

Briquets, 10-Lb. Bag

Classic Delight
Ice Cream

\$1⁹⁹

HALF GALLON CARTON

Limit 2 With \$10.00 or More Grocery Purchase

Roman Meal
BREAD
1/2 lb. Loaf
89¢

Thompson
White Seedless or Flame Red

Grapes

MIX OR MATCH!
LB.

69¢

- RED PLUMS Calif. Large Lb. 69¢
- FRESH CANTALOUPE Lb. 39¢
- FRESH CARROTS 2-Lb. Bag 59¢
- FANCY BELL PEPPERS Each 3/1.00
- FRESH BROCCOLI Bunch 99¢
- FRESH GREEN CABBAGE Lb. 25¢
- YELLOW ONIONS 3 Lbs. 1.00
- SALAD TOMATOES Red Ripe Lb. 59¢

PRICE SAVER
BACON

1-LB. PKG. **88¢**

Limit 2 With \$10.00 or More Grocery Purchase



COUNTYLINE LONGHORN
CHEESE

Halfmoon
Colby or Cheddar

10-oz. Pkg.

99¢

Limit 3 With \$10.00 or More Grocery Purchase

IMPERIAL
SUGAR

5-LB. BAG **\$1⁶⁹**

RANCH STYLE
BEANS

3 15-oz. CANS **\$1⁰⁰**

LIP-ON

RIBEYE STEAKS.....Lb. **3.79**

SHEDD SPREAD

Country Crock.....3-Lb. Tub **1.69**

LEAN MEATY PORK

SPARERIBSLb. **1.85**

KRAFT American-Swiss-Pimento

CHEESE SINGLES....12-oz. **1.69**

DELTA PAPER
TOWELS
JUMBO ROLL

49¢

Angel Soft Toilet

TISSUE

WHITE-PASTEL-PRINTS
4-ROLL PACK

99¢

MORTON FROZEN
Dinners

10 to 11-oz. PKG.

89¢

FOLGER'S
COFFEE

ALL GRINDS

1-LB. BAG

\$1⁸⁹

KRAFT SALAD
Dressing

ASST. KINDS
8-oz. Bottle

79¢

Cream Pies Pet Ritz 14-oz. Pkg. **89¢**

Solo Party Cups 16-oz. Size, 20-Ct. **99¢**

Solo Party Plates 9" Size, 15-Ct. **99¢**

Pouch Mixes Gladiola Asst. 6-oz. **4/1.00**

Purex Bleach Gallon Jug **79¢**

KRAFT
MACARONI & CHEESE DINNERS

3 7.25-oz. BOXES **\$1⁰⁰**

Limit 3 With \$10.00 or More Grocery Purchase



COKE
(ALL VARIETIES)

12-oz. CANS
6-PACK **\$1⁴⁹**