

The Ozona Stockman

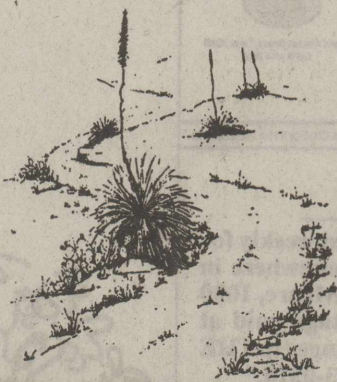

3000 SQUARE MILES
OF
CROCKETT COUNTY
LIVESTOCK TERRITORY



Crockett Co. Public Library
Box 3030
Ozona, Texas 76943

40¢

Crockett County's
News Source

"Out In The West, Where The Air Is Pure, The Climate Agreeable, And The People Friendly -- The Best Place On Earth To Call Home."

Ozona, Crockett County, Texas 76943

USPS 4168-2000

Wednesday, September 14, 1994

Volume 81

Number 31

Lions Host Sanderson For Homecoming Game

Homecoming 1994 on Sept. 16 will see the Lions hosting the Sanderson Eagles at 8 p.m. in Lion Stadium. Pre-game activities begin at 7:35 with the crowning of the Football Queen.

Candidates this year are: Leigh Chandler, Hope Flores, Gloria Peña-Alfaro and JoLynn Vannoy.

Leigh is the daughter of Mr. and Mrs. Erby Chandler. She has been a varsity cheerleader as a junior and senior and will have played basketball throughout high school and been a member of the band.

A four-year member of the Student Council, she was secretary her sophomore and junior years and treasurer this year. Leigh was a member of the regional qualifying one act play last year and was selected class favorite as a junior. 4-H activities have included showing sheep.

Escorting Leigh will be Matthew Ortiz, son of Lucy Ortiz and Jose Flores. Matthew is a four-year member of the OHS football team and played basketball as a sophomore. He is a member of the Catholic Church.

Candidate Hope Flores is the daughter of Lucy Ortiz and Jose Flores. She was a Lion cheerleader her sophomore and junior years, played basketball as a sophomore and ran track as a freshman and sophomore.

Hope was named Class Favorite her freshman and sophomore years.

J. J. Lozano, grandson of Mr. and Mrs. George C. Ybarra, will escort Hope.

J. J. has been active in high school athletics, playing football four years, basketball as a sophomore, baseball as a sophomore and junior and running track for three years. He was a member of the cross country team last year and president of his class. J. J. is a member of the Catholic Church.

Gloria Peña-Alfaro is the daughter of Ruben Penna-Alfaro and Oscar and Tommie Flores.

She is a four-year member of the Ozona basketball program and has been captain for the Ozona Lady Lions her junior and senior years.

Gloria has been a member of the National Honor Society since her sophomore year and was elected sophomore and junior class representative. She is a cheerleader this year and attends the Catholic Church.

Chris Sanchez, son of Richard and Fannie Sanchez, will escort Gloria. He is a four-year member of the Lion football team, serving as captain this year. He also participated in basketball, track and baseball. He is a member of Who's Who in Sports.

Chris served as freshman class vice-president, sophomore class president and junior and senior Student Council class representative. He is a

member of the Catholic Church.

JoLynn Vannoy is the daughter of Dr. and Mrs. Gary Vannoy. She has served as secretary of the National Honor Society, is a cheerleader and band member, student athletic trainer, qualified for regional in UIL poetry and one act play and competed in persuasive speaking. She is senior class representative to the student Council.

She is a 4-H District Council officer and former Texas 4-H Council member. She attends Ozona Church of Christ.

Travis Davidson will escort JoLynn. He is the son of Mr. and Mrs. C. E. Davidson IV.

He is a four-year member of the Lion football team and as a junior was regional champion and state qualifier in power lifting. Travis is president of the National Honor Society this year and was class vice-president as a sophomore.

Leading up to homecoming activities will be the annual bonfire Thursday night and an afternoon pep rally Friday. The bonfire will be at 8 p.m. Sept. 15 near the baseball complex north of town. The pep rally is scheduled to begin at 3:45 Friday afternoon in front of Davidson Gym.

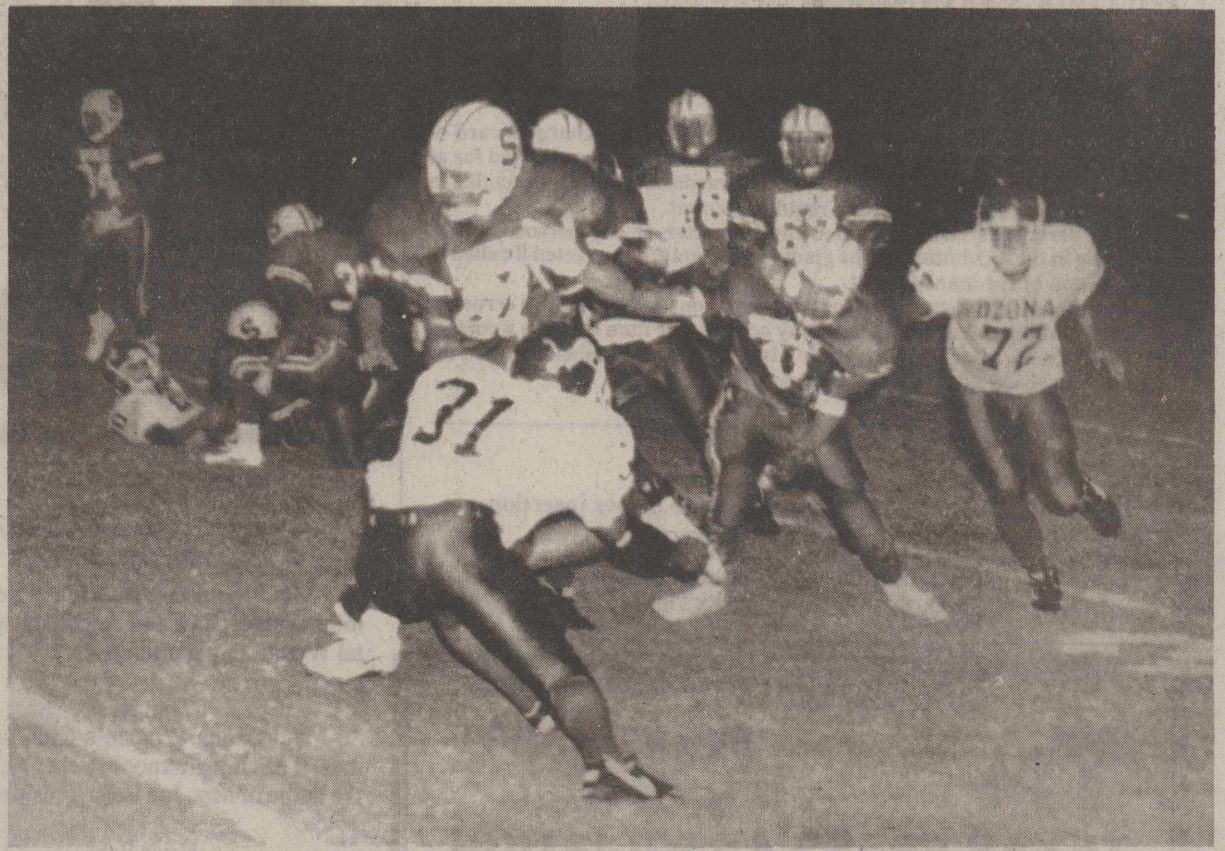

OZONA LION #31 JOE ESPARZA tackles a Sonora player as #72, Patrick Sanchez, comes to help out. Sonora defeated Ozona 26-22 in a non-district game in Sonora. Photo by Neal Ulmer

Lions Come Up Short In 26-22 Heartbreaker

By Neal Ulmer
Stockman Sportswriter

A strange chain of events and turnovers led to a 26-22 Ozona Lion loss to the Sonora Broncos in last Friday's game in Sonora. Ozona fans overflowed the visitors' side and watched in awe as the game seasawed back and forth.

David Browne stepped in for the injured Chris Sanchez at quarterback and quickly got into the groove by scrambling and passing throughout the night, particularly to wide receiver Jesse Garza, who was Browne's prime target for the evening.

Browne connected with Garza in the first quarter on passes of 12, 10, 14 and 17 yards. The last reception resulted in a touchdown with 4:21 left in that quarter. A fumble on a try for the extra-point kick turned into a two-point conversion when holder Jesse Garza picked the ball up and ran around left end. The Lions led with the score Ozona 8, Sonora 0.

Running back Matthew Ortiz picked up a total of 71 yards in the first half of play, garnering 54 yards in six plays. This included one jaunt of 34 yards to add Ozona's second touchdown of the game. Fellow teammate and senior Anthony Sanchez carried only three times and substituted for Chris Sanchez in the secondary.

Ozona gained their next score on a 15-yard pass from Browne to Garza in the early moments of the second period. The extra point was kicked by Bryan Mendez to make the score Ozona 15, Sonora 0.

Ozona's defense held the Broncos for a third time, forcing them to punt. The Lions' troubles began toward the end of the second quarter, when the ball was hiked over punter Joe Esparza's head. Esparza was unable to kick, but managed to retrieve the ball and take it five yards upfield to the 28-yard line.

Sonora took over the ball, and four plays later reached the end zone on Davis Hale's 21-yard pass from Jason Morely. A two-point conversion try failed, and the Broncos cut the lead to Ozona 15, Sonora 6.

Julio Martinez returned the ensuing kickoff to his own 42-yard line before being stopped. Through the running of Browne and Ortiz, the ball was brought down to the Sonora 45-yard line. A Browne pass was intercepted by Sonora's Levi Pool and returned to the Ozona 25-yard line.

With a Sonora penalty and a 25-yard run the Broncos were forced by Ozona's defense to attempt a 25-yard field goal. The try failed, and the Lions took over the ball, to continue their lead at halftime 15-6.

With a sore ankle, Chris Sanchez entered the game in the defensive secondary to help with added coverage. Sanchez ended a Sonora scoring drive when he intercepted a Morley pass on the Lion 20-yard line.

Two plays later Garza fumbled a pass reception, and the Broncos re-

covered on the 22-yard line. Taking advantage of the turnover, the Broncos scored seven plays later on a hard plunge at the beginning of the fourth quarter to begin dominating the game. A kick for the extra point was good, and Sonora extended their lead to 13 points, thus Ozona led by two points - 15-13.

Receiving good field position on the Broncos' 47-yard line, Lion David Browne tried a quick pitch left which was intercepted by Sonora's Gabriel Perez and returned 46 yards for a touchdown. The extra point was good, and Sonora took the lead for the first time with a score of 20-15.

Ozona fought back with a drive starting on their own 29-yard line. Passes of 6, 29, and a 36 yard touchdown to Garza made it 21-20, and the extra point by Mendez gave the Lions a two point lead with the score 22-20.

The Ozona defense stopped the next Bronco drive and gave the ball back to their offensive team. The Lions received the ball on Sonora's 45-yard line. Two plays later Browne's pass was intercepted on the 19-yard line. On the next play Sonora fumbled, Ozona recovered, then Ozona fumbled

(Continued on pg. 6)

Lower Taxes Fund Bigger Budget

Commissioners approved a 1995 budget of \$6,766,716 at their meeting Sept. 12. The budget, up from \$6,481,256 for 1994, is to be funded by a tax rate of .683 per \$100 valuation, down from the .73868 tax rate which funded 1994.

The school tax rate, which is to be voted on Sept. 20, will be \$1.230 per \$100 valuation compared to \$1.21 for current funding.

Emerald Underground Water District's tax rate will decrease from .020 per \$100 valuation to .016.

Total tax rates for the three entities for 1995 budgets are \$1,929 compared to \$1,968 for 1994 a decrease of .03968 overall.

During a report by Gerry Phillips, administrator of the hospital and care center, commissioners learned that there have been no workman's comp losses shown by the insurer as of June 30, 1994. Phillips was commended by the court for this outstanding record.

A change in the financing plan for county employees was discussed, but no action taken. The county's retirement plan, which is under the Texas County and District Retirement System, is not adequate for long-term according to a valuation by a consulting firm. The county has three options for change to the current financing arrangement.

The benefit formula can be changed. Keep the formula the same and increase the county's share of retirement funding from 8% to 9.2%,

or decrease the formula and have the county contribute 8.1% to the retirement plan. Employees contribute 7% to the retirement plan.

Commissioners had a two to two tie vote on approving the third option, which would reduce benefits by 15% on earnings after 1994. They will make a decision on plan changes after obtaining additional information.

As part of the retirement discussion, commissioners agreed to leave the vesting period for retirement at 12 years.

Larry Williams, John Williams and Martha Mayfield of Williams Enterprises appeared before the court to request that mineral rights under various lots and streets belonging to the county be put up for bid. Williams Enterprises addressed school trustees on the same subject earlier and was to be on the board's agenda Tuesday night. Commissioners tabled action on the request until their next meeting.

The court did approve a resolution presented by Larry Williams endorsing an effort to form a community-wide foundation. The foundation, with a board from all aspects of the community, would solicit money (grants, donations, etc.) in the name of the community. These funds would be put into the foundation, and the board would decide where the money would be spent.

Participation in a Rural Counties Insurance Control Project being proposed by Reagan County Judge Mike

Elkins, and Kathleen Miller, a loss control specialist from San Angelo could save the county as much as \$60,000 a year and provide more insurance, commissioners learned. They voted to become participants in this self-funded insurance pool.

The annual financial audit performed by an outside firm for the 1993 year was examined and approved, commissioners voted to hire Janet McDaniel as senior citizen coordinator and accepted a bid from Tom Allen for a sheriff's department car previously advertised.

Commissioners voted to go out for bids for stripping, sanding and refinishing wood on walls inside the courtroom and for painting of walls in the courtroom. They also approved sheriff and constable fees for 1995 to remain the same and okayed advertising for a parttime driver for the Thunderbird rural transportation van.

A resolution from the Ministerial Alliance supporting prayer in schools was approved and signed by the court members.

Monthly reports were heard from Garland Young for the civic and youth center, Bob Falkner for the fire department, Eddie Moore for the parks and road departments, Janet Hill McDaniel for Helping Hands and Louise Ledoux for the library.

Tommy Gibbs of Iraan met with the court to request reopening of a

(Continued on pg. 5)



FIRE CHIEF BOB FALKNER accepts a \$500 check from Carlos Judd and Jerry Scoggins from Parker and Parsley. Donations such as these help the department acquire needed equipment.

Supt. Taylor Leads Schools

By Neal Ulmer
Stockman Sportswriter

Larry Taylor, originally from San Antonio, is starting his first year as superintendent of schools for the Crockett County Common Consolidated School District. Mr. Taylor is a 1968 graduate of Southwest Texas State University and received his master of education degree from that university in 1970.

He has previously held the position of superintendent in Ralls and Eden. Also, he has served as a high school and junior high school principal for the Southwest I.S.D. and Edgewood I.S.D. in San Antonio. He served as a counselor for Edgewood I.S.D. and as a teacher for Memorial High School in San Antonio from 1970-73.

Taylor was involved in school sports, a member of the National Honor Society, OAP, FFA, the president of the senior class, and served on the annual staff.

Presently, he is a member of the Phi Delta Kappa, the Texas Association of School Administrators, and the Texas Association of Community Schools.

Fishing, hunting, tennis, golf,

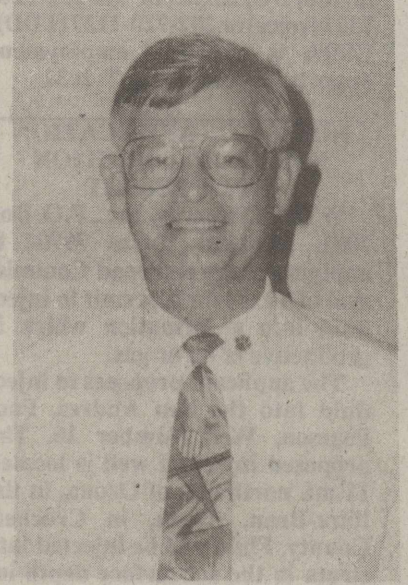

hiking, traveling, reading, and working with people are Taylor's hobbies when time allows in his busy schedule.

Married to Carolyn Taylor, the couple have two sons, Clayton and James. Clayton is a teacher and coach for the Paint Rock I.S.D., and James is a senior at Texas A&M majoring in industrial distribution.

Workman's Comp Record Improves

At the hospital board meeting Sept. 6, members reviewed a financial report which showed cash deposits up for August. Figures also reflected the cost effectiveness of recent staff reductions. Workman's comp costs may further decrease at the end of a probationary period which ends in October. The hospital and care center have had no losses reported by the insurer as of June 30, an outstanding record for any facility, said administrator Gerry Phillips.

Enlargement of the care center by moving the double doors between the center and the hospital is still in the licensing stage. The next step in the project will be to go to the architects.

Phillips said Fred Baker has volunteered for the position of ombudsman for the care center. This unpaid position is that of a liaison between the facility and the state agency. The program is designed to help residents.

In a portion of his report based on recent staff requests, Phillips said the pager system for the emergency room is in but has not yet been installed. The narcotic drug box for the ER will be discussed at the pharmacy and therapeutic meeting on Sept. 14. He said that doctors are not in favor of expanding current orders on file at this time. He also reported that the Health Net video location in the nurses' station is working out better by being more accessible to the staff.

The Ozona Stockman



"Out in the West, Where the Air is Pure, The Climate Agreeable, And the People Friendly—The Best Place On Earth To Call Home."

and the Crockett County News

"The Ozona Stockman (UPS-416-820) is published weekly for \$16.00 per year in Crockett County, \$18.00 per year elsewhere in Texas and \$19.00 out-of-state by Mr. and Mrs. John S. Moore, 1000 Ave. E., Ozona, Texas 76943-0370. Second class postage paid at Ozona, Texas 76943. POSTMASTER: send address changes to THE OZONA STOCKMAN, P.O. Box 370, Ozona, TX 76943-0370."

MR. & MRS. JOHN S. MOORE - Publishers
LINDA MOORE - Editor

JON MORAN - Pressroom Foreman
NEAL ULMER - Sports and Photography

Published weekly since 1913 and entered as second class matter April 9, 1913, at the Post Office at Ozona, Texas, under the Act of Congress of March 3, 1879. Published each Wednesday.

Notices of Church entertainment where admission is charged, card of thanks, resolutions of respect and all matter not news, will be charged for at regular advertising rates. Classified ads and cards of thanks are payable in advance unless customer carries a regular account.

Any erroneous reflection upon the character of any person or firm appearing in these columns will be gladly and promptly corrected if called to the attention of the management.

Publisher is not responsible for copy omissions, typographical errors or any other unintentional errors that may occur other than to make a correction in next issue after it is brought to his attention. Publisher reserves the right to cancel any advertisement at any time.

CLASSIFIED RATES

18 cents per word. Minimum charge \$3.50 per insertion

TELEPHONE (915) 392-2551
ADDRESS - 1000 Avenue E.
P.O. Box 370, Ozona, Tx 76943



MEMBER 1994

TEXAS PRESS ASSOCIATION

Public Notices

BIDS NOTICE

The Crockett County ASCS office is accepting bids for janitorial services. Contract dates will be Nov. 1, 1994-Oct. 31, 1995. Office will be cleaned 5 times a week. Anyone interested should come by the ASCS office at 1205 Ave. B and pick up a bid packet. Offers will be accepted through 5:00 p.m. Sept. 30, 1994.

"The United States Department of Agriculture (USDA) prohibits discrimination in its programs on the basis of race, color, national origin, sex, religion, age, disability, political beliefs, and marital or familial status. (Not all prohibited bases apply to all programs.) Persons with disabilities who require alternative means for communication of program information (braille, large print, audiotape, etc.) should contact the USDA, Office of Communications at 202-720-5881 (voice) or 202-720-7808 (TDD).

To file a complaint, write the Secretary of Agriculture, U.S. Department of Agriculture, Washington, DC, 20250, or call 202-720-7327 (voice) or 202-720-1127 (TDD). USDA is an equal employment opportunity employer." 2c31

NOTICE OF APPLICATION FOR FLUID INJECTION WELL PERMIT

WYNCO Energy, Inc., P.O. Box 2081, Midland, Texas 79702 is applying to the Railroad Commission of Texas for a permit to inject fluid into a formation which is productive of oil or gas.

The applicant proposes to inject fluid into the San Andres, Paul Pearson, Well Number 10. The proposed injection well is located 11 mi. northwest of Ozona, in the Pure-Bean, South, in Crockett County. Fluid will be injected into strata in the subsurface depth interval from 1428 to 1634 feet.

LEGAL AUTHORITY: Chapter 27 of the Texas Water Code, as amended, Title 3 of the Natural Resources Code, as amended, and the Statewide Rules of the Oil and Gas Division of the Railroad Commission of Texas.

Requests for a public hearing from persons who can show they are adversely affected, or requests for further information concerning any aspect of the application should be submitted in writing, within fifteen days of publication, to the Environmental Services, Oil and Gas Division, Railroad Commission of Texas, Drawer 12967, Capitol Station, Austin, Texas 78711 (Telephone 512/463-6790). 1c31

NOTICE OF APPLICATION FOR OIL AND GAS WASTE DISPOSAL WELL PERMIT

Elkhorn Oil & Gas, LLC, 300 N. Marienfeld, Ste. 1100, Midland, Texas 79701 has applied to the

Railroad Commission of Texas for a permit to dispose of produced salt water or other oil and gas waste by well injection into a porous formation not productive of oil or gas.

The applicant proposes to dispose of oil and gas waste into the Ellenburger Shannon A, Well Number 7. The proposed disposal well is located 20 miles NW of Ozona in the Elkhorn (Ellenburger) Field, in Crockett County. The waste water will be injected into strata in the subsurface depth interval from 1691 to 7840 feet.

LEGAL AUTHORITY: Chapter 27 of the Texas Water Code, as amended, Title 3 of the Natural Resources Code, as amended, and the Statewide Rules of the Oil and Gas Division of the Railroad Commission of Texas.

Requests for a public hearing from persons who can show they are adversely affected, or requests for further information concerning any aspect of the application should be submitted in writing, within fifteen days of publication, to the Underground Injection Control Section, Oil and Gas Division, Railroad Commission of Texas, Drawer 12967, Capitol Station, Austin, Texas 78711 (Telephone 512/445-1373). 1c31

NOTICE OF APPLICATION FOR OIL AND GAS WASTE DISPOSAL WELL PERMIT

Elkhorn Oil & Gas, LLC, 300 N. Marienfeld, Ste. 1100, Midland, Texas 79701 has applied to the Railroad Commission of Texas for a permit to dispose of produced salt water or other oil and gas waste by well injection into a porous formation not productive of oil or gas.

The applicant proposes to dispose of oil and gas waste into the Ellenburger Shannon A, Well Number 9. The proposed disposal well is located 20 miles NW of Ozona in the Elkhorn (Ellenburger) Field, in Crockett County. The waste water will be injected into strata in the subsurface depth interval from 1723 to 8730 feet.

LEGAL AUTHORITY: Chapter 27 of the Texas Water Code, as amended, Title 3 of the Natural Resources Code, as amended, and the Statewide Rules of the Oil and Gas Division of the Railroad Commission of Texas.

Requests for a public hearing from persons who can show they are adversely affected, or requests for further information concerning any aspect of the application should be submitted in writing, within fifteen days of publication, to the Underground Injection Control Section, Oil and Gas Division, Railroad Commission of Texas, Drawer 12967, Capitol Station, Austin, Texas 78711 (Telephone 512/445-1373). 1c31

FOR ALL YOUR PRINTING NEEDS COME TO
The Ozona Stockman
1000 Ave. E

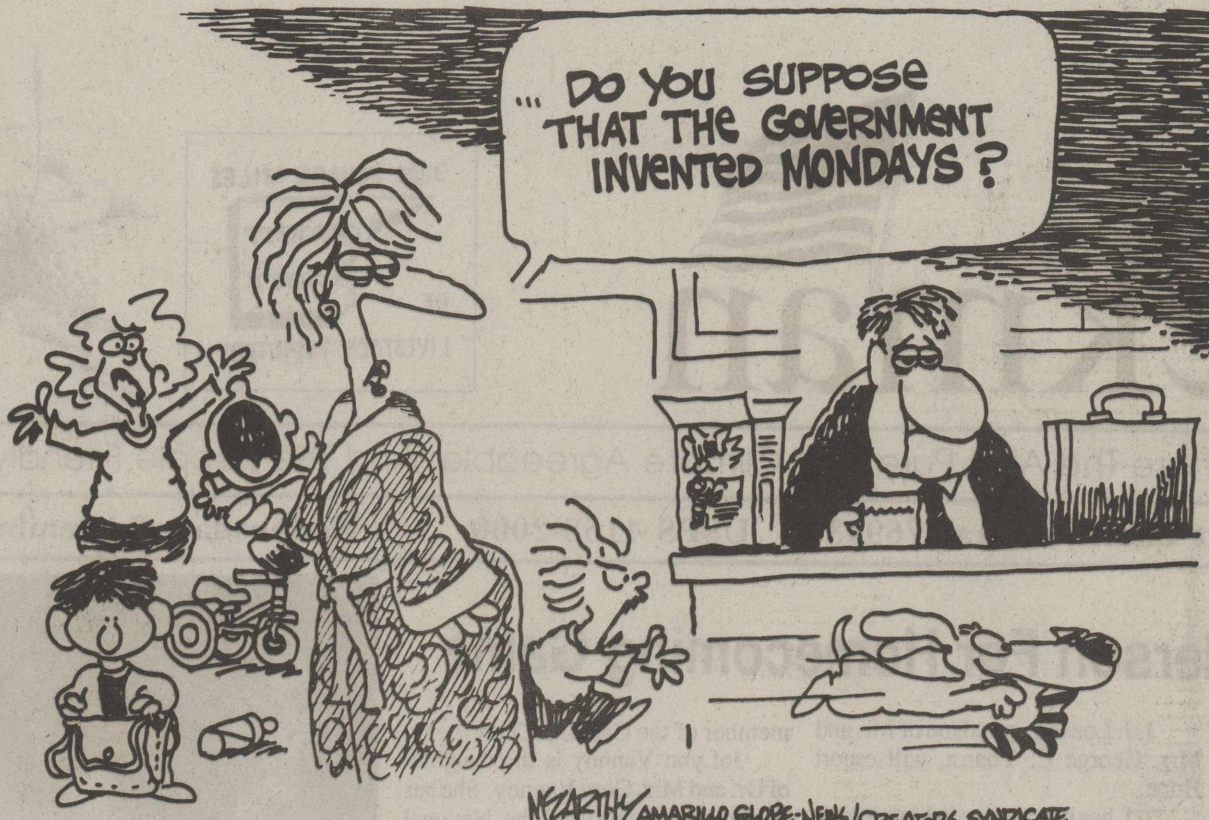

THE NEWSREEL

A rerun of "The Ozona Story" as gleaned from the files of The Ozona Stockman

NEWS REEL SEPT. 9, 1965

News Reel
Mrs. Dempster Jones underwent minor surgery in a San Angelo hospital Wednesday morning.

News Reel
The Ozona Woman's Club will meet Tuesday afternoon, Sept. 14, at the home of Mrs. Joe Bean, president.

News Reel
The Ozona High Choir, a new elective this year, is off to a fine start with an enrollment of 56 members. Tom Sims, director of the choral group, is also Minister of Music and Education at First Baptist Church.

News Reel
Funeral services were held in San Angelo last week for Herman Schneemann, 82, a brother of Max Schneemann of Ozona, who died in Baptist Memorial Hospital there after a long illness.

News Reel
Edward A. Deland, 58, a long-time resident of Ozona and in recent years a construction worker in Odessa, died last Friday morning in Crockett County Hospital after a long illness.

News Reel
Mrs. Charles L. Williams, 79, pioneer Crockett County mother, died at mid-morning Wednesday in Crockett County Hospital.

News Reel
With the newly installed lighting system ready to be turned on for the first time, the Lions will be hosts tomorrow night to the Bronte Long-

horns in the first home football game of the young 1965 season.

News Reel
D. A. Parker, former Ozona High School football coach, was a recent visitor to Ozona. Mr. Parker was a visitor in the home of his brother, J. B. Parker.

News Reel
Miss Judy Ingham, daughter of Mr. and Mrs. B. B. Ingham, Jr., and a 1965 graduate of Ozona High School, will leave Sunday for San Angelo where she will enroll in Angelo State College.

News Reel
Mr. and Mrs. Claud Leath and Mrs. Clyde Leath returned from Bonham last week where they attended the funeral of Mr. Leath's uncle, J. H. Leath.

News Reel
Weekend guests of Mrs. Vera Baker were her grandchildren and great grandson, Mr. and Mrs. Charles Martin and Charles, and friends, Mr. and Mrs. Ray Murski and son, Michael, all of Dallas.

News Reel
Bryan Montgomery and Moe Barbee left Tuesday for their respective schools, Bryan to Fort Worth and T. C. U. and Moe to Colorado State.

News Reel
Leon Drago, a summer graduate of San Houston State Teachers College at Huntsville, has accepted a position as band instructor at Lakeview Junior High School in San Angelo.

NEWS REEL SEPT. 10, 1936

News Reel
Vic Montgomery, son of Mr. and Mrs. George Montgomery of Ozona, left Saturday for Fort Worth to be ready to enroll at T. C. U.

News Reel
Mr. and Mrs. Jack Baggett and Miss Linora Dudley of Dallas were guests of Mrs. Alvin Harrell and Mrs. B. B. Ingham the past week.

News Reel
Miss Margaret Butler, daughter of Mr. and Mrs. S. L. Butler, will leave Friday for Waco where she will resume her studies in Baylor University.

Thunderbirds Highlight Air Amistad '94

LAUGHLIN AFB, Texas - The finishing touches are in place for Air Amistad '94, Laughlin's annual air show, Sunday, Sept. 18, starting at 10 a.m.

The highlight for this year's air show is the afternoon performance by the U.S. Air Force Air Demonstration Squadron, The Thunderbirds. Since their official activation in May 1953 at Luke AFB, AZ, The Thunderbirds have performed in all 50 states and 56 foreign countries.

Belated greetings for a happy birthday go to Beatrice Haire who celebrated her special day Sept. 12. Joining the celebration were her granddaughter, the former Cathy Evans, and her children, Wendell and Janet, all of San Angelo.

Political Announcements

SUBJECT TO THE ACTION OF THE NOVEMBER GENERAL ELECTION

For County Judge:

Jeffrey Sutton
(Pol. adv. pd. by Jeffrey Sutton, Box 1534, Ozona, Texas 76943)

Troy Williams
(Pol. adv. pd. by Troy Williams, Box 130, Ozona, Texas 76943)

For County Clerk:

Debbi Puckett
(Pol. adv. pd. by Debbi Puckett, Box 75, Ozona, Texas 76943)

For Justice of the Peace:

James M. (Jim) Heare
(Pol. adv. pd. by James M. Heare, Box 354, Ozona, Texas 76943)

For 112th District Judge:

M. Brock Jones Jr.
(Pol. adv. pd. by M. Brock Jones Jr., H.C. 69, Box 35, Ozona, Texas 76943)

For County Commissioner, Precinct 2

Fred Deaton
(Pol. adv. pd. by Fred Deaton, Box 1087, Ozona, Texas 76943)

For County Commissioner, Precinct 4

Rudy Martinez Jr.
(Pol. adv. pd. by Rudy Martinez Jr., Box 314, Ozona, Texas 76943)

For County Treasurer, Unexpired Term

Burl Myers
(Pol. adv. pd. by Burl Myers, Box 3060, Ozona, Texas 76943)

James J. Healy Jr. Service In Virginia

James J. Healy Jr. of Sterling, VA, died Monday, Sept. 5, 1994. A Mass of Christian burial was held Sept. 9 at St. Joseph's Catholic Church in Herndon. Interment was in Chestnut Grove Cemetery with military honors.

He received his bachelor of art degree from Providence College in Providence, RI, in 1980 and his master's degree from the University of Hawaii in 1986. He served in the U.S. Army from 1980-86 as an analyst and had worked for the CIA from 1986 until his death. He was preceded in death by his parents, James J. Healy and Ann Marie Healy.

Survivors include his wife, Barbara A. Sanchez Healy, formerly of Ozona, of Sterling; one brother, Mark P. Healy of Abington, MA, one sister, Julie Gagne of Florida; and aunts and uncles, Mr. and Mrs. Richard Igo Sr. of Hingham, MA, Mr. and Mrs. Thomas Strange of Whitman, MA, Mr. and Mrs. Jack Strange of Hanson, MA, and Miss Mary Healy of Abington, MA.

Memorials may be made in memory of James J. Healy Jr. in care of Johns Hopkins University, Dept. of Surgery, 600 N. Wolfe, Blalock 665, Baltimore, MD 21287.

Lee Graves Service Sunday

Lee Graves died Thursday, Sept. 8, 1994, in Lubbock at the age of 78. Service was Sunday at Ozona First Baptist Church with burial in Cedar Hill Cemetery.

Caruthers Service Held Aug. 26

Norine Caruthers, a retired educator, died Tuesday, Aug. 23, 1994, in Bridgeport. She was 86.

Funeral service was Aug. 26 at First United Methodist Church in Bridgeport, where she was a member. Burial followed in Paradise Cemetery.

Mrs. Caruthers was born in Menard and was a lifelong Wise County resident. She received her bachelor's and master's degrees from the University of Texas.

Survivors include her husband of 53 years, Guinn Caruthers of Paradise; a brother, W. W. Allison of Fort Worth; four sisters, Frances Hyatt of Commerce, Cora Adams of Dallas, Johnnie Allison of Fort Worth and Ruby Utsey of Brady.

Baptist Church with burial in Cedar Hill Cemetery.

Mr. Graves was born May 9, 1916, in Ozona. An Air Force veteran of World War II, he was a longtime rancher and had been the foreman of the Ranching Heritage Center at the Museum of Texas Tech University for eight years.

Survivors include his wife, Joyce-Lyn Graves of Ozona; three daughters, Jackie Crone of Memphis, TN, Laura Graves of Levelland and Joyce Graves of Shallowater; two sons, Buddy Graves and Lee Jay Graves, both of Austin; six grandchildren; and a great-granddaughter.



Business & Professional Guide

OZONA BUTANE CO.
Propane Gas • Sales & Service
Hwy. 163 S.
392-3724

HAYES AUTO REPAIR
Mechanic on Duty
• Small Engine Repair
• Lawn Mower Repair
• Minor Tuneups
392-3224 1311 Ave. AA

HAPPY HOLLOW TOYS & GIFTS
Mon. - Sat. - 8:30 a.m. - 5:30 p.m.
Open During Noon Hour
1010 Ave. E 392-3403

HOUSE FUEL COMPANY
Wholesale Fuel and Oil
103 Ave. E.
392-3010

BAKER AUTOMOTIVE
1206 Ave. D (915) 392-2905
Home-392-3874 Cell.-1-650-2850
COMPLETE AUTO REPAIR
Foreign & Domestic
ASE Certified Reasonable Rates

BASKETS AND MORE
Blanca Martinez, Owner
• Ornamental Plants • Silk Flowers
• Gardening Supplies • Landscaping
110 AVE. I 392-3582

CAMERAS TWO PHOTOGRAPHY & FRAME SHOP
404 Ave. J 392-2256

THE DOG PATCH Grooming Shop
Baths • Dip • Clip 392-3415 392-5407
Leave Messages Carol Cook Sheryl Pollard
Monday - Thursday 9 to 5 • 901 Ave. J

This space for rent
\$3.00 per week

HELPING HANDS SENIOR CITIZENS CENTER
903 Twelfth St.
392-5026

Come check our prices for wedding invitations, napkins and accessories
THE OZONA STOCKMAN
1000 Ave. E 392-2551

M & B SPRAYING & PRUNING SERVICE
Free Estimates
• Tree Topping • Tree Trimming
• Tree Spraying
392-3253 - leave message

This space for rent
\$3.00 per week

FREDDY'S CHEVRON STATION
Full Service Station
825 11th 392-2016

CROCKETT COUNTY MUSEUM
Mon. - Fri. 9-5 p.m.
Saturday 10-4 p.m.
For special tours, call 392-2837 or 392-2123

FIRST BAPTIST CHURCH
Sunday School 9:45
Morning Worship 11:00
Evening Worship 6:00
Prayer Service Wed. 6:45 p.m.

CALVARY BAPTIST CHURCH
Sunday School 9:45
Morning Worship 11:00
Evening Worship 7:00
Prayer Service Wed. 7:00
Rev. Daniel C. Fleming

KNOX FLOOR COVERING
MasterCard VISA
Ozona, Texas

This space for rent
\$3.00 per week



Miss Carter, Mr. Cain Marry In Ranch Ceremony

Sandra Renea Carter became the bride of Casey Lee Cain Saturday, Sept. 10, 1994, in a ceremony held at the Cain Ranch home.

The bride is the daughter of Mrs. Sandra Chambers of Odessa. Parents of the bridegroom are Mr. and Mrs. Lonye Cain of Ozona.

Justice of the Peace and longtime friend Jim Hearne officiated the ceremony.

Rodney Storms gave the bride in marriage. She wore a white poet's blouse and white jeans with fuchsia belt and boots. Her tiny western hat was adorned with a waist-length scalloped lace bow.

The bride's attendant, Deklyn Coates, wore burgundy jeans and an off-white lace shirt.

The bridegroom wore burgundy slacks and a white tuxedo shirt and straw hat. Best man was Cody Cain, brother of the bridegroom.

Wedding vows were recited at dusk on the lawn of the ranch home while young Zane Coates held two very special wedding rings. Renea chose to wear the wedding rings of her great-grandmother, the late Mrs. Shafer, and Casey chose to wear the ring of his grandfather, the late O.H. Ake.

The bride's cake was of three-tiers topped with a Precious Moments cowboy and cowgirl given by the bride's mother, Ms. Chambers.

Happy Birthday
to Ismael Castro
on Sept. 17
from Mom and Dad
brothers and sisters
and nephews
and wife & Miley

Southern Living House Thursday Topic For FCE

An "armchair tour" of the 1994 Southern Living Idea House in San Antonio is on tap for this month's Family Community Education Club meeting at 10 a.m. of 7 p.m. Thursday, Sept. 15, at the civic center.

County Extension Agent Tedra Ulmer invites all interested persons to view a slide presentation about the idea house. "If you're not familiar with the concept," she said, "Southern Living Magazine designs and decorates several new homes in different areas of the country each year. These are open to the public and great for getting ideas you can do in your own home, from paint treatments to the latest trends in materials and home furnishings."

The Family Community Education Club is open to all interested persons, and there is no charge to attend. For more information, contact the Crockett County Extension Office at 392-2721. Individuals with disabilities who require an auxiliary aid, service or accommodation in order to participate in this meeting are encour-

aged to contact Tedra Ulmer at that number prior to the meeting to determine how reasonable accommodations can be made.

The Southern Living Idea House, named the "Star of Texas", features a limestone and stucco exterior highlighted by a tin roof. The traditional "dogtrot" plan is around 2,500 square feet and includes three bedrooms, three baths, kitchen/family room, and a study. The newest materials, fixtures and construction techniques were used to provide convenience and energy efficient living. The landscaping features native plants which help in water conservation. "You'll enjoy looking at the features of this home, many of which can be inexpensively used in your own home decorating schemes," said Ulmer, "regardless of the age or size of the home you have now!"

Educational programs conducted by the Texas Agricultural Extension Service serve people of all ages, regardless of socioeconomic level, race, color, sex, religion, national origin or disability.

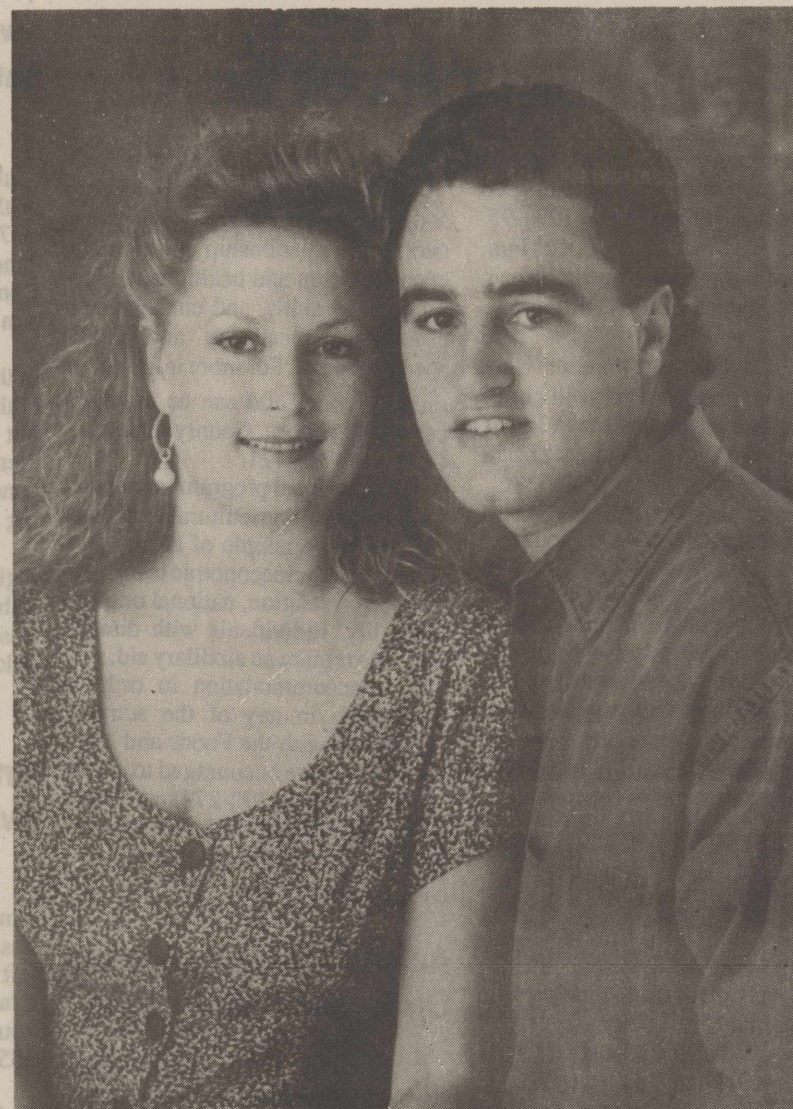

Mr. and Mrs. Walter Miller Married In Las Vegas

Announcing their marriage on August 20, 1994, in Las Vegas, Nevada, are Walt and Stacy Miller. Stacy is the daughter of Mr. and Mrs. Steve Kenley of Ozona and Mr. and Mrs. Joe Boy Chapman of Del Rio. She is the granddaughter of Mrs. Lonnie Nolan, also of Del Rio, and Mrs. J. W. John-

gan of Ozona. Walt is the son of Ms. Patsy Miller of San Antonio and the late Jay Miller of Ozona. He is the grandson of Mr. and Mrs. Eugene Miller of Ozona. The couple live in San Antonio where Stacy is a nursing student and Walt is employed by Richter Construction.

Bobbie Fatout Comended By Sorority

On Monday, Sept. 12, at 7 p.m. Preceptor Mu Chi members held their meeting at Crockett County National Bank. After the opening ritual, Nancy Hale, president, called the meeting to order. Minutes were read and the treasurer's report was given.

A letter from International Headquarters was read congratulating Bobbie Fatout for 25 years of sisterhood.

The convention will be held in San Antonio June 30-July 2 of 1995. Early registration will enable one to be in the drawing for a three day cruise. All sorority sisters were asked to keep this date in mind.

A program was given by Tedra Ulmer on the Trends of Living, showing slides to illustrate and give ideas in

fixing up your home and just how easy it can be.

After the closing ritual was said Zoe Green served refreshments. Those attending were: Nancy Hale, Brenda Newton, Jeanne Wellman, Betty Koerth, Billie Jean Morris, Mavis Dunlap and Terry Adams. Honored guest was Barbara Carter. The next meeting will be Sept. 26.

Terry Adams reporting

YOUR NEWS IS WELCOME AT THE STOCKMAN. 392-2551.

Jeanie Cooper
bride-elect of
Christopher Michael
Trolinger

Mrs. Casey Cain
née
Renea Carter

Jamie Dalby
bride-elect of
Gilbert Valdez

Melissa Vallejo
bride-elect of
Paul Tambunga
have made selections at

South Texas
Lumber Co.

Card of Thanks

My son, have I told you lately how much I love you and how proud I am of you? Congratulations on your most recent accomplishment. You'll make one of the best policemen ever!

Mom

Happy Birthday

Alysha

We Love You!

Mom, Dad, and Abey



Tedford Jewelry

Bridal Gift Registry

Jeanie Cooper, bride-elect of Christopher Michael Trolinger
Mrs. A. B. Kimble, née Robin Myers
Mrs. Ty McKinney, née Lesly Mize
Mrs. William G. Truitt, née Jessica Deaton

392-5537

In the Village

Fresh Homecoming

Mums & Corsages

For your convenience we'll be open late for you

to pick up your Homecoming Mums and Garters.

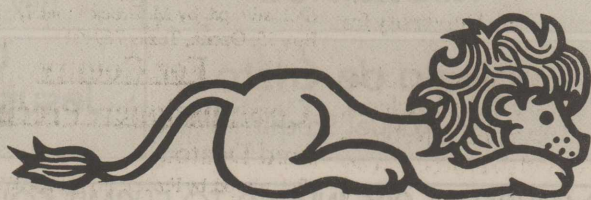

Open 8 - 8 (Monday-Thursday)
8 - 7 (Friday)
9 - 5 (Saturday)

Baskets and More

110 Ave. I -- 915-392-3582

Brown's Brides

Mrs. William G. Truitt
née
Jessica Deaton

Nelda Eddy
bride-elect of
Raul Delgado

Mrs. Ty McKinney
née
Lesly Mize

Mrs. Tommy De Hoyos
née
Lisa Herring

Jeanie Cooper
bride-elect of
Christopher Michael
Trolinger

Melissa Vallejo
bride-elect of
Paul Tambunga

Mrs. Walter Miller
née
Stacy Chapman

have made selections at

Brown Furniture Co.

392-2341 906 Ave. E

Maybe Mom
will come to
Small Fashions

1/3 Off Sale
on clothes

for **Baby**

Infant - 24 months
Starts Wed., Sept. 14

1 week only

Maybe Baby!!



4-H Foods Project Kicks Off Saturday

Experiments with foods, fitness and lots more are in store for 4-H members and parents at the 1994-95 project kickoff workshop "Foods Fun '94" on Saturday, Sept. 17, at the Ozona United Methodist Church Fellowship Hall.

Activities start at 9 a.m. with registration, and members will check their fitness levels as they arrive. Foods for lunch are included in the \$2.50 registration fee.

During the day, members will learn some basics related to foods and nutrition, and parents can find out what the foods and nutrition project is all about, and how to help their child.

Members are asked to bring one can of food for donation to Helping Hands, and they will also assist in setting up and decorating for the Teacher Appreciation Dinner which will be held at the church on Sunday as part of their community service activities for the project. The workshop will conclude at approximately 1 p.m., following the completion of setup for the dinner.

Following the workshop, a series of lessons is planned, beginning with a "Pampered Chef" demonstration of Sept. 19, "What's the Beef" on Sept. 26, "Fitness First" on Oct. 10 and "Menu Planning/Preparing for the Food Show" Oct. 17 and 24. Members must complete a minimum of six lessons to participate in the food show, or complete a self-determined project approved by the County Extension Agent.

A group field trip to the Southern Living Cooking School in San Angelo is slated for Saturday, Oct. 22. There is a \$4 admission charge, and any who wants their tickets ordered in advance should turn in their money as soon as possible.

Parents, grandparents and other adults are welcome at all meetings, and urged to attend with their children. Children who receive support in their project and attend all the lessons generally get more out of the project.

The annual Crockett County 4-H Food Show will be held Saturday, Oct. 29, in the morning; contestants in seven categories and three age divisions will have the opportunity to advance to District competition in Fort Stockton on Dec. 3. Senior contestants will then have the chance to advance to State competition at Texas 4-H Roundup in June. The food show is an optional part of the 4-H Foods and Nutrition project.

Every 4-H member who has signed up for the foods project by completing and turning in an enrollment form has been sent an information letter about the meetings and requirements for the project. "Please read your letter - in bright pink - when you receive it, and call us if you have any questions," said Tedra Ulmer, County Extension Agent - Home Economics, who is in charge of the project, adding, "The list of meetings should be checked for the ones you plan to attend, signed, and returned by Thursday, Sept. 15, or you may turn it in at the workshop on Saturday."

"If you are not yet signed up for foods or have not re-enrolled, the deadline to do so is Saturday, Sept. 17, at the workshop. You can also call our

office to re-enroll," the agent noted.

The purposes of the 4-H Foods and Nutrition project are to teach young people the relationship between science, nutrition and health, teach life-time living skills, and enhance self-esteem, responsibility and public speaking skills. For more information on how your child can be involved, call the Crockett County Extension Office at 392-2721.

Educational programs conducted by the Texas Agricultural Extension Service serve people of all ages, regardless of socioeconomic level, race, color, sex, religion, national origin or disability. Individuals with disabilities who require an auxiliary aid, service or accommodation in order to participate in any of the activities associated with the Foods and Nutrition project are encouraged to contact Tedra Ulmer at 392-2721 as soon as possible to determine how reasonable accommodations can be made.

Achieving Beauty Subject Of Garden Club Meeting

Members of Ozona Garden Club met at the civic center for the first meeting of the year with horticulturist John Begnaud, county Extension agent of Tom Green County, presenting a program on *Learning How to Achieve Beauty*.

Hostesses Lou Deaton and Linda Hixson served refreshments to Marolyn Bean, Sue Burns, Sybil Howell, Virginia Hubbard, Camille Jones, Mary Jo Mason, Ethel Miller, Dorothy Montgomery, Katharine Russell, Marge Smith, JoNel Stokes, Grace Williams and Joney Williams.

Plans were made for the annual second time around sale to be held Oct. 29.

Sue Burns reporting

Field And Stream Meeting

The 4-H Field and Stream group will meet Monday, Sept. 19, at 6:30 p.m. in the civic center.

Your news is always welcome at The Stockman. Call 392-2551 or come by the office at 1000 Ave. E.

26 And God said, Let us make man in our image, after our likeness: and let them have dominion over the fish of the sea, and over the fowl of the air and over the cattle, and over all the earth, and over every creeping thing that creepeth upon the earth.

Genesis 1:26

Courtesy of
**Childress
Real Estate**

Levis And Lace Fall Promotional Slated For Sept. 17

Levis and Lace Square Dance Club will have a dance in the gazebo on the town square Saturday, Sept. 17, at 7:30 p.m. to promote fall square dance lessons. Lessons will be at the Comfort Inn beginning Sept. 19 at 7 p.m. The first two lessons are free.

Everyone is welcome to the dance in the park at no charge. It is the hope of the club not only to get new dancers but to encourage the return of old members and people who may have danced somewhere else before coming to Ozona.

There will be a table set up for registration and lots of Angels around to help get you registered for the fall lessons. Classes will be taught by Carol Adcock.

Arts And Crafts Guild Plans Events For Crafts Show

The 1994 Nov. 5 crafts show is almost full with some of your favorites returning. There are few booths left for the Crockett County Arts and Crafts Guild annual show and sale. If you want to reserve a booth, call 392-3557.

The Guild will have their Win a Fish booth again at the Halloween Carnival planned for Monday, Oct. 31.

Officers for the new club year will be elected Sept. 12 at the regular monthly business meeting.

A painting class is scheduled for Sept. 24. Hours will be from 9 a.m. to noon followed by a covered dish luncheon and painting from 1 to 3 p.m.

Tommy Kay O'Bryant will teach a watercolor sunflower technique on a white tuxedo shirt, T-shirt, blouse or piece of white cotton material.

A supply list and project will be on display at Perry's. The store will have some of the supplies for sale. The paint is not available to buy and will be

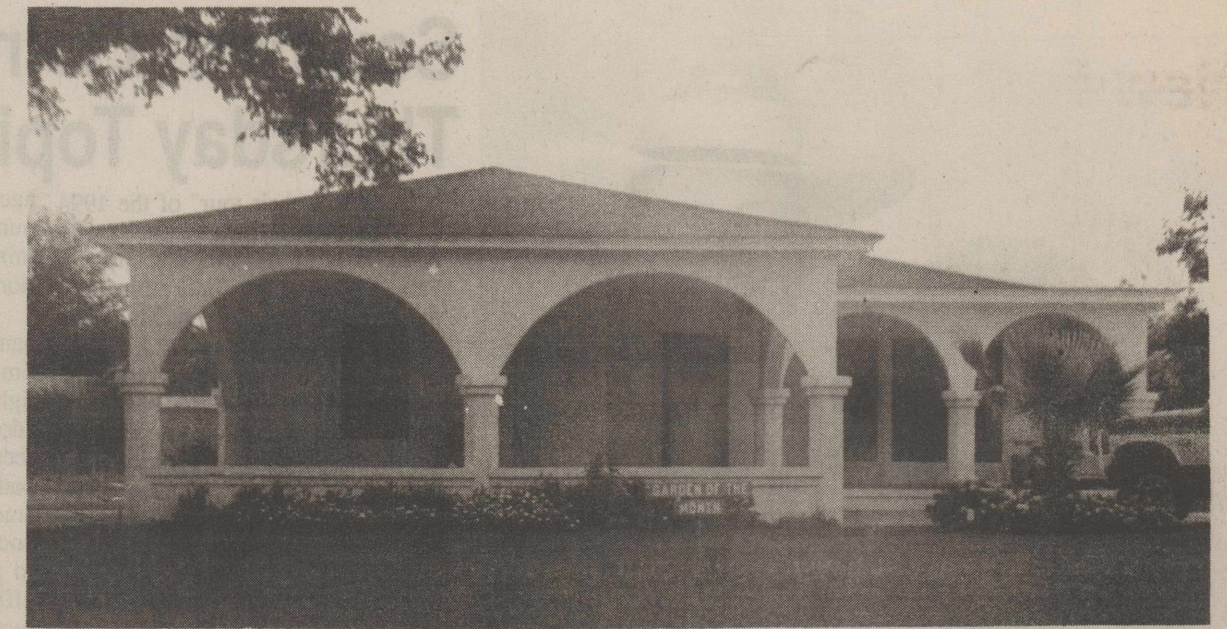

THE HOME OF IRMA AND DANNY MORAN at 222 Ave. H has been selected by Ozona Garden Club as Garden of the Week. Palm trees, cactus, impatiens, elephant ears and marigolds make the yard a showplace.

furnished by the teacher for Guild members, senior citizens and care center residents for \$3. Charge is \$4 for any other senior citizen (\$5 and over) and \$5 for anyone else.

Door prizes will be given. Call 392-3557 for more information on the painting class.

Meals On Wheels Menu

Monday, Sept. 19
Baked Pork Chops with Dressing, Chopped Broccoli, Bread, Banana Pudding

Tuesday, Sept. 20
Italian Delight Casserole, Zucchini and Tomatoes, Steamed Carrots, Bread, Lime Jello Dessert

Wednesday, Sept. 21
Baked Chicken Quarters with White Rice, Mixed Vegetables, Bread, Fruit Salad

Thursday, Sept. 22
Swiss Steak, Mashed Potatoes, Green Beans, Rolls, Pineapple Dessert

Friday, Sept. 23
Beef Stew, Rotini Salad, Cornbread, Cake Square

When I play with my cat, who knows but that she regards me more as a plaything than I do her?
—Montaigne

Lion Pride Paw Print Sale

Every tag with a Lion Paw Print is \$1 Off

Our already Low Low Prices
Come in this Homecoming Week
and Help us Celebrate

Lion Pride

Paw Print Sale

Wed. 14 - Sat. 17

New hours

Mon. - Sat. 10:00 - 5:30

Cell. 915-226-3261

1103 Ave. E

(behind Poco Taco)

"Wild-n-Woolly"

Second Chance Store

Upscale Resale

for the

Value Conscious Shopper

Happy Sweet 16
Love
Mom & Guelo

Making Possibilities

By Dennis J. Prutov

The book of Ruth in the Old Testament of the Bible tells the story of a young lady who lost her husband, her brother-in-law, and her father-in-law. Her name was Ruth. Was there the possibility of a better life for Ruth? Could her sorrowing mother-in-law, Naomi, also find a new beginning?

These ladies traveled back to Bethlehem, their home town. Being

poor, Ruth picked grain left by reapers in the harvest field. The Bible says Ruth happened into the field of a relative by the name of Boaz. As the story unfolds, Boaz helps Ruth and Naomi with food. Boaz also takes the legal steps necessary to return the family farm to Naomi. In the process, he and Ruth are married.

This is a charming story of hope, love and new beginnings. But these two women, who lost everything,

would never have experienced a new start in life by sitting around and sulking. The same is true with you and me. We can bemoan our poverty, ill health, or lack of education. And we can wallow in self-pity. Or we can place ourselves in the position where the unexpected can happen. As this is true on a physical plane, it is true on the spiritual level. If we don't place ourselves within earshot of the Bible, we cannot expect to experience the love of God.

First Baptist Church Rev. Bill Fuller	Ozona Church of Christ Mr. Rodney Hamon	Ozona United Methodist Church Rev. James Carter
Mt. Zion Baptist Church Rev. Narvell Allen	Faith Lutheran Church Charles Huffman, Pastor	Templo Siloe Assembly of God Church Rev. Matilde Ortega
Templo Bautista	Church of God of Prophecy Pastor Onofre Rodriguez	Our Lady of Perpetual Help Rev. Bill DuBuisson
Calvary Baptist Church Rev. Daniel C. Fleming	Iglesia Bautista Nueva Vida	Apostolic Church Rev. Fillberto Prieto
Harvest Time Christian Center Assembly of God Rev. Wayne Woody	Iglesia de Cristo Sr. Manuel Suchil	Church of Jesus Christ of LDS 392-5854

ALL PASTORS OF OZONA CHURCHES ARE INVITED TO SUBMIT COLUMNS.

Westerman Drug
Ozona National Bank
South Texas Lumber. Co.
T&T Village Supermarket

This series of ads is being published and sponsored by these Ozona business firms in the interest of a stronger community.

House Fuel
Ozona Butane Co.
Shot's Convenience Stores
Crockett County National Bank

BEST BUY OF THE MONTH

KING KOIL SLEEPWELL
MATTRESS & FOUNDATION SETS

TWIN SIZE \$140	QUEEN SIZE \$225
FULL SIZE \$170	KING SIZE \$275

GUARANTEED

Brown Furniture Co.

906 Ave. E Ozona, TX 392-2341

Ozona United Methodist Church

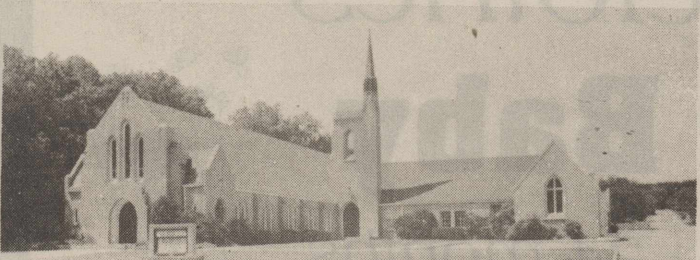

Join us for the
Festival of New Beginnings
in September

Sunday School 9:45 a.m.
Worship 11:00 a.m.
Youth 5:30 p.m.

Jim Carter, Pastor

392-3060

New Faculty For 1994-95



Carolyn Taylor

Raised on a cotton farm in the Rio Grande Valley near Edcouch - Elsa, Carolyn Taylor is glad to be in Ozona. She said, "It is such a clean, beautiful town with friendly people."

With 25 years in the teaching field, Mrs. Taylor has previously taught in Ralls as a second grade teacher; in Edent teaching Chapter I, second grade, and as a basketball and tennis coach; and at Eola and San Antonio.

She graduated with a bachelor of science degree at Southwest Texas State University in 1969 and received her master of arts degree in 1978 from the University of Texas at San Antonio. Currently she is teaching special education at the Ozona Primary School.

When time allows, she enjoys sewing, biking, tennis, and other outside activities. She is married to Larry Taylor, superintendent of Ozona Schools. The couple have two sons, Clayton and James.

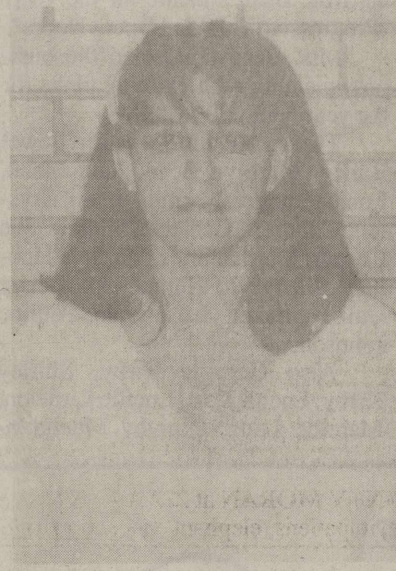

Sandy Gandar

Originally from Sonora and raised in Del Rio, Sandy Gandar received her G.E.D. in December of 1993 in San Angelo. She entered the educational field as a volunteer and worked with non-English speaking students at the Ozona Junior High School in September of 1992. In January of 1993 she substituted as a teacher in different areas.

Currently, Ms. Gandar is working as special education teacher aide for self-contained students. She was hired in this position in January of 1994.

She stays very involved with her three children as a single parent. Her children are Melissa, a freshman; Michael, a fifth grader; and Mark, a fourth grader. She is engaged to David Screws, an assistant superintendent at the Texaco Gas Plant.

Hobbies and other interests include spending time with her children at sporting events, jogging on the track, attending church, and taking long walks in the evenings with David.

"I am really grateful to Mr. Tom Humber, Mr. Don Stark, and the school administration for giving me this challenging job," said Ms. Gandar.

For information you can use, read The Stockman want ads. Buy, sell or trade through The Stockman classified pages.

*Lower Taxes

(Continued from pg. 1)

road in the western part of the county. Commissioners decided more information was needed before any action could be taken.

The flower bed at the South Pool was the topic brought before the court by Chris Borrego. Borrego had previously offered his services and that of a landscaper without charge to develop the area with low maintenance donated plants. \$2,500.00 was spent by the county for plants which are now overcrowding the plot. Borrego presented a petition from citizens asking that something be done about the appearance of the area and again offered his service at no charge. He was asked to get together with Eddie Moore and Commissioner Rudy Martinez to resolve the situation.

The court approved resolutions authorizing the submission of Texas Community Development Program

and Colonia applications to the Texas Department of Housing and Community Affairs as requested by Doug Meador and Dee Keilers. After Keilers told the court he did not expect the water district to favor a proposed agreement to dispose of used oil filters in Big Lake, the court took no action on this agenda item.

Action on a letter from Roy Harrell regarding easement for an area adjacent to the former landfill was tabled until the next meeting.

No action was taken on clarifying rules and regulations for buying and selling of cemetery plots. Judge A. O. Fields appointed Ronald Shaw and Burl Myers to look into removal of asbestos from the courthouse annex. Commissioners agreed that angle parking would relieve some of the parking problems at the courthouse.

Ozona Community Center Needs Donations

By Cynthia Harrell Hodges

The Ozona Community Center has comprised a pre-Christmas wish list of equipment, clothing, and volunteer help that would help it better serve the community.

Donations are needed because the fees charged and collected by the center for its day care service cover only the insurance and staff salaries and utilities. "This is a non-profit organization," explained community center director Kay Baker. "The major source of our funding, the United Methodist Church, has been 'greatly reduced this year'. The center is 'not government funded in any way'."

Items needed by the center include: clothing sizes 2-8 (shorts, T-shirts and underwear - boys and girls); riding toys for playground - tricycles, Big Wheels, etc.; treehouse, swings, basketball goals and poles, poles for volleyball and tether ball, tumble mats for toddler class, playhouse, baby swings for small playground, media equipment, dish rags and towels, storage building approximately 8.5 feet by 9.8 feet, computer monitor (VGA brand), two drawer locking filing cabinet, lawn mower, sandbox, toddler toys for ages 18 months to three years, and a truck load of gravel for playground equipment.

Volunteers are also needed to

serve as playground supervisors and fund raisers. "We also need an electrician to check the electrical fuse boxes at the center. This is not a major problem, but the building was erected in 1939, and things are getting old," said Mrs. Baker. The evaporative coolers need to be cleaned and fixed, and a sprinkler system needs to be installed. Jana Lilly Wilson, a community center board member, donated the sprinkler system. Other Ozona citizens have donated two hot water heaters and a dishwasher. "We would not have these items otherwise."

Any persons wishing to donate his time to repair or install equipment should contact Neal Ulmer, chairman of the grounds committee, at 392-5443 or call the center at 392-2710.

The staffing of the center, save for the position of cook, has been completed. Those working at the center include Del Vinton, Vickie Cornett, who teaches the 18-30 month-olds, and teachers' aide Belia Garza.

The community center also accepts memorials. "Individuals need to either bring the memorial to the center or mail it to P. O. Box 41, Ozona, TX 76943. They need to specify who the gift is in memory of, and how they want their donation used," Mrs. Baker said.

Crockett County Sheriff's Report

WEEK ENDING 9-13-94

ARRESTS:

9-07-94...17-year-old Benito Y. Gutierrez of Ozona was arrested on two warrants charging him with assault. He pleaded guilty in JP Court on one of the charges and not guilty on the other. On 9-12-94 he paid his fine on one charge and posted bond on the other. The case will be tried in JP Court.

9-10-94...51-year-old Juan Martinez of Austin was arrested on traffic warrants out of Kleberg County. He was released after paying his fine.

9-11-94...60-year-old Jorge B. Perez of New Mexico was arrested on charges of driving while intoxicated. He was later released after posting bond on the charge. The case will be tried in county court.

9-11-94...40-year-old Anacieto Rodriguez of Del Rio was arrested on charges of driving while intoxicated. He was later released after posting bond on the charge. The case will be tried in county court.

9-12-94...35-year-old Charles S. Britt of Ozona was arrested on charges of driving while intoxicated. He was later released after posting bond. The case will be tried in county court.

INCIDENTS:

9-6-94...An Ozona man reported the theft of two checks from his pickup. Sheriff's deputies took the report and began to investigate. The report was later cancelled because the complainant found his checks. No theft had occurred.

9-7-94...Reuben Whitehead reported 30 head of lambs missing from his pasture on the O.B. Trap north of town. Sheriff's deputies are investigating the offense.

9-10-94...Bob Rodriguez reported the theft of a CB radio from a Pool truck that was assigned to him. The theft occurred at the Pool yard north of town. Sheriff's deputies are investigating the theft.

9-12-94...Edward G. Ledbetter of May reported the theft of a set of golf clubs from his pickup. He believes that the offense occurred at the truck stop. Sheriff's deputies are investigating the offense.

Study Club Hears Program On Russia

The Pandale Study Club met Sept. 8, 1994, at the Pandale Community Center.

Rev. Bill Fuller and music director Rodney Peyton of First Baptist Church of Ozona presented an interesting program. Rev. Fuller told about his trip to Russia and the family he stayed with and about the teenagers he met.

The program was followed by a delicious lunch prepared by hostess Betty Klepper. Present to share this were: Sara Hargraves, Opal Everett, Maycee Collins, Shelba Fachl, Lou Deaton and guests Jean Finch, Mary Hufstler and Keith Klepper.

Alexander Honored

Kay Kyle Alexander has received the Rome Betts Award of Excellence for Community Organization for the second time.

This national award is given annually by the American Heart Association to recognize outstanding staff. Mrs. Alexander is the regional director for the West Central Texas region, which includes 15 counties surrounding Abilene. She is also gala consultant for the Texas Affiliate.

"Because volunteers in this area are so dedicated to fighting heart disease and stroke, my work is very enjoyable," she said. "I get to see the best in people on a daily basis as they give unselfishly of their time and money."

It's A Girl!

Dean and Wendy Shaw of St. Louis MO, are the proud parents of a baby girl. Kelly Ann was born Sept. 8, 1994, at St. Luke's Hospital in St. Louis at 4:48 p.m.

The little girl weighed seven pounds, 10 ounces at birth and was 27" long. Helping greet her were her two sisters, Denna and Alyssa.

Proud grandparents are Mr. and Mrs. Harold Shaw of Ozona.

BERNARD RUST D.D.S.
FAMILY DENTISTRY
New patients & emergencies welcome
INSURANCE ACCEPTED
CALL TOLL-FREE
1-800-530-4159
Mon. - Thurs. - 8:00 - 5:30
Fri. 8:00 - noon
901 S.E. Crockett Sonora, Texas

NOW ACCEPTING American Express, M/C & Visa
Now Accepting BC/BS Federal Employee Plan, SMG/Mednet,
Paid, Avesis, Perform Medimat, Value Rx, PCS, PCN, BC/BS & PRxN cards
FREE DELIVERY
Westerman Drug
R 392-2608
Home - 392-5688
Laura Parker would like to be your pharmacist.

COUNTRY CABLE
Country Cable of USA - TV at its finest, Cable programming for the country or town. You've heard about the rest, now try the BEST. No long waiting list.
For appointments call Chris Jones (Sales Rep.)
915-942-0472

512 9th St. - Ozona Location
392-2444
Hero's PIZZA
Make It A Large MEDIUM CHARGE!
HERO'S PIZZA DELIVERY * CARRYOUT * DINE IN
One coupon per party per visit at participating Hero's Pizza outlets. Please mention coupon when ordering. Not valid with any other offer.
Medium Pizza \$8⁹⁹
Second Pizza \$4⁰⁰
HERO'S PIZZA DELIVERY * CARRYOUT * DINE IN
One coupon per party per visit at participating Hero's Pizza outlets. Please mention coupon when ordering. Not valid with any other offer.
Large Pizza \$10⁹⁹
Second Pizza \$6⁰⁰
HERO'S PIZZA DELIVERY * CARRYOUT * DINE IN
One coupon per party per visit at participating Hero's Pizza outlets. Please mention coupon when ordering. Not valid with any other offer.

OPEN:
Monday - Thursday: 11:00 a.m. - 9:30 p.m.
Friday & Saturday: 11:00 a.m. - 10:30 p.m.
Sunday: 12:00 noon - 9:00 p.m.
- Delivery available all hours -
LEMON CHILL
WE ALSO HAVE CHERRY & STRAWBERRY CHILLS

Petals and Pearls
Says
"GO BIG LIONS!"
Order your MUMS and GARTERS early for best selection, best price, and for the chance to win your very own . . .

*** 38 in. Ozona Lion for Homecoming ***
Drawing for the BIG LION will be held Thursday, Sept. 15th, and the winner will be announced at the Ozona Lion Bonfire.
Call or Come by Today!
701 1st St.
(915) 392-3978



MEMBERS OF OZONA'S EXECUTIVE BOARD OF G.I. FORUM are: Emilio Tambunga, sergeant-at-arms; Frank Tambunga, treasurer; Henry Fay, secretary; Armando Robledo, vice-chairman; and Rico De Hoyos, chairman.



JESSE HERRERA, STATE CHAIRMAN, RICO DeHOYOS, OZONA'S CHAIRMAN, AND DOMINGA CORONADO, STATE EXECUTIVE SECRETARY of G.I. Forum at the charter presentation here Aug. 25.

Ozona's G.I. Forum Receives Charter

On Aug. 25 Ozona's G.I. Forum chapter received its official charter membership. After San Angelo's G.I. Forum chairman Pete Chappa led the meeting with the Pledge of Allegiance, all invited guests were treated to a buffet supper at El Chato's restaurant.

The evening's occasion was made a great success by the participation of a number of out-of-town guests. Assisting with the presentation of the charter were: Jesse Herrera, state chairman; Dominga Coronado, state executive secretary; Mr. and Mrs. George Santana, Region 6 chairpersons from Abilene; Pete Chappa, chairman from San Angelo; and Robert Gonzalez, Fort Stockton chairman.

Among Ozona's invited guests were: Rudy Matinez, Precinct 4 commissioner; Frank Tambunga, Precinct 1 commissioner; Orlando DeHoyos, county attorney; Raymond Borrego, county constable; and Sharon Farmer, Ozona Chamber of Commerce's manager. Other Ozona G.I. Forum members and invited guests included Chris Borrego, Laura and John DeHoyos, Nina Martinez, Irma Tambunga, Rosario Tambunga, Sister Jovita Perez, Father Ray Gallagher, Armando Fierro, Alda and Thomas DeHoyos, Sylvia Fay and Imelda Robledo.

A very pleasant surprise for the evening's activities included the presentation of the Outstanding Member Award to Rico DeHoyos, Ozona's G.I. Forum president. This award came after careful consideration of all G.I. Forum chapters in Texas. Also recognition was made of local executive board members: Armando Robledo, vice-chairman; Henry Fay, secretary; Frank Tambunga, treasurer; and Emilio Tambunga, sergeant-at-arms.

The G.I. Forum is a nonprofit organization which was founded by Dr. Hector Garcia of Corpus Christi. The purpose of the organization is to address the pressing needs of Mexi-

ELECTRIC SEWERooter

Clears CLOGGED PIPES, DRAINS, SEWERS No Digging - No Damage

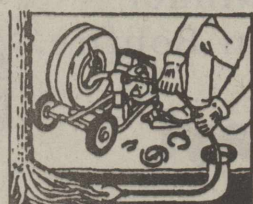

Raul De La Rosa
Plumbing
Service & Ditch Digging
Call 392-2726

* Lions (from pg. 1)

and Sonora recovered on their 20-yard line. On the third play with 5:15 minutes left in the game, Sonora's Morley threw a 79-yard touchdown pass play to Louis Massey. The extra point was no good, and the Broncos led 26-22.

Ozona tried their best to make it across the Broncos' goal line. Unfortunately, the Lions fumbled the ball, and Sonora recovered it on the Lion 43-yard line.

Coach Don Payne was pleased with the way the team played. With Chris Sanchez injured with an ankle problem, the secondary was not the same. Elliott Barrera also reinjured an ankle and several other players had to go both ways.

David Browne, Anthony Sanchez, Matthew Ortiz and Clay Westmoreland stepped up and played well as substitutes.

Ozona's defense did a great job making a total of 75 tackles and holding the Broncos to a total of 86 yards in the first half.

"Our defense played well, played hard and hustled to the ball," said Coach Payne. "Take away a few big plays, and we really held them. We were in key positions but didn't make the play."

The offense accumulated a total of 264 yards and 15 first downs. Jesse Garza caught 11 passes for a total of 173 yards.

"The offensive team did a good job," Payne added. "Jesse Garza was a clutch player and had an outstanding game."

The Lions will host the District 7-1A Sanderson Eagles for their homecoming game Sept. 16. Coach Payne says the Eagles play hard, get after it, and never seem to give in. Eagle players to look for include fullback Orion Patterson, quarterback-running backs Wess Billings and Efrain Gallegos.

The homecoming game will be at 8 p.m. on Friday. A spirit led homecoming bonfire will be held at 8 p.m. at the baseball park area on Thursday evening, Sept. 15. The pep rally will be held at 3:45 p.m. on Friday at Davidson Gym. Get out, have some fun and "Back the Lions".

Statistics

Ozona		Sonora
15	First Downs	12
36-83	Rushing Yds.	43-117
181	Passing Yds.	165
20-12-2	Comp/Att/Int	16-6-1
3-27.0	Punts/Avg.	5-28.0
6-4	Fumbles/Lost	2-1
3-18	Penalties/Yds.	8-70
Score by quarters:		
Ozona - 8, 7, 0, 7 - 22		
Sonora - 0, 6, 0, 20 - 26		

Museum Memorials

Mr. and Mrs. Pleas L. Childress in memory of George Kyle, Lee Graves, Joe Hubbard Crenwelge and Boyd Baker

Marilyn and Jim West in memory of George Kyle

Dorothy Millsbaugh in memory of Lee Graves

CHANGE IS GOOD

The main phone number for Union Pacific Oil & Gas Ozona Gas Processing Plant is **392-5581**

Our old phone number, 392-3071, is still a working number and is still the number for pipeline and other emergencies. Thanks to Ozona for your patience during this transition

Stop in and pick-up our new Gift Catalog

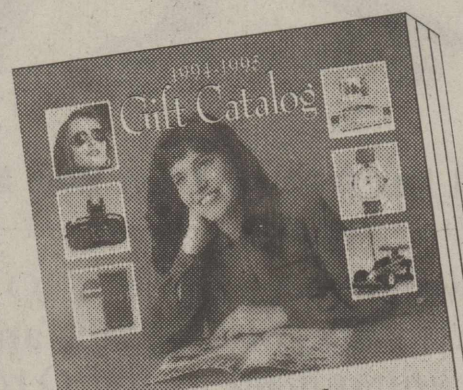

3,000 Gifts At Discount Prices

Get the worlds finest products... prompt, friendly, local service... discount prices and a full guarantee.

Village Drug
Village Shopping Center
392-2666

Woman's Group Opens New Club Year

The Ozona Woman's Forum began the new club year with a luncheon at the ranch home of Mr. and Mrs. Bill Carson Saturday, Sept. 10.

Assisting Mrs. Carson as hostesses were: Shirley Kirby, Katharine Russell, Willa Perry and Glenda Henderson.

Crystelle Childress gave an inspirational reading and led the group in prayer.

Following the luncheon under the beautiful shade trees, Marolyn Bean, president, opened the meeting by introducing new members Sue Cosper and Martha Gries and presented all members a recipe for a successful club. Shirley Kirby, vice-president,

passed out new yearbooks and reviewed upcoming programs, introducing Mrs. Bean's theme for the year, "Progressive Thinking Opens Doors".

Mrs. Bean conducted the business meeting with exciting plans for the year being discussed.

Those attending were: Jewel Bailey, Marolyn Bean, Jane Black, Louise Bunger, Norma Carson, Crystelle Childress, Geniece Childress, Sue Cosper, Martha Gries, Virginia Hubbard, Madye Jo Humphreys, Benny Gail Hunnicutt, Lu Ingram, Pauline Johnson.

Also Georgia Kirby, Shirley Kirby, Luetta Kost, Lucille Littleton, Marcille Long, Dorothy Montgom-

ery, Willa Perry, Betty Perry, Bernice Phillips, Katharine Russell, Madeline Stokes, Margaret Tabb, Blanche Walker and Helen White.

It's A Boy!

Keith and Tanya Olive are the proud parents of a new baby boy, Jacob Ross. Jake was born on Friday, the ninth of September, 1994, at 12:57 p.m. at Shannon Women and Children's Hospital in San Angelo. The baby weighed in at eight pounds, five ounces.

Proud grandparents are: William and Nancy Olive of Lexington, Charlie and Ann Flanagan of Del Rio and Zane McDonald of Sanderson.

CHECK OUT THE PLATEAU CELLULAR ADVANTAGE

AVAILABLE SERVICES

- Competitive Pricing Plans** - Pricing plans designed especially to meet your cellular communications and budget needs.
- Expanded Local Calling Scopes** - No long distance toll charges for calls from your home areas to the 915, 806 and 505 area codes.
- Custom Calling Features** - Call Waiting, Call Forwarding, Three Way Calling, Automatic Call Delivery, and Voice Mail Box Service all available.
- Network Of Authorized Agents** - Specially trained local agents to provide you with complete Plateau Cellular service.
- 6 Second Billing** - Six second billing at no extra charge. You pay for what you use.
- Detailed Billing** - Know exactly who you have called, when you have called and how long you have talked each month at no extra charge.

"REACHING A NEW LEVEL IN COMMUNICATION"

PLATEAU CELLULAR NETWORK

See these locally authorized Plateau Cellular Network Agents today for complete details.

John Henderson
312 Ave D
Ozona, TX
915-392-3503

or contact
Plateau Cellular Network
101 S. Betty
Monahans, TX
1-800-658-9577

O.L.P.H. Fall Festival

Dance

Music by

La Promesa Band

Saturday, Sept. 17, 1994

8:00 - 12 midnight

Advanced tickets - **\$8.00**
or **\$10.00 at the door**

Hamburgers and drinks sold during dance sponsored by Parish Council

Fall Festival Queen Contest

Queen crowning preceding dance

Candidates: Melissa Oveido, Stacey Ramos and Melonie Ybarra

Tardiada

Sunday, Sept. 18 - Music from 2 to 6

Food Booths

Hamburgers, corn on the cob, burritos and coliteas
Games for the children

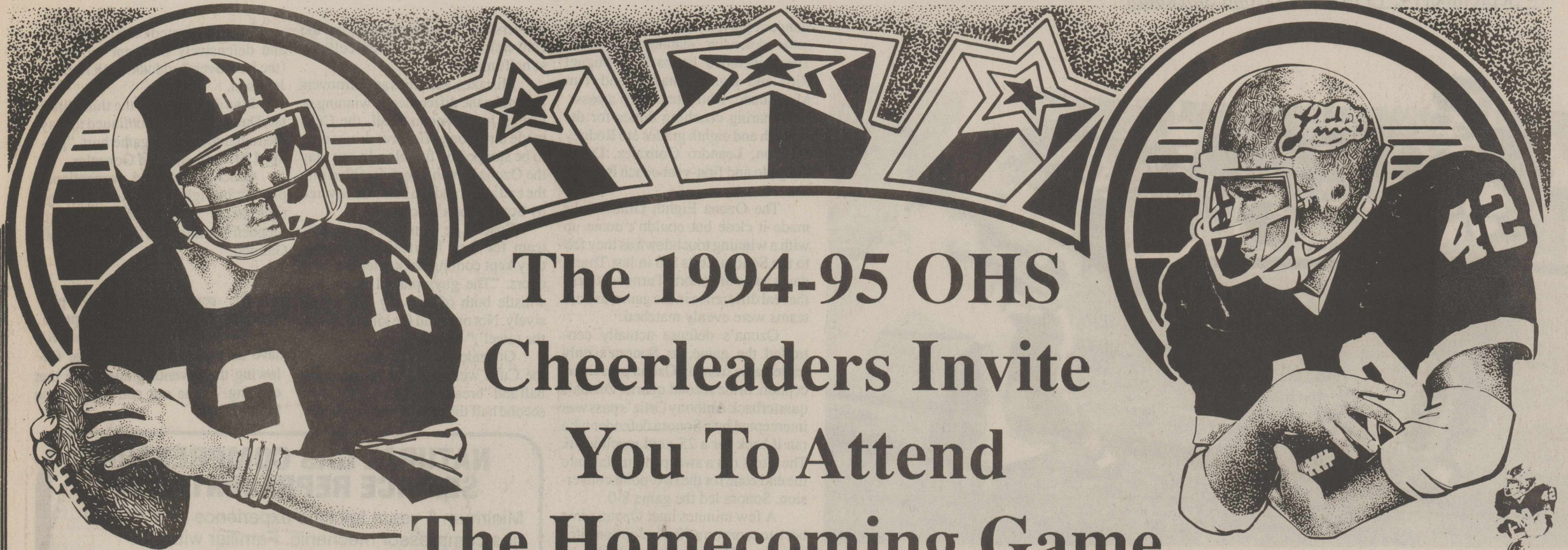

The 1994-95 OHS
 Cheerleaders Invite
 You To Attend
 The Homecoming Game
 And Activities
The Ozona Lions

VS

The Sanderson Eagles

Friday, 8:00 p.m. -- Lion Stadium



1994-95 OZONA HIGH SCHOOL CHEERLEADERS & MASCOT are (top) Mascot Connie Fielder; (bottom row) l-r: Gloria Pena-Alfaro, JoLynn Vannoy, Tara Wilkins, Leigh Chandler, Dana Bishop and Heather Hall. photo by Neal Ulmer

The Following Firms and Individuals are 100% Behind You

- | | | | |
|----------------------|------------------------------|------------------------------|---------------------------|
| The Baggett Agency | Bernard Rust D.D.S. | Brown Furniture | Bryan's Poco Taco |
| Cameras Two | Cecil Atkission | Circle Bar Cable T. V. | Circle Bar Motel |
| Comfort Inn | Crockett Automotive | Crockett County Natl. Bank | Dairy Queen |
| Daystop | De La Rosa Plumbing Ser. | El Chatos | Elma's Grocery |
| Family Affair | Fenton's Water Transport | Flying W. Lodge | Knox Floor Covering |
| Circle Bar 76 | Lone Star Video | Maness I-10 Texaco | Cafe Next Door |
| The Outpost | Ozona Butane | Ozona National Bank | Ozona Veterinary Clinic |
| OzonaWool & Mohair | Pepe's Cafe | Pioneer IV Oilfield Electric | Preddy Chevron |
| Preddy Funeral Home | Steve Sessom D.D.S. | and Wrecker Service | Shot's #2 |
| Shot's #4 | Small Fashions | South Texas Lumber | T & T Village Supermarket |
| The Teacher Store | Thorp's Laun-Dry | Village Drug | West Texas Utilities |
| Westerman Drug | Willconstruct | Wool Growers Central Storage | Troy Williams |
| Jim & Janet Wilson | Leo's Texaco | Baskets and More | R & L Bar-B-Q |
| T & C Village Market | Ulmer Photography | Ozona Sports & Supply | La Unica Tortilla Factory |
| Sutton Chevron | Triple G Supply & Roustabout | Hero's Pizza | Rye Supply |



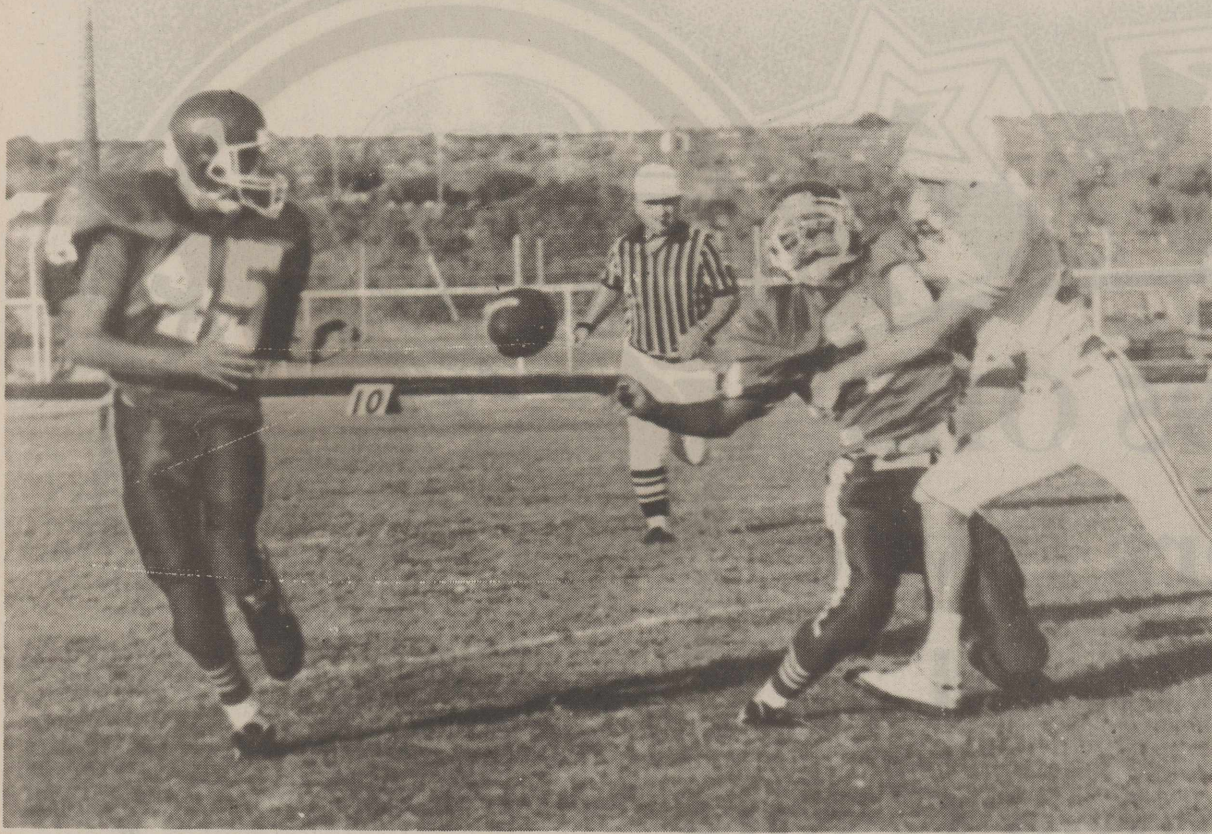

OZONA JUNIOR VARSITY LION quarterback #24 Pete Castaneda, as he is getting hit, pitches the ball out to Shayne Fuentes. Ozona lost 24-14 to Sonora in a Sept. 8 game in Lion Stadium. Photo by Neal Ulmer

Ozona Junior High Cubs Split Two With The Colts

By Neal Ulmer
Stockman Sportswriter

The Ozona Seventh and Eighth Grade Cubs traveled to Sonora Sept. 8 with high hopes of winning both games. The seventh grade Cubs mauled the Colts 22-0, and the eighth grade fought hard but lost 8-6.

The Ozona Seventh Grade team had difficulty scoring extra points, but they scored every other way. Tailback Matt Castaneda scored two of three touchdowns in the game. Fullback Miguel Rios scored one touchdown and ran for a two-point conversion.

In the first quarter of action, the Cubs scored on a 30-yard sweep play by Castaneda. The two-point conversion try failed due to an intercepted pass.

Also in the first quarter, the Cubs forced a fumble in Sonora's end zone on a punt attempt for an Ozona safety. At the end of the first quarter of play the Cubs led 8-0.

Through good defense, the Cubs were able to get the ball back quickly in the second quarter. The second touchdown of the evening resulted from a 10-yard run by Miguel Rios. A pass play for the two-point conversion failed, and at the end of the first half the Cubs led 14-0.

The Cubs added their last touchdown in the third quarter on a 35-yard run by Matt Castaneda, and Miguel Rios scored the two-point conversion on a quick pitch. Good defense by the Cubs held the Colts to a scoreless game, with the final score Ozona 22, Sonora 0.

Coach Rodney Johnson had high

praise for the Cubs, saying, "The team did a good job for their first game. There were very few penalties." "I was pleasantly surprised as to how aggressive the defense per-

formed," said Coach Leandro Gonzales. "I was extremely pleased by the way the team played, their tempo, and aggressive tackling." Besides the obvious offensive

Chamber Info

By Sharon Farmer

The Ozona Chamber of Commerce will sponsor a Halloween Carnival on Monday, Oct. 31, from 5:30 to 10 p.m.. The carnival will be in the downtown park. The chamber would like to invite all organizations to participate in providing the area children a safe and fun place to enjoy the fall event. Please call the office

392-3737, to reserve your spot for the event.

Retail merchants will start plans for the Christmas promotion at noon on Wednesday, Sept. 14, at the Hillcrest Restaurant. All interested in participating should be present or call the office for information.



Cafeteria Menu

Sept. 19... Cheeseburger, Salad, Tator Tots, Pear Half and Milk
Sept. 20... Baked Ham, Broccoli with Cheese Sauce, Corn, Rolls and Milk
Sept. 21... Chick Burger, Salad, French Fries, Jello and Milk
Sept. 22... Enchiladas, Pinto Beans, Salad, Cornbread and Milk
Sept. 23... Spanish Steak, Creamed Potatoes, Fruit, Rolls and Milk

Fast Food Menu

Sept. 19... Pizza, Salad, Tator Tots, Pear Half and Milk
Sept. 20... Ham & Cheese, Sandwich Salad, Tator Tots and Milk
Sept. 21... Barbeque on Bun, Pork & Beans, French Fries, Jello and Milk
Sept. 22... Chick Burger, Salad, Tator Tots and Milk
Sept. 23... Cheese Burger, Salad, French Fries and Milk

Breakfast Menu

Toast w/Jelly, Muffins, Cereal, Milk or Juice

standout players, both coaches noted some defensive standouts as well. These included linebackers Miguel Rios and Dustin Shaffer, and Tim Maldonado, who intercepted a pass.

Sharing coaching duties for the seventh and eighth grades are Rodney Johnson, Leandro Gonzales, David Delgado and first-year coach Richard Bachman.

The Ozona Eighth Grade Cubs made it close but couldn't come up with a winning touchdown as they fell to the Sonora Colts 8-6 in last Thursday's game in Sonora. Turnovers were the real difference in the game, as both teams were evenly matched.

Ozona's defense actually controlled the game, as Sonora's only score came from an Ozona pass interception. In the second quarter Ozona's quarterback Anthony Ortiz's pass was intercepted by a Sonora defender who ran it back for a 25-yard touchdown. The Colts ran a sweep-right play into the end zone for the two-point conversion. Sonora led the game 8-0.

A few minutes later Ozona came back to score on a 50-yard option pitch play from Ortiz to Matt Galindo. An Ozona penalty following the touchdown was assessed on the point-after

conversion. A running play on the conversion try failed, and the Colts led at halftime 8-6.

Mistakes, penalties and turnovers can make the difference in winning or losing. In the second half, the Cubs made three long offensive drives only to be stopped by fumbles. In one play the Ozona running back fumbled into the end zone, and the ball was covered by Sonora for a touchback.

Coach Lee Gonzales praised the team for their heartening efforts as they kept coming back after the turnovers. "The guys played to the last whistle both offensively and defensively. Not once did the kids 'throw in the towel'," he said.

Gonzales noted in the first half the Cubs were not able to move the ball and "break the big one", but in the second half they had three long drives.

"We dominated both offensively and defensively but kept turning it (the ball) over," added Coach Rodney Johnson.

Injuring his leg in the third quarter, David Gutierrez continued to play the remainder of the game hurt, "giving 110% effort," said Gonzales.

Coaches observed exceptional playing by right guard Robert Kelly, right tackle Dominguez, noseguard Stephen Martinez and linebacker Matt Galindo.

The seventh grade will play Mertz on at home Thursday, Sept. 15, at 5 p.m., and the eighth grade will have an intra-squad scrimmage following the seventh grade game that evening. Come out and support the future Lions.

NATURAL GAS COMPRESSOR SERVICE REPRESENTATIVE

Minimum 5 years full time experience as a natural gas compressor mechanic. Familiar with compressor maintenance/electrical controls, ability to troubleshoot and perform maintenance on natural gas compressors. Position located Ozona, TX area. Salary Negotiable. Send Resume in confidence to:

Human Resources Manager
KCI, Inc.
6105 West 68th Street
Tulsa, Oklahoma 74131



Equal Employment Opportunity M/F/H

Notice of REWARD

I AM OFFERING
\$500 REWARD

for apprehension and conviction of guilty parties to every theft of livestock in Crockett County - except that no officer of Crockett County may claim the reward.

Jim Wilson

SHERIFF, CROCKETT CO.

Just Thirty Days Remaining --

To register to vote or to transfer.

NOVEMBER 8

is ELECTION DAY

Voters will decide that day

WHO WILL BE,

for the next 4 years:

Governor of the State

U.S. Senator

And also, WHO WILL BE:

County Judge of Crockett County

Register, then talk to your neighbors and friends. Ask them,

WHO IS

TROY WILLIAMS?

They will tell you he is a successful businessman and rancher. He is a lawyer, a graduate of the University of Texas Law School. He is a square-shooter, and always works to help Ozona and Crockett County.

TROY WILLIAMS promises to work for the following:

- A Crockett County Disposal System, owned and operated by Crockett County.
- A 911 Emergency System.
- An Improved Airport.
- An Enlarged Nursing Home.
- A Senior Citizens Center.

TROY WILLIAMS

will use his influence to hold taxes down.

Pol. Adv. Pd. For By Troy Williams, Box 130, Ozona, TX 76943

NOTICE OF VOTE ON TAX RATE

THE CROCKETT COUNTY CONSOLIDATED COMMON SCHOOL DISTRICT CONDUCTED A PUBLIC HEARING TO INCREASE YOUR PROPERTY TAXES

BY 1.6 PERCENT

ON TUESDAY, SEPTEMBER 6, 1994.

THE CROCKETT COUNTY CONSOLIDATED COMMON SCHOOL DISTRICT OF BOARD TRUSTEES

IS SCHEDULED TO VOTE

ON THE TAX RATE AT A PUBLIC MEETING TO BE HELD ON

TUESDAY, SEPTEMBER 20, 1994,

AT 12:30 P.M.

AT THE SCHOOL ADMINISTRATION OFFICE

797 AVENUE D, OZONA, TEXAS

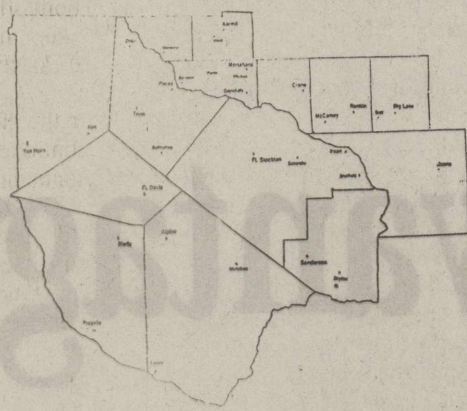

WestTex Advantage

Call (915) 392-2551 to put the WestTex Advantage to work for you.

Published in The Ozona Stockman, Rankin News, McCamey News, Iraan News, Big Lake Wildcat, Crane News, Pecos Enterprise, and the Monahans News.

Employment

D & V ROUSTABOUT SERVICE

Ozona and Sonora shops, need equipment operators, truck drivers with Class A CDL, experienced roustabouts. Must be able to pass DOT and drug screen. Serious inquiries only. 392-5678-Ozona, Sonora-387-5746. tfc46

NEEDED: Dishwashers and cooks now taking applications at Circle Bar. tfc23

PART-TIME secretary wanted for long-term job. Computer experience required. Honest, dependable. Call Bob or Ira. 392-2382. 4c28

HELP WANTED: Cook needed at Community Center, must be 18, have G.E.D. or high school diploma, pass a criminal history check. See Kay Baker at Community Center for application. No phone calls accepted. 1c31

CERTIFIED nurses aides needed at Crockett County Care Center. Apply in person during office hours with Honey Asis R.N.-B.S.N.-D.O.N. 1c31

COST FREE Christmas. Need 3 Christmas Around The World-House of Lloyd Demonstrators in this area. No investment. free Kit. Call (915) 884-3313 Gaye or 1-800-753-8216 Judy. Big Lake 1x31

WAITRESS needed at Longhorn Bar. 445-9379. Pecos 1x31

FUEL DESK cashiers, 3-11 and 11-7 shifts. Must apply in person at Flying J. Applications will be accepted until Monday 7 a.m.-5 p.m. Pecos 1x31

JAILER VACANCY - Crockett County Sheriff's Department is accepting Applications for the position of Jailer through 09-16-94. Salary starting at \$17,160 and raised to \$18,876 January 1, 1995. Applicant must be a citizen of United States; at least eighteen (18) years of age; a high school graduate or have passed a GED test, or have obtained the equivalent of twelve (12) Semester hours at an accredited college or university; not have been discharged from any military service under less than honorable conditions; not on probation for a criminal offense; not been convicted of a felony offense; not been convicted of a misdemeanor offense of a grade of "Class A" or its equivalent within the last twelve (12) months; not been convicted of a misdemeanor of the grade of "Class B" or its equivalent within the last six (6) months; not been convicted of the offense of Driving While Intoxicated or Driving Under the Influence of Drugs within the last two (2) years. Applicants should be of good moral character, be able to pass a background investigation and interview board. Successful applicants must pass a Psychological Evaluation, a Medical Examination and Drug Test. After employment, must complete a State certified Jail School within the first year of employment and pass the State License Examination. Applications can be picked up at the Crockett County Sheriff's Department in Ozona, Texas or by calling (915) 392-2661. Interviews will be conducted for two positions, one exists at this time and one position to be filled January 1, 1995. Crockett County is an Equal Opportunity Employer. 3c29

For Sale

PREDDY CHEVRON
Used tires for cars & light trucks
Used Truck Tires
392-2016 tfc34

QUALITY HANDCRAFTED Notions for the home * kitchen * family room * office * den and much more. Come see at Western Auto, 1104 Ave. E. tfc26

500 FT Sanisa Tower Space Available 15 mi. southwest of Ozona. excellent coverage in Crockett Co. and Sonora. Call Ira Childress and I'll save you money by never being out of touch. (915) 392-2382. 4c30

425 TXT LAP TOP color computer for sale. 392-5883-Rod Miller. Asking \$1800. 1p31

FOR SALE: Washer - \$100, dryer - \$75 (or both for \$150), electric stove - \$100. Call 392-2395. 1p31

'92 TITANIUM Ford Probe. 5-speed, 47,000 miles-\$9500. If you like driving, you'll love this car! 392-5008. By appointment please. 1p31

1993 FORD F-150 supercab. Texas-Okla. pkg. 15,200 miles - \$13,500. 392-5109. 2p31

1993 BUICK REGAL, four door sedan, AC, auto, tilt, cruise, manufacture warranty left-\$9,500. Ask for Shelby at 558-3537. Crane 1x31

1991 WT CHEVY CHEYENNE. 5-speed manual transmission. low miles, clean \$8,495. Ask for Shelby at 558-3537. Rankin 1x31

'69 CHEVELLE MALIBU 307-runs great. \$1,500. Call 558-2376. Crane 1x31

1982 REGENCY: \$3000. 943-5090, morning 8:30 till 11:30. Monahans 1x31

1976 F100 pickup 300, 6-cylinder, 3-speed, standard. No air. 20,000 miles, on complete new engine, extremely dependable. \$850. 547-2934. Monahans 1x31

FOR SALE: 1979 Mercury station-wagon, runs good. 943-8822. Monahans 1x31

FOR SALE: Lincoln Town Car in excellent condition. See at 212 West 14th. Monahans 1x31

FOR SALE: 1990 Golf Cart 943-2075. Monahans 1x31

FOR SALE: tandum dish, stock trailer, horse trailer. 547-2924. Monahans 1x31

#1 AND #2 ALFALFA by the bail or ton. 1-800-626-9894. Pecos 1x31

1970 CHEVELLE SS-396. Red and street ready. \$4,495. Call 447-2251, after 6. 447-6330. Pecos 1x31

Classified ads bring quick results when you have an item to sell or trade. Come by The Stockman to place your ad.

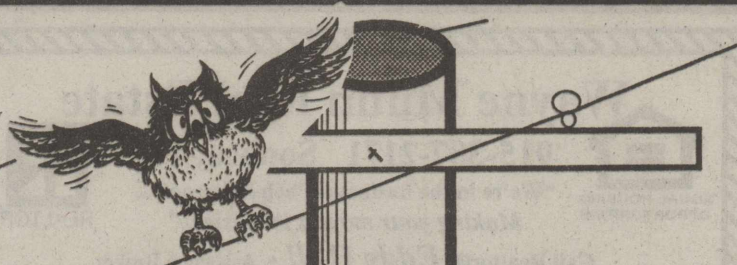

GARAGE SALES

GARAGE SALE: Large garage sale at Tite Bishop's House, appliances, dishes, clothes, odds and ends. Friday and Saturday, Aug. 16 and 17th. 8-? 1p31

GARAGE SALE: 1204 Peach Street, 8-? all day Thurs., Aug. 15th. Apt. refrigerator and misc. items. 1c31

GARAGE SALE: Sat., Sept. 17, 8-3 p.m. 106 Yucca Lane in the back. Luggage rack, car cover, lots of clothes and misc. 1c31

YARD SALE: Thurs., Sept. 15, 8-? 106 Ave. F, alley behind Petals & Pearls. Old truck, boat motor, bicycles, old stuff & lots of clothes & junk. 1c31

YARD SALE: 8-12, Sat., Sept. 17 at 408 Santa Rosa. 1c31

Nail your next garage sale sign in The Ozona Stockman-
The best read light pole in town!

Post no Bills!

THE HITCHIN' POST STEAKHOUSE AND CROCKETT CLUB
Good Steaks and Good Times

Luncheon Specials
QUICK, GOOD AND ECONOMICAL

Monday - Hot Steak Sandwich
Tuesday - Chicken Strips - all you can eat, all day
Wednesday - Steak Fingers - all you can eat, all day
Thursday - Marinated Steak Cubes
Friday - Hitchin' Post Fish Fry

Open until 10:30 p.m. Thurs., Fri. & Sat.
OPEN 7 DAYS A WEEK
1305 Sheffield Rd 392-5280

FALL IS UPON US!

We know it's still 90 degrees outside, but a cold spell is just around the corner
Time to check your coolant system

- Antifreeze • Belts • Hoses
- Thermostat • Radiator cap
- Water pumps

Come see us at
J. W. Motor Parts

- Tune-up Kits
- Mufflers
- Fuel System Parts
- Replacement Filters
- Blades
- And Much More

Lawnmowers, chainsaws, tillers, weeders, edgers

J.W. Motor Parts
516 9th St. 392-3734

Services

Large selection of wallpaper
KNOX FLOOR COVERING
201 Ave. I. 392-2180
Ozona, Texas

FOR YOUR RINSE/VAC CLEANER come to South Texas Lumber Co.

REESE HEATING AND AIR CONDITIONING: Service on all brands of refrigerated air-conditioners and heating units. Independent Lennox dealer. TACL-A000857. State licensed and bonded. Phone (915)836-4478.

Steve M. Sessom, D.D.S., P.C.
304 Ave. D-Box 1002
Ozona, TX 76943
(915) 392-2676
Mon., Tues. & Wed. OZONA
S.C.M.C.-Box 1217
Edinburg, TX 76936
(915) 853-2634
Thurs., Fri. ELDRADO tfc31

TV and VCR SERVICE
Satellite Sales and Service
902 Ave E
392-3256
Les's tfc20

ALCOHOLICS ANONYMOUS
meetings Monday nights at Lilly Construction, 8:00 p.m. Ph. 392-2054. 1f

Ozona Spraying Service
Webworms Fleas & Ticks
Pleas Childress
392-3103 tfc17

Fast Multi-color printing
The whole bowl of wax, plus Flyers
Ozona Stockman Press

DEADLINE
All news classified & display ads must be in our office by 5 p.m. Monday for publication in the Ozona Stockman on Wednesday.

---IF YOUR LOCAL NURSING HOME IS FULL---
The Lillian M. Hudspeth Nursing Home of Sonora has openings available for long - term care. For information please call Kathy Knight or Marilee Saegert, RN at (915) 387-2521

•Brush Control •Pitfencing •Backhoe •Roustabout

D & V ROUSTABOUT SERVICE
FULLY INSURED
24 HR. SERVICE
Radio Equipped

403 First St. Ozona, TX 76943
Office (915) 392-5678
Mobile 1-650-2452
1-650-2307 1-650-2308

COW POKES By Ace Reid

"Someday I'm gonna breed a type of horse that don't pitch on cold frosty mornings."

When is the best time to check on your Fire & Casualty Insurance? **NOW!**
Jack Baggett, Jr. will answer all of your questions!

The Baggett Agency
392-2606 1114 Ave. E

Ozona Butane
Propane Sales and Service
392-3724

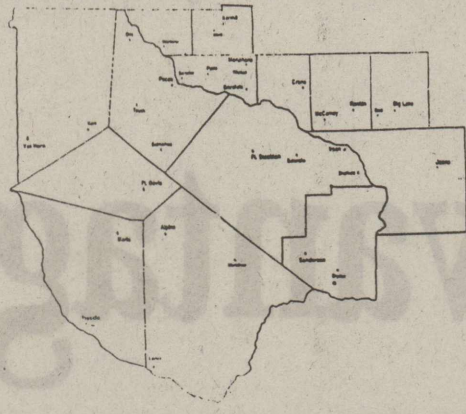

WestTex Advantage

Call (915) 392-2551 to put the WestTex Advantage to work for you.

Published in The Ozona Stockman, Rankin News, McCamey News, Iraan News, Big Lake Wildcat, Crane News, Pecos Enterprise, and the Monahans News.

Real Estate

NICE LOTS FOR SALE
In Country Estates Addition
Some deed restrictions apply

HOMES

PECAN TREES

Shade this nice
3 bdrm brick home
at 1107 Owens St.
\$44,000

2 LOTS

for sale
as a unit
in Crockett Heights
\$15,000

SPACIOUS TWO-STORY

TRADITIONAL HOME
with formal living and dining
rooms, 4 bdrm, 2 ba., den, break-
fast room, laundry room, intercom,
2 car garage
1104 Ave. C
\$112,000

CHARMING VINTAGE HOME

In nice location - 4 bdr., 3 ba.,
new roof - 301 11th Street
\$92,600

LARGE LOT, PECAN TREES

screened-in porch, even a
basement. 3 bdr., 1 ba. home
7 Eleventh St.
\$62,500
\$59,500

AFFORDABLE HOME

with fenced lot on 65' x 75' plot
adjacent to IH-10
Priced right at **\$29,900**
124 Mariana St.

THREE BDR. ROCK HOME

on 200' deep lot - priced right at
\$59,900

HILLTOP LOCATION

3 bdr., 2 ba. w/ nice yard
and extras, extras, extras!
Pool, RV shelter, shop, storage,
sprinkler system on 3 large lots
1101 RATLIFF
\$82,400

1+ ACRE

COMMERCIAL LOT
FOR LEASE OR RENT
(or will build to suit tenant)

FOR SALE

Chandlerdale West Lots
Owner Financed

Childress Real Estate

392-3634

3 BDRM., 1 ba. CH/A, #30 Crockett

Heights. Nice shade trees and attached
workshop. \$30,000. Call Terry Criner.
653-5065 or 468-5200. tfc26

FOR SALE: Custom 3 bedroom brick

home, extra nice. 104 Lena Drive.
Call 558-2097 or 558-2403. Crane
1x31

FOR SALE BY OWNER: 3 bed-

room, 1 bath home across from high
school gym and band hall. Remod-
eled, modern kitchen with all appli-
ances included. New dishwasher,
fairly new central heat and refriger-
ated air, ceiling fans in bedrooms.
Nice patio, landscaped yard, cement
slab to accommodate large storage
building. Cinder block fence around
large back yard. Please call 558-3825.
Crane 1x31

FOR SALE OR LEASE: 3 bedroom,

1 bath house. Call for appointment 1-
367-6767. 1102 S. Elizabeth. Crane
1x31

FOR SALE: 3 bedroom, 1 1/2 bath

on large lot across from school. New
paint, new roof, new fence. 1000
Upton. \$9,800. Call 693-2327 after 6
p.m. Rankin 1x31

FOR SALE: 3-bedroom house, 902
Severn, \$22,500, storage building,
stove, refrigerator, dishwasher, old
lawn mower. 915-363-8641. Rankin
1x31

FOR SALE: Big brick house,
\$65,000, 502 Kilborn, 4 bedroom, 2
full bath, den, livingroom with fire-
place, dining room, kitchen, utility
room, big patio with big back yard,
storage house, water well. Call 693-
2390 for more info. Rankin 1x31

BRICK, 4 br., 2 ba., 2 car gar., strg.
bldg. 915-363-9220. Pecos 1x31

7 YR. OLD HOME on 2 lots. 3
bdrm., 2 ba., 2 lvng. areas, C/A/H.
\$230/mo. 445-4879 after 6 p.m. Pecos
1x31

3 BDRM HOME with 2 baths, C/H/
A, two car garage, storage building,
rear entry garage and hot tub room.
Fireplace with gas starter, beautiful
yard with sprinkler system. \$65,000
or \$9000 equity & take up payments.
Call 447-9563. Pecos 1x31

Acreage

.581 ACRE OF LAND for sale.
Undeveloped plot located north of
Crane Realty Mini Storage. For more
info, call 697-5893. If no answer, leave
message. Crane 1x31

FOR SALE: Lot on Kilborn St., \$500.
Nice house for \$18,000 504 Kilborn
St., 2 bdrm, 1 bath, living room, den/
fireplace, dining room, kitchen, utility
room, big back yard. 693-23290
for more info. Rankin 1x31

Pets & Supplies

THE DOG PATCH
Grooming shop, baths, dip and clip.
392-3415-Carol Cook and leave
message. 392-5467-Sheryl Pollard.
Monday-Thursday 9 to 5, Ave. J.
4p31

Business Opportunity

OWN YOUR OWN Apparel or Shoe
Store, choose: jean/sportswear, brid-
al, lingerie, westernwear, ladies,
men's, large sizes, infant/preteen,
petite, dancewear/aerobic maternity,
or accessories store. Over 2000 name
brands. \$24,900 to \$36,900: inven-
tory, training, fixtures, grand open-
ing, etc. Can open 15 days. Mr. Lough-
lin (612) 888-6555. 1p31

For Rent

COUNTRY CLUB APART-
MENTS for rent. 2 bedrooms. Call
392-3362.

OFFICE SPACE, also building for
lease in shopping center. Call J. B.
Miller at Firestone, 392-2641. tfc14

TOWN HOMES for lease at Coun-
try Club Estates. Available Jan. 1.
Call or 214-732-6554. tfc26

Wayne Munn Real Estate
915-387-2171 Sonora, TX
"We're in the business of helping people...
Making your move a lot easier!"
Call Realtor® **Eddy Hall** - Associate Broker

Ozona Office (After five p.m. and on weekends): 915-392-3916

Larger than it looks! 4 BR, 2 B, CH - CA, lg. lot - garage w/ storage
1112 Eleventh St. - \$49,500

Lots of room - 4 bdr., 2 ba., lr., extra large kitchen & den, patio,
double carport, 5 ft. pipe fence w/pens, 2 storage bldgs. - 402 Terrace

Many possibilities with this supersize shop w/ office.
Plus house w/ 4 br, 2 1/2 ba., LR, DR Kit. combo
and lg. laundry room - \$40,000 - 201 Ave. J

Swimming pool outside, Jacuzzi inside! 4 BR, 2 BA, Lr, Dr,
gameroom, basement, slate roof, plus 2 storage bldgs. Also
includes extra large corner lot behind the house.
904 Ave. F - Shown by appt. only

Quaint 3 br., 2 ba., cedar siding w/ metal roof, patio
& lg. carport, newly remodeled kitchen - 610 Coates
SHOWN BY APPT. ONLY

NEEDED:
LOCAL ORGANIZATIONS INTERESTED
IN PROVIDING GAMES AND BOOTHS FOR
HALLOWEEN CARNIVAL. CALL OZONA
CHAMBER OF COMMERCE.
392-3737

Miscellaneous

KOMECHAK KRITTER Sitter
Service and Dog Grooming, Bath,
Dip and/or Clip. Cindy Reavis
Komechak RVT, 392-3304. tfc20

KOMECHAK WELL Service,
Windmills, Submersible Pumps, Pres-
sure Systems, 392-3304. tfc7

Mobile Homes

NEW 16 X 80 3 Br, 2 BA mobile
home, \$18,888.00. Call 1-800-618-
9629. 26c26

WE PAY CASH for used mobile
homes. Call 1-800-618-9629.
26c26

ABANDONED 3 br, 2 bath double
wide. Make up back payments Call 1-
800-618-9629. 26c26

Lost & Found

DALMATIAN FOUND: Call 392-
5240 or 392-5677 after 5 p.m.
1p31

LOST - set of keys during the David
Crockett Days. If found, return to
Ozona Stockman. 1p31

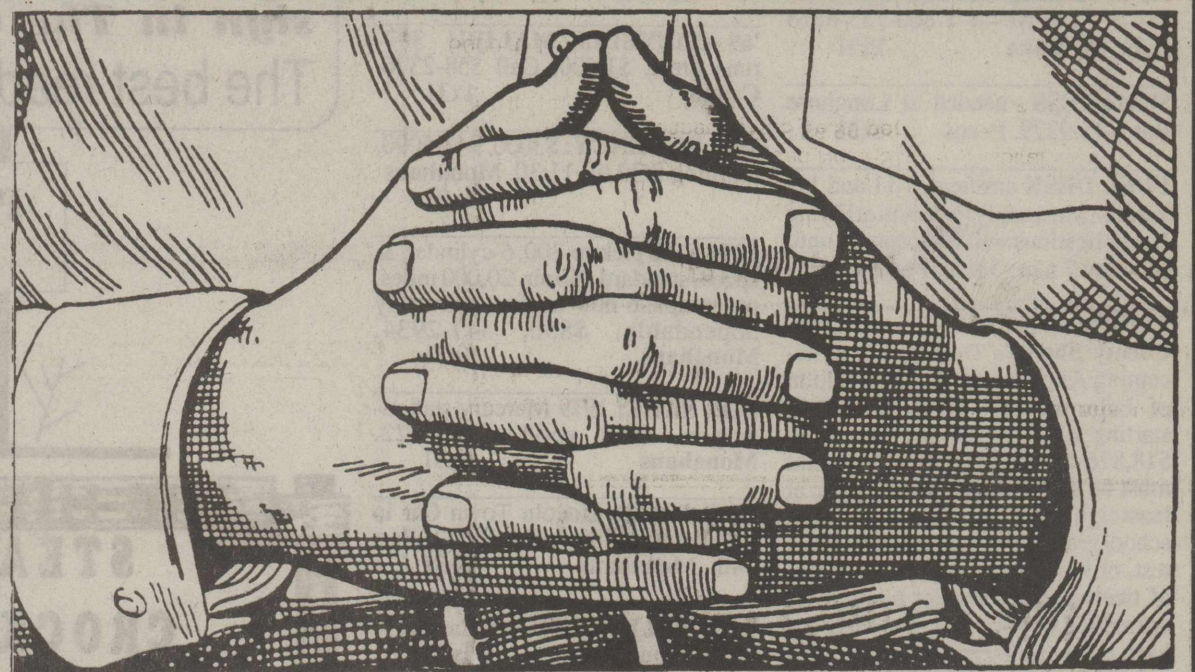

**When you're in the market for
a new car, we can help.**

**When you apply for
your auto loan, in
most cases we'll
give you an answer
on the very same
day.**

**Take Advantage
of Our
Auto Loans**

**Sound like a great
deal? It is, and all
it takes is just a
phone call or visit
to us.**

Attention Investors:

Special **FREE** seminar on
"Tax Deferred Investing"
by Investment Professionals.
Tuesday, September 27th, 1994
6:00 p.m. - Crockett Room
If interested call Lou Anna at 392-2346

Brokerage investments are not obligations of the bank,
are not guaranteed by the bank, are not insured by FDIC
and their value will vary with market conditions.

Ozona National Bank



Ozona
(915) 392-5545

Established 1905
Member FDIC



Wimberley
(512) 847-2253

P.O. Box 430, Ozona, Texas 76943

Se Habla
Español

COMPLETE SMALL ENGINE REPAIR SERVICE

Tune-Ups • Repair • Overhauls

WE REPAIR LAWN MOWERS & SMALL ENGINES

Offering prompt, courteous service on your 2-cycle or 4-cycle engine.

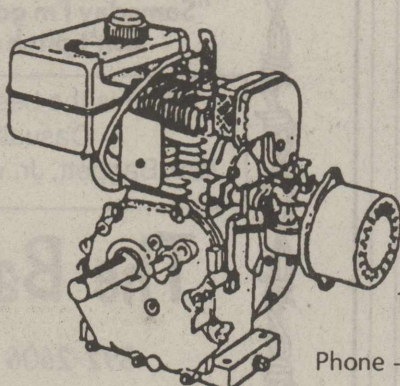

**Perry
Motors,
Inc.**

1201 Ave. J • P.O. Drawer 1800
Ozona, Texas 76943
Phone - (915) 392-3680 - 392-2029

Major Credit Cards Accepted

Fax - (915) 392-3735