

CROCKETT CO. PUBLIC LIB.
BOX 3030
OZONA, TX 76943

3000 SQUARE MILES
CROCKETT COUNTY
LIVESTOCK TERRITORY

THE OZONA STOCKMAN

And the Crockett County News

"Out In The West, Where The Air Is Pure, The Climate Agreeable, And The People Friendly --- The Best Place On Earth To Call Home."

Volume 77 Number 42 Wednesday, December 6, 1989 Ozona, Crockett County, Texas 76943 USPS 4168-2000 30¢ per copy

2nd annual Deer Fest Friday night

Ozona's second annual Deer Fest, scheduled for Friday night, Dec. 8, features a tempting game meal and thousands of dollars worth of prizes. Wild game such as elk, venison, dove, turkey and pig will be cooked at the civic center by local chefs. Potato salad, beans and dessert round out the meal to be served beginning at 6:30 p.m.

Admission tickets to the Deer Fest are \$5.00 and may be purchased at the door, the Ozona Chamber of Commerce office or from chamber members.

As many as 500 people from Ozona

and surrounding towns are expected according to Steve Williams, chamber president.

Several surprises are in store during the entertainment portion of the evening, Williams said. Jim House will act as master of ceremonies.

Included in the list of prizes are 25

rifles and a barbecue pit.

Tickets which have been stamped at the Deer Fest are good for a discount at all Ozona motels and most restaurants. Presentation of the ticket at a participating business is all that is necessary to receive the discount, Williams said.

Christmas Concert to be presented Fri., Dec. 15

The Midland-Odesa Symphony & Chorale Pops Orchestra and Chorale will be in Ozona Dec. 15 to perform a Christmas concert at Ozona High School Auditorium.

Pre-concert tickets are on sale at \$5.00 for adults and \$3.50 for students. Cost of tickets at the door will be \$6.00 for adults and \$4.00 for children. The tickets are available at Crockett County Museum, Ozona National Bank, Crockett County National Bank, The Ozona Stockman, The Teacher Store, Ozona Chamber of Commerce and Margie's Beauty Shop.

The Pops Orchestra is comprised of 55-60 professional musicians.

The concert will be performed at 7 p.m.

The program for the Holiday Pops

concert includes: Evening Prayer and Dream Pantomime from Hansel and Gretel by Humperdinck, Fantasia on Greensleeves by Vaughan-Williams, Quoniam to solus Sanctus: Cum Sancto Spiritu, from "Gloria" by Vivaldi, His Yoke is Easy from "Messiah" by Handel, Suscepit Israel; Sicut locutus est; Gloria, from "Magnificat" by Bach

Sleigh Ride by Delius, Sleigh Ride by Mozart, Sleigh Ride by Anderson, The Many Moods of Christmas arranged by Shaw and Bennett Suite II - O Sanctissima, Joy to the World, Away in a Manger, Fum, Fum, Fum and March of the Kings, and Suite III with What Child is This, Hark! the Herald Angels Sing, Bring a Torch, Jeanette, Isabella, and Angels we Have Heard on High.

OHS hosts 59th Annual Basketball Tournament

The 59th Annual Ozona Basketball Tournament will be held Friday and Saturday. Boys' teams from Clyde, Coahoma, Junction, Brownfield, San Angelo J.V. and Reagan County, and the Ozona varsity and J.V. teams will compete.

The girls' varsity team will participate in a round robin event. Visiting teams will be from Crane, Clyde and Junction. In this event, all teams will ultimately play one another. The winner will be decided using total statistics taken throughout the contest.

The Ozona girls will be the first to play with a 10 a.m. Friday game against Junction.

Boys' varsity action will begin at 1 p.m. Friday when the Ozona Lions pair up against Clyde.

For additional schedule information, consult the bracket on the basketball page.

Vannoy advances to state food show

Crockett County 4-H members walked away with several top honors at Saturday's District VI 4-H Food Show, including Whitney Vannoy's first place in the senior fruits and vegetables category.

Whitney, the daughter of Dr. and Mrs. Gary Vannoy, is a 7-year member of Crockett County 4-H and a freshman at Ozona High School. She

will compete for a \$750 scholarship against 4-H members from 14 other Extension districts at the State 4-H Food Show on the Texas A&M campus in June.

In addition to a plaque furnished by Morrison Milling Company, Whitney received a \$50 bond from West Texas Utilities Company.

JoLynn Vannoy also took honors Saturday as the first-ever winner of the district's new beef award. The \$100 savings bond is sponsored by the West of the Pecos Cattlewomen's Association. JoLynn also received a \$50 bond for winning her intermediate main dish category.

She is a 5-year member of Crockett County 4-H Club and is in the 7th grade at Ozona Junior High School.

Another 7th grader at OJHS, Courtney Phillips, daughter of Woody and Debbie Phillips, won second place in the intermediate fruits and vegetables category, and received a silver tray.

Jennifer Davidson, daughter of Mr. and Mrs. C. E. Davidson IV, and Leana Baggett, daughter of Mr. and Mrs. Penn Baggett, both took third place in their respective categories, senior nutritious snacks and desserts and junior main dish. They each received a 4-H recipe box.

4-H members from Crockett County who received blue ribbons were Tres Bailey, son of Paula Bailey and Jim

Workshop draws county officials

Six local officials attended a fall regional workshop for county officials at Fort Stockton Nov. 30. This was a regional program addressing issues of common interest to all Texas county officials.

Attending from Crockett County were: County Judge Kathryn Mayfield, County Commissioners Sostenes DeHoyos and Janet Hill, County Attorney Orlando DeHoyos, County Agent Billy Reagor and Sheriff Jim Wilson.

Topics covered were an overview

of the criminal justice reform legislation, risk management, and an update on recent legislation.

More than 90 officials from the area attended. Speakers were from the State Comptroller's office, the Attorney General's office, the Texas Adult Probation Commission and the Texas Association of Counties.

The workshop was co-sponsored by the Texas Association of Counties and the V.G. Young Institute of County Government of the Texas Agricultural Extension Service.

Constables attend school

Forty-nine constables, their deputies and clerks attended a 20-hour Basic Civil Process School Oct. 31-Nov. 2 in San Angelo conducted by the Texas Justice Court Training center, headquartered at Southwest Texas State University in San Marcos. Topics covered included citations, liability, executions, possessions, garnishment, protective orders,

sequestration and attachment, community relations, financial management, order of sale and the Texas Commission on Law Enforcement Officers Standards and Education.

Constable Raymond P. Borrego of Crockett County was one of the 49 attending the school.

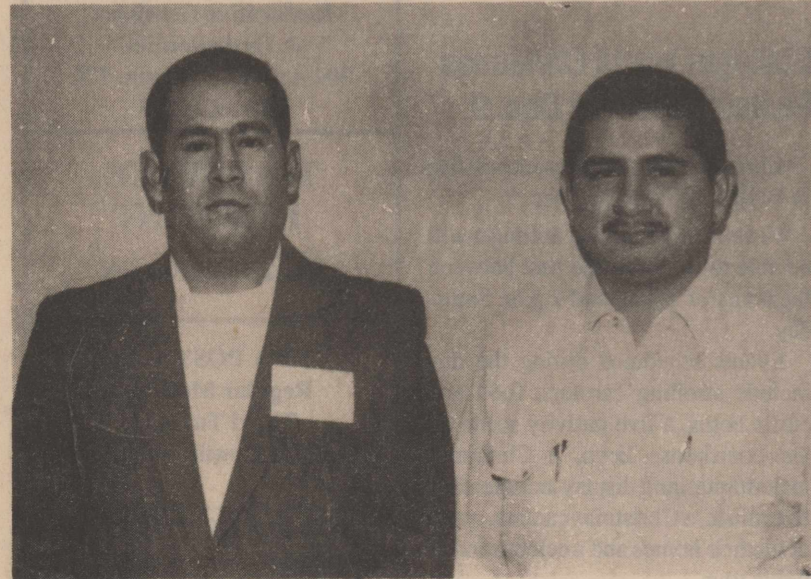

Constable Raymond P. Borrego (r) of Ozona and Constable Reynaldo Ramirez of Edwards County recently attended Basic Civil Process School in San Angelo.

Puckett announces for office



I would like to announce my candidacy for the office of District and County Clerk of Crockett County. I am the incumbent and have been in office for the past six years. Prior to my appointment in 1983, I served in the capacity as Chief Deputy Clerk



The seventh grade Cubs won their tournament this past week. Team members are: (left to rt.) (24) Tony Valencia, (25) J.J. Lozano, (12) Jesse Garza, (50) Doug Meador, Joe Esparza, (10) James Nelson, (11) Chris Sanchez and (23) Anthony Sanchez. photo by Neal Ulmer



The seventh grade Cubettes proved victorious in their tournament last week. Pictured are (front row, left to right) (10) Gloria Peña Alfaro, (21) Kelli Gentry, (20) Leigh Chandler and (22) Tanya Coker. Back row: (23) JoLynn Vannoy, (13) Melissa Porras, (42) Connie Fielder, (14) Courtney Phillips, (15) Manuelita Quiroz and (25) Jeri Lynn Tucker.

Bob Bailey, and Robin Conner, daughter of Mr. and Mrs. T. C. Conner. Red ribbon recipients were Julie Childress, daughter of Mr. and Mrs. Pleas Childress III, and Sara Mayfield, daughter of Mr. and Mrs. Richard Mayfield. White ribbon recipients were Jennifer Jones, daughter of Mr. and Mrs. Woody Phillips, and Nancy Arrott, daughter of Mr. and Mrs. Jimmy Arrott.

Accompanying the 4-H members to the food show were Tedra Ulmer, County Extension Agent-Home Economics, Sadie Davidson, Sandra Childress, Shelley and T. C. Conner, Lara Sue and Penn Baggett, Nancy Vannoy, Debbie Arrott, Debbie Phillips, Kathy and Martha Mayfield,

(Continued on pg. 11)

Mayfield announces for re-election



Kathryn Mayfield announced her candidacy for re-election as Crockett County Judge, subject to the March Democratic Primary.

The complexity of issues confronting county government can be attested to by the hours spent by our active commissioners' court. We now meet two times a month and rarely finish by noon. Both the state and federal government are mandating more and more rules and regulations without providing any funds for implementing or conforming to them. This is what is happening with the Environmental Protection Agency and landfills, more red tape for hospitals, and now community correction facilities. I pledge that I will continue to work hard to stay current with these mandates and seek to make our state and federal representatives aware and more sensitive to our needs. I am currently active as secretary/treasurer of the Far West Texas Judges and Commissioners Assn. and will continue to seek recognition for Crockett County.

Our county criminal court is very

active with the December docket listing 53 cases. The majority of these cases are new cases with less than ten being more than a year old. Our judicial system is working with all involved working together. More than one-half of our dockets deal with driving while intoxicated offenses that without an attorney for County Judge would either overload the district court or risk being invalid judgments.

I respectfully solicit your continued support in the Democratic March Primary.

Pol. Adv. Pd. For by Kathryn Mayfield, P. O. Drawer 2096, Ozona, TX 76943

The Weather

THE NATIONAL WEATHER SERVICE
Compiled by James Pagan

	Hi	Lo	Rain
Nov. 28	50	38	
29	48	34	.26"
Dec. 1	41	35	.04"
2	45	31	
3	50	42	
4	56	38	

Total rainfall for year: 11.19"

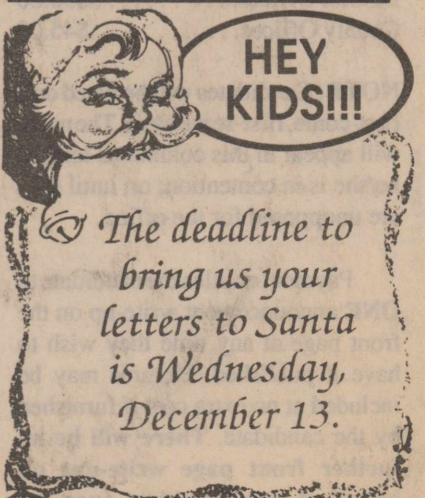

The deadline to bring us your letters to Santa is Wednesday, December 13.

3000 SQUARE MILES
 CROCKETT COUNTY
 OF
 LIVESTOCK TERRITORY

The Ozona Stockman
 and the Crockett County News

"The Ozona Stockman (USPS-416-820) is published weekly for \$14.00 per year in Crockett County and \$16.00 per year elsewhere by Mr. and Mrs. John S. Moore, 1000 Ave. E, Ozona, Texas 76943-0370. Second class postage paid at Ozona, Texas 76943. POSTMASTER: send address changes to THE OZONA STOCKMAN, P.O. Box 370, Ozona, TX 76943-0370."

MR. & MRS. JOHN S. MOORE - Publishers
 LINDA MOORE - Editor
 SUSAN SHEPPARD - Photographer, Ad Production
 BETH BOYD - Advertising Sales
 JON MORAN - Pressroom Foreman
 J. L. TUCKER-Sports
 MICHAEL VASQUEZ-Sports

Published weekly since 1913 and entered as second class matter April 9, 1913, at the Post Office at Ozona, Texas, under the Act of Congress of March 3, 1879. Published each Wednesday.

Notices of church entertainments where admission is charged, card of thanks, resolutions of respect and all matter not news, will be charged for at regular advertising rates.

Any erroneous reflection upon the character of any person or firm appearing in these columns will be gladly and promptly corrected if called to the attention of the management.

CLASSIFIED RATES - 15 cents per word. Minimum charge \$2.50 per insertion

TELEPHONE (915) 392-2551
 ADDRESS - 1000 Avenue E.
 P.O. Box 370, Ozona, TX

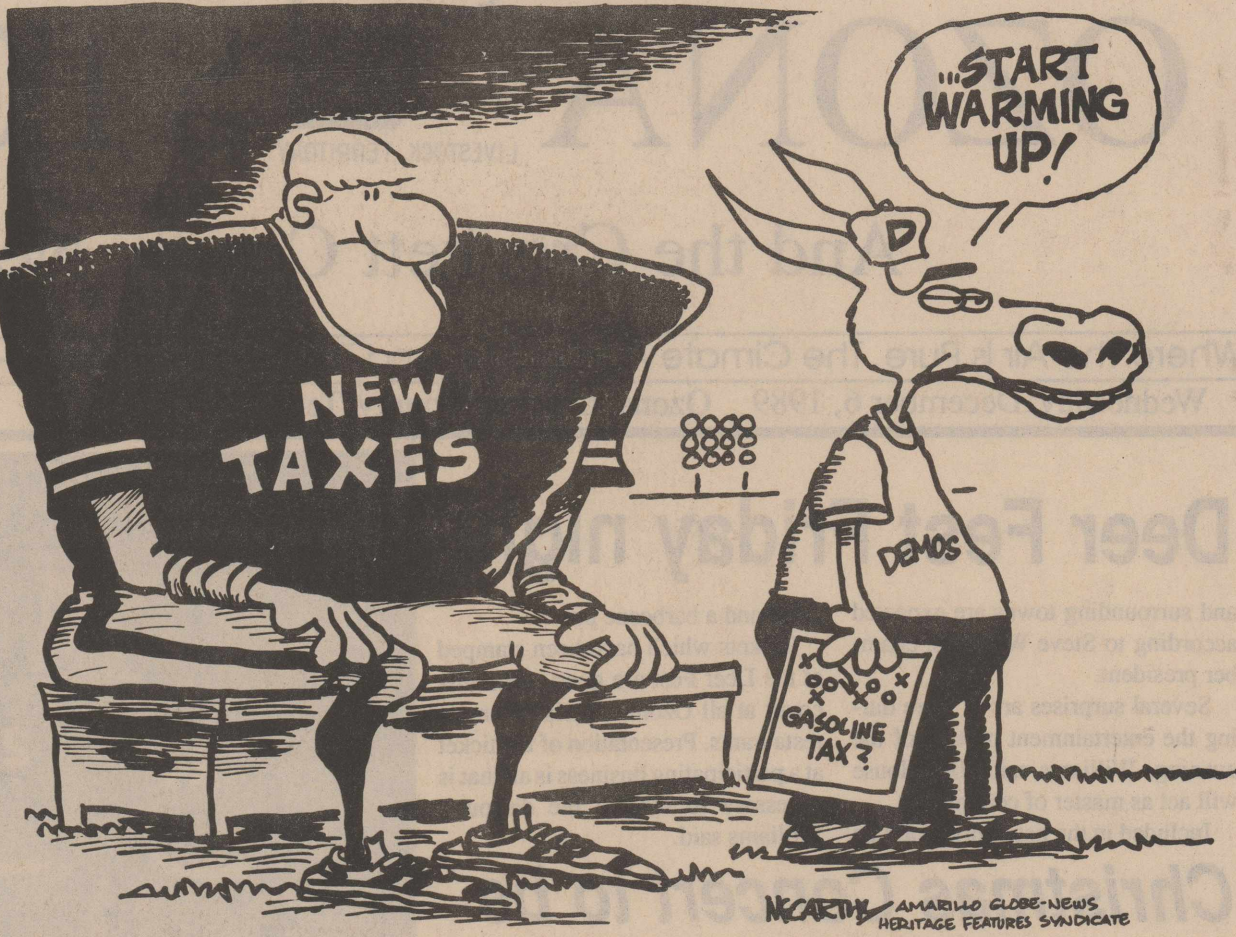

The Newsreel

A rerun of "The Ozona Story" as gleaned from the files of The Ozona Stockman

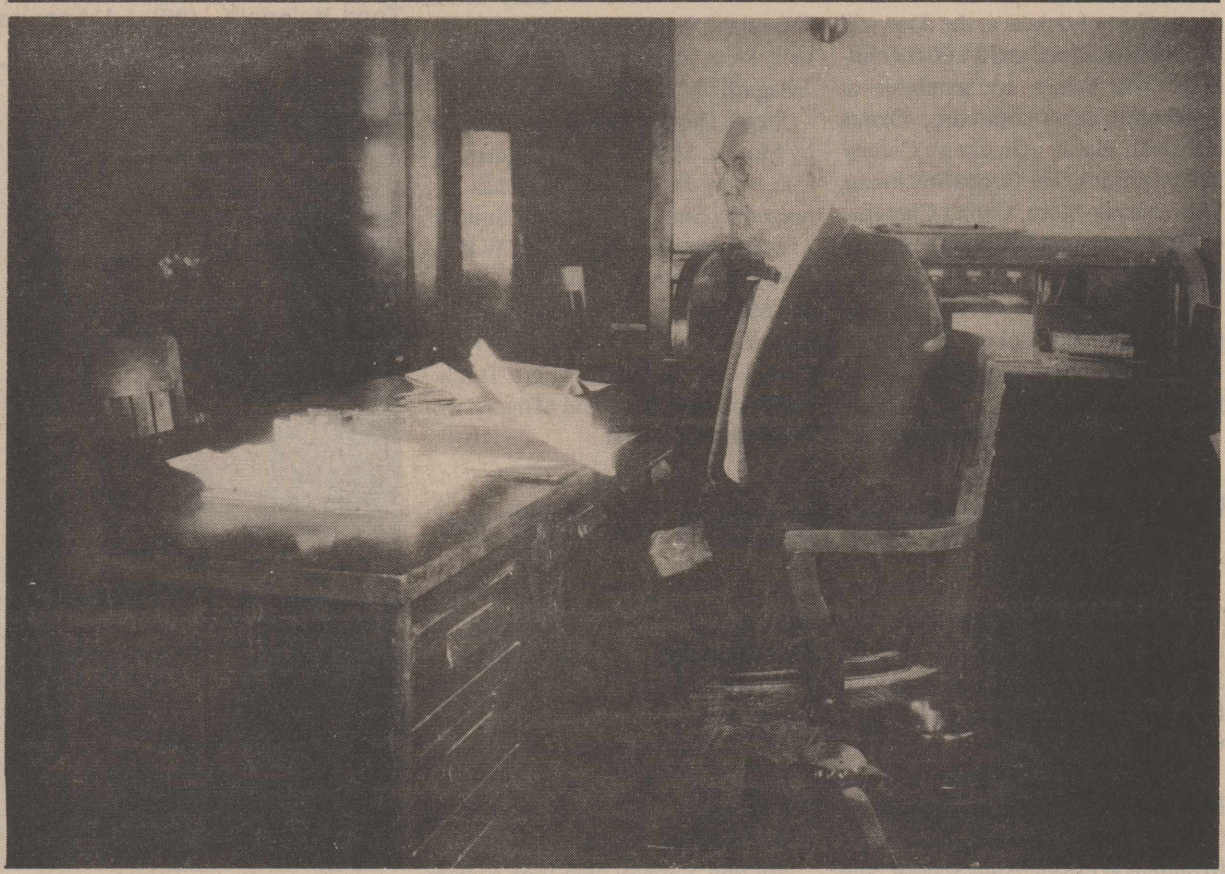

To add interest to the weekly "Newsreel" column, an old picture will be printed here every week. Identities of subjects are not known. If you recognize anyone shown here, please notify The Ozona Stockman so that the information may be printed in next week's paper.

Business & Professional Guide

PERRY MOTORS, INC
 Auto - Truck Gas - Diesel
 Mechanics
 24 Hour Wrecker - Storage
 24 Hour Phone 392-5511
 #1 Barnhart Hwy. - Ozona

J.W. MOTOR PARTS
 Auto Parts & Supplies
 516 9th Street 392-3734

PLANNED PARENTHOOD
 of the Concho Valley
 1-800-237-2162
 Free transportation services

HELPING HANDS
SENIOR CITIZENS CENTER
 903 Twelfth St.
 392-5026

HOUSE FUEL COMPANY
 Wholesale Fuel and Oil
 103 Ave. E.
 392-3010

CROCKETT COUNTY
MUSEUM
 Mon. - Fri. 1-5 p.m.
 For special tours, call 392-2837
 392-2123 392-5240

OZONA BUTANE CO.
 Propane Gas - Sales & Service
 Hwy. 163 S.
 392-3724

BROWN FURNITURE CO.
 ACCESSORIES • GIFTS
 • MIRRORS • LAMPS •
 • CARPET • WALLPAPER •
 • DRAPERY • BLINDS •
 • BED & BATH •
 • GOURMET •
 • APPLIANCES •
 906 AVE. E. 515 11th

VISA DISCOVER MasterCard

THIS SPACE FOR RENT
\$2.50 per week

OLSON
LAWN MOWER REPAIR
 Minor Tuneups
 Complete Overhaul
 Monday thru Saturday
 608 Ave. G. 392-2220

BORREGOS SERVICE DEPT.
 705 11th Street
 Car Service Minor Repairs
 Shocks Mufflers Brakes
 Wash & Lube
 Shop-392-5022 Home-392-3674

"LILLIE'S BEAUTY SHOP"
 Perms, sets, haircuts,
 colors, sunglitz, frost
 and all latest styles
 Call 392-3536 • Mon. - Sat.
 1108 Beall St.

DAVEE
PLUMBING & ELECTRIC
 Sales & Service
 Ditching
 (915) 392-5888

B & C AUTOMOTIVE
 Complete Auto Repair &
 Auto Needs
 403 First Street
 392-2016

FIRST BAPTIST CHURCH
 Sunday School 9:45
 Morning Worship 11:00
 Evening Worship 7:00
 Prayer Service Wed. 7:30

S.M. SESSOM D.D.S.
 Restorative Dentistry
 & Orthodontics
 304 Ave. D. Ozona, TX
 915-392-2575

THIS SPACE FOR RENT
\$2.50 per week

VFW POST 6109
 Regular Meetings
 Third Tuesday
 In Each Month - 8:00 p.m.

KNOX FLOOR COVERING

VISA MasterCard

201 AVE. I. 392-2180
 OZONA, TEXAS

Deadline for information to be included in the community calendar is 5 p.m. on Monday.

Community Calendar

- Dec. 6
 Junior High Book Fair Continues Through Dec. 8
 Junior High Photo Retakes
 West Texas Singles Armchair Videos 7 p.m. 392-3891
- Dec. 7
 Sis Boom Bah Performed at Jr. High Activity Period
 Hospital Board 6 p.m. at Hospital
- Nov. 8
 Deer Fest 6:30 p.m., Civic Center
 Just Say No Dance, Jr. High Cafeteria, 8-11 p.m.

- Nov. 9
 West Texas Singles Join San Angelo Group For Dancing At Cherry Springs 392-3891
- Nov. 10
 Candlelight Observance of Lord's Supper, First Baptist Church, 7 p.m.
- Nov. 11
 Commissioners Court 9 a.m.
- Nov. 12
 West Texas Singles 7 p.m., Chamber Office

Child Welfare Board needs toys for all age youngsters

Time is running out for you to help make a child's Christmas brighter this year. The Crockett County Child Welfare drive is underway to collect toys for underprivileged children of the community.

New or useable toys may be left at the fire station for wrapping and distribution. Donations of ribbon, wrapping paper and cash for purchase of these supplies or toys are welcomed.

Toys will be accepted through Dec. 20.

Tipsy Taxi to operate for New Year holiday

Members of a newly organized group to combat alcohol and drug abuse met Monday night and made plans to provide New Year's Eve transportation for persons under the influence.

Volunteers are needed to answer phones, pick up and drive people home between the hours of 10 p.m. and 4 a.m. If you have time to give to this project, contact Chesta Stuart at 392-3577 or Cathy English at 392-3878.

Notice to all Candidates!

SEC. 251.015 (A) of the Texas Election Code reads: It is unlawful for any person to knowingly enter into a contract or transaction to print or publish any political advertising which does not disclose thereon that it is political advertising and which does not state thereon the name and address of the person who personally entered into the contract with the printer or publisher.

THE OZONA STOCKMAN WILL REFUSE TO PUBLISH OR PRINT ANY POLITICAL ADVERTISEMENT THAT DOES NOT COMPLY IN EVERY RESPECT WITH THE ABOVE CODE.

POLITICAL ANNOUNCEMENT RATES AND RULES FOR THE OZONA STOCKMAN

State.....	\$55.00
District Offices.....	\$50.00
County Offices.....	\$45.00

NOTE: Candidates will be listed on a first-come, first-serve basis. The name will appear in this column as long as he/she is in contention; or, until they are unopposed for the office.

Payment entitles the candidate to ONE announcement write-up on the front page at any time they wish to have it published. Pictures may be included at no extra cost if furnished by the candidate. There will be no further front page write-ups on behalf of any candidate once the

first one is published.

Candidate's name and address, or the name and address of their campaign manager, must appear on all advertising, including political announcements. All announcements, advertising and printing work is cash in advance.

The Stockman will assist any candidate with composing advertisements, printing and/or announcements at no cost as long as the work is placed with The Ozona Stockman.

Political Announcements

SUBJECT TO THE ACTION OF THE DEMOCRATIC PRIMARY, TUESDAY, MARCH 13, 1990

For County Judge: Kathryn Mayfield, re-election

(Pol. adv. pd. by Kathryn Mayfield, P.O. Drawer 2096, Ozona, TX 76943)

For County Clerk: Debbie Puckett, re-election

(Pol. Adv. Pd. For By Debbi Puckett, Box 75, Ozona, TX 76943)

NEWS REEL DEC. 22, 1960

29 years ago
 Susan Brown, granddaughter of Mrs. J. M. Baggett and the late Mr. Baggett of Ozona, has been selected as a special goodwill ambassador by the U.S. State Department to attend the All-India Science Congress in New Delhi, India.

29 years ago
 The Ozona High School girls' basketball team ran its streak Monday night when they downed the Rankin girls 31 to 26 in Rankin.

29 years ago
 The Nelson Long home in west Ozona was judged winner of the Ozona Garden Club's Christmas lighting contest.

29 years ago
 Mrs. Maude Parker Young, 75, an early day resident of Ozona, daughter of Dave Parker, former sheriff of Crockett County, died recently at her home in Tucson, Arizona.

29 years ago
 The Ozona Lions rode the fine shooting of Van Miller and guard Phillip Carnes along with the powerful rebounding of Mike Stiles and Wayne Albers to a 59 to 36 win over the McCamey Badgers Tuesday night.

29 years ago
 The Ozona girls' basketball team won the consolation title at the Rock-springs tournament this weekend.

29 years ago
 Jake Young, Jr., Miss Barbara Ann Wiggs exchanged wedding vows in El Paso Saturday.

29 years ago
 Mrs. Joe Clayton was bridge

hostess at the meeting of the Ladies Golf Assn. at the country club last Thursday.

29 years ago
 Mr. and Mrs. Ernie Boyd have gone to Sulphur Springs to visit with parents of both Mr. and Mrs. Boyd who reside in Sulphur Springs.

29 years ago
 Mr. and Mrs. Sidney Moughon and children, Dan, Wes and Dinah, returned to their home Tuesday after spending the weekend here visiting Mrs. Moughon's parents, Mr. and Mrs. Evert White.

29 years ago
 Miss Linda Millsbaugh, daughter of Mrs. Sid Millsbaugh, Jr., of Ozona, is home from Christian College in Columbia Missouri, for the Christmas holidays.

Immunization Clinic set

The Texas Department of Health will hold an immunization clinic Thursday, Dec. 7, from 10 a.m. until noon and 1 to 3 p.m. at Ozona Civic Center.

Immunizations provided will be DTP, Td, polio, MMR and Hib. For more information, call 392-2996.

EMT registration continues

The Emergency Medical Technician class forming for early January now has 12 persons registered. Only eight more places are open, according to Doug Meador.

Anyone wishing to take the course should contact Meador to register.

DEC. 24, 1931

Delay in opening of the new high school building seemed apparent the first of this week when report was made to authorities that finishing work required on the building would not be completed in time for occupancy when classes are resumed on December 28.

Members of the Sunflower Bridge Club enjoyed their annual Christmas party in the ballroom of the Hotel Ozona Tuesday night.

Jane Augustine, small daughter of Mr. and Mrs. Walter Augustine, has been seriously ill the past week but is reported improved.

John Fogarty suffered a double fracture of his leg Friday when a horse fell with him on his ranch.

Members of the Ozona Music Club enjoyed a Christmas program and luncheon at the Methodist Church last Thursday. Mrs. W. J. Grimmer was program leader and Mrs. R. R. Dudley and Mrs. Vernon Cox, hostesses.

Ballinger hosts Christmas Past and Present Dec. 9

Christmas past and present will live in Ballinger Saturday, Dec. 9.

Visitors to downtown Ballinger will be able to step into the past between the hours of 2 p.m. and 7 p.m. Saturday.

Events scheduled during the day include strolling carolers, food and crafts booths, a live nativity scene on the courthouse lawn, a Christmas melodrama, quilt display, antique cars, live music, a Christmas cantata, a tour of historic homes and a celebration of lights tour.

All activities except the tour of homes and food and crafts booths will be free of charge.



Christmas Wonderland

Everything for your Holiday Feast

HOMETOWN PROUD

Prices good Wednesday, December 6 thru Tuesday, December 12, 1989
Limit rights reserved

Double Coupons
Every Tuesday

OPEN SUNDAY
12 noon to 6 p.m.



Round Steak

\$1.79
LB.

BONELESS
Beef Rump Roast
USDA "P.S." BEEF
1/4-INCH TRIM
\$1.99
LB.

MR. TURKEY
Turkey Ham
BONELESS • HALF
\$1.29
LB.

IGA
Meat Franks

12-OZ. PKG. **69¢**

IGA
Sliced Bacon

1-LB. PKG. **\$1.39**

GOV'T INSPECTED
Fryer Breast

FAMILY PACK FRESH FROZEN LB. **\$1.39**

IGA • ASSORTED
Lunch Meats

1-LB. PKG. **\$1.19**

MR. TURKEY
Ground Turkey

1-LB. PKG. **89¢**

USDA CHOICE • "P.S." BONELESS
Heel-O-Round Roast

LB. **\$1.89**

WILSON • ASSORTED
Smoked Sausage

LB. **\$2.19**

BONELESS BEEF
Sirloin Tip Steak

LB. **\$2.59**

T.V. • ASSORTED
Wafer Meats

2 1/2-OZ. PKG. **39¢**

IGA FULLY COOKED BONELESS
Whole Hams

LB. **\$1.98**

CENTER-CUT BONELESS
Round Steak

LB. **\$1.98**

COUNTRY SKILLET
Catfish Nuggets

LB. **\$1.89**

Dr. Pepper
ALL KINDS
\$1.58
6 PK. 12 OZ. CANS

IGA Macaroni and Cheese Dinners
\$1.51
7 1/4-OZ. BOXES

Rainbow Flour All Purpose
69¢
5-LB. BAG

IGA Bathroom Tissue
\$1.49
8-ROLL PKG.

RAINBOW • WHOLE KERNEL OR CREAM STYLE
Golden Corn

16-OZ. CAN **39¢**

IGA
Paper Towels

2 JUMBO ROLLS **\$1**

RAINBOW TOMATO OR CHICKEN NOODLE
Soups

3 10 1/2-OZ. CANS **\$1**

T.V. PETS CHOICE
Dog Food

20-LB. BAG **\$2.99**

IGA SALTINE
Crackers

2 1-LB. BOXES **\$1**

IGA
Liquid Bleach

GAL. JUG **79¢**

RAINBOW
Fruit Mix

16-OZ. CTN. **59¢**

T.V.
Potato Chips

7 1/2-OZ. PKG. **69¢**

RAINBOW
Aluminum Foil

2 25-SQ. FT. ROLL **\$1**

IGA
Salad Dressing

32-OZ. JAR **99¢**

T.V. • 60 SMALL, 48 MEDIUM, 32 LARGE
Ultra Diapers

YOUR CHOICE **\$6.99**

IGA BRAND
All Purpose Laundry Detergent

42-OZ. BOX **99¢**

T.V. • FLAVORED
Rice Mix

8-OZ. BOX **59¢**

RAINBOW ASSORTED
Cookies

16 OZ. PKG. **99¢**

RAINBOW TAGLESS
Tea Bags

BOX OF 100 **79¢**

T.V.
Corn Syrup

32-OZ. JAR **99¢**

RAINBOW 5 LB. LOG EA.
Fire Logs

\$1.29

IGA 32 OZ. BTL.
Chocolate Syrup

\$1.29

T.V. ASST. CUTS 15 OZ. CAN
Pinapple

59¢

GOLDEN STATE QT. BOTTLE
Motor Oil

59¢

CALIFORNIA
Navel Oranges
\$1.29
4-LB. BAG

FRESH
Broccoli

LB. **49¢**

WASHINGTON
D'Anjou Pears

LB. **39¢**

ICEBERG
Lettuce

2 HEADS **\$1**

FRESH
Vegetable Soup Mix

3-LB. PKG. **\$1.49**

FRESH
Juicy Limes

20 FOR **\$1**

WASHINGTON
Red Delicious Apples
89¢
3-LB. BAG

LOTS OF FLAVOR
Yellow Onions

5 LBS. **\$1**

EAST TEXAS
Sweet Potatoes

LB. **49¢**

TV
Vegetables
CORN, PEAS, OR MIXED VEGETABLES
89¢
20-OZ. BAG

IGA
Biscuits
HOMESTYLE OR BUTTERMILK
\$1.06
7 1/2-OZ. TUBES

T.V. • NON-DAIRY
Whipped Topping

8-OZ. CTN. **49¢**

T.V. - CHILLED
Orange Juice

64-OZ. CTN. **\$1.69**

T.V. • ASS'T.
Frozen Pizza

10-OZ. CTN. **69¢**

T.V. • 9-INCH
Pie Shells

PKG. OF 2 **69¢**

T.V. FRESH FROZEN
Tater Puffs

32-OZ. BAG **\$1.19**

T.V.
Cream Cheese

8-OZ. PKG. **79¢**

T.V. HALFMOON
Colby Cheese

16-OZ. PKG. **\$2.69**

T.V. HALFMOON
Mild Cheddar

16-OZ. PKG. **\$2.69**

T & T VILLAGE SUPERMARKET
916 11TH
VILLAGE SHOPPING CENTER
392-2251
STORE HOURS
MON. - SAT.
7:00 A.M. - 7 P.M.
SUNDAY, 12 NOON - 6 P.M.



The new Dairy Queen is expected to be completed in March as work continues this week to clear these lots on Avenue C. by I-10.

Construction of new Dairy Queen to begin

Work began this week to clear a site for construction of a Dairy Queen in Ozona.

Expected to be completed in early March, the business will seat more than 100 people, said Jane and Wade Richardson. Located on the I-10 north access road between Avenues C and D, the store will have the potential to draw travelers into Ozona, the Richardsons believe.

The grounds include parking space for 50 vehicles and a large playground area. A jungle gym, suspension bridge, three slides, merry-go-round, teeter totters and two picnic tables will fill the playground.

The large trees on the lots will not be removed, Richardson said.

A standard Dairy Queen menu of ice cream products, steak fingers, chicken strips, burgers, tacos, taco salads, fish and chicken sandwiches

will be offered.

At a separate counter, Blizzard lovers will be able to choose from a large selection of additions to the treat. A new product for the weight-conscious, a Breeze, will be similar to the Blizzard but made of frozen yogurt.

Fresh ground coffee will also be featured at the Ozona Dairy Queen.

The Richardsons anticipate hiring 20-30 employees, but no applications will be accepted until about Jan. 1. Key personnel will be trained for one week in a Dairy Queen and will also receive a week of local training before the opening of the shop.

Mrs. Richardson recently completed a two-week management training course at Minneapolis-based International Dairy Queen.

During the course, she and 28 other store operators from the U.S. and Canada received instruction on pro-

duct preparation, sanitation procedures, employee management and financial management.

With more than 5,100 Dairy Queen stores in all 50 states, Canada and 14 other countries, International Dairy Queen is one of the world's largest retailers of fast food and frozen dessert products.

Sheriff's Report

Week ending 12-05-89

ARRESTS

11-28-89...Leslie Dean Russell, age 27, from Florida, was arrested in San Antonio in possession of John Hoover's stolen Cadillac. Sheriff's deputies returned him to Ozona where he is charged with unauthorized use of a motor vehicle.

11-29-89...Lindell Floyd Copeland, age 37, of Alabama, was arrested on warrants charging him with theft by check. He was later released, after posting bond on the charge.

11-02-89...31-year-old Kirby Lynn Kirkland of Ozona was arrested by sheriff's deputies on charges of driving while intoxicated. He was later released after posting bond.

12-02-89...54-year-old James Lewis Crossland, of California, was arrested by sheriff's deputies on

charges of public intoxication. He is still in county jail laying out his fine.

12-03-89...Christopher Jude Jordan, age 19, of California, was arrested by sheriff's deputies while in possession of a car reported stolen from California. Jordan was released on 12-04-89 after California refused to extradite.

12-04-89...43-year-old Elisa Trujillo of Ozona was arrested by sheriff's deputies on a warrant charging her with probation revocation. She was later released after posting bond.

INCIDENTS

12-03-89...Sheriff's deputies are

investigating a report of an 18-year old-Ozona man accused of threatening a 23-year-old Ozona man. Formal charges have not yet been filed.

12-04-89...Art Roane, of Double T Ranch, reported the theft of a tool box from his truck while he was parked at Thornton's Supermarket.

Notice of REWARD
I AM OFFERING
\$500 REWARD
for apprehension and conviction of guilty parties to every theft of livestock in Crockett County - except that no officer of Crockett County may claim the reward.
Jim Wilson
Sheriff, Crockett Co.

WESTERN ART SHOW & SALE

FRIDAY, DECEMBER 8, 1989

Main Lobby - ONB
10-12 a.m. & 1-2 p.m.



RAUL RUIZ

Sheepshearing Artist from San Angelo
The Finest in Angoras and Rambouillets

House Fuel Company Local FINA Distributor

- ★ Kerosene
- ★ Methanol
- ★ Gasoline & Diesel
- ★ Motor Oil

103 Avenue E.
Phone 397 3010

SCHOOL LUNCH MENU

Cafeteria	Fast Food
Monday, Dec. 11...Spaghetti w/Sauce, Vegetable Salad, Buttered Green Beans, Cornbread, Pudding and Milk	Monday, Dec. 11...Hoagie Sandwich, Lettuce & Tomatoes, Tator Tots, Pudding and Milk
Tuesday, Dec. 12...Tacos Lettuce & Tomatoes, Ranch Style Beans, Cake and Milk	Tuesday, Dec. 12...Taco Salad, Lettuce & Tomatoes, Ranch Style Beans, Cake and Milk
Wednesday, Dec. 13...Pizza, Nachos, Tossed Salad, Buttered Corn, Fruit and Milk	Wednesday, Dec. 13...Soft Burrito, Nachos, Tossed Salad, Buttered Corn Fruit and Milk
Thursday, Dec. 14...Hamburger, Salad, French Fries, Fruit and Milk	Thursday, Dec. 14...No Fast Food
Friday, Dec. 15...Turkey & Dressing w/ English Peas, Gravy, Fruit Salad, Cranberry Sauce, Hot Rolls and Milk	Friday, Dec. 15...No Fast Food

BREAKFAST MENU ALL SCHOOLS
Choice of: Muffins and Toast, Served with Juice and Milk

Take advantage of our GOING OUT OF BUSINESS SALE

Our customers have been asking, "Any further reductions"?

So to make the gift buying even more attractive, we have made added discounts

20% to 30% off

of many sale prices - which means you can find many special gifts up to

70% off

Baker Jewelers

1008 Ave. E.
Ozona, Texas 76943

DIAMOND
• Rings
• Pendants
• Bracelets
• Earrings

Cultured Pearls
• Necklaces
• Bracelets
• Earrings

Cross Pen & Pencils

Ladies' & Men's Watches
30% to 70% off

Gold & Silver Charms
MAKE SPECIAL GIFTS WHEN ENGRAVED

EXTRA SPECIAL French Cathedral Crystal
by Gorham 36 pc. set
REG. - \$1,215.00
THIS WEEK ONLY
SALE \$444.00

Wedding Bands
Plated Holloware
Belleek Vases & Pitchers

Picture Frames

Stainless Steel Flatware
Pottery & China
Cut Crystal

BRASS SELECTIONS
• Trays • Vases
• Bowls • Pitchers
• Candlesticks

Snips, Quips, & Lifts

By Lottie Lee Baker

The worst danger that confronts the younger generation is the example set by the older generation.

Great riches await the man who will manufacture crutches for lame excuses.

Walking a mile for a cigarette may be healthier than smoking one.

Too many people confine their exercise to jumping to conclusions, running up bills, stretching the truth, bending over backwards, lying down on the job, sidestepping responsibility and pushing their luck.

Education is what you get from reading the fine print in a contract. Experience is what you get from not reading it.

By the time you learn all the lessons of life, you're too old and weak to walk to the head of the class.

Be careful about calling yourself an expert. An EX is a has-been, and a SPURT is a drip under pressure.

Planned economy is fast becoming a calculated extravagance.

Too many of us spend our time like our politicians spend our money.

There is nothing as effective as a bunch of facts to spoil a good rumor.

Failures are divided into those who thought and never did, and those who did and never thought.

Too much of the Christian faith has become trimming on the dress of life instead of a part of the fabric.

It's a happy home where the only scraps are those brushed off the dining table.

Fanaticism is the false fire of an overheated mind.

If Congress can pay farmers not to raise crops, why can't we pay Congress not to raise taxes?

Every part of the family constitutes a part of the family tree. Father is the rough bark and fiber, the rugged part which supports and protects it. Mother is the heart, which must be sound and true or the tree will die. The daughter may be likened to the leaves and flowers that adorn it. The son is almost always the sap.

A LIFT FOR THE WEEK
Faith either moves mountains or tunnels through.

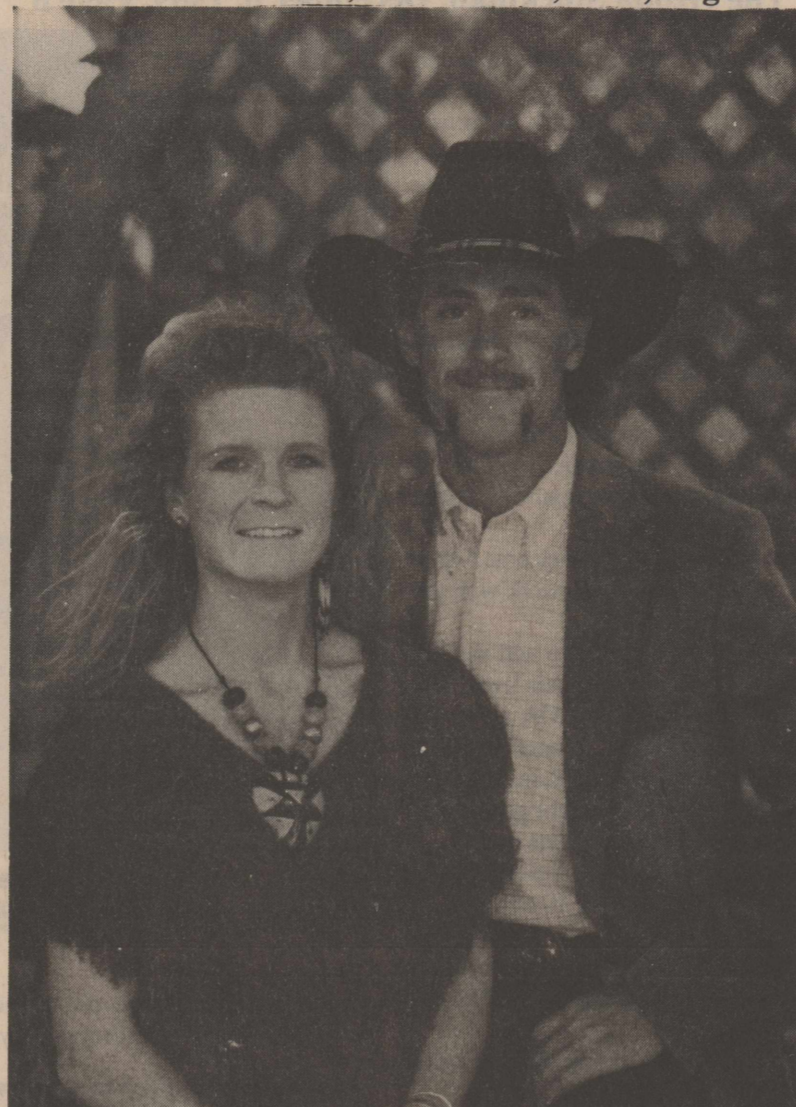

Watts-Baker wedding plans told

Candy Lee Watts will become the bride of R. J. "Bubba" Everett III of Ozona during a ceremony Dec. 30 in the home of her parents.

Mr. and Mrs. Jim Watts of Iraan are the parents of the bride-elect. The prospective bridegroom is the son of Mr. and Mrs. R. J. Everett Jr. of Ozona. She is the granddaughter of Jeff and Laura Owens of Ozona. Everett's grandmothers are Mrs. R. J. Everett of Fort Stockton and Mrs. R. L. Baker of San Angelo.

Miss Watts is a 1983 graduate of Iraan High School and a 1987 gradu-

ate of Panhandle State University in Goodwell, Oklahoma. Bubba is a 1980 graduate of Ozona High School and attended Southwest Texas Junior College in Uvalde.

Contest underway to name new organization

A local group of concerned citizens is looking for a name for their organization. The group is a result of the communitywide meeting sponsored by the County Extension Office.

These citizens are concerned with making the community more aware of the problems of substance abuse and providing alternatives.

The organization will have access to counselors who will be available to

the community.

Name the organization entries must be submitted to The Ozona Stockman office by 4 p.m. Dec. 15.

A \$50 cash prize will be awarded to the winner by the organization at its meeting on Dec. 18.

The group meets on the first and third Mondays of each month at 6 p.m. in the high school cafeteria. All interested persons are invited to attend.

FOR SALE

Best Buy of the Week

INTERSPRING MATTRESS & FOUNDATION

TWIN SIZE	\$125	QUEEN SIZE	\$200
FULL SIZE	\$150	KING SIZE	\$250

TERMS AVAILABLE FOR QUALIFIED BUYERS

Buy any twin size set - **GET ONE PILLOW FREE**

Buy any full size set
GET ONE PAIR PILLOWS FREE

Buy any queen size set
GET A PAIR OF QUEEN SIZE PILLOWS FREE

Buy any king size set
GET ONE PAIR KING SIZE PILLOWS FREE

Brown Furniture Co.

906 Ave. E. Ozona, TX 392-2341

Eastern Star Chapter honors Deputy Grand Matron

Eastern Star Chapter Number 287 of Ozona honored the Deputy Grand Matron Marjorie Russel of Menard with a salad supper, Tuesday, in the Crockett Room.

Hostesses and guests met and enjoyed a fraternal visit during the meal, then met in the lodge hall for a stated meeting.

Visitors and guests from Big Lake and Sonora participated in presenting the deputy grand matron and grand committee members. Those introduced were Kaleta Shepperson, Polly Mayes, Charlotte Wilson, and Dorothy

Pettit, grand committee.

The deputy grand matron spent time training members in their work.

Miss Russel reminded the members that any woman who is eligible may petition for membership. The order is dedicated to friendship, love, and compassion for each other and others in trouble who need aid.

Polly Mayes and Leonard Hillman, Worthy Matron and Worthy Patron, presided over the meeting. Regular stated meetings of this organization are held on the fourth Tuesday of the month.

Country Club Bridge news

Winners at Country Club Bridge on Nov. 30 were: Mrs. Joe Couch, high; Mrs. Charlie Black, second high; Mrs. Arthur Kyle, Mrs. Bill Mason and Mrs. Florence Taylor, bingo.

Other players included: Mmes. Joe Bean, George Bunger, John Childress, W. E. Friend, Jess Marley, Beecher Montgomery, Rip Sewell, C. O. Walker, Evert White, Charles Williams, Byron Williams, Gene Williams, Jack Williams, Roger Dudley and the hostess, Mrs. Clay Adams.

It's a boy!

Charles and Chatter McDonald of Bangs are the proud grandparents of a grandson, Charles Eugene McDonald, III, born Nov. 28, 1989, at 5:47 a.m. in Springfield, Missouri to Charles and Karen McDonald. The baby weighed seven pounds. Other local relatives include an uncle, Monroe McDonald also of Bangs.

Happy Birthday

Dec. 6 - Candace Ganda
Dec. 8 - Amanda Ramirez, Jimmy Tambunga
Dec. 9 Samuel Fuentes, Terry Adams, Copie Davis
Dec. 10 - Margaret Spiller
Dec. 13 - Roy Moore, Billy Reagor, Cookie Worthington, Pie Pierce, Jack Baggett Jr.

Electric Sewerooter
Clears CLOGGED PIPES,
DRAINS, SEWERS
No Digging - No Damage

Raul De La Rosa
Plumbing Service
& Ditch Digging
Call 392-2726

Happy anniversaries to Mr. and Mrs. Sam Houston who will observe their 57th anniversary on Dec. 12.

Visiting the Rick Bachman family this week is Debbie's sister, Barb James of Milwaukee, Wisconsin.

For all your Mary Kay products please contact:

Mary Kay Annette Badillo
392-2910
or Annadelia Fierro
392-3604
please call after 6:00 p.m.

OPEN EVERY THURSDAY NIGHT TILL CHRISTMAS

DRAWING EVERY THURSDAY

Ozona Mercantile

WE WILL BE OPEN AT 1 P.M. SUN., DEC. 24, 1989

1014 AVE. E.
392-2415

Ozona, TX December 6, 1989

COTTON EYED JOE

24 Of The Best Instrumental Texas Fiddle Songs

Waltz Across Texas	Under the Double Eagle
Faded Love	Put Your Little Foot
Amazing Grace	Westphalia Waltz
Goodnight Waltz	Time Changes Everything
Wild Wood Flower	Jalisco
San Antonio Rose	Your Cheatin' Heart
Stay All Night	There Goes My Everything
Greenville Waltz	Blue Eyes Crying In The Rain
Maidens Prayer	Last Letter
South	I'm So Lonesome I Could Cry
Redwing	Wednesday Night Waltz

And of course Cotton Eyed Joe

24 Hits on two cassettes for only \$12.00. Tax, postage and handling are included.

Make personal check or money order payable to:

ROY SALES COMPANY
P.O. Box 1503
Brownwood, Texas 76801
Send This Add In With Order

THE HITCHIN POST STEAKHOUSE

Located at the Ozona Inn of the West **OPEN: 4:30 a.m. - 10 p.m.**

FRIDAY - ALL DAY FISH FRY

ALL YOU CAN EAT

\$5.50 Adults \$2.00 Kids

THURSDAY

Best Steakfingers in Crockett County

Handbreaded & Deep Fried

ALL YOU CAN EAT

\$5.50 Adults \$2.00 Kids

Village Drug

VILLAGE SHOPPING CENTER

HOLIDAY HOURS

Monday, 12/18 thru Friday, 12/22 - 8 a.m. - 7 p.m.
Saturday, 12/16 & 12/23 - 8 a.m. - 6 p.m.
Open Christmas Eve - Sun., 12/24 - 12 - 6 p.m.

*** Shop here for all your holiday gifts ***

- Millionaire® candies, regular and dietetic
- Christmas wrapping paper and bows
- Christmas cards
- One of a kind Christmas ornaments
- 25% off electrical appliances
- Cameras, tape player, cassettes
- Christmas cassettes (Your favorite artists)
- Best selection of colognes in Ozona
- Jewelry and other gift ideas

"COME AND SEE OUR SELECTION"



Oscar Gutierrez prepares to do deadlifts assisted by Duane Armijo, trainer/owner of The Body Shop. Watching his technique are Edward Chipman and Marsha Cannon, co-owner of the new enterprise.

Flat and incline benches, a lateral pulldown machine, two dumbbell benches, power squat rack, calf-raise, leg curl and leg extension machines, three way power sled, two complete Marcy gyms, two exercycles and 3,000 pounds of free weights offer opportunities to build up or tone up as the customer desires.

Additional equipment will be added based on customer response.

Membership includes use of the equipment and participation in aerobics classes. A partition will be installed to separate the gym equipment and aerobics area.

"Suggestions are welcome," said Cannon. "We want to work with the entire community."

For those wishing to add supplemental vitamins to their lives, The Body Shop carries AMA approved Neo-Life vitamins, minerals, protein drinks and Kwik Meal Bars. Neo-Life includes diet and weight gain plans, stress vitamins and sports packs.

Currently open from 6-8 a.m. and 4-10 p.m. weekdays, 10 a.m.-8 p.m. Saturday and 1-6 p.m. Sunday, the owners of The Body Shop are willing to gear business hours to public response.

"We plan to be here. Fitness is not a fad," Armijo said.

Fitness no fad at Body Shop

Developing a healthier body through exercise and body building may be separate goals for patrons of The Body Shop. Working out to achieve fitness doesn't necessarily mean body building according to owners Marsha Cannon and Duane Armijo.

Armijo, a three-year veteran of body building, and Cannon are trainers at The Body Shop, and Alicia Gonzales instructs aerobics classes.

The workout center offers Parabody equipment, the aerobics classes, and vitamin therapy for those seeking a healthier life.

"After six weeks I guarantee you will feel and look better," said Armijo. New members at The Body Shop work out three times a week the first two weeks with a focus on the total body. The remainder of the month is spent becoming familiar with equipment and basic weight lifting movements and exercises.

Membership at The Body Shop includes one month of training, then patrons are assisted in setting up their own routine and schedule tailored to individual needs.

Membership rates are \$15 per month for high school students, \$20 per month for non-student singles and \$30 per month for couples. Parental permission is required for high school students under 17.

After the first month, specialized training is available at an additional charge.

A program compatible with the school's has received good response from students according to Armijo who sees increased self-confidence and self-motivation as added benefits.

Safety and supervision are important at The Body Shop. A trainer will be at the shop at all times, said Armijo.

Christmas issue planned for December 20

The Christmas issue of The Ozona Stockman will be published Dec. 20. To reserve your Christmas greeting ad, come by The Stockman or call 392-2551.

Deadline for the Dec. 27 and Jan. 3 issues will be 5 p.m. on Friday before publication.

Happy birthday to Amanda Rae Ramirez who will be 5 on Dec. 8.

Card of Thanks

I want to thank everyone for all their kindness during my Mother's illness and recent stay. Special thanks go to Dr. Sims and the hospital staff.

Your many thoughtful gestures, the cards, letters and well-wishes remind me once again of the blessing of having and being a friend.

Ozona is the best place in the world to call home.

Patsy Cain and Family



Doc O' Dan bred and raised by Lorelei McMullan of Ozona made the finals in the Reining competition and won ninth in Oklahoma City, Oklahoma at the World Show.

Bonnie Warth is home to continue her recuperation from recent surgery.

Mrs. Laura Leach of Kessingland, England is here for a visit with her daughter and son-in-law, Dee and John Jordan.

Happy birthday to Pete Ramirez who celebrates on Dec. 6.

Overstocked

More vehicles coming in EVERYDAY!
Must Sell to make room for incoming vehicles

Reduced Prices & Rebates

We will meet or beat any deal from any other FORD dealer in the state!

Sonora  **FORD** Sales
387-2549 115 NW Concho Call: Leslie Gray

NAPA AUTO PARTS

HOLIDAY

Hurry In for Big Savings!

At participating stores only. Sale ends December 24, 1989.

gift sale

BLACK & DECKER® 1/4" Cordless Ratchet

120 RPM. Reversible. Long lasting charge. Wall mount charger. Manual setting for extra torque. Includes 7 screwdriver bits. #6080 Reg. price \$78.00

39.99 PLUS FREE CAR VAC

With ratchet purchase get mail-in coupon at counter for FREE BLACK & DECKER® Car Vac #9509



NAPA Battery Charger

6/2 Amp—6 & 12 Volt Self-resetting circuit breaker #85163 Reg. price \$39.59

29.95

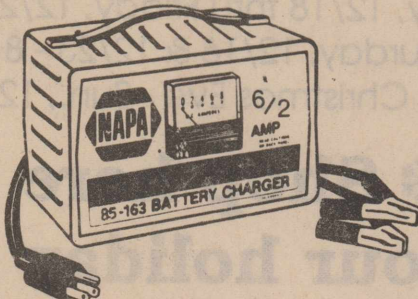

NAPA Legend Battery

75 Month Battery #7524, 7524F, 7574

59.95 EXCH



NAPA Halogen Headlights

See farther. Drive safer. Light years ahead of ordinary headlights. As low as \$6.74 ea. #H6054, H6024, H4651, H4656 H5001, H5006, 9004

25% OFF

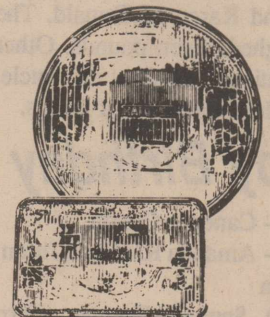

Save up to 60% on popular NFL™ Merchandise!

Order forms at store. \$10 minimum purchase required for NFL merchandise discounts.



Order your NFL hats, t-shirts, sweatshirts, jackets and much more in your favorite team's logos and colors, at savings up to 60%! Example: Hat w/ embroidered logo just \$4.95!



BLACK & DECKER® Bullet Drill Bit Sets

For metal and wood. Drills faster. Lasts longer. Pilot Point™ tip eliminates walking.

4 PC. Reg. price #14345 \$12.32

6.99



NAPA EZ-Tote Tool Organizer

8 self-locking drawers for small items. Carrying handle. #827-1159 Reg. price \$16.95

13.99

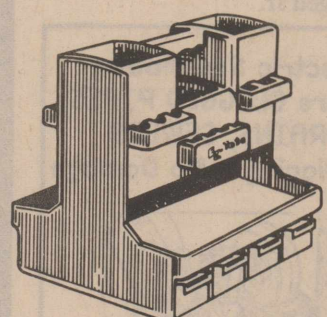

Do you have a NAPA/VISA card yet?
NAPA VISA MEXICO MEXCART At most stores.

CALL 1-800-LET-NAPA FOR THE NAPA AUTO PARTS STORE NEAREST YOU.



Crockett County Care Center News

by JoAnne Marshall

Residents were busy making Mr. and Mrs. Santa Claus wreaths in Monday morning's craft class. Attending the class were Virginia Hoover, Consuelo Sarabia, Frances Davis, Juana Hernandez and Moriana Perez.

Residents tested their hand and eye coordination Monday afternoon in a game of basketball. Juana Hernandez remained the high scorer. Consuelo Sarabia came in second. Participants were: Olive Berry, Monnie Boyd, Lucia Rios, Nellie Harp, Moriama Perez and Santos Martinez.

Volunteers for Tuesday morning's bingo were Toshia Nowell and Georgia Kirby. Prize winners were Frances Davis, Alice Ross, Adelaida Smith, Srida Senne, Lucia Rios, Hazel McDaniel, Santos Martinez, Bertha Miller and Virginia Hoover. We would like to thank Toshia and Georgia for lending us a helping hand.

Tuesday afternoon residents played dominos. Well-matched residents were: Theo Burns, Floy Clare Short, Myrtle Post, Srida Senne and Hazel McDaniel.

Volunteers Ruth Hester, Ruthie Doris and Alma Bednar kept things moving smoothly in Wednesday morning's ceramic workshop. Thank you, ladies. We appreciate your hard work. Residents attending the class were Juana Hernandez, Consuelo Sarabia, Hazel McDaniel, Theo Burns, Srida Senne, Chata Tambunga, Frances Davis and Moriana Perez.

Relaxing in front of the television or playing dominos seemed to take

care of Wednesday afternoon's activities.

Thursday morning's activities started with a trip to the center's beauty shop and a visit with volunteers Vivian Hughes, Joann Williamson, Lola Rios and the OHS cosmetology students. After getting lovely hair styles, the residents enjoyed a delicious lunch. Later that afternoon residents listened to a short Bible lesson presented by Charles Huffman of Faith Lutheran Church. Hymns were sung and Ruby Olson played the piano. We would like to thank the members of the Lutheran Church for sharing their time with us.

Thursday's activities ended with the Spanish Hour of Praise. Hymns were sung, and Alicia Perez played the guitar. Communion was offered. We would like to thank the large number of visitors from Our Lady of Perpetual Help Catholic Church for attending this activity with us.

Friday morning's bingo winners were Juana Hernandez, Frances Davis, Adelaida Smith, Srida Senne, Lucia Rios, Hazel McDaniel, Elvira Pena, Virginia Hoover and Carmen Mendez. We would like to thank Doris Karr for her assistance. We appreciate her time.

Sunday's worship service was presented by Ozona United Methodist Church. Communion was offered, and Ken Harrison gave a short sermon. Residents were delighted with the singing, especially the one done by Ken and his family. We would like to thank the members of the Methodist Church for uplifting our spirits.

Woman's Missionary Union studies missions in Japan

Woman's Missionary Union of First Baptist Church met in the church parlor on Wednesday for a study of foreign missions in Japan.

Geneice Childress, Mission Study Chairman, led the study dealing with missionaries and problems facing those who spend time winning converts in the extremely urbanized cities of Japan.

Mrs. Childress spoke of the affluence of the citizens in this busy country as people rush about on their way to jobs. It is well known that Japan has many factories where electronic products are made and sent to the states.

The people are well educated and trained to work. To the tourist they seem to be prosperous in the cities. The main problem for the missionaries is the worship of many gods and idols. Some devout people even have more than one religion, and practise both at once!

Mrs. Childress will present this interesting study on Sunday night and at other meetings. Polly Mayes sends a welcome to any interested women to meet with the group on the first and third Tuesday in the church parlor at 10:30 for business. Afterward the ladies of the church who have a job which prevents them from attending regular meetings are invited to meet at the Hitching Post at noon for a Dutch luncheon.

Saturday, Dec. 16, at 7:00 p.m., the Baptist women have invited all the ladies of the church to a supper in the church parlor to welcome the Grady Tennysons, a well loved former pastor. Husbands are also invited.



Lupe Gonzales (left) and George Ybarra, Texas Highway Department employees take a trial measurement in preparation for marking parking places on Avenue E.

Helping Hands Menu

Dec. 11 - Meat Loaf, Mashed Potatoes, Green Peas, Pickled Beets, Hot Rolls, Chocolate Cake

Dec. 12 - Baked Chicken, Spanish Rice, Buttered Corn, Hot Rolls, Pink Salad

Dec. 13 - German Sausage, Pinto Beans, Potato Salad, Cornbread, Peach Cobbler

Dec. 14 - Swiss Steak, Green Beans, Tasty Taters, Carrot and Raisin Salad, Pineapple Cake, Hot Rolls

Dec. 15 - Beef Stew, Cole Slaw, Cornbread, Sugar Cookies

Belated birthday wishes to Robert Flores whose special day was Nov. 30.

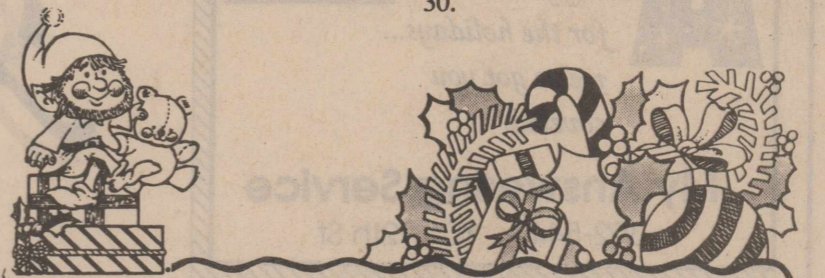

Special rack of
Christmas clothes
and
sleepwear

25% off

SMALL
FASHIONS

392-3266
1004
Ave E.

Iraan church to host evangelist

Pastors Jesus and Molly Galindo Jr. and the family of God at Faith Fellowship of Iraan are pleased to announce that Evangelist Don Evans of Lighthouse Ministries of Hillsdale, WI will hold special services Dec. 10-12. Times of the meetings will be twice on Sunday during regular worship, morning and evening, 10 a.m. and 7 p.m., and Monday and Tuesday evenings at 7 p.m. Faith Fellowship Church is located at 416 West 7th.

Brother Don and his wife, Joyce, have been in the Lord's ministry for

20 years. He stood in the office of pastor for 15 years and has traveled all over the world as an evangelist. Besides having had a radio ministry for 17 years, they publish a newsletter called It's Raining Miracles. Don is a man anointed of God to preach the Gospel and holds miracle and healing crusades, faith seminars and revivals.

Everyone is welcome and encouraged to come be blessed during these services. For more information, contact Jesus at Faith Fellowship Church in Iraan at 639-2734.

Yearbooks on sale

By Sarah Pullen

Ozona High School yearbook staff members have their plans underway for the 1989-90 yearbook. Sales for the upcoming book are also beginning.

A book may be purchased for \$20 from now until Christmas; however, after Christmas, the price will go up to \$23. Plastic protective covers can be purchased for an additional dollar.

Yearbooks may be purchased at the Ozona High School, junior high, intermediate or primary school offices or through several of the staff members. Annual staff members to contact to purchase a book are: Katie Sellers, Amy Graham, Martin Llanas, Christy Cotton, Sarah Pullen or Julie Childress. Sponsor for this yearbook is Mrs. Margaret Spiller.

Awards presented at Cub meeting

Members of Cub Scout Pack 153 held their pack meeting Thursday, Nov. 30, at the civic center.

The flag ceremony was led by the Webelos.

Boys earning Bobcat badges, the first badge in the Cub Scout Trail, were: Mario Barrera, Randall Borrego, Cade Clark, Ross Crawford, Tripp Farris, David Hernandez, Ernie Hernandez, Robert Huffman, Timothy Maldonado, Ty Mitchell, Jimmy Nowell, Robert Quiroz, Clay Richardson, Peter Rodriguez, Paul Sanchez, John Austin Stokes, Kenny Vargas, Travis Vordick, Seth Webster and Mason Wilkins.

Bears earning beads were: Albert Quintanar, Eric Garza, Ryan Ramos and Anthony Ortiz.

Webelos earning awards were: Byron Beasley, Robert Nelson, Mickey Munoz, Eliz Hernandez and David Martinez.

Cub leaders present for the meeting were Elizabeth Clark and Vicki Stokes. Elliott Barrera, Webelos leader, was also present.

Refreshments were served after a skit was presented by Webelos.

Bargains of the Month

True Value
HARDWARE STORES
BARGAIN OF THE MONTH

True Value
HARDWARE STORES
HARDWARE VALUE OF THE MONTH

True Value
HARDWARE STORES
True Value OF THE MONTH

Harcoard
Lifetime Warranty
9.99 While Supplies Last
2-Pc. Cutlery Set. 3-in. and 6-in. knives with high-carbon, stain-free steel blades. **QUANTITIES LIMITED**

SL WABER
7.66 While Supplies Last
7-Outlet Power Strip w/3-line surge and noise suppression. 15-amp circuit breaker. EPT5 **QUANTITIES LIMITED**

Master Mechanic
9.99 While Supplies Last
Master Mechanic[®] Electric Stapler is medium-duty. Drives 3 SIZES. TRE-300M **QUANTITIES LIMITED**

South Texas Lumber Co.

392-2634

1308 Ave. E.

The Spirit Of The Season

BY REV. RAYFORD HARRIS
FIRST BAPTIST CHURCH

Into each heart and life comes valleys and mountain peaks. The view from the lofty peaks of success and joy are stimulating and cause for optimism and hope. Life would never know this experience if it were all peaks and no valleys. These peaks give rise to plans and programs that push forward our land into accomplishments that bring good for all of us.

It was during the time spent in the valley that the greatest event of world history came about. Servitude and despair crowded out hope and joy. People were listless and with great effort did what was demanded of them. It was such demand that brought one couple to Bethlehem that season. They

came aware of the demand and tired and weary they sought rest in a manger. An event took place that night that changed despair to hope and gloom to joy.

A Saviour was born, a season was made one of joy and good will. Attitudes were changed to helpfulness

and sharing. Gladness brought smiles and good wishes while changed lives brought hope and victory to a desperate and defeated folk. This new attitude is what makes this such a wonderful season. In Christ, there is hope. In Christ, there is gladness and helpfulness. In Christ, there is life and security with the promise of comfort and care.

THIS IS TRULY THE SPIRIT OF THE SEASON.

Ozona Church of Christ Ralph Moore	Ozona United Methodist Church Rev. Ken Harrison		
Mt. Zion Baptist Church Rev. Norvell Allen	Faith Lutheran Church Charles Huffman, Pastor	Templo Siloe Assembly of God Church Bi-lingual Rev. Joe A. Menchaca	First Baptist Church Rayford Harris
Templo Bautista Rev. Carlos Venegas	Church of God of Prophecy Rev. Connie Marroquin	Our Lady of Perpetual Help Catholic Church Rev. Bill DuBuisson	Word of Life "Palabra de Vida" (Non-denominational)

This series of ads is being published and sponsored by these Ozona business firms in the interest of a stronger community.

Westerman Drug

Brown Furniture Co.

House Fuel

South Texas Lumber. Co.

Preddy Funeral Home

Ozona National Bank

Bernard Rust, DDS

Ozona Butane Co.

T & T Village Supermarket

Crockett County National Bank

Catch the Christmas Spirit in Ozona from



A to Z

Away from home for the holidays... we've got you covered.

My Answering Service
392-5440 801 12th St

Bent fender blues got you down? Let us fix you up.

Hubbard Body Shop
392-2008 907 Sheff. Rd

Chevron & Gulf credit cards accepted at

Kwik Mark
392-5440 404 Ave. J.

Deck your halls with an arrangement from

The Foot Note
392-5227
1003 1st St.

Enjoy a drink with your meal while watching wide-screen TV.

Horses Inn
Ozona Inn of the West

For all your auto repair and muffler needs...

B & C Automotive
392-2016 403 1st

Greetings from your boot, shoe and saddle repair headquarters

Davis Boot & Saddlery
392-5104 Ave. H.

Home owned associate store

Western Auto
392-2533
1104 Ave. E.

Imagine yourself in a Wild & Wooly fashion.

Wild N Wooly designs
Shawn Mitchell 392-3845

Jet on over to ninth street for newest in Ozona dining.

The Pizza Place
392-5851 On the Square

Keep your holiday fashions at their best with quality dry cleaning.

Kyle Cleaners
392-2339 706 8th

Let George do it, shell your pecans, that is

George Hester
392-2051
205 Ave. J.

Make your holiday decorating unforgettable.

Ozona Floral
392-2648 802 11th

Now is the time for a new hairstyle...

Cynthia's Beauty Shop
392-3421 Ave. H.

On the road? Let us be your home away from home.

Ozona Inn of the West
392-2663 Ave. A.

Portraits capture the holiday moment

Cameras Two
404 Ave. J.

Quality Carquest auto parts

J.W. Motor Parts
392-3734 516 9th

Run on over for all your NAPA automotive needs.

Crockett Automotive
392-3159 1202 Ave. E

Step out in style this holiday in a Dandy Duds creation

Dandy Duds
392-3325 203 Ave. J.

Time for a new hairstyle? Marge is ready to help you face the holidays with flair.

Marge's Beauty Cottage
392-3333 1002 9th

U can get 100% beef burgers at I-10 Hamburger Hut.

I-10 Hamburger Hut
392-3387 1309 Ave. C

Village Drug for all your prescription and gift giving needs.

Village Drug
392-2666 902 11th

We have all brands cold beer for your holiday parties.

B.J.'s
392-5844 157 Martinez

Xceptional gifts at

Happy Hollow
392-3403
1010 Ave. E.

You won't want to miss this special...hamburger with small drink \$2.25

Dee's Place
606 Martinez 392-3294

Zip into Elma's for all of your grocery needs this holiday.

Elma's Grocery
392-3479 Hwy 163 S.

Seventh grade Cubs and Cubettes win their own tournament

CUBS

by J. L. Tucker
STOCKMAN SPORTS

The seventh grade Cubs roared over Iraan and McCamey and then came from behind to defeat the Eldorado Eagles, before a packed crowd in Davidson Gym last Saturday night, claiming the championship trophy.

J. J. Lozano scored 14 points while Joe Esparza and Tony Valencia added ten and eight points respectively as the Cubs dominated the Iraan Braves in the opening game of the tournament. The Ozona team led 18-6 at the end of the first half and coasted to a "warm-up" with 43-14.

The Cubs returned to action Saturday morning and faced a tougher challenge in the McCamey Badgers. Leading 7-4 at the end of the first quarter, the young Lions' offense rolled to a 29-13 victory. Lozano and Chris Sanchez combined to score 12 points while Valencia, Doug Meador, and Jesse Garza added four points each.

In the meantime, Eldorado edged Reagan County 20-16 in first round action before dominating Ozona's "B" squad 40-15, therefore setting up the championship final Saturday night.

The Eagles threw up a full court zone press and a tough 1-3-1 zone which kept the Cub offense off balance the first half. Three unanswered Eldorado field goals broke open a tight ball game and gave the Eagles a 16-12 halftime advantage.

Ozona Coach Keith Shoush must have made some half time adjustments, as the Cubs roared to a 24-20 third quarter lead. But the suspense would heighten throughout the final six minutes as both teams failed to make their free throws and committed several costly turnovers. Lozano and Garza made a field goal each and the Cubs held off an Eagle rally to take the 1st place trophy with a 28-26 victory.

McCamey took third place in the tournament by defeating Ozona's "B"

team 29-17. The Ozona "B" squad won their opening round on Thursday against McCamey's "B" team 35-26. Andres De La Garza connected on 8 of 11 free throws and added 4 field goals for 16 points and played solid defense in leading the Ozona Cubs to victory.

The Reagan County Owls, losers to Eldorado in the first round of play, defeated Sonora 41-31 for the consolation trophy.

CUBETTES

The 7th grade Cubettes battled the Eldorado Eagles in a great basketball championship game and the Ozona squad came away with the first place trophy, last Saturday night in Davidson Gym before a large and vociferous crowd.

Gloria Pena-Alfaro hit 6 of 10 field goal attempts, pulled down 10 rebounds and added eight steals to her effort in leading the Cubettes to a chilling 24 to 20 win over the Lady Eagles. J. L. Tucker added seven points and two steals to the team victory.

The Cubettes opened the tournament with a 19-4 win over Iraan Friday afternoon. Pena-Alfaro scored 8 points, Tucker added 6 and Leigh Chandler led the team in steals and scored three points. "The girls played an excellent defensive game," commented Coach Brenda Pool.

Bright and early Saturday morning the Ozona young ladies faced the McCamey Badgers, a team who had defeated the Cubettes in their first meeting. After a hard fought first quarter with the Badgers leading 4-3, Ozona's defense stiffened and their offense began rolling to a 17-8 win. "The girls hustled their hearts out," said a proud Coach Pool.

Pena-Alfaro scored six points and hauled in five rebounds while Tucker and Connie Fielder added four points each. Chandler grabbed down six missed shots and Tucker collected five.

The championship game was a



Juan Trujillo fires off a jump shot while (52) Travis Davidson starts to move in for the rebound
Photo by Neal Ulmer

Freshmen Lions record two wins

by J. L. Tucker
STOCKMAN SPORTS

Manny Munoz poured in 27 points as the Freshmen Lions jumped to early first quarter leads against Eldorado and Sonora and went on to record two wins to start their basketball season.

The young Lions defeated the Eagles 44-22 at Eldorado before returning home to win against Sonora 41-31. The freshmen boys played in Iraan last Monday evening.

Joe Mendoza scored seven points against the Eagles while Joe Hernandez added six and led the Lions in

rebounding. Andy Borrego scored five points and played solid defense.

Munoz scored 12 of his points against Sonora, while Mendoza and Alonzo Hernandez each contributed eight. Munoz and J. Hernandez led the team in rebounds as Ozona pulled out to a 32-20 lead at the end of the third quarter.

"We are young and learning" said Coach Jerry Tucker, "but I was real pleased with their hustle and team work."

The freshmen Lions will host the Reagan County Owls Monday. Game time for the ninth graders will be at 6:00 p.m.



Leigh Chandler attempts to steal the ball in the Ozona Cub Tournament as Gloria Pena Alfaro hurries to her defensive post.
Photo by Neal Ulmer

thriller from start to finish as the Ozona lead climbed to 19-12 at the end of the third quarter. But a determined Eldorado charge narrowed the gap to a point with 30 seconds remaining. After missing on numerous one and one free throw attempts, the Cubettes' Fielder made the first end of her attempt giving the young Lady Lions a two point cushion. Pena-Alfaro stole the ball at mid-court and drove for a lay up as time ran out, giving the Cubettes a 24-20 victory, and a championship trophy.

McCamey finished the tournament with a 30-20 win over Sander-son and taking home the 3rd place trophy. Reagan County, who had lost to Eldorado in the opening round, came back to defeat Sonora in a hard fought 31-28 game in the consolation bracket.

"I was real pleased how well the tournament was managed," said Coach Pool, adding "I would like to thank all those who helped with the tournament and the tremendous support we received from the fans."

Ozona Mercantile
Your Family Store



Professional Rodeo Cowboys Association

Wrangler Open 9:00 - 5:30
Headquarters Monday thru Saturday

Come by and see...
1014 Ave. E 392-5571 - 392-2415

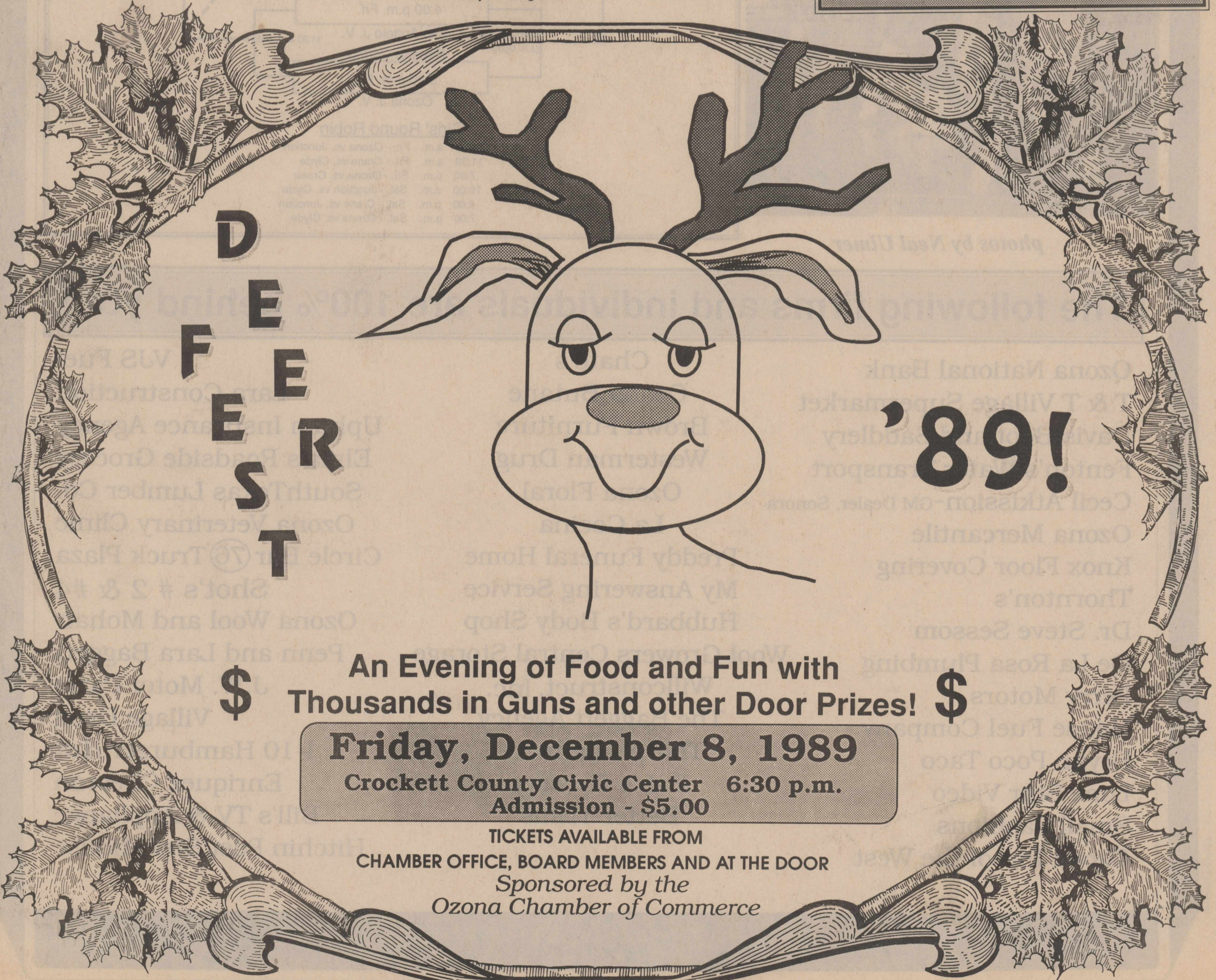

D E E R F E S T

'89!

\$ An Evening of Food and Fun with Thousands in Guns and other Door Prizes! \$

Friday, December 8, 1989

Crockett County Civic Center 6:30 p.m.

Admission - \$5.00

TICKETS AVAILABLE FROM
CHAMBER OFFICE, BOARD MEMBERS AND AT THE DOOR

Sponsored by the
Ozona Chamber of Commerce

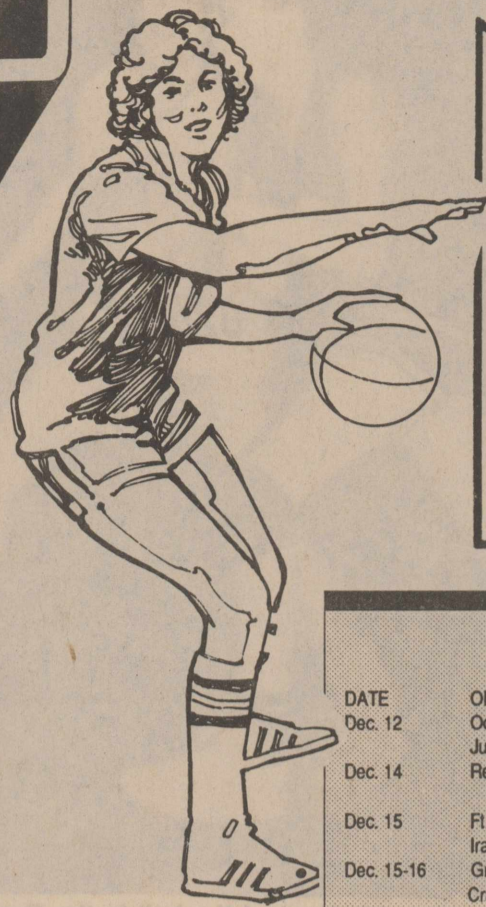

Ozona Lions Basketball



Schedule					
Dec. 11-18					
DATE	OPPONENT	PLACE	TIME	BOYS	GIRLS
Dec. 12	Odessa	Ozona	6:00	JV-V	
	Junction	Junction	6:00		JV-V
Dec. 14	Reagan County	Ozona	5:00		7-8
		Big Lake	5:00	7-8	
Dec. 15	Fl. Stockton	Fl. Stockton	6:00	JV-V	
	Iraan	Ozona	6:30	V	
Dec. 15-16	Greenwood Tournament	Midland	TBA		9-JV
	Crane Tournament	Crane	TBA	9	
Dec. 18	Comstock	Ozona	6:00	9	9

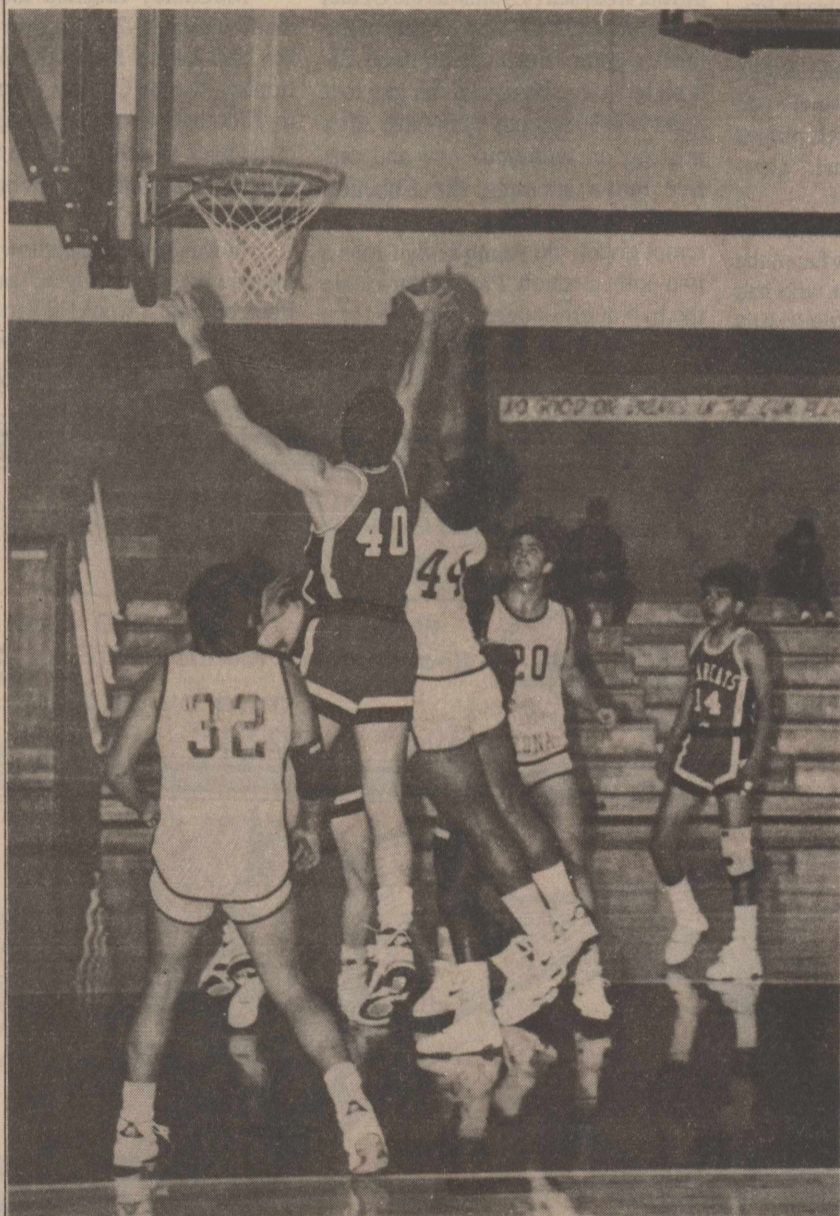
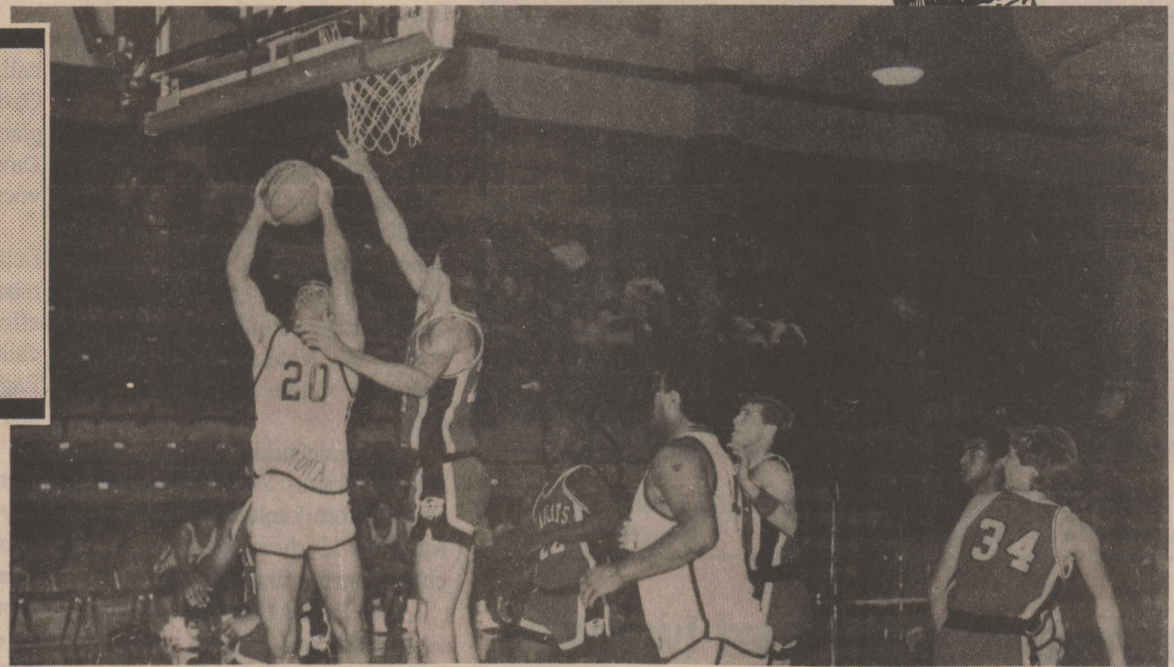

photos by Neal Ulmer

59th OZONA TOURNAMENT December 8 & 9, 1989

Boys' Bracket

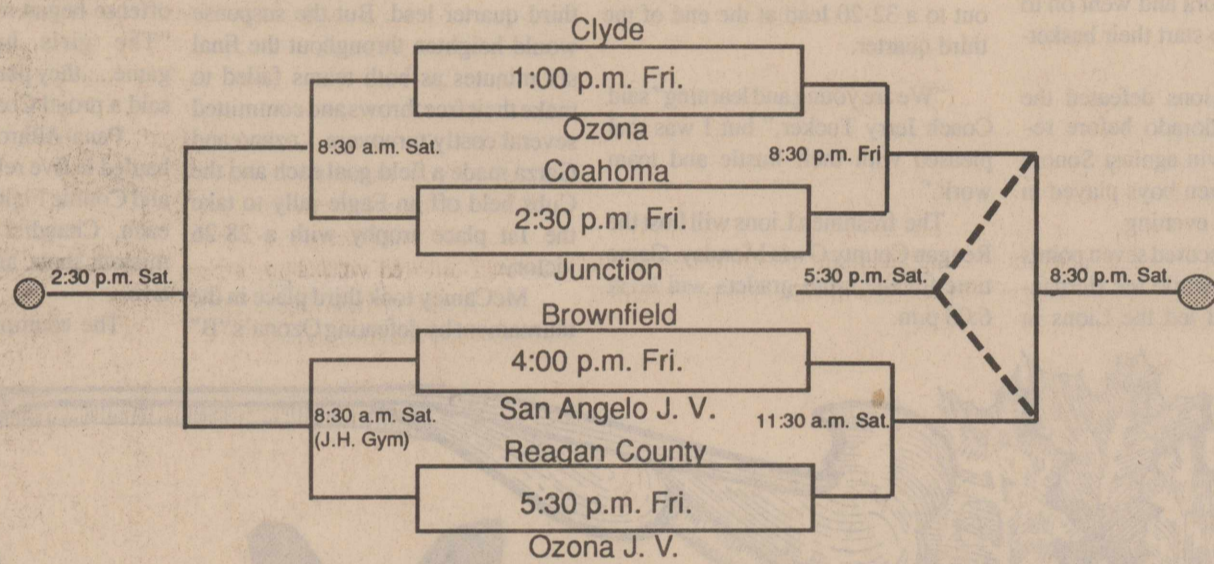

Girls' Round Robin

- 10:00 a.m. Fri. - Ozona vs. Junction
- 11:30 a.m. Fri. - Crane vs. Clyde
- 7:00 p.m. Fri. - Ozona vs. Crane
- 10:00 a.m. Sat. - Junction vs. Clyde
- 4:00 p.m. Sat. - Crane vs. Junction
- 7:00 p.m. Sat. - Ozona vs. Clyde

The following firms and individuals are 100% behind you!

Ozona National Bank
 T & T Village Supermarket
 Davis Boot and Saddlery
 Fenton's Water Transport
 Cecil Atkission-GM Dealer, Sonora
 Ozona Mercantile
 Knox Floor Covering
 Thornton's
 Dr. Steve Sessom
 De La Rosa Plumbing
 Perry Motors
 House Fuel Company
 Bryan Poco Taco
 Lone Star Video
 Small Fashions
 Ozona Inn of the West

Chato's
 Ozona Butane
 Brown Furniture
 Westerman Drug
 Ozona Floral
 La Cocina
 Preddy Funeral Home
 My Answering Service
 Hubbard's Body Shop
 Wool Growers Central Storage
 Willconstruct, Inc.
 The Baggett Agency
 Thorp's Laundry
 B.J.'s Grocery
 Better Trims

VJS Fuel
 Lara Construction
 Upham Insurance Agency
 Elma's Roadside Grocery
 SouthTexas Lumber Co.
 Ozona Veterinary Clinic
 Circle Bar (76) Truck Plaza
 Shot's # 2 & #4
 Ozona Wool and Mohair
 Penn and Lara Baggett
 J.W. Motor Parts
 Village Drug
 I-10 Hamburger Hut
 Enriquez Chevron
 Bill's TV & Appliance
 Hitchin Post Steakhouse

Varsity girls claim consolation

By Sarah Pullen
STOCKMAN SPORTS

The Ozona High School varsity girls competed in the Irion County Basketball Tournament Nov. 30-Dec. 2. During the course of the tournament, the Lady Lions had one loss, and managed two victories, which brought them home with the consolation championship trophy.

In the first game on Nov. 30, the girls were defeated by Menard 68-40.

Leading in points for this game was Stacy Berry with 13 points. She was followed by Tammy Arrott with 10 and Kim Coy with 5. Mikki Ramirez had 3 assists during this game, and Haley Carson had a total of 8 rebounds. Other leaders in rebounds were Stacy Berry with 6, Misty Fowler with 5, and Kim Coy with 4.

After that first game, however, the Lady Lions' luck began to change, as in the second game against Eden, the Ozona girls had a 42-33 victory. Misty Fowler scored 10 points during this game which made her high point. Other high point scorers were Off

Rios with 9 and Kim Coy with 8.

Tammy Arrott led with 9 rebounds throughout the course of the game and was followed by Haley Carson and Misty Fowler who each had 5 rebounds. Lety Dominguez had 3 assists during this game.

"We played as poorly as we could play on Thursday," said Coach Frank Hughey, "but we came back with two good games on Friday and Saturday."

In the final game against Water Valley, the Lady Lions were again victorious as the score was 47-25. This victory gave the girls the consolation trophy for the tournament.

Leading scorers for this game were Haley Carson and Kim Coy who scored 11 and 10 points respectively. Carson also led in rebounds with 7 and was followed by Stacy Berry who had 6 rebounds during the course of the game. Lety Dominguez led in assists with 4.

This coming weekend, the Lady Lions will play in the Ozona tournament, held at Davidson Memorial Gym and the Ozona Junior High School Gym, beginning Thursday afternoon and continuing until Saturday evening.

Registration open for local SAT test

Registration for the local SAT test is now open. Juniors and seniors from Ozona who plan to attend any two year or four year college should register for the January, 1990 exam, to be given here in Ozona on Jan. 27. The registration deadline is Dec. 22, 1989. Please see Jack Probst, counselor, for a registration packet. Mr.

Probst says, "Any of our upper classmen who have not taken the test or who might wish to improve their scores should register as soon as possible." The cost of the test will be \$14.50 and will need to be sent with the application to the College Board in New Jersey.

Lions blast into season

by Charles Wood
STOCKMAN SPORTS

The Lions began their basketball season in a considerable rush this year due to the extra-long football season. Even so, the 1989-90 basketball season looks quite promising. Four games have already been played, and the Lions performed very well in all of them.

Tuesday, Nov. 28, Ozona played their first game in Iraan. The Lions won this contest 45-28. Coach John Curry commented on Sunday that "we had a good game against Iraan. Our boys were able to pick up the game with very little preparation."

George Ybarra led the scoring with 9 points altogether. Lalo Rodriguez followed with 8 points, and Chris Denman made 7 points during the game.

The second game was played Thursday, Nov. 30, against Junction in the first round of the Sonora tournament. Ozona won, with a score of 59-32. Denman led the pack, scoring 22 points during the game.

The third game was a valiant but unsuccessful struggle against Sonora in the second round of the tournament. Ozona lost with a score of 42-40. According to Coach Curry, the Lions fought hard and skillfully despite the loss, making up an 8-point deficit during the fourth quarter. This tied the score and put the game into overtime. The Lions had one last chance to win, but missed the shot.

George Ybarra led in scoring with 13 points. Lalo Rodriguez and Chris Denman followed with 11 points each.

The fourth game was a Sonora tournament match against Ballinger

SWTSU ag scholarships offered

Southwest Texas State University established the Department of agriculture in 1947. Since that time, the department has grown substantially and now has about 350 young people enrolled in quality programs in several areas such as agriculture business, agricultural education, agricultural mechanics, horticulture, plant and soil science, animal science, production and management, agricultural journalism, and range management.

Scholarships made possible through the generosity of the Houston Livestock Show and Rodeo and the San Antonio Livestock Exposition are available for qualified students who major in agriculture. The agriculture faculty is interested in students with good records of academic performance who need financial help to continue their education. Other criteria considered by the selection committee include rank in high school graduating class, SAT/ACT scores and

evidence of interest in agriculture as a career.

The number of scholarships awarded each year depends on available financing. Currently the scholarships are awarded in amounts up to \$1500. per year and are paid on a semester basis. Requirements for entering freshmen are a minimum of 18/800 on ACT/SAT and/or in the upper 25% of the class, and three letters of recommendation. Spring funding for returning students requires at least a 2.5 gpa for work attempted for a full time student in the fall semester. The scholarships are awarded for one academic year, and new competition for each new year.

Please check with Jack Probst, counselor at Ozona High School for an application. The applications must be on file with SWTSU by March 15, 1990.

*Vannoy

(Cont. from pg. 1)

Grace Williams, Paula Bailey, Jim Bob Bailey and Sunny Jon Bailey and Katharine Durham.

Sadie Davidson, Kathy Mayfield and Paula Bailey served as judges for the event, which was held at Prude Guest Ranch at Fort Davis. Approximately 160 4-H'ers were entered in this year's district event.

Crockett County National Bank sponsored the first district lamb award, a \$100 savings bond, which was won by Wendi Skelton of Big Lake.

Jimmie Lott
would like to be
your druggist.

Westerman
Drug
392-2608



FALL & WINTER CLOTHES

20% & 40% OFF

I-10 & TAYLOR BOX RD.

NEW SHIPMENT OF STERLING SILVER AND HANDMADE INDIAN JEWELRY

Good selection of WESTERN BELTS 50% off	Large selection of Southwest pottery
--	--------------------------------------

CIRCLE BAR



GIFT SHOP

THE PIZZA PLACE

ON THE SQUARE CLOSED SUNDAY & MONDAY

TAKE OUT ORDERS
Call ahead: 392-585111 a.m. - 8 p.m.

❖ **FROZEN YOGURT** ❖
NEW YORK STYLE CHEESECAKE
(Plain & Chocolate)

<p>LUNCH SPECIAL</p> <p>1 SLICE LARGE PIZZA OF THE DAY AND DRINK</p> <p>\$1.59</p> <p>11 a.m. - 1 p.m. Tuesday - Friday</p>	<p>WEDNESDAY SPECIAL</p> <p>\$2.00 OFF ANY LARGE PIZZA WITH THIS AD</p>
---	--

MARSHA CANNON
392-3166
DUANE ARMUO
392-5081

Body Shop

OZONA'S FITNESS CONNECTION

CALL THE BODY SHOP for business hours
Start or improve YOUR fitness program with us!

WEIGHT LOSS

BODY SHOP
Parabody
Free Weight
Equipment

WEIGHT GAIN

NEO-LIFE
A.M.A. Approved
Doctors Diet
Nutritional Supplements
•Vitamins•Minerals•
•Protein Drinks•
•Kwik Meal Bars•

RATES - \$5.00 - Daily
\$20.00 single person, monthly
\$30.00 couples, monthly

Village Shopping Center
392-5081

Aerobics Classes
MONDAY - TUESDAY - THURSDAY
\$20.00 per month
Instruction by Alicia Gonzales

Contact Len Hillman

for fast service on any Cecil Atkission business.



LEN HILLMAN - SALESMAN
Home-392-5431 102 Ave. K Ozona,

Chevrolet • Oldsmobile
Buick • Pontiac
SONORA, TEXAS

WHEN THE PRODUCTS ARE SIMILAR, THE DEALER MAKES THE DIFFERENCE

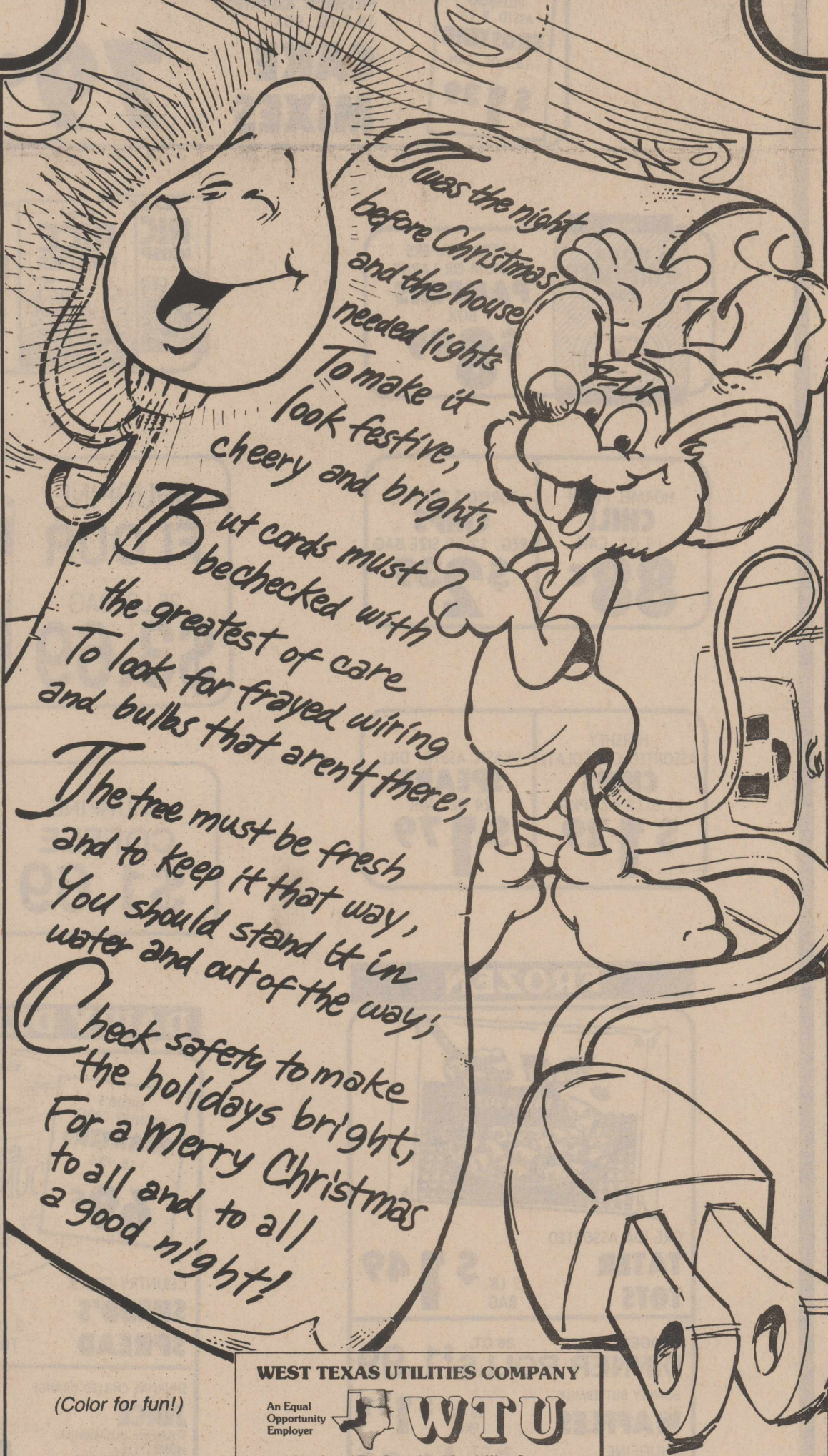

I was the right before Christmas and the house needed lights To make it look festive, cheery and bright;

But cards must be checked with the greatest of care To look for frayed wiring and bulbs that aren't there;

The tree must be fresh and to keep it that way, You should stand it in water and out of the way;

Check safety to make the holidays bright, For a Merry Christmas to all and to all a good night!

WEST TEXAS UTILITIES COMPANY

An Equal Opportunity Employer



A Member of The Central and South West System

(Color for fun!)

Remember REDDY Supplies the energy - but only YOU can use it wisely!



PRODUCTS OF
MOUNTAIN DEW
AND PEPSI COLA
6 PK. 12 OZ. CANS

\$1.58



SHURFINE
MARGARINE
1 LB. QUARTERS

3/\$1



FOLGER'S
COFFEE
13 OZ. BRICK

\$1.69



KRAFT
SALAD
DRESSING
16 OZ.

99c

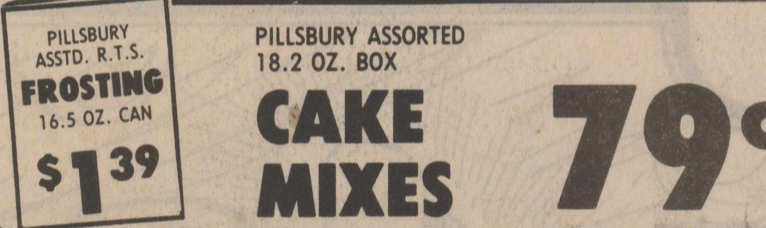

PILLSBURY ASSTD. R.T.S.
FROSTING
16.5 OZ. CAN
\$1.39

PILLSBURY ASSORTED
18.2 OZ. BOX
CAKE MIXES 79c



ULTRA DIAPERS
MEDIUM OR LARGE
PAMPERS
BOX
\$8.99



RIC KRISP
RICE KRISPIES
KELLOGG'S CEREAL-RICE
KRISPIES
13 OZ. BOX
\$2.29

HORMEL PLAIN
CHILI
19 OZ. CAN
88c

DORITO'S TORTILLA
CHIPS
REG. \$2.99 SIZE BAG
\$2.39

SHURFINE
FLOUR
25 LB. BAG
\$3.69



HERSHEY ASSORTED CHOCOLATE
CHIPS
11.5-12 OZ. PKG.
\$1.29

VLASIC ASSTD. DILL
SPEARS
24 OZ. JAR
\$1.79

SHURFINE
COFFEE
\$1.69

U.S. NO. 1 RUSSET
POTATOES
5 LB. BAG
69c

RED RIPE
TOMATOES LB. **43c**

FRESH PICKED
WALNUTS LB. **\$1.19**

FRESH GREEN
BELL PEPPERS LB. **59c**

U.S. NO. 1
D'ANJOU PEARS LB. **59c**

JEWEL GREEN
TANGY LIMES 3 FOR **25c**

FROZEN



ORE-IDA ASSORTED
TATER TOTS
2 LB. BAG **\$1.49**

RHODES 36 CT.
DINNER ROLLS **\$1.99**

DOWNEY BUTTERMILK
20 OZ. PKG. **WAFFLES** **\$1.19**

SHURFINE 24 CT.
BOMB POP JR. **\$1.69**

DAIRY DELIGHTS



SHEDD'S COUNTRY CROCK
QUARTERS
1 LB. PKG. **69c**

COUNTRY CROCK
SHEDD'S SPREAD
3 LB. TUB **\$1.79**

SHURFINE CHILLED ORANGE
JUICE 64 OZ. JUG **\$1.59**

SHURFINE BUTTERMILK/
HOMESTYLE **BISCUITS** 5 7.5 OZ. CANS **\$1.00**

SHURFINE HALF MOON COLBY/CHEDDAR
CHEESE 10 OZ. PKG. **\$1.89**

TABLETS EXTRA STRENGTH
TYLENOL 100 CT. BTL. **\$5.49**

ASSORTED SHAMPOO
CONDITION 15 OZ. BTL. **\$1.39**

ASSORTED-AFTER SHAMPOO
CONDITION II 15 OZ. BTL. **\$1.39**

ASSORTED HAIRSPRAY
CONDITION 7 OZ. BTL. **\$1.39**

ASSORTED TOOTHPASTE
COLGATE 5.4 OZ. TUBE **\$1.39**

VICKS
NYQUIL 5 OZ. BTL. **\$1.39**

THORN

THRIFT

WE ACCEPT-FOOD STAMPS... WE RESERVE THE RIGHT TO LIMIT QUANTITIES.

\$HOP HE

LOWEST
Meat Prices in Town

LOTS OF MEAT-COUNTRY STYLE

PORK RIBS LB. **\$1.59**

SELECT LEAN TRIM CENTER CUT

PORK CHOPS LB. **\$1.99**

WILSON'S TENDER LEAN

SMOKED PORK CHOPS LB. **\$2.29**

RECIPE READY LEAN BONELESS

SIRLOIN PORK CHOPS LB. **\$2.39**

RECIPE READY LEAN BONELESS

PORK CUTLETS LB. **\$1.99**

JIMMY DEAN REGULAR/HOT

PORK SAUSAGE 2 LB. ROLL **\$3.49** 1 LB. ROLL **\$1.79**

GOOCH'S MEXICAN STYLE

HOT LINKS LB. **\$1.49**



LEAN TRIM
PORK
8-11 ASST
\$1.49
LB.



SHURFINE FROZEN ORANGE
JUICE
12 OZ. CAN
99c



BAKE-RITE
SHORTENING
42 OZ. CAN
88c

HERE SHOP NOW!

WILSON'S CERTIFIED



SLICED BACON

1 LB. PKG. **\$1.19**

LEAN TRIM FAMILY PAK
PORK CHOPS
8-11 ASSTD. CHOPS
\$1.49



ARMOUR
VIENNA SAUSAGE
5 OZ.
2/88c

SHURFINE
CHERRY
PIE FILLING
88c

GOLD MEDAL
FLOUR
5 LB. BAG
88c





SHURFINE
GREEN BEANS
3/\$1



40% OFF LABEL
LAUNDRY DETERGENT
TIDE
39 OZ. BOX
\$1.79



CASSEROLE PINTO
BEANS
4 LB. BAG
\$1.79



SHURFINE
GRANULATED
SUGAR
5 LB. BAG
\$1.69



WASHINGTON EX-FANCY DELICIOUS
GOLDEN APPLES
39¢
LB.



SHURFINE
SWEET CORN
16 OZ.
3/\$1



SHURFINE
TOMATO SAUCE
8 OZ.
6/\$1

7 OZ. SIZE **\$1.39** DURACELL SIZE D OR C BATTERIES 2 CT. PKG. **\$2.39**
6.4 OZ. PUMP **\$2.09** DURACELL SIZE 9 VOLT BATTERIES 1 CT. PKG. **\$2.39**
4.59 DURACELL SIZE AAA/AA BATTERIES 4 CT. PKG. **\$2.79**

ANTONS

ETWAY

WE RESERVE THE RIGHT TO LIMIT

- SHURFINE 16 OZ. SAUERKRAUT.....**3/\$1**
- SHURFINE CATSUP.....**88c**
- SHURFINE 26 OZ. SALT.....**3/\$1**
- SHURFINE 32 OZ. LIGHT CORN SYRUP....**\$1.29**
- SHURFINE 20 OZ. PINEAPPLE.....**69c**
- SHURFINE 46 OZ. PUMPKIN.....**2/88c**
- SHURFINE SWEET PEAS.....**2/99c**
- SHURFINE 23 OZ. CAN SWEET POTATOES.....**69c**
- SHURFINE 64 OZ. APPLE JUICE.....**\$1.49**
- SHURFINE 15 OZ. HOMINY.....**3/\$1**
- SHURFINE 16 OZ. PEARS.....**69c**
- SHURFINE TUNA.....**2/\$1**
- SHURFINE PANCAKE & WAFFLE 24 OZ. SQ. SYRUP.....**99c**
- RINSO 38OZ. DETERGENT.....**99c**
- DOVE LIQUID 32 OZ. DETERGENT.....**99c**
- SHURSAVING 8 ROLL BATHROOM TISSUE.**\$1.49**
- SHURSAVING PAPER TOWELS.....**2/\$1**

Cubs stay undefeated Cubettes win first game

by J. L. Tucker
STOCKMAN SPORTS

The seventh and eighth grade Cub teams both came away with victories Nov. 27 in games with Sonora. The eighth grade broke away from their opponent in the second quarter while the seventh rallied in the fourth to win by five points.

With the Colts behind only three points, the Cubs proceeded to keep the lead and stretch it to 11 points by the third quarter's end. Although

Sonora revived somewhat in the fourth quarter, the Cubs' huge lead proved too much, and they won 43-26.

Mike Fay led the team with 14 points and Sammy Hinostrroza added 11 points.

In the seventh grade game, the Cubs took a 15-4 lead in the first half. The second half the Colts fought back and hung close with the score 21-20 and one minute to play. The Cubs managed to hold on to the lead and win 25-20. Chris Sanchez led the team with eight points and J. J. Lozano added six.

by J. L. Tucker
STOCKMAN SPORTS

The seventh grade Cubettes stomped on Sonora Monday, Nov. 27, but the eighth had trouble getting things started and fell, 22-28.

In their game, the eighth grade scored only four points in the first half, allowing Sonora to retain their six point lead. In the final quarter, the Cubettes added five more points and held Sonora to two.

Tiffany Vargas and Jana Cotton each scored six points. Shelby Stuart and Mindy Coates led the team with seven and six rebounds.

On the other side of things, the seventh grade Cubettes merely ran over Sonora and had no trouble in their 36-20 victory. The Cubettes led 20-10 at half and held Sonora to 10 points compared to their 16 point gain in the second half.

Gloria Pena-Alfaro led the team with 16 points; she also had seven rebounds and five steals. J. L. Tucker added eight points and four rebounds.

The Cubettes will host the Reagan County Owls Thursday, Dec. 14, with the seventh grade starting about 5:00 and the eighth grade following. The boys will travel to Big Lake.

LARA CONSTRUCTION, INC.

- Compressor Foundations
- Masonry • Remodeling
- Plumbing • Roofing • Additions

Alejos Lara III 392-3326



Mina's
Nice & Clean
HOUSEKEEPING

WE DO WINDOWS AND LAUNDRY

Mina Harris (915) 392-3233



Lady Lions split games with Iraan

By Sarah Pullen
STOCKMAN SPORTS

The Ozona High School varsity and junior varsity Lady Lions played tight games against Iraan last Tuesday night in Iraan. Although the varsity girls lost 33-49, the J.V. girls managed a 29-26 victory.

In the J.V. game, a sophomore, Veronica Mendoza, had 18 points in the basket throughout the game. Another sophomore, Claudia Avila, had 9 points total throughout the game. Leading in rebounds was Tricia

Hartnett with 12, and following her was Veronica Mendoza with 11 rebounds. Mendoza also led in steals with 7, and again she was followed by Caludia Avila who had 4 steals.

"It was a good game because we got to where we could run our offense better," said Avila.

In the varsity girls' game, Mikki Ramirez, Misty Fowler and Stacy Berry all scored a total of six points each. Kimberlee Coy led in steals with five. The leader in rebounds was Haley Carson with 9 and Teena Tambunga with 4.

Ozona J.V. boys lose opener

by Michael Vasquez
STOCKMAN SPORTS

The Ozona J. V. Lions basketball team lost their first game of the season to Iraan on Tuesday 28, by a score of 24 to 32.

Jamey Parker started the game for the Lions scoring 4 points in the first period, and ended up high point with 8 points. Shane Pridemore also assisted, scoring 7 points for the game.

The halftime score was 8 to 14 in favor of Iraan.

Omar Galindo of Iraan led his team to victory with 13 points, and was aided by Jason Davenport with 6 points.

Ozona just couldn't quite make

the ball fall in the hoop, but the second half proved more productive than the first. Ozona made 16 points for a 24 point final compared to Iraan's total second half 18 points.

The Ozona J. V. boys will play Ft. Stockton on Dec. 5 in Ozona for their second game.

Auto - Fire - Life - Commercial

Elizabeth Upham
Agent

FARMERS INSURANCE GROUP
Symbol of Superior Service

1012 Avenue E. P.O. Drawer U
Ozona, Texas 76943
Bus. - 392-2883 Res. 392-2334

Stockman classifieds mean business!
392-2551



Don't Get Benched
By A Careless Driver
Buckle Up
On the Way to the Game
Texas Coalition for Safety Belts

Ozona Butane
Propane Sales and Service
392-3724

HESTER ENTERPRISES
Trenching & Backhoe Work
Residential & Commercial

SAMMIE L. HESTER
owner/operator

203 Ave. J.
P.O. Box 1542
Ozona, TX 76943

915-392-3325
915-392-2515



PAWNS / PERSONAL LOANS TO \$330
We Buy - Sell - Trade GUNS

We Don't Want All The Business...
JUST YOURS!!!!

We Buy, Sell, Loan, on Diamonds - Gold

TIMELY Pawn Shop
111 W. Concho
655-5685
San Angelo, Texas

We have largest GUN STOCK in San Angelo

Crockett County Hospital

"Out patient Clinic for treatment of injuries and illnesses"

HOSPITAL CLINIC HOURS: DR SIMS
Mon. - Thur.: 9 a.m. - 12 noon / 1 - 5 p.m.
Friday: 9 a.m. - 12 noon

Dr. Owensby will hold a clinic in the hospital every other Saturday from 9:00 a.m. - 12:00

P.O. Box 640 Ozona, TX Appointments 392-2671

COW POKES By Ace Reid



"Wul, we should worry about this sleepin' sickness — it hit Wilbur and his hosses twenty years ago and they ain't got over it yet!"

You can sleep better knowing your home and possessions are insured. See us for home owners insurance!

1114 Ave. E. 392-2606
THE BAGGETT AGENCY



Two of Mankind's Greatest Inventions.

We've relied on this fastenating little device since we were in diapers. But nobody's been sharp enough to invent anything better to keep us from falling apart at the wrong time.

Nobody's invented anything better than a gas furnace, either. Like all the great inventions, it's simple, reliable, and has stood the test of time.



A gas furnace quietly and efficiently does the job it was designed to do ... year after comfortable year.

The point is, no new gadget can do a better job of heating your home. For comfort and efficiency, the most effective invention ever made is a natural gas furnace. Period.

ENERGAS

Visiting

An extended Thanksgiving trip made by A. O. and Mildred Fields and Bobbie Griffin took them to East Texas. The Fields drove to Abilene to pick up daughter Bobbie, then on the Greenville to visit with their son, Dr. Thomas Fields, and his family. Next the trio traveled to Tyler to visit with grandson Gary Griffin.

Bob Wallace and Davy McWilliams both share teaching professions at Ozona Schools. They also share Dec. 3 as a birthday. Hope your day was great. Happy birthday to you both.

Saturday, Dec. 2, a Christmas party was held in San Angelo for foreign exchange students of the area. The party was sponsored by Aspect, the

organization which helps place the students in homes. Attending with Yukika Hata of Japan were John and Sara Hignight and children Jason and Amanda. Attending also were Hiroka Yumigawa of Nara, Japan with Clair and Donna McDaniels and children Megan and Kasi.

Blanche Walker was the birthday lady at her home Dec. 5. Hope you had a wonderful happy birthday.

Visiting with Nell Wester through the holidays were Edward and Marilyn Hernandez and children from Georgetown. Marilyn is the daughter of Ms. Wester and attended schools in Ozona.

Totsy Hagelstein will be a birthday

The Ozona Stockman, December 6, 1989, Page 15

lady at her home Dec. 9. Best wishes for a great day.

Visiting with Mr. and Mrs. Lloyd Winkley over the weekend were son and daughter-in-law, Russell and Melissa Winkley of Abilene.

Brandy Jennings, daughter of Rick and Connie Jennings, will have her second birthday Dec. 11. Happy birthday, Brandy.

Marie Gerlach and daughter Mary Hillman enjoyed a day of getting out Saturday in San Angelo.

Megan McDaniels became one year old Dec. 5. Megan's family honored her with a small party in which she enjoyed being the center of attention.

Tommy, Becky, T. J. and Audrey Young traveled to Junction to do some deer hunting over the weekend. Hope their luck was as good as that of others who ventured out.

Belated happy birthday wishes go

Cynthia Komechak among nineteen students recognized at Sul Ross by Who's Who

ALPINE — Who's Who Among Students in American Universities and Colleges recognized 19 Sul Ross State University students and will include them in the 1990 volume of its publication.

Named Who's Who are Hans Bederski, a senior from Lima, Peru; Shannon Blanchard, a Houston junior; Heather Bradley, Alpine junior; Chuck Cobb, Alpine senior; Mike Cox, Alpine senior; and Bernon Crockett, Hope, New Mexico, senior.

Also Dan Decker, Del Rio senior; Melinda Garland, Sugarland junior; Melinda Pearson whose special day was Dec. 3.

ior; Karen Green, Alpine senior; Lana Grubb, Fort Davis senior; Johnny Kingston, Balmorhea senior; and Cynthia Komechak, Ozona junior.

Also Kenneth Lilley, Alpine junior; Robert Marquart, Fredericksburg graduate student; Mark Murphey, Penwell graduate student; Gregory Rothe, senior from Big Bend National Park; Susan Tanner, Gardendale senior; Julia Thornton, Dallas junior; and Patricia Valdez, El Paso senior.

Students are recognized based on their academic achievement, service to the community, leadership in extracurricular activities and potential for continued success.

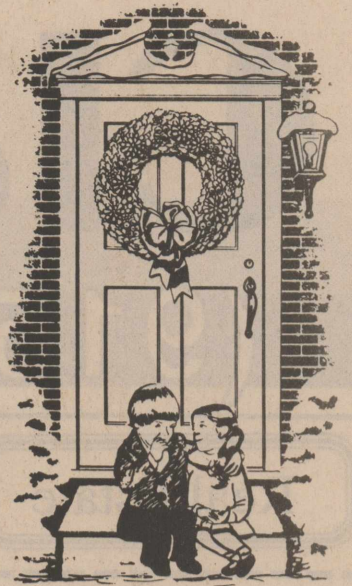

Buckle Up
For Those
Who Depend on You
Texas Coalition for Safety Belts

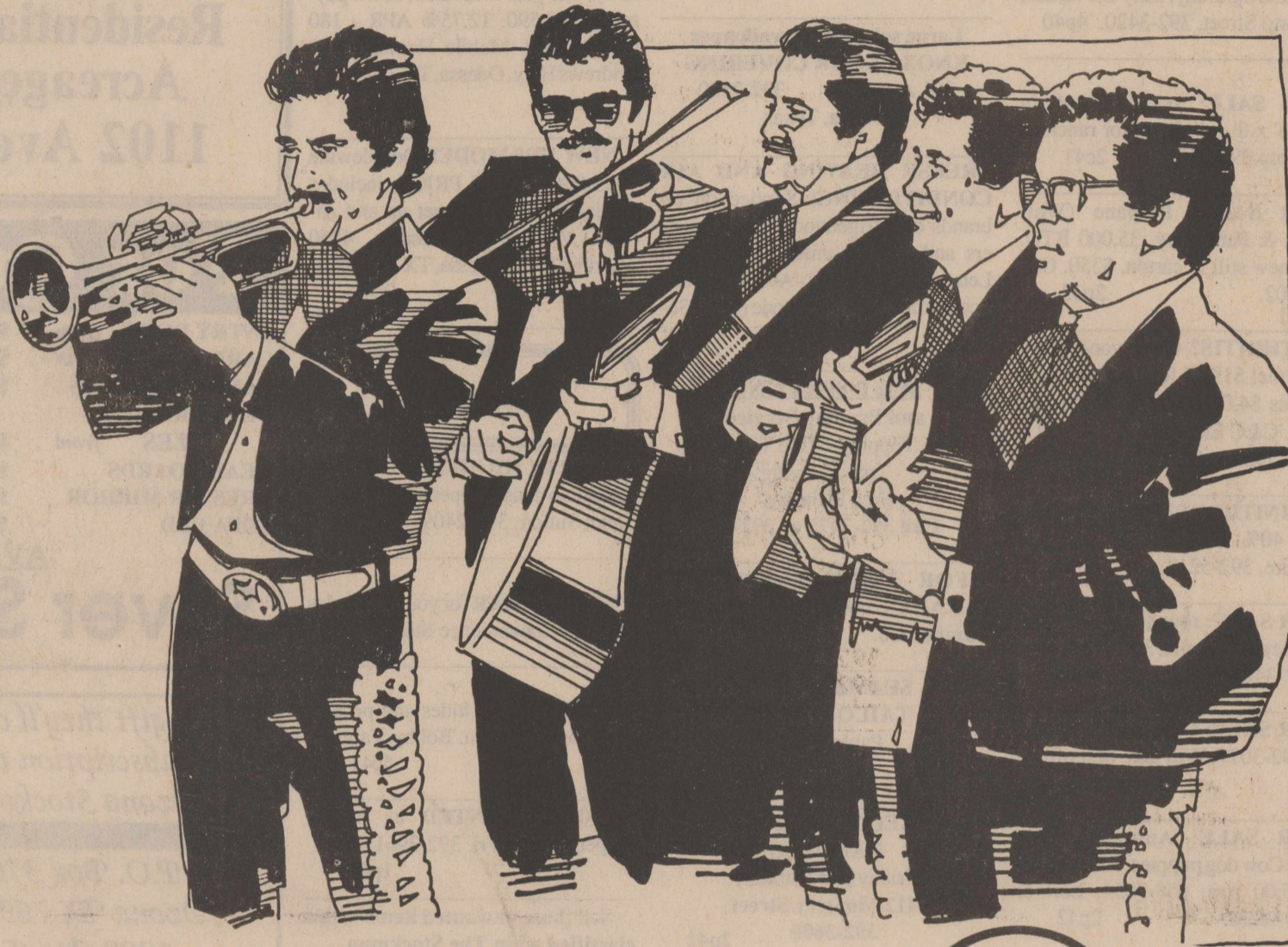

Circle Bar 76 Christmas Extravaganza

December 23, 1989

7:00 p.m. - 12:00 p.m.

Circle Bar 76 Dining Room

MARIACHI: LOS BOHEMIOS

Mexican Buffet

Chicken Enchilada Casserole, Beef Enchilada Casserole, Tacos, Beans, Rice, Guacamole, Hot Sauce, Tostadas, Dessert, Iced Tea or Coffee & Egg Nog
BYOB

\$5.95 ALL YOU CAN EAT \$5.95

Plate Lunches \$5.25 Soup & Sandwich \$2.99

CIRCLE BAR



*Dining Room
Facilities
Available for:*

- * Private Parties
- * Banquets
- * Meetings

EXIT I-10 AT TAYLOR BOX RD.

FRIDAY, SATURDAY & SUNDAY
MENUDO \$1.75

ADDITIONS TO MENU

- Ribeye Steak Enchiladas (Beef, chicken or cheese)
- Franco's Special (Ribeye, rice, beans, enchilada and guacamole)
- Emma's Special (2 boneless, skinless chicken breasts, cheese sauce, rice, beans and salad)
- Beef or Bean Chalupas Cinco Cinco Nachos
- Acapulco Special (Two beef or bean chalupas w/ dip of guacamole lettuce & tomato)

SERVING SUNDAY BUFFET

in our elegant dining room
11:00 a.m. - 2:00 p.m.
\$5.95 Choice of two meats, mashed potatoes and gravy, vegetables and rolls, salad bar **\$5.95**

Classifieds

(915) 392-2551

Your Best Shot

Real Estate

JUST PLAIN NICE & THEN SOME
Two bedroom, one bath, hilltop location & fenced back yard with a great screened-in porch. \$45,000 1201 11th St.

BIG FAMILY???
This four bedroom, three bath brick home could be just right. Beautiful and R.V. shelter, too. 111 Mesquite

MONEY MAKER-was and could be again-Donut Shop and all equipment reduced to \$11,400.

COUNTRY CLUB REDUCED!-\$115,000
3 bedroom, 2 bath brick home Central heat & air.

3 BEDROOM-2 BATH home with fireplace on hillside lot.

REDUCED FOR QUICK SALE
New carpet, new paint, large lot 103 Ave. J. \$21,000.

CHILDRESS REAL ESTATE
392-3634

REDUCED FOR QUICK SALE: by owner, spacious 3 bedroom home on large tiered lot, 108 Ave. L. 392-3849, 392-2323 after 5 p.m. or collect (214) 681-9320

HOME FOR SALE: 4 bedroom, 2 bath, excellent condition. Call for appointment. 392-2334. tf30

REDUCED
Cute 2 bedroom
508 Ave. J
Central Heat & Air
CHILDRESS REAL ESTATE
392-3634 tf37

EXQUISITE: 4 bedroom, 3 bath brick home. Spacious living area, formal dining room, game room. Superb landscaping with pool and fenced backyard. Shown by appointment only. tf31
CHILDRESS REAL ESTATE
392-3634

FOR SALE: 2 bedroom house to be moved. 1106 Ave. J. Call 392-3177. 2c42

REDUCED! 3 bedroom 1 bath, freshly painted, nice carpet. 112 Ave. D. \$29,500. tf31
CHILDRESS REAL ESTATE
392-3634

OWNER SALE: 3352 acre ranch with good facilities, including scales, hydro chute and metal barn. Assumable loan for qualified buyer, no owner financing. Serious inquires only. Call (915) 392-2791. tfc39

FOR SALE: nice 3 bedroom, one bath house, garage in back, central heat and air. \$30,000. 392-2803. 4c40

For Rent

FURNISHED OR UNFURNISHED MOBILE HOMES for rent. Also nice, clean trailer space for rent. Call J.B. Miller Co. at 392-2641

COUNTRY CLUB APARTMENTS for rent. 2 bedrooms. Call 392-3362.

FOR RENT - Large, spacious two bedroom apartment. Available for immediate occupancy. Call Renee Pearl at 392-5545

FOR RENT - Completely furnished Mobile Home \$100 a month
Call 392-3367

For Sale

PIANO FOR SALE: Wanted responsible party to assume small monthly payments on piano. See locally. Call Credit Manager at 1-800-233-8663. 3p40

TAMALES FOR SALE: every Friday and Saturday. Lilly Cervantez, 415 Corto Street, 392-3420. 4p40

FOR SALE: portable walk-in cooler 8' x 8' x 4'. Ideal for ranch or deer camp 392-3232. 2c41

FOR SALE: Propane (Wall Heater) & Panel Ray, 35,000 BTU. Brand new still in carton. \$350. Call 392-2402. 2p42

ARTHRITIS? Greewood Tea - helped me! \$19.95 for 3 months supply, plus \$4.00 S&H Directions included. C&C Enterprises. 392-5217. Box 38, Ozona, TX 76943. 2c42

FURNITURE SALE: 50% off for Cash. 40% if financed. Discount Furniture, 392-5217. 1c42

FOR SALE: round glass top dining table and 4 chairs. 392-2216; after 5 - 392-3425. 1p42

FOR SALE: G.E. Mobile Phone. Call 392-3077. Will take best offer. tf42

FOR SALE: Australian Blue Heeler Cow dog puppies. \$50.00. Call after 5:00 p.m. 658-7054, Lori or Phillip Word. 2p42

Garage Sales

RUMMAGE & CRAFTS
204 Ave. D
Open Daily 9 - 5
4p39

GARAGE SALE: Saturday, 8-5, Lamps, Clocks, Toys, Dolls, Barbie items, Hot Wheels, Games, Bicycle, East Hill across from green tanks. 1p42

Miscellaneous

TOP DOLLAR for your deer hides at B.J.'s Convenience Store. 4c39

ARTIST Johnnye Hoover will paint your favorite subject to your specification in any medium. West Texas landscape and stilllife available for purchase now. 392-3617. 2c42

DEFENSIVE DRIVING returns to Ozona Saturday, Dec. 16. Call 853-2777 for reservations. 2p42

BUYING ALUMINUM CANS. 38 cents per pound. 267 E Largo St. 392-2725. Joe Arredondo. 4p40

Public Notice

CONTRACTORS' NOTICE OF TEXAS HIGHWAY MAINTENANCE WORK
Sealed proposals for LITTER PICKUP AND DISPOSAL in Crockett County, covered by Contracts No. 070XXM2001 and No. 070XXM2002, will be received at the State Department of Highways and Public Transportation's District Office, Loop 306 & Knickerbocker Rd., in San Angelo, Texas 76906-1550, on December 18, 1989 at 10:00 A.M.; and then publicly opened and read.
Proposals and specifications can be picked up at the office of Winston Koerth, MCS, Ozona, Texas. 2c42

Services

ALCOHOLIC ANONYMOUS AND ALANON meetings Monday nights at Lilly Construction, 8:00 p.m. Ph. 392-2054. tf

POLLY'S CAKES
Decorated Cakes Cookies, etc.
211 Mesquite - Ozona, TX
392-3129

Large selection of wallpaper KNOX FLOOR COVERING
201 Ave. E. 392-2180
Ozona, Texas

REESE HEATING AND AIR CONDITIONING: Service on all brands of refrigerated air-conditioners and heating units. Independent Lennox dealer. TACL-A000857. State licensed and bonded. Phone (915) 836-4478. tf

M & B SPRAYING and Pruning Service
Tree Topping - Tree Trimming
- Tree Spraying -
Free Estimates
Call 392-3475 or 392-3604

FOR YOUR RINSENVAC CLEANER come to South Texas Lumber Co. tfc29

SEAMSTRESS & TAILOR WORK
Paula Hester
392-3325

REBECCA MARTINEZ TAMALES
Friday and Saturday
412 Monterey Street
392-3606 2p42

COOKE'S MARKET
Deer processing and storage
Brisket, Beans and Potato Salad
tfn37

Have your Christmas parties set up by the Party Barn!
We help with all phases of planning.
Call Carol - 392-3249

Lost & Found

LOST on Holmsley Ranch one Blue Tick hounddog, 5 years old, neutered. He just recently lost collar, but did not have one when he disappeared. Call 836-4476 collect, if found. \$50 reward. 1c42

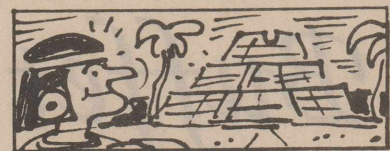

The first highways in the new world were built more than 350 years ago by Inca Indians of South America. At its peak the Inca Empire extended almost 2,500 miles from Columbia to Chile.

Fencing in Your Future? Do it NOW!!

LARGE INVENTORY BEST PRICES

Experienced Fence Crews

Barbed Wire, Net Wire, Steel Posts
Electric Fence Materials
Fiberglass Sucker Rod Posts

Inquire on Special Prices on Cedar Posts (some peeled posts and stays available.)

FAST DELIVERY / FREE CALL
Fencing the Nation since 1947

TWIN MOUNTAIN SUPPLY
In Texas: 800-527-0990
In USA: 800-331-0044
(915) 944-8661

Located: Hwy 67,
5 mi. west
San Angelo, TX



Mobile Homes

FSLIC REPOS-completely refurbished-like new condition. Over 50 homes to choose from. We take trades. A-1 Mobile Homes, 4750 Andrews Hwy. Odessa, TX 332-0881. 2c39

4-BEDROOM-2 bath - payments \$178.90 monthly. Includes 2 yr. warranty, one year insurance, down payment - \$1,590, 12.75% APR - 180 months, A-1 Mobile Homes, 4750 Andrews Hwy, Odessa, TX 332-0881. 2c42

NEW 1990 MODEL Doublewide - \$29,900 - SALE PRICE, includes appliances, delivery, set up and anchors. A-1 Mobile Homes, 4750 Andrews Hwy, Odessa, TX 332-0881. 2c42

Wanted

WE PAY HIGHEST PRICE for aluminum cans, copper and batteries. Glenn Sutton, 392-2409. tfc28

TOPDOLLAR for your deer hides at B. J.'s Convenience Store. 4c38

WE BUY deer hides and pecans. Best prices in town. Bobby Vargas. 5c41

WORK WANTED as house-keeper. Mon. - Fri. 392-3961. 1p41

Sell those unwanted items with a classified ad in The Stockman.

Johnny Childress Real Estate

392-3634 392-5051



Residential-Ranches-Lots Acreage-Commercial
1102 Avenue E, Ozona

For Quick Sale

ENTRY DOOR	from \$15	SOFA CHAIRS	\$20
CARPETS	from \$25	LOUNGE CHAIRS	\$10
LAMPS W/SHADES	\$6	DESK CHAIRS	\$10
DESK/DRESSERS		ROUND PARTY TABLE	\$20
3 SIZES	from \$30	DBL. BED (BOX SPRING MATTRESS)	\$70
HEAD BOARDS	\$10	DBL. BED WITH IRON FRAME	\$80
DRESSER MIRROR	\$10		
SOFA BED	\$40		

AVAILABLE AT

Silver Spur Motel

Give a gift they'll cherish...
A subscription to the
Ozona Stockman

\$14.00 per year in
Crockett County

P.O. Box 370
Ozona TX 76943
1000 Ave. E.

\$16.00 per year
out of town

Two events that should not be missed on Friday, December 8!

Western Art Show & Sale by R.R. Ruiz

The Sheepshearing Artist
in the Main Bank Lobby
from 10:00 to 12:00 a.m. & 1:00 - 2:00 p.m.

Deer Fest '89

Game dinner and raffle extravaganza at the Civic Center starting at 6:30 p.m.
TICKETS AVAILABLE AT THE DOOR

We will see you there!

Ozona National Bank



Home Owned - Home Directed
P.O. Box 430, Ozona, Texas 76943

Member FDIC