

THE FRIONA STAR

VOLUME 55, NUMBER 35

SUNDAY, JUNE 3, 1979

10 PAGES, PLUS SUPPLEMENT

Star
Lites
By
Bill Ellis



Residents Oppose 30-Day Bird Season

THE RECENT EPISODE at Three Mile Island caused opponents of nuclear energy to pounce on the subject, like a cat on a mouse, virtually demanding an end to the use of nuclear power.

Never mind the fact that in more than 20 years of using nuclear energy, we have yet to have one single solitary death attributed to this field. This is quite a record, and one that no other industry can even begin to match.

Yet, the tremendous amount of publicity that the incident at Three Mile Island received, caused a big "scare" to be cast concerning nuclear energy, and the possibilities of radiation exposure posed by the presence of such power plants.

It has been said that the recent "leak" at the New Jersey plant caused those living near the complex very little in the way of radiation danger, although they may have been scared to death in the meantime.

Radiation absorption is measured by the "Rem," which is the biological effect produced by one roentgen of X-ray. Scientists measure low-level radiation in millirems (one thousandth of a rem).

These people living within a half mile of Three Mile Island, for example, received only an extra 83/millirems during the recent turmoil.

By comparison, a dental X-ray of your entire mouth would give you 910/millirems on your absorption chart. A barium enema would give you 8,000 millirems.

We are finding out that where low-level radiation is concerned, there is virtually no escaping it in our modern world. Many people are exposed to radiation on their jobs, and you can also be exposed by such simple acts as walking into a building made of granite.

In fact, a recent test made at the U.S. Senate subcommittee hearing room showed higher levels of radiation from that building than anything produced near Three Mile Island at the height of its recent excitement. But no one has suggested that we close down the Senate.

It is just that the opponents of nuclear energy have jumped on the subject, and would have us close every such power plant in the nation, without even so much as a hearing. Perhaps a more sensible approach would be in order.

Experts on the subject say that low-level doses of radiation do not present any significant threat of cancer or genetic malformation. In fact, one specialist on the subject, Dr. Edward Radford, chairman of the National Academy of Science, says: "The risks are very small. There is a risk, but it's not the end of the world."

This should be a comforting thought to the people who live in the vicinity of Three Mile Island, and it also should make the opponents of nuclear energy feel a little foolish, but we doubt that it does.

But experts do warn that one of the problems with radiation dangers is that when radium begins to decay, it gives off radon gas, one of the most serious low-level radiation threats.

There may be a problem with "radioactive sludge," the nuclear waste that has been piling up for the past 20 years. It is full of all kinds of deadly poisons that could remain dangerous for 25,000 years, the experts say.

And then there are the homeowners in Colorado, whose homes are built with material from a government uranium mill which was exposing them to unacceptable levels of radon gas.

In the case of the Colorado homeowners, the government paid to have the necessary changes made, and the corrective measures can cost up to \$5,500 per house.

Try praising your wife, even if it does frighten her at first.

--Bill Sunday

Residents of Parmer County are learning, much to their dismay, that the Texas Parks and Wildlife Department has declared a 30-day season for pheasant hunting for 1979.

Spokesmen for the Parmer County Game Management Assn. expressed their opposition to the plan, stating that it "Would ruin the pheasant as a game bird in this area."

"They put in this extended season with no consideration of the residents of this area at all. I would bet that 99 per cent of the residents of Parmer County are opposed to a 30-day season," stated Jack Patterson, county commissioner and longtime game specialist.

The Parks and Wildlife Dept. apparently held a hearing on the proposed change earlier this year at Farwell, but the hearing was not advertised locally, and virtually no one knew about the hearing or the

proposal to lengthen the season until it was too late.

At a meeting of the Parmer County Commissioners this past Tuesday, the organization drafted a letter, signed by every county commissioner, opposing the change. The letter was sent to the Parks & Wildlife Department.

"I can't see why they had the meeting here in our area, apparently wanting local opinion, and then did not sufficiently advertise the hearing," Patterson said. "This will cause a lot of bad feelings between the farmers and hunters. Farmers just don't want to put up with a 30-day hunting season," he continued.

The local pheasant population was started back in 1962-63 when the area was stocked with pheasant hens and cocks. After a few years, a weekend hunting season was held, and later a

nine-day season, spanning two weekends, was instigated.

Under Parks & Wildlife influence, the season was stretched from nine days to 15 three years ago, making the season span three weekends in December.

"We tolerated the 15-day season, but this will just ruin the situation. As much as I like to hunt, I would almost rather drop the thing entirely as to have a 30-day hunting season every year," Patterson continued.

Local officials urge residents to contact Senator Bob Price and Representative Bill Clayton urging them to use their influence in reversing the decision by the Wildlife Department.

Maize Days Dates Set

The dates for Friona's 1979 Maize Days celebration was set officially as September 4-8 at the last meeting of the board of directors of the Friona Chamber of Commerce and Agriculture.

The dates for the annual civic affair are set to coincide with the schedule for the company which furnishes rides in the park during the event.

The date for the 1980 Chamber banquet was also announced. The banquet will be held on Friday, January 26.

The next board meeting will be on Tuesday, June 12 at Carl's Parmer House Restaurant. Chamber members are urged to attend, and bring their ideas and suggestions.

Gun Club To Sponsor Trap Shoot

The Friona Gun Club will sponsor a Merchandise Shoot on Saturday and Sunday, June 2-3. Entry fees will be \$2.00 and everyone is invited to attend.

The shooting range is located one mile east of Friona, on Highway 60.

The shoot will start at 8 p.m. each day.

Commissioners Court of Parmer County by James P. Fortenberry, Judge

RESOLUTION PASSED

Court Urges Support Of Vietnam Veterans

The Parmer County Commissioner's Court passed a resolution at its latest meeting, proclaiming Vietnam Veterans' Week. Similar proclamations have been made by Governor Bill Clements and President Carter.

The proclamation read: "Since the week of May 28 through June 3, 1979 has been proclaimed Vietnam Veterans Week by the president of the United States, and

since the Commissioners Court of Parmer County in a previous meeting proclaimed the above dates as Vietnam Veterans Week, which is recorded in the minutes of the court, upon motion duly made and seconded, the following resolution was adopted unanimously:

"Resolved that the Commissioners Court of Parmer County express its deep appreciation to those who served our country during the Vietnam Conflict.

"Understanding the necessity to stand by our county in times of need and honoring those who did so in the Vietnam Era;

"It is further resolved that all organizations be requested to recognize those members who served in the Vietnam Conflict; and, that all individuals of Parmer County be requested to call one or more Vietnam Era veteran and express appreciation to them for their service to our country.

This Court honors and respects the Vietnam Veteran, and requests all citizens of Parmer County give special recognition to them during this week.

New Officers Are Elected

New officers were elected recently by the Friona House of Friendship.

Wilda Millican was named president, Estis Bass is vice president, Velma Lovett is secretary, and Pat Fallwell was named treasurer.

The group enjoyed games following the business session. A final decision was also made on the central heating system, plus the location of the office and closet in the organization's new clubhouse, which is under construction.



VALEDICTORY...Donna Rector is shown as she gave the valedictory address at the graduation exercises for the Friona High School Class of 1979 last Friday night.



SALUTATORIAN...Jan Mason is shown delivering the salutatory address during the commencement exercises for Friona seniors last Friday.



HISTORIAN...Chris Barnett, third-ranking graduate, gave the class history as part of the graduation exercises last Friday.



ACCIDENT VICTIM...Melba Smiley is shown moments after breaking an ankle while sliding into third base in a softball game here Wednesday night. Fire Chief Ralph

Shirley attends Mrs. Smiley while waiting for the ambulance. The local resident was taken to Amarillo, where she underwent surgery for the bad fracture. (Photo by Stanley Ellis)

Weather Turns Cold; Hail Hits Lazbuddie Area

The Friona area has had a week of unseasonably cool, wet weather, with some damage recorded Memorial Day evening from a hailstorm which slashed the southeastern part of the area.

With temperatures in the 50s and 60s most of the week, agriculture observers were wishing for warmer weather, which the plants need for a good start.

Some portions of the area received beneficial moisture during the week. Another system which came in on Wednesday triggered showers during the early morning hours on Thursday, and left the area dripping to a slow drizzle all day Thursday.

But the Lazbuddie area counted substantial damage from the Monday night storm, which wiped out young cotton and corn crops, and also ruined ready to harvest wheat and barley.

Bobby Broyles, who farms near

Lazbuddie, said his cotton was off to a good start, but was completely destroyed by the late-afternoon hail storm, which stacked up hail several inches deep in lister ridges and barrow ditches.

A neighbor of Broyles' Raymond McGeehee, also reported considerable hail damage, and it was thought that the hail affected a large percentage of the farmers in the southeastern part of the county.

The city of Friona received only a sprinkle from the cloud, but just three miles southeast, the Terry Copley residence measured two inches of rain in a short time on Monday.

The Lazbuddie area received another rain on Thursday, when most farmers in that vicinity were needing open weather so they might replant their crops.

Temperatures

Date	Hi-Low
Saturday, May 26	70-53
Sunday, May 27	75-56
Monday, May 28	81-58
Tuesday, May 29	85-56
Wednesday, May 30	91-58
Thursday, May 31	71-54
Friday, June 1	59-50

'Phone Company Hits Milestone

General Telephone Company of the Southwest has over 1.5 million telephones in service, according to O.D. Hearn, Brownfield division manager.

General installed its one-millionth telephone in May 1973 at Texas A&M University. The one million milestone was reached after almost 47 years of operation, the company being incorporated in June 1926.

However, the trip to the next million appears to be much shorter as it has taken less than six years to install another half a million, and projections on company growth indicate the 2nd millionth telephone will be installed by late 1982.

General Telephone serves over 400 exchanges made up of over 990 communities with over 2.2 million in population in 59,000 square miles of area in Arkansas, Oklahoma, New Mexico and Texas.

Friona Flashbacks

.....from the files of The Friona Star

50 YEARS AGO--JUNE 5, 1929

It now appears to be an established fact that Friona will be the center of a system of rural telephones, which will be connected with and operated by the same system that will be in use in the city.

It is reported on the best of authority that Friona will have a first class and strictly up-to-date "M" System store, which will be open for business on or about the fifteenth of June.

45 YEARS AGO--JUNE 8, 1934

Mrs. A.H. Boatman was appointed to membership on the Texas Centennial Advisory Board as one of four members from Parmer County, according to a letter Mrs. Boatman received from Will H. Mayes, temporary secretary of the Texas Centennial Commission.

40 YEARS AGO--JUNE 9, 1939

The City of Friona is soon to have a new fire truck, which is now being built and nearing completion in the work shops of Reeve Chevrolet Company, with Charles Bainum, one of the firemen, doing and supervising the work of building.

35 YEARS AGO--JUNE 9, 1944

On Saturday afternoon, June 10, Friona will be featured on a historical broadcast over station KGNC by Miss Laura V. Hamner of Amarillo.

Some time Monday afternoon, Mrs. Pearl Kinsley was uninjured when her car overturned while enroute to Friona. Mrs. Kinsley sustained only a few minor bruises, but the car was considerably damaged.

30 YEARS AGO--JUNE 10, 1949

On Monday of last week, Day Brothers, house movers of Hereford, arrived in Friona and began preparations for moving the home of Rev. Tommie Allen, pastor of the First Baptist Church, from its old location to make room for the proposed new auditorium to be built on the ground it formerly occupied.

25 YEARS AGO--JUNE 4, 1954

The city has begun making street markers for Friona, a badly needed commodity to assist strangers in finding addresses. The Lions Club set up 64 of the markers on Wednesday, and still have 52 to place on the corners.

Thirty-four cars of a Santa Fe freight train were derailed Sunday

at the east switch at Summerfield. The cars were filled with perishable goods. Five or six carloads of fruit were taken to Hereford to reload on other cars.

20 YEARS AGO--JUNE 4, 1959

W.O. (Bill) Wright, 39, drowned sometime Friday night following an unexplained accident at Lake Conchas in New Mexico.

Hail cut a destructive swath through Parmer County, in the shape of a new moon from Rhea to east of Hub. Hail was stacked up a foot deep next to buildings on some farms following the storm.

15 YEARS AGO--JUNE 4, 1964

Peggy McNair, who is the reigning "Miss Wool of Texas," paid a visit to the Otho Whitefield sheep ranch this week. Whitefield is an official in both the Columbia Sheep Breeders of America and the Texas Columbia Breeders.

10 YEARS AGO--JUNE 5, 1969

Joe Bob Mann, the son of Mr. and Mrs. Joe Mann of Friona, was aboard the USS Frank E. Evans when it was cut in half by an Australian aircraft carrier in a pre-dawn collision early Tuesday morning.

Airman Kirk Matlock, grandson of Mr. and Mrs. E.D. Matlock of Friona, is in a hospital in Japan after suffering a hand wound while in Vietnam, it was reported after the Matlocks talked with Kirk by telephone this week.

5 YEARS AGO--JUNE 2, 1974

A contract for the Highway 214 project, to include widening the road and construction of an overpass, was awarded this week by the Texas Highway Department.

Kay Riethmayer, daughter of Mr. and Mrs. W.R. Riethmayer of Route 3, Friona, has been placed on the Dean's Honor Roll at Lubbock Christian College for the spring semester of 1974.

Darrell Mason, a junior student at New Mexico Military Institute, compiled a 3.7 grade point average on a 4.0 grading system for the semester just ended.

Book Talk

By NELSON LEWIS

"Forewarned is Forearmed."
--Respected Adage

Notorious Ladies of the Frontier
--by Harry Sinclair Drago

The facetious use of the word "ladies" is Mr. Drago's gentlemanly attempt to soften the stroke of doom. This writer's first impression--aside from historical appreciation--was that here again is a worthwhile record but one not to be read by young folks. Then I saw "Scared Straight." This book falls into the category of shock treatment. Risque subject, yes, but the warning is very plain; a life spent in ignoring moral standards is a downhill trip on greased skids. There is no glamour to be found in disease, poverty or inhuman treatment not to mention loneliness and loss of self-respect.

Mr. Drago does an excellent job of honest description without resorting to any semblance of bad language. Neither does he preach nor moralize, he simply tells it like it was.

History buffs will enjoy his stories of the rise and fall of western mining towns. Fortunes were made and squandered as were thousands of lives, too bad that immorality did not die out with the pay dirt.

Write Your Congressmen

The Honorable Jimmy Carter
President of the United States
The White House Washington, D.C. 20500
(Dear Mr. President)

The Honorable John Tower, M.C.
United States Senate Bldg.
Washington, D.C. 20510
(Dear Senator Tower)

The Honorable Lloyd Bentsen
United States Senate Bldg.
Washington, D.C. 20510
(Dear Senator Bentsen)

The Honorable Kent Hance
U.S. House of Representatives
Washington, D.C. 20515
(Dear Congressman Hance)

Formby Named "Man Of Year"

The staff of Texas Tech University's yearbook, "La Ventana," has announced that Regent Clint Formby of Hereford had been named its "Man of the Year" for 1979. His picture will be on the cover of the "Texas Business Magazine" section of the yearbook.

Formby was presented the original art work of the cover at a meeting of the Texas Tech Board of Regents in regular session Friday, May 11. Presentation of the framed art work was made by co-editors Beverly Jones of Dallas and Elizabeth Edwin of El Paso.

Formby is the 21st person to receive the coveted honor bestowed by "La Ventana" and the first regent and non-member of the university faculty or staff to receive the recognition.

Campus student organizations nominate men or women for the distinction, and the honoree is selected by the yearbook staff of approximately 20 persons.

Selection is based on "outstanding contributions to Texas Tech and its students" and the honor is bestowed on a "person who has had unusually good relations with students." Formby was nominated by the Mass Communications Student Advisory Committee.

Serving his second six-year term as a regent, Formby is a past board chairman. He is a 1949 graduate of

the university with a major in government and minor in speech-journalism.

He is partner and managing director of radio stations KPAN-AM and-FM, Hereford; KLVY, Levelland; KTEM-AM and KPLE-FM, Temple; and KTBB, Tyler.

He is a member of the boards of directors of the West Texas Chamber of Commerce, National Associated Press and National Broadcast Education Association.

Letter To The Editor

Dear Bill,

We sure enjoy the Friona Star. You never realize what a good paper it is until you move.

We miss everyone in Friona, and this keeps us in touch. We especially enjoyed the Senior edition.

It was good to see and read about all the kids we've seen grow up. They are all a fine group of young people.

Danny & Dwain Menefee

(Editor's note: Thanks for the compliment. You know, it's the same way with people--you never miss them until they're gone. Our best wishes to the Menefees. It was good to hear from you. B.E.)

Kelley Rites

Are Conducted

M.C. Kelley of Elk City, Oklahoma died last Thursday in the Deaconess Hospital in Oklahoma City with a heart attack following surgery.

Services were held at the First Baptist Church in Elk City.

He is survived by his wife and one daughter, Bessie Faye Thornton of Elk City and a grandson, Stan Hall of Detroit, Michigan.

The Kelleys were well known in the Bovina and Friona area.

The Friona ★ Star
(Publication Number-USPS-210-800)
Published Every Sunday
At 916 Main Street
Friona, Texas 79035
Second class postage paid at Friona, Texas 79035

SUBSCRIPTION RATES
Parmer County, adjoining counties,
\$7.50 per year. Elsewhere, \$9.00 per year.

Bill Ellis, Editor & Publisher
Vickie Copley, Production Supt.
Laura Nell Coffey, Bookkeeper

Lois Norwood Says. . . .

OUR PROFESSION

Is painting a brighter future for you by providing the proper protection for your property, home, car and business. And, when you have a claim, we arrange prompt payment. Please call us and arrange for an appointment at your convenience.



Ethridge-Spring Agency Inc.

Welcome To Friona

Houser Grocery

Reeve Chevy-Olds

Keep That Great GM Feeling With Genuine GM Parts

Rockwell Bros. & Co.

Friona State Bank

Horn-Clayton Ins.

Friona Ford Sales

Ethridge-Spring

These Sponsors Welcome You To Friona's Churches

Church Chuckles by CARTWRIGHT



"That new sign sure doesn't seem to be working!"

FIRST BAPTIST SIXTH AND SUMMIT-- REV. C.H. MURPHY	UNITED PENTECOSTAL CHURCH 5TH AND ASHLAND--
CALVARY BAPTIST 14TH & CLEVELAND-- MURLE ROGERS, PASTOR	6th ST. IGLESIA de CRISTO 408 W. SIXTH
TEMPLO BAUTISTA 4TH AND WOODLAND-- REV. DONNIE CARRASCO	6th ST. CHURCH of CHRIST 502 W. SIXTH--H.D. SIMMONS, JR.
ST. ESTHER'S BAPTIST CHURCH 5TH AND MAIN-- REV. I.S. ANSLEY, PASTOR	10th ST. CHURCH of CHRIST 10TH AND EUCLID--
FRIONA UNITED METHODIST CHURCH 8TH AND PIERCE-- REV. JIM BOSWELL	FIRST ASSEMBLY of GOD 10TH AND ASHLAND--JIM BOND
REDEEMER LUTHERAN CHURCH 13th - Virginia 8:30 a.m. Herman J. Schelter (Vacancy Pastor) Larlat, Texas	TEMPLO "MARANATHA" SPANISH ASSEMBLY of GOD 301 GRAND--RAFAEL RODRIGUEZ
UNION CONGREGATION CHURCH EUCLID AT 10TH-- REV. SKIP IRNIC	ST. TERESA'S CATHOLIC CHURCH 10TH AND CLEVELAND-- RONALD McGOVERN, S.A. ADMINISTRATOR

Seek and you'll find all the treasures in life!

Attend Church Regularly!

REMEMBER WHEN?



Chances are you can't remember when the old Escarbada Ranch headquarters looked like the above photo, but no doubt many of you can remember the old ranch house, formerly located northwest of Friona, but now restored at the Texas Tech Museum in Lubbock. Houses have changed, and we have changed. But one thing which has not changed is our desire to give you the best banking service possible. Ask about our ESP (Extra Special People) program, if you have not already.

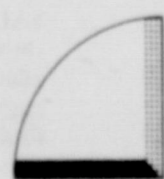

FRIONA STATE BANK



TAMMY KAYE FAIRCHILD, daughter of Mr. and Mrs. Larry Fairchild of Adrian graduated from Adrian High School Tuesday night, May 29. She was an honor student with a grade point average of 93.22. She left Thursday, May 31, along with the other seniors and three sponsors, for a trip to Honolulu, Hawaii for nine days. She plans to attend Texas Tech University this fall and major in chemical engineering. She is the granddaughter of Mr. and Mrs. Otis Neel and Mr. and Mrs. E.L. Fairchild, all of Friona.



DARCY DEE RENNER graduated from Jal High School, Jal, New Mexico on May 21. He attended Jal High School three years, where he was active in golf three years and baseball one year. Darcy attended Friona schools nine years. He is the son of Mr. and Mrs. Cotton Renner, former Friona residents, and the grandson of Mr. and Mrs. Rudolph Renner, Sr. of Friona.

Around The Firehouse

By RICHARD WILSON

Friona firemen were called out at 5 a.m. on Tuesday, May 29. The Budget Motel had a minor fire as the neon light had shorted and caught the roof overhang on fire. The fire was extinguished quickly with only minor damage.

The Fire Department personnel are busy working on the training field. The field is located just east of the City Barn on Eighth Street. This field will be used to train all firemen. The field will consist of a smoke house, a tower, a pit fire, a tank for drafting water and simulated butane fires when completed. The smoke house will be used to train firemen in the proper procedure of air packs and proper breathing techniques.

The smoke eating fireman is a thing of the past as a house fire today could contain several hundred toxic chemicals. The tower will be used to train in the correct use of ladders and the steps to be followed for a rescue from a two or three story building. The oil pit fire will give valuable training in case of an oil spill or tanker fire. The tank for drafting water is very valuable as this would be very likely at a fire in the country where the only water could very well be an irrigation ditch. Several butane tanks have been donated for the use of a simulated butane tank fire.

The new van is complete other than the "Jaws of Life." The department is proud of the van and if anyone would like to inspect it, just drop by the fire station. As the saying goes 'If you don't have a Jaws of Life-get one.' Deposit any amount in the firemen's special fund at Friona State Bank.

Bookmobile Schedule

The High Plains Bookmobile will be in our area on the following dates: Wednesday, June 6--Needmore, 9:30-11 a.m.; Stegall, 11:30 a.m.-12:30 p.m.; and Threeway, 1-2 p.m. Thursday, June 7--Oklahoma Lane, 9-10 a.m.; Rhea Community, 10:45-11:45 a.m.; Friona, 1-1:15 p.m.; and Hub, 1:15-2:15 p.m. Friday, June 8--White's Elevator, 10-11 a.m.; Lazbuddie, 12 noon-1 p.m.; and Clay's Corner, 1:45-2:30 p.m. Saturday, June 9--Farwell, 9-11:45 a.m.; and Friona, 1-3:30 p.m.



SUMMER REUNION

SALE SECOND BIG WEEK!!



Shelf Specials

SHURFINE Dinners	MACARONI & CHEESE	4 7/8 OZ. BOXES	\$1
SHURFINE Dressing	SALAD	32 OZ. JAR	79¢
SHURFINE CANNED Black Pepper		4 OZ. CAN	69¢
SHURFINE RATION HIGH Dog Food	PROTEIN	25 LB. BAG	\$3.29

SHURFINE ASSORTED

Canned Pop

12 OZ. CANS

\$1

THIS WEEK'S FEATURE

Soup Spoon

PER PIECE WITH EACH \$3.00 PURCHASE

33¢

ALL PURPOSE

Shurfine Flour

5 LB. BAG

59¢

BEST BUY IN TOWN! IT'S BROASTED CHICKEN

FOR UNEXPECTED GUESTS WHEN YOU'RE GOING ON A PICNIC OR IF YOU'RE JUST TIRED OF COOKING

French Fries 49¢ Per Order

Also: Corn Dogs, Burritos

247-3343

HEAVY GRAIN FED BEEF BLADE CUT

Chuck Roast

\$1.39 LB.

Slab Bacon **\$1.09** Lb.

SHURFRESH BONELESS Half Hams Sectioned & Formed **\$1.99** LB.

SHURFRESH Sliced Bacon **\$1.29** LB.

SHURFINE SALTINE Crackers 16 OZ. BOXES **2 \$1**

SHURFINE CUT Green Beans 16 OZ. CANS **3 89¢**

SHURFINE Pork & Beans 16 OZ. CANS **4 \$1**

SHURFRESH BEEF FRANKS OR Bologna 12 OZ. PKG. **\$1.09**

SHURFRESH MEAT FRANKS OR Bologna 12 OZ. PKG. **99¢**

SHURFRESH 3 LB. Canned Hams EACH **\$5.79**

SHURFRESH SLICED Bacon 2 LB. PKG. **\$2.57**

SHURFRESH CHICKEN OR Ham Salad 8 OZ. CTN. **89¢**

SHURFRESH PIM./JALA. Cheese Spread 7 1/2 OZ. PKG. **89¢**

HEAVY GRAIN FED BEEF CENTER CUT 7-Bone Roast LB. **\$1.59**

HEAVY GRAIN FED BEEF LEAN Stew Cubes LB. **\$1.89**

HEAVY GRAIN FED BEEF Chuck Steak LB. **\$1.79**

Dairy And Frozen Food

SHURFINE SPEARS Broccoli 10 OZ. PKG. **39¢**

SHURFINE FROZEN Orange Juice 12 OZ. CAN **69¢**

SHURFRESH SM OR BM Biscuits 8 OZ. CANS **\$1**

SHURFRESH QUARTERS Margarine 2 16 OZ. PKGS. **89¢**

SHURFRESH HALFMOON Colby Cheese 10 OZ. PKG. **99¢**

SHURFRESH ASSORTED Ice Cream 1/2 GAL. SQ. CTN. **89¢**

SHURFINE FRUIT Cocktail 16 OZ. CAN **49¢**

SHURFINE LIGHT WATER/OIL PACK Chunk Tuna 6 1/2 OZ. CAN **69¢**

SHURFINE WHOLE PEELED Tomatoes 3 16 OZ. CANS **\$1**

Grocery Specials

SHURFINE EARLY HARVEST Sweet Peas 3 17 OZ. CANS **\$1**

SHURFINE YELLOW CLING Peaches SLICES/HALVES 16 OZ. CAN **49¢**

SHURFINE TOMATO Catsup 32 OZ. BTL. **79¢**

SHURFINE SM/CR Peanut Butter 18 OZ. JAR **89¢**

GOLDEN RIPE

Bananas

29¢ LB.

Produce Specials

CALIFORNIA SUNKIST Oranges 3 LBS. **\$1**

NEW CROP SWEET Onions YELLOW 2 LBS. **29¢**

CALIFORNIA GOLDEN Carrots LB. PKG. **25¢**

PURE VEGETABLE

Shurfine Shortening

48 OZ. CAN

\$1.69

FOR TEA LOVERS SHURFINE

Tea Bags

100 CT. BOX

\$1.49

venture FOODS

Houser Venture Grocery

902 Main Street Friona, Texas Ph. 247-3343

AFFILIATED

FAST USE THE WANT ADS FAST

PH. 247-2211

Reader Ads—First insertion, per word 10 cents
Additional insertions (no copy change), per word 8 cents

Minimum Charge \$1.50
Classified display (boxed ads—9 pt. type under a specific heading, 1 column width only—no art or cuts. Per column inch \$1.50

Cards of Thanks—same as classified word rate, 10 cents per word, minimum charge \$1.50

DEADLINE for classified advertising in Sunday's issue—Thursday noon.

Check advertisement and report any error immediately; The Star is not responsible for error after ad has already run once.

PRO AUCTION SERVICE

SPECIALIZING IN FARM AUCTIONS
For Any Type of Auction or Free Appraisal Call Us.

RT 2 BOX 96 Friona, Texas 79035
LARRY POTTS LELAND GUSTIN
PH 295-6633 PH 247-2146
Mobile Phone: 265-3645 Mobile Phone: 265-3648

M. D. Lovvorn
Dirt Moving

Tailwater Pits Land Leveling
Dams Farwell, Texas
Box 544
Phone (806) 481-9029

IN APPRECIATION

Thank you for your patronage in the past. It's been a pleasure being of service to you in your real estate needs.

I am now manager for Horn-Clayton Insurance Agency here in Friona. I will continue to be the Hi-Plains Savings and Loan Friona Representative.

Please come by or give me a call on any insurance needs or real estate loans at 723 Main.

Thank You
Carol Gatlin

ANNOUNCEMENTS

Friona Lodge No. 1332
7th & Ashland
Slated Meeting
1st Tues. 8 p.m.
J.L. Lane-W.M.
A.L. Outland-Sec.

NOW...In Friona. You can come direct to us and discuss a mortgage loan, or a home improvement loan. Let us visit with you on any financial question you might have.

Tri-County Savings and Loan
106 West Ninth Friona.
16-tfnc

THE BUTTERFLY INN
GIFT SHOP

Open Saturday, June 2,
10 a.m. till 5 p.m. 1604
James Street.
35-tfnc

RADIATORS
30 YEARS EXPERIENCE

KELLEY'S RADIATOR SHOP

CLEANING-REPAIRING-RECORDING-REBUILDING
NEW AND USED
ALL WORK GUARANTEED
T.A. KELLY-OWNER
EAST ON HIGHWAY 60 FRIONA, TEXAS 247-2292

A-1 ENGINE SERVICE

Chrysler, Industrial, & automotive engine & components, blocks, heads, crank shafts, pistons & valves.

PHONE: 806-364-6040, Hereford, Texas
P.O. Box 2066 79045

I have a large supply of NATURE'S SUNSHINE Herbs and Herbal Tea.

Also HILCOA natural vitamins and minerals and other food supplements. Call Irene Lotspeich, 247-3107 or come by 809 Columbia Avenue.
30-tfnc

LET FX BACTERIA
help clean your Septic Tank the Easy Way—\$6.98. Tree Roots Removed from Sewer Lines. Sinks opened.
Richard Perkins Plumbing
910 Columbia Street
Friona, Texas
32-4tc

**-NEW SHIPMENT-
-JUST ARRIVED-**
Gift stationery featuring pictorial sketch of Friona in 1910. \$3.00 per package.
Also "Hometown Note Paper" with scenes of Friona shops. \$2.00 per package.
Friona Star Office
916 Main

FARM EQUIPMENT

PLAINS EQUIPMENT COMPANY SPECIALS
New AC 7000 tractor \$18,000, 106 horsepower with cab and air conditioner
++++
Used 1974 Gleaner L combine, \$21,500, with new 20 ft. header, air conditioner.
++++
Used 1968 Gleaner combine, \$10,500, with 20 ft. header, gasoline.
++++
Come by and see these and more at:
5400 East Mabry Drive
Clovis
Or call James (505) 769-1938.
34-tfnc

LEGAL NOTICES

NOTICE TO BIDDERS
The Commissioners Court of Parmer County will accept bids until 11:00 a.m. June 11, 1979 for the purchase of one new motor grader for Precinct Number I, meeting the following specifications:
1-New Motor Grader equipped with 150 SAE net hp engine, power shift transmission, articulated frame, ROPS Cab, 14' chrome blade with a 2' extension, all hydraulic controls, 14.00x24 12-ply tires on 10" rims, self-adjusting wet disc brakes, scarifier, differential lock-unlock, minimum weight 31,000 lbs. Optional bids will be accepted on machine equipped as above with six-wheel drive.
Bids should be mailed to James P. Fortenberry, County Judge, Box 506, Farwell, Texas, 79325, or delivered to him in person at the Courthouse in Farwell, Texas prior to 11:00 a.m. June 11, 1979, at which time bids will be opened.
Parmer County Precinct Number 1 will offer in trade:
One used 99E Caterpillar motor grader which can be seen by contacting Ernest Anthony, Commissioner, Precinct Number 1.
The Commissioners Court of Parmer County reserves the right to accept or reject any or all bids.
BY ORDER OF THE COMMISSIONERS COURT OF PARAMER COUNTY:
James P. Fortenberry
County Judge
34-2tc

THE PRICE IS RIGHT on this 4 BR, 3 baths, fireplace, drapes, fenced yard and more.
ONLY \$55,000.00

NOTHING TO DO but enjoy this 2 BR, new carpet throughout, living room plus a large den.
ONLY \$19,500.00

SUCCESS LIVES HERE these 2 homes in Staley Addition offer gracious living which reflects a man's success. 3 BR, 2 baths, fireplace, built-ins, fenced back yard and many extras. Priced not for everyone.

I'm your Mary Kay Beauty Consultant. Call me for all your beauty needs. Earlene Jordan, call 247-2537.
47-tfnc

AUTOMOTIVE

We Are Now The Authorized Dealers in Friona For MICHELIN TIRES "The First Steel-Belted Tire"
WHITE'S AUTO

SERVICES

LADIES
For cleaner brighter carpet call for Steri Steam. Thomas Carpet Cleaning 238-1640.
30-tfnc

PETS

Dog Obedience Classes.....
Sponsored by Golden Spread Working Dog Club. Starting June 11, 1979, at Veterans Park, Hereford, Texas. 8 p.m., eight week course, \$20.00. In Friona call 247-3731 and ask for Don.
35-2tc

REAL ESTATE

MUST SELL....4 Bedroom home. 16x20 master bedroom with large walk-in cedar closet. 2 1/2 baths, large kitchen with built-ins. 20x20 playroom. 24x20 den with fireplace. Tornado shelter. 2 car garage. 100x200 ft. lot. Automatic sprinkler system. Cedar fence. See to appreciate. A steal at \$22.00 per square foot. Call for appointment. 247-2570 or 265-3881.
12-tfnc

FOR SALE....2 bedroom house on large corner lot, new carpet and kitchen tile, \$8,500.00. 604 East 9th. Call 247-2094.
32-tfnc

PROPERTY ASSOCIATES
REALTORS

102 East 11th Call 247-2745

OUTSIDE PAINTING.....
houses, barns, tanks, whatever.
Phone 247-3896.
30-tfnc

FOR SALE BY ESTATE....
1975 Lincoln Town Coupe. Less than 43,000 miles and-or 1973 Chevrolet Impala. Electric seats, electric windows, air conditioned. Less than 36,000 miles. Call 247-2778 or 247-3376.
34-tfnc

GARAGE SALES

GARAGE SALE....Friday and Saturday, June 8-9, 9 a.m.-6 p.m. 703 Arrah. Furniture, children and adult clothes, toys and misc. items.
35-tfnc

Saratoga Gardens Apartments
1300 N. Walnut
Friona
Call 247-3666

FOR RENT

FOR RENT....Unfurnished 2 bedroom apartment. Chateau Apartments. Call 247-2143.
17-tfnc

LOW RENT FOR NEEDY FAMILIES.... nice one, two and three bedroom apartments, pleasant surroundings, central air and heat, laundry facilities, 24 hour security.
Saratoga Gardens Apartments
1300 N. Walnut
Friona
Call 247-3666

FOR SALE

Two bedroom house. Carpeted. \$9,000
++++
Two bedroom House. Carpeted. \$11,000
++++
Rental property—Good buy at \$22,000.
++++
320 Acres, 3 Irrigation wells. First time offered at this price.
ED HICKS REAL ESTATE
Phone 247-3537 Or 247-3189 (home)

EARS PIERCED
Allen's Jewelry
Call 247-2830

FOR SALE....1972 Grand Ville Pontiac, white, loaded. Also 10 1/2 ft. Leisure Time Camper. Semi-self contained. Call 247-3021.
30-tfnc

FOR RENT

For Rent: Luxurious private office space. All utilities paid. Reasonable rates. Call Brown, Graham & Company Daytime—247-2743 or nights —247-3398 nad 247-3370.
18-tfnc

WANTED

Someone to car-pool for summer school at West Texas State University. Call 295-3898 at 12 noon or 9:30 p.m.
35-tfnc

NOTICE OF PUBLIC SALE

On Tuesday, June 5, 1979, at 11:00 a.m., at the Courthouse door of Parmer County, Texas, the following goods will be sold for cash at public auction, to-wit:
2 Circular Sprinklers described as follows:
1-1977 Valley Electric 7 tower sprinkler system and panel with corner machine attached, Ser. No. 22815
1-1970 Gifford Hill Electric 360-10 tower sprinkler system, Ser. No. 72297031970
4 Irrigation Motors described as follows:
1-8 cy. Olds, Serial No. 412753
1-8 cy. Olds, Serial No. 380145
1-6 cy. Ford, Serial No. D5TE-6015-AA
1-800 H.D. M-M, Serial No. 34901384
2 Gearheads situated on Irrigation Pumps:
1-Amarillo, Serial No. 3BC44803
1-Green, Serial No. 22G8546
2 Byron-Jackson Pumps, described as follows:
1-10" Serial No. None
1-8" Serial No. None
The above goods may be inspected at their present location, which is upon the South Half (S/2) of Section Eight (8), Block H, Thomas Kelly Subdivision, Parmer County, Texas, by previous arrangements with J.R.

THANK YOU

After 25 years, now comes the time to say "Thank You", for sharing with me your most prized possession, your children. I have enjoyed each one and watched them grow into lovely people. Again I say thank you.

PEARL McLEAN

ELECTROLUX
Vacuum Cleaners
Sales & Service. Phone 247-3156. Mrs. L.R. White, 806 Ashland Ave.
38-tfnc

FOR SALE....1973 Olds- mobile. In good condition. Fully equipped. Call 247-3538 after 4 p.m. or anytime on weekends.
29-tfnc

WANTED

Someone to car-pool for summer school at West Texas State University. Call 295-3898 at 12 noon or 9:30 p.m.
35-tfnc

FOR SALE....4 bedroom brick home. 6 ft. fence, storage building, gas grill, 1 1/2 baths, central heat and air. 1501 Columbia. For appointment call 247-3765.
26-tfnc

FOR SALE BY OWNER....3 bedroom home in Bovina. Large, one bath, corner lot. One block from school. Quiet neighborhood. Call days—276-5286 or evenings—364-0113.
30-tfnc

DON'T BUCK
the
ELEMENTS

buy
CROP HAIL INSURANCE
with
FIRE COVERAGE
featuring
annual or term
standard or deductible
(if available)
C.L. LILLARD
PHONE 247-3320 DAY or NIGHT

MONEY TO LEND
Re-Financing
Farm.....Commercial
Residential
Call or See
(Day or Night)
STEVE H. BAVOUCETT

Phone 247-3880
Friona, Texas

Your **RADIO SHACK** Dealer in Friona is White's Auto We have CB Radios
19-tfnc

JOBS WANTED

BABYSITTING IN MY HOME..... Children 3 years and older. Call 247-2133. 1005 Prospect.
35-2tc

JOB WANTED
Teenage girl available for babysitting jobs, 8 a.m.-5 p.m. Call 247-2592.
35-2tc

Stephens Realty
Complete Real Estate Service
Farms, Ranches, Homes, Rental Service, Property Management, 806 Austin, Phone 247-3338.
10-tfnc

KIRBY SALES & SERVICE
CARL WHITE
Phone 247-3618
Or 247-3271

NOW IN FRIONA
WATKINS PRODUCTS
A tradition of quality since 1868. Featuring our famous +Vanilla +Pepper +Liniment +Extracts +Kitchen Spices
For free delivery and a complete list of products, call Terri Welch 404 Ash Friona, Texas 247-2096 24-tfnc

FOR SALE....Sears Best 10-speed bicycle. Like new. Call 295-6863.
33-tfnc

FOR SALE..... Williams Craft camper and fiberglass camper. (806) 285-3309.
33-3tc

FOR SALE....Green electric stove \$75.00. Solid oak couch and matching chair, \$140.00. Call 247-3802.
35-tfnc

B & B AUCTION SERVICE

★FREE APPRAISALS
★GUARANTEE ALL CHECKS

For Any Kind of AUCTION or APPRAISAL Call Us
License #TXCG-019-0504

HOUSTON BARTLETT, Auctioneer BIG NICK TREINEN
Phone: (806) 225-6699 Phone: (806) 23871614
Bovina, Texas Bovina, Texas

ADAMS DRILLING CO., INC.

WATER WELL DRILLING

PEERLESS PUMPS PUMP & GEAR
SALES & SERVICE HEAD REPAIRS
ALL MAKES

CALL 247-2731 FRIONA, TEXAS

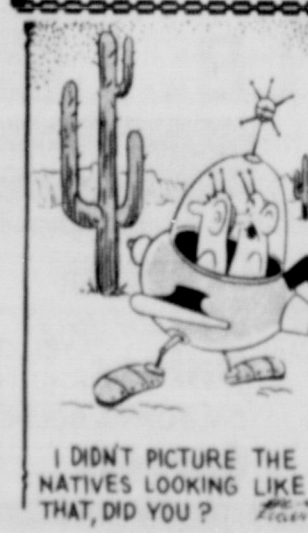

LAURA ELLIS

Friona Girl Named To "TEXAS" Cast

A Friona girl has been chosen for the cast of the "TEXAS" production, currently rehearsing for its 14th season in Palo Duro Canyon. Two other Parmer County residents are members of the staff's "hospitality" crew.

Laura Ellis, recent graduate of Friona High School, is a member of the "on stage" company, and will be a dancer in the 1979 production. Laura, the daughter of Mr. and Mrs. Bill Ellis, is the second FHS graduate to appear in the production. Carl Evans was the other.

Richard Rejino and Craig Skaggs, both of Bovina, are members of the hospitality crew, and are getting ready to set up the theatre and concession area and will greet the guests at the production.

Other area residents who will be in the 1979 production include Patty Hendon of Hereford and Sharon Lindeman of Umbarger, the reigning "Miss WTSU," who will play "Miss Elsie" in one of the lead parts in the current show.

A number of the young artists are from Amarillo and Canyon. Actors selected for 1979 are also from Plainview, Lovington, N.M., Hamilton, Wichita Falls, Weatherford, Okla., Lawton, Okla., Hobbs, N.M., Artesia, N.M., Lafayette, La., New Braunfels, Austin, Houston, Guymon, Okla., Dallas, El Paso, Ft. Worth, Booker, Odessa and Bogalusa, La.

Other cities represented are San Antonio, Lubbock, Edinburg, Tulia, Freeport, Garland, Midland, Colleyville, Dalhart, Burkburnett and Lockney. Cast members were chosen following tryouts held at six cities across the state of Texas.

The actors, dancers and singers have been rehearsing for eight hours a day since May 21, preparing for the

June 20 opening. Rehearsals so far have been at the Branding Iron Theatre at WTSU, but soon will move to the theatre in Palo Duro Canyon.

They'll be easier this year because the three year building program in the theatre is almost finished. Workmen are putting the last touches on the addition to the men's dressing room which will double the space the men have had. New showers are in to the delight of those who play the role of Indians. The costume shop is enlarged, and a small electrical building house equipment to increase the power coming to the theatre and facilitate its use, is finished.

The audience will notice a difference too, since the men's rest rooms have been enlarged.

These improvements complete the three year building program which the Texas Panhandle Heritage Foundation undertook in 1977. It has included permanent installation to two rows of seats in the rear, a new exit from the theatre, new side stage buildings and new sets for their use, a new entrance into the parking lot, a cast building back stage, in addition to the work just being finished.

The total cost has been \$182,897. The work this year was a state project and the bid was \$46,650. The rest of the construction was financed through special gifts to the Texas Panhandle Heritage Foundation--including the idea for and gift of the entrance by the A.A. Bushes of Amarillo, and through funds from the "TEXAS" ticket sales.

The audience will be able to see the difference in the facilities when "TEXAS" has the Gala Opening on June 20, 1979. As usual the show will open at 8:30 p.m. The barbecue service will start at 6:30, and the season will run through August 25,



LAURA ELLIS

nightly except Sundays. The extra Fourth of July show will be on July 1.

Although it is well to make reservations in advance, no one has had to be sent home without them except on occasional Saturdays. There have been no gas shortages in the Panhandle. For tickets and information write Box 268, Canyon, Texas 79015 or call 806-655-2181.



We have a new resident, Berta Culp from Hereford, originally from Tennessee. She has been with her son, Nealy Culp in Hereford. We are so pleased to have her.

Mrs. Nellie Oldham is in the Parmer County Community Hospital. Paul Griffith is in the Veterans Hospital in Amarillo.

Claude Osborn went for a drive in the country and a tour of the crops this week. This is the first time Claude has been out since he became ill in January. His brother, Jess, from Austin was here for a visit this week.

The Sixth Street Church of Christ had our monthly birthday party this week. Those honored were Clara Smith, Bessie Ziemann and Malinda Schlenker.

Sam Vaughn's birthday is the only birthday coming up in June. Sam's birthday is June 20.



GO CLASSIFIED FOR THE ACTION YOU WANT

LOOKING GOOD!



THE BARGAIN IN CATTLE FEED TODAY

Hybrid vigor, sweet and succulent, with lots of leaves... excellent for baling, stacking, green chop, grazing, or late planted for standing hay. Sweet Bee is rapid growing and more disease resistant than most of the old time forages. Sweet Bee is adapted for irrigation or dryland and may be planted late and still make excellent feed for livestock.

Friona Wheat Growers & Jayson Grimsley

GEORGE WARNER SEED COMPANY • 129 S. LAWTON P.O. BOX 1448 • HEREFORD, TEXAS 79045

We Have Savings! YOU Buy for Less!

White Swan Macaroni & Cheese

Dinners 3/79^c
7 1/4 Oz. Box

Jell-O 2/53^c
Asst. Flavors 3 Oz. Box

White Swan Pure Vegetable Shortening \$1.99
3 Lb. Can

Diamond Paper Plates
With Super Six Card **1.12**
Without Super Six Card **1.69**

Club Steaks \$2.90
Pound

Booth Fantail Breaded Shrimp \$3.19
10 Oz. Box

Wilson Bacon \$1.49
Pound



Double Stamps On Wednesday



White Swan Salad Dressing
Qt. Jar

With Super Six Card **35¢**
Without Super Six Card **95¢**

Frozen Foods
Magic Garden Strawberries 10 Oz. Box **39¢**

Ore Ida Onion Rings 7 Oz. Box **43¢**

White Swan Napkins 250 Ct.
With Super Six Card **61¢**
Without Super Six Card **1.19**

Tomatoes 47¢
Pound

Russet Potatoes 95¢
10 Lb. Bag

Cucumbers 39¢
Pound

WHITE'S SUPERMARKET

OUR AIM IS TO PLEASE IN EVERY WAY

WE ACCEPT USDA FOOD STAMPS PHONE 247-2250



PRESENTS CHECK... Gay Tannahill presents Merv Noah, of Prairie Acres, a check from the Progressive Study Club. The check

was a contribution for the new Bennett Breathing Machine, also pictured.

Attention Farmers: We Have These Varieties Of Soybean Seed Available For Planting During The Month Of June:

Certified Clark 63
Non Certified



Columbus, Mitchell and Multi-Var 91.

Kelly Green Seeds, Inc.

Box 366 Farwell, Texas Phone: 481-3810

Unbeaten List Drops In Softball

The list of unbeaten teams in Friona's summer softball league was trimmed to two after games of Tuesday, May 29.

The only teams sporting unbeaten marks are the Scottsmen in the men's division, with a 7-0 record, and the Chics in the women's league, at 4-0.

MBPXL socked Sonic Drive In, 16-

Team	W-L
Scottsmen	7-0
Sonic Drive In	6-1
MBPXL	7-3
Adams Drilling	4-2
Cunningham Electric	4-5
Friona Wheat Growers	3-4
Black Grain	3-5
Northside 66	3-5
Dairy Queen	2-5
Parmer County Implement	1-7

8, to hand the Sonics their first loss of the year in the men's division.

The Chics continued their unbeaten streak by beating Ethridge-Spring, 19-3 in the women's division.

Team	W-L
Sonic Drive In	19
Cunningham Elec.	13
Black Grain	10
MBPXL	14
Cunningham Elec.	2
MBPXL	32
Parmer Co. Imp.	5
MBPXL	17
Friona Wheat Gro.	12
Parmer Co. Imp.	13
Northside 66	12
MBPXL	16
Sonic	8
Northside 66	20
Dairy Queen	12
Black Grain	20
MBPXL	11
Black Grain	20
Northside 66	13
Scottsmen	30
Parmer Co. Imp.	10
Adams Drilling	17
Dairy Queen	7

In the home run derby, S.D. Baize socked a pair, to tie David Hutson for the league lead. Hutson hit one homer during the week. Both players had eight home runs as of March 31.

Team	W-L
Chics	4-0
Cook Oil	3-1
Ethridge-Spring	1-2
Herring Implement	1-3
Friona Industries	0-3



LEAGUE CHAMPS....Betty Rector, right, presents the sponsor's trophy to David Goddard of Friona Industries. The Friona team won the

championship of the Morning Star League in Hereford, and in addition, Mrs. Rector had the league's high average. Other team members shown

are Sheri Martin, left, and Sharon Rector. Not present was team member Betty Smith.

Friona Team Shines; Nips Clovis, 3-2

The Friona Six Packs ran their season record to 4-2 for the season, with an impressive 3-2 win over the Clovis Sonics in a game here last Sunday.

The Clovis team is managed by Frank Castillo, formerly of Friona, and former manager of the Six Packs.

Pedro Gomez singled with two out in the bottom of the ninth inning to drive in Andy Mata with the winning run in the pitcher's duel. Lefthander Arturo Gomez held Clovis to only five hits, while Friona managed just six.

Friona used the base-running of Johnny Diaz to score a pair of runs. In the first inning, Diaz walked, stole second and third, and came home

when the Clovis catcher missed the ball.

After Clovis took a 2-1 lead, Friona tied it in the sixth, when Diaz again walked and stole second base. Arturo Gomez, the pitcher, singled to score Diaz with the tying run.

In the ninth, Andy Mata walked to lead off the inning for Friona. David Davila sacrificed him to second. After Tony Rios struck out, Pedro

Gomez singled to score Mata with the run to end the game.

Arturo Gomez struck out 17 Clovis batters. An excellent crowd was on hand to watch the game.

Friona will travel to Hereford to meet the Hereford Rebels this Sunday.

Star Needs

L.L. Reports

Note to Little League officials: The Friona Star needs your information turned in on Wednesday of each week so we can provide write-ups of your games.

Please assist us in seeing that these games are reported each week.

Clovis	002	000	000-2
Friona	100	001	001-3
Johnny Diaz	lf	2-2-0;	Ray Rangel,
2b	4-0-1	Joe Mata,	3b, 4-0-0;
Arturo Gomez,	p,	4-0-1;	Mario
Castillo,	c	4-0-1;	Andy Mata,
cg	3-0-1;	David Davila,	rf, 3-0-0;
Tony Rios,	ss	4-0-0;	Pedro Gomez,
1b,	4-0-2.		

Just A Reminder-----

We Are Ready To Serve Your Custom Slaughter Needs. Save Some Money ----- Let Us Kill Your Beef ----- Also See Us For Halves Of Beef, Quarters, Etc.

WINKLER MEAT CO.

401 MAIN MULESHOE 272-4703

THANK YOU, FRIONA

For Your Support During The Past Year--The First Year Under The Present Ownership.

We Pledge Our Best Efforts To Serve You Better During The Coming Year.

Roger Wilcox, John Baxter & V.R. Wilcox

We Now Have Special Values On Our Just Traded For Used Cars. Come On By!

FRIONA FORD SALES, INC.

1011 Grand — Friona, Texas

PHONE 247-2701 or 238-1395

"Parmer County's Only Authorized Ford Dealer"

SPECIALS GOOD WHILE SUPPLY LASTS! LIMITED SUPPLY!!

ALLSUP'S CONVENIENCE STORES

PRICES EFFECTIVE MAY 31 - JUNE 6, 1979

WE RESERVE THE RIGHT TO LIMIT!

SUMMER REUNION SALE

<p>ASSORTED REGULAR OR DIET SHURFINE POP 7 \$1.00 12 OZ. CANS</p>	<p>SHURFINE MACARONI AND CHEESE DINNERS 4 \$1.00 7 1/4 OZ. BOXES</p>	<p>SHURFINE CS OR WK GOLDEN CORN 3 \$1.00 17 OZ. CANS</p>
<p>FRIJO-LAY ASSORTED DORITOS REG. 8 1/2 OZ. BAG 69¢</p>	<p>BORDEN'S FUDGE OR FROSTY POPS 24 PK. \$1.29</p>	<p>SHURFINE BM. SM BISCUITS 8 OZ. CANS \$1.00</p>
<p>FOLGER'S ALL GRINDS COFFEE 1 LB. CAN \$2.39</p>	<p>ALLSUP'S ICE CREAM 1/2 GAL. RD. CTN. \$1.29</p>	<p>SHURFINE MARSHMALLOW PEANUTS 7 1/2 OZ. BAGS 89¢</p>
<p>BORDEN'S SOUR CREAM 8 OZ. CTNS. 89¢</p>	<p>SHURFINE QUARTERS MARGARINE 2 16 OZ. CTNS. 89¢</p>	<p>SHURFINE SALTINE CRACKERS 2 16 OZ. BOYS \$1.00</p>
<p>SHURFINE 2 PLY BATHROOM TISSUE 8 ROLL PKG. \$1.39</p>	<p>SHURFINE BEEF FRANKS OR BOLOGNA 12 OZ. PKG. \$1.09</p>	<p>SHURFINE HALFMOON CHEDDAR OR LONGHORN COLBY CHEESE 10 OZ. PKG. 99¢</p>
<p>SHURFINE MUSTARD 2 16 OZ. JARS 69¢</p>	<p>SHURFINE LIGHT CHUNK TUNA 6 1/2 OZ. CAN 69¢</p>	<p>ENERGY CHARCOAL LIGHTER 32 OZ. CAN 69¢</p>
<p>SHURFINE CATSUP 32 OZ. BTL. 79¢</p>	<p>SHURFINE CUT GREEN BEANS 3 16 OZ. CANS 89¢</p>	<p>ENERGY CHARCOAL BRIQUETS 10 LB. BAG 99¢</p>
<p>SHURFINE WHOLE SWEET PICKLES 22 OZ. JAR 89¢</p>	<p>SHURFINE FLOUR 5 LB. BAG 59¢</p>	<p>SHURFINE 1 PLY ASSO. NAPKINS 60 CT. PKG. 19¢</p>



DONNA JEAN CAMPBELL and DAVID BRUCE HARPER...Mr. and Mrs. Ray Campbell of Friona announce the engagement and approaching marriage of their daughter, Donna Jean, to David Bruce Harper of Amarillo, son of Mr. and Mrs. William E. Harper of Alamogordo, New Mexico. Wedding vows will be exchanged on Saturday,

June 23 at 7:30 p.m. at the First Baptist Church in Friona. Miss Campbell is a 1978 graduate of Friona High School and attended West Texas State University. Harper is a graduate of Alamogordo High School and is employed at Fab Steel in Amarillo where the couple will make their home.



TONI OAKLEY and RICK JOHNSON...Mr. and Mrs. Charles Oakley of Stratford are announcing the engagement and approaching marriage of their daughter, Toni, to Rick Johnson of Friona. The couple plan to exchange wedding vows at Hill Chapel on the WTSU campus, Canyon, on July 28. Parents of the prospective bridegroom are Truett Johnson of Lubbock and the late

Thelma Johnson. The bride-elect is a student at West Texas State University majoring in speech and hearing pathology and is a member of Delta Zeta Sorority. Johnson is a 1978 WTSU graduate with an agribusiness economics degree and is a member of Lambda Chi Alpha Fraternity. He is employed with Holl Tex in Amarillo. The couple plan to make their home in Canyon.

Town Talk

By June Floyd

Phone 247-3681 With Your News Item



Thanks to the fishing ability, luck or whatever you choose to call a good catch, of Eugene Boggess, the Floyds had fish for lunch Saturday. This was a special treat since we had spent several days last week fishing at Lake Hubbard and didn't even see a fish.

Where, except in Friona, would one expect to come home from a fishing trip with no fish and have friends supply fish for lunch the very next day?

The Kansas branch of our family, Gerald, Jana, Jason and Sarah, ate lunch with us that day.

Oscar and Opal Baxter are home. They spent two weeks camping and fishing at Lake Foss, which is in the vicinity of Clinton, Oklahoma. Opal's sister and brother-in-law, Jewel and Curt Segrist, who live in Elk City, vacationed with the Baxters. They report a good catch.

One day the group attended a Flea Market in Foss and ran into Mickey and Kenneth Williams and Jerry and Belle Maynard, who live in Cordell, Oklahoma now.

All of them are former Friona residents.

One of Opal's aunts, Mrs. Ila Libby of Elk City died last week and the Baxters and Segrists attended funeral services for her Saturday.

Long time friends of the two couples, Mr. and Mrs. Orville Boggess of Cheyenne, Oklahoma, spent some time at the lake, too.

Rudolph Renner, Sr. has been "under the weather" for several days and has been staying in most of the time. This is real unusual for this hardy pioneer, who is always up and about doing something.

The Renners recently attended high school graduation ceremonies at Jal, New Mexico. Their youngest grandson, Darcy Renner, was a member of the graduating class.

Darcy, the youngest son of Cotton and Kay Kirk Renner, started to school here with a lot of the members of Friona's 1979 graduating class.

Others attending from here were Billy Dean and Lilly Mae Baxter and Doyce and Mary Joyce Barnett. Ted

and Pat Renner and little daughter, Annie, drove over from Andrews for the exercises and to visit with the rest of the family.

Christy Cunningham, who was also a member of the 1979 graduating class from the first grade through the sophomore year, recently graduated from Andrews High School.

Christy is the youngest daughter of Walter and Betty Cunningham and her grandmothers, Susie Cunningham and Lavernia Duke, both live here.

Funeral services for a former Friona resident, Brit Dozier of Levelland, were conducted there Wednesday afternoon, Brit, the 12 year old son of Calvin and Linda Dozier drowned while on a fishing trip in Central Texas for the Memorial Day Weekend.

Brit was born here. The Doziers and their two children, Lynita and Brit moved from here to Levelland about eight or nine years ago.

Frionans attending the services were Mr. and Mrs. Calvin Martin, Mr. and Mrs. Leland Hutson, Mr. and Mrs. Oscar Baxter, Mr. and Mrs. Clarence Martin, Mr. and Mrs. John Baxter and Larry Martin.

Mr. and Mrs. Troy Young of Hobbs, New Mexico and Mrs. Boyd Pipes and children of Bovina also attended.

Frionans who enjoy local talent and ball games have had a treat this summer. You can drive to a ballpark just about any evening and see a good game. We have little leaguers, men's slow pitch teams and women's slow pitch teams, so you can just about take your pick of games you want to see.

Think most of the adult games begin at 10 p.m., after the younger people have finished, so you can see more than one game if you desire.

We drove down to watch the Cook Oil women's team play the Friona Chicks Wednesday evening. Early in the game Melba Smiley, in a brave effort to make third base, had an accident.

Julie Owen Earns WTSU Scholarship

West Texas State University's President's Honor Scholarships have been awarded to 325 graduating high school seniors from 113 Texas, New Mexico and Oklahoma towns and cities as of May 17.

Now in its second year, the scholarship program has already attracted over one third more participants than last year's total count, and the number grows each week.

The final number of high school honor society members who accepted the \$100 scholarships to attend West

Texas State for the 1978-79 academic year was 213.

Julie Owen is the President's Honor Scholar from Friona. She is the daughter of Robert E. Owen of Friona.

Not only has the WTSU President's Honor Scholars program gained in popularity among the tri-state area's scholastically talented high school seniors, students and faculty members on the WTSU campus have begun donating money to augment the scholarship fund.

Phi Delta Theta social fraternity was the first student organization to offer support.

She was taken by local ambulance to Parmer County Community Hospital and then following emergency treatment was taken to an Amarillo hospital, where she had bone surgery on an ankle Thursday morning.

Dewayne and Cheryl Procter and children, Darren, Wade and Darla Sue of Shallowater were weekend visitors in the home of James and Sue Procter.

Then, the children stayed for a few days.

Frionans are going to miss Gale and Linda Warren and son, David, who have moved to Abilene. Frankie and Oneida Allen have bought the Warren's home on West Sixth and are moving in.

Hap and Julia Fairchild and Otis and Athela Neel were in Adrian Tuesday evening for high school graduation. Their granddaughter, Tammy Kay Fairchild, was a member of the graduating class.

Tammy is another student who started to school here with the 1979 class and the moved away with her parents, Larry and Paula, brother, Jeff and sister, Vicky.

The Adrian seniors left the day following graduation for a ten day vacation in Hawaii. This group began working, planning and saving money

for their senior trip when they were freshmen and had made all arrangements ahead of time.

Chloe Ann Ford Webb and two and one-half year old daughter, Sheila, have been visiting in the Friona area this week. The Webbs have lived in Wichita, Kansas for the past four years and are former Friona residents.

They have been visiting with her brother and family, Kenny and Mary Ford and their daughters, Lee Ann and Stephanie. Also visited in Hereford with her father Howard Ford. This was Sheila's first visit to Texas.

**The clock of life is wound but once
And no man has the power
To tell just when the hands will stop
At late or early hour.**

**Now is the only time you own!
Live, love, toil with a will;
Place no faith in tomorrow,
For the hands may then be still.**

**The tender words unspoken,
The letter you never sent,
The long forgotten messages,
The wealth of love unspent----**

**For these some hearts are breaking,
For these some loved ones wait;
So show them that you care for them,
Before it is too late.**

Have you heard?

**ANNOUNCING
NEW SHARE
CERTIFICATES**

COMPARE OUR YIELDS

7.25%	7.50%	7.75%
Paid on Six Month Certificates \$1,000 Min.	Paid on Six Month Certificates \$5,000 Min.	Paid on Six Month Certificates \$10,000 Min.
A Substantial Penalty If Withdrawn Early		

Federal Regulations prohibit payment of dividends in excess of available earnings.

**FRIONA TEXAS
FEDERAL CREDIT UNION**
6th & Euclid Ph. 247-2736

**ENROLL FOR
SWIMMING LESSONS**
June 2, 1979 9:00-12:00

Friona Swimming Pool
Classes Will Be Held June 4- 22
Monday - Friday.
15 Lessons
Classes For Beginners,
Advanced Beginners and
Intermediates.

Three Experienced Instructors
Instructor: Phillip Duggins
Assistants:
Karen Edelson &
Sharla Duggins

LOOKING GOOD!



SUCROSSE
SORGO SUDANGRASS HYBRID

**RESEARCHED
FOR
TOP
PERFORMANCE**

SUCROSSE is a sweet sorgo-sudangrass hybrid bred especially for a grazing, green-chop or hay crop. Sucrosse is a brand name and is used only for varieties where one or both parents are sweet stalked and have the natural plant sugar referred to as sucrose.

**Friona Wheat Growers &
Jayson Grimsley**

GEORGE WARNER SEED COMPANY • 120 S. LAWTON
P.O. BOX 1446 • HEREFORD, TEXAS 76045

**You Are Invited
To Attend
"The Golden Years
Of Country Music"**

**Thursday, June 7
8:30 P.M.**

High School Football Field
If Bad Weather: High School Auditorium
Muleshoe, Texas

Featuring: Randy Ellis



Friona Native, as As The
"Singing Brakeman"
Sponsored By The Muleshoe
Fine Arts Boosters

Muleshoe To Host Country Music Show

"The Golden Years of Country Music" is coming to Muleshoe, for a performance June 7, to benefit the Muleshoe Fine Arts Boosters, who plan to use the proceeds to buy junior high band uniforms.

The country music road show, a production of South Plains College, Levelland, will be performed at 8:30 p.m. on the High School Football Field.

"Golden Years" features about 40 songs spanning 50 years of country music history. Included in the cast of singers is Randy Ellis, Friona native. Randy is the son of Mr. and Mrs. Eugene Ellis of Route 1, Friona.

Songs include "Will There Be Any Freight Trains In Heaven" by Jimmie

Shower Fetes

Local Bride

M'Lynnda London was honored with a lingerie shower Tuesday, May 22 in the home of Mrs. Billy Scott.

Table appointments were of crystal and the bride's chosen colors of purple and orchid were carried out in the centerpiece and refreshments. A hostess gift of lingerie was presented to the honoree.

There were twenty-six guests and special guests were Mrs. Jerry London and Mrs. Florian Jarecki, mothers of the couple.

Jennie Scott was the hostess. Miss London and John Jarecki plan to exchange vows June 14.

Bond Sales Released

March sales of Series E&H United States Savings Bonds in Parmer County were reported today by County Bond Chairman Charles E. Allen to be \$20,078. Sales for the three month period totaled \$30,897 for 36 percent of the 1979 sales goal of \$85,000.

Texas sales during the month amounted to \$22,972,794, while sales for the first three months of 1979 totaled \$68,903,444.

Rodgers, known as the father of modern country music; "Mule Skinner Blues" by Bill Monroe, father of bluegrass; "Wabash Cannon Ball," "Smoke, Smoke, Smoke," "Your Cheatin Heart," "Folsom Prison Blues" and "Amanda," among many others.

Country and bluegrass artists represented in the show include Hank Williams, Elvis Presley, Johnny Cash, Flatt and Scruggs, Waylon Jennings, Dolly Parton and many others.

The music in "Golden Years" should sound pretty much like the original recordings, if John Hartin and crew have anything to say about it.

"We worked primarily from original recordings arranging all the songs and cast members listened to tapes of the originals," said Hartin, vocalist and electric guitarist in the show. Hartin also is director of a two-year program in country and bluegrass music at SPC. "We are trying to come as close as we can to the original sound."

"We think every artist we recognize in the show has made a definite impact on the business," said Hartin, who also has been a professional guitarist for a number of years.

"Golden Years," along with the music has a story to tell.

"There's a story developing in the fact that country music has left the hills and is being recognized in metropolitan areas," said Hartin.

"Certain things were happening in

Kentucky with the bluegrass in the 30's and 40's; at the same time a completely different type of country music was followed in Texas by the Carter Family, who did a lot of recording and broadcasting down at Del Rio. They had a big 50,000 watt station that was heard all over the country," he added.

The show goes on to recognize people who stuck with country music at a difficult time.

"People who really deserve some recognition for their contributions are artists who stayed with country music in the 40's and 50's," said Hartin, "especially in the mid-50's when Presley and Ricky Vinson and these guys were getting popular. The country music thing, record sales just almost died. And guys like Ernest Tubb, Hank Snow and Roy Acuff kept the Grand Ole Opry movement alive...They were doing shows in schoolhouses, kind of keeping the interest alive," he said.

In the 60's, musicians like Johnny Cash and Merle Haggard made their play for fame. "They all had a completely unique style and were tremendously successful," said Hartin.

Willie Nelson and Waylon Jennings symbolize the outlaw movement, moving away from Nashville and bringing the music back to where it started, in Texas," he noted.

Golden Years will feature faculty and students from SPC's country and bluegrass music program and students from the speech and drama



MR. and MRS. H.D. (BILL) BRADSHAW...A reception will honor Mr. and Mrs. H.D. (Bill) Bradshaw on the occasion of their 50th wedding anniversary Sunday, June 10. The reception will be held from 3 to 5 p.m. in the Fellowship Hall of the

First Baptist Church, Bovina. The children and grandchildren of the couple will host the occasion. Mr. Bradshaw and Erma Lee Hulsey were married June 9, 1929 in Matador, Texas. The couple requests no gifts please.



SINGING BRAKEMAN RETURNS...Randy Ellis of Friona will do a song made famous by Jimmie Rodgers, known as the "Singing Brakeman" and father of modern country music during "The Golden Years of Country Music," a two hour show coming June 7 to Muleshoe. Showtime is 8:30 p.m. at the High School Football Field. In event of bad weather, "Golden Years" will be performed in the High School Auditorium. Ellis, guitarist and vocalist, will perform "T.B. Blues" and several other hits.

department as well. Featured instruments will include fiddles, acoustic, electric and pedal steel guitars, mandolin, banjo, auto harp, piano and drums. In event of bad weather the show will be at the high school auditorium.

Hospital Report

ADMISSIONS--

Octavio Martinez, Friona; Estella Rêyes, Hereford; Annie Scott, Friona; Dorothy Kainer and baby boy, Hereford; Virginia Mendoza, Friona; Debra Hume, Friona; Opal Spring, Friona; Oralia Escalante, Friona; Ava Woodson, Farwell; and Nellie Oldham, Friona.

DISMISSALS--

Royce Hume, Mario Espinoza, Jr., Corinne Jones, A.C. Nittler, Octavio

Martinez, Sue Atchley and baby boy, Tonya Vallejo, Estella Reyes, Annie Scott, Virginia Mendoza, Linda Drake and baby boy, Dorothy Kainer and baby boy and Debra Hume.

PATIENTS IN HOSPITAL--

Opal Spring, Oralia Escalante, Nellie Oldham, Sue Kent, Martha Castillo, Mac Fields, Esmeralda Lopez and baby boy.

Happy Birthday Friona Folks

WEEK OF JUNE 2-8
Friona residents having birthdays next week are:

Jason Hesse, June 2
Libby McErvooy, June 2

Cara Brockman, June 3
Kiley D. Gibson, June 3

Stormy Hartwell, June 4

Gene Weatherly, June 4
Ida C. Hadley, June 4
Ruth Tucker, June 4
Cap Dennis, June 4

Clarence Ashcraft, June 5

Chris Mabry, June 6
Lynn Widmier, June 6
Sylvia Gibson, June 6

Joe Bob Mann, June 8
Kevin Zachary, June 8
Deanna Poarch, June 8
Rachael Knowles, June 8

If you or someone in your family has a birthday coming up soon, call the Friona Star at 247-2211 by Thursday noon and report it.

M. Terrys Have Boy

Mr. and Mrs. Mitch Terry of Friona are the parents of a baby boy born Tuesday, May 22 at 4:25 p.m. in Deaf Smith General Hospital, Hereford.

Named Scott Michael, the new arrival weighed six pounds, three ounces and was nineteen and one-half inches long at birth.

Scott is the first child for the couple.

Grandparents are Mr. and Mrs. Raymond Schueler and Mr. and Mrs. John Terry, all of Friona.

Great-grandparents are Mrs. Robert Schueler and Vivian Hughes, also of Friona.

Birthday Celebrated

Malinda Schlenker of Prairie Acres celebrated her 91st birthday Friday, May 18.

The celebration was held at her home in the Rhea Community with family members enjoying a picnic lunch in the back yard. The birthday cake for Mrs. Schlenker was made by Judy

Schlenker. Family members attending included Mr. and Mrs. Carl Schlenker, Mr. and Mrs. Floyd Schlenker, John and Lori, Mr. and Mrs. Bob Johnson, Mendi and Abby, Mrs. Carleen Sims and Marcie of Lubbock, Mrs. Sarah Dean and Mrs. Gladys Spring of Bovina.

Share a smile with someone special



A professional 8 x 10 color portrait for

Choose from our selection of 8 scenic and color backgrounds. You may select additional portraits offered at reasonable prices, with no obligation. See our large Decorator Portrait. Satisfaction always, or your money cheerfully refunded.

88¢

Thursday, Friday & Saturday June 7, 8 & 9 10 a.m. - 8 p.m.

W. 11th St. Friona, Texas



One sitting per subject—\$1 per subject for additional subjects, groups, or individuals in the same family. Persons under 18 must be accompanied by parent or guardian.

Customer averaged billing plan

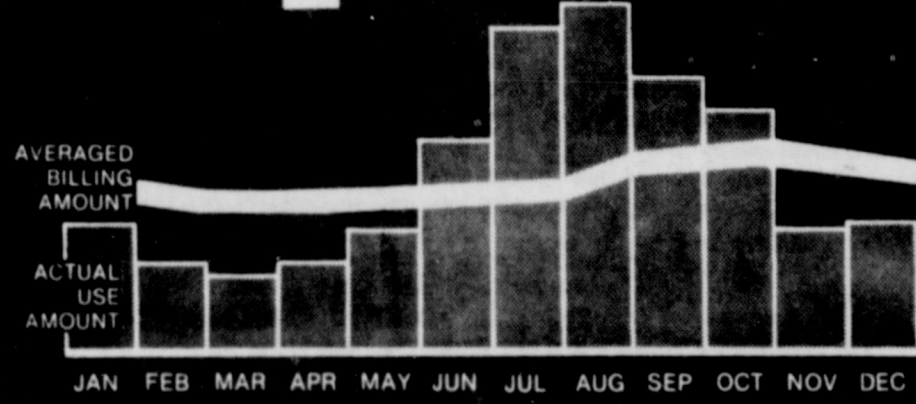

Southwestern's Averaged Billing Plan is designed to minimize the ups and downs in your electric bill.

If you've wished the amount of your electric bills could be more consistent every month instead of changing so much between seasons — here's a way

The Averaged Billing Plan is provided to HELP SMOOTH OUT THE HIGHS AND LOWS that occur in your electric bills. As the name implies, this plan arranges for you to pay an "average" rather than the actual amount used each month.

Who's eligible for this plan?

Any residential customer with satisfactory credit, whose average bill is \$25.00 or more, can request the Averaged Billing Plan.

How to get started.

All you have to do is call

Southwestern Public Service Company. There's no charge for participation in the Averaged Billing Plan. If for any reason you decide to drop the plan once you've started, just notify us. Payment by Automatic Bank Draft can also, in most cases, be arranged.

This is how the Averaged Billing Plan works.

The dollar amount of your electric bill each month will be determined by averaging the actual dollar amount of your bill for the past 12 months. When the amount you have paid does not cover the amount you have used, 15 percent of the difference will be added to your monthly average.

So, the Averaged Billing Plan does not change your rate, but allows you to pay less during high-use months and make up the difference by paying more during low-use months.



Stagner-Orsborn
Buick-Pontiac-GMC
30 YEARS IN HEREFORD
See Us And SAVE
142 MILES AVE. HEREFORD, TEXAS
PHONE 364-0990
KEEP THAT GREAT GM FEELING WITH GENUINE GM PARTS
GM QUALITY SERVICE PARTS
GENERAL MOTORS PARTS DIVISION

CHRISTIAN RADIO

KZOL Farwell 1570 On Your AM Dial

Gospel Music and Teaching Programs.
ALL DAY EVERY DAY

12:00 Noon Jimmy Swaggart
2:00 p.m. 700 Club
9:00 a.m. J. Vernon McGee
9:45 a.m. Morris Means
10:45 a.m. Kenneth Copeland
4:30 p.m. Contemporary Gospel Music

Double Ring Ceremony Unites Beth Cranfill, Clark Kaufman

Jeanne Beth Cranfill of Dumas, Texas and Lee Clark Kaufman of Richardson, Texas, exchanged wedding vows Saturday, May 26 at 7 p.m.

The double ring ceremony was performed in the First United Methodist Church of Dumas by Rev. J. Frank Peery, pastor.

The bride is the daughter of Dr. and Mrs. General Lee Cranfill of 211 Bailey, Dumas, Texas.

The bridegroom is the son of Mr. and Mrs. Ferd Kaufman of 1216 Mohawk, Richardson, Texas.

The church was decorated with a center arrangement of pink and dusty rose summer flowers in brass urns. The arrangement contained snapdragons, pink and dusty rose carnations, roses, miniature carnations, daisies and baby's breath. A background of arched and seven branch candelabra was placed behind the flowers and choir rail. The aisles were decorated with hurricane candelabras with swags of mixed flowers.

Given in marriage by her father, the bride wore a formal length gown of ivory chiffon designed with a Victorian neckline and a fitted bodice of alencon lace. The long fitted sleeves extended to points over the hands. Clusters of seed pearls accented the bodice and sleeves. The skirt fell unadorned to the hemline, sweeping to back fullness and extending into a chapel length train. Buttons enhanced the back closing of the gown.

Her veil was a matching lace with seeded with pearls. The lace edged veil extended past the train and was enhanced by appliques of lace.

The bride carried a cascade bouquet of white roses, gardenias, smilax and gypsophila. The bouquet was carried atop a Bible carried by her mother in her own wedding.

The bride carried a ring which her grandmother, Mrs. J.G. McFarland wore when she was married 50 years ago and a handkerchief belonging to her grandmother, Mrs. V.R. Jordan.

Courtney Vann Cannon of Austin served as the maid of honor.

Bridesmaids were Katherine Louise Horton of Lubbock, cousin of the bride, Pamela Kay Forbus of Dumas, Andrea Elizabeth Lambert of San Antonio, Janis Elizabeth Kaufman of Richardson, sister of the groom, and Mary Grace Kaufman of Richardson, sister of the groom.

The bridesmaids carried clutch bouquets of mixed summer flowers in shades of pink and dusty rose with gypsophila. The maid of honor's bouquet was same as the bridesmaids' but contained accents of white.

Kerry Bruce Pierson of Richardson was the best man.

Groomsmen were Ben Jordan Cranfill and General Lee Cranfill, III, brothers of the bride from Dumas, Henry Hollis Horton, III, of Austin, cousin of the bride, John Riddick of Dallas and Paul Pierson of Old Ocean, Texas.

Serving as ushers were James Christian Barnett and Robert Kyle Barnett, both cousins of the bride from Friona, Mark Reid of Richardson and Joe Lew of San Antonio.

John David Barnett of Friona, cousin of the bride, was the ring bearer.

Candlelighters were James Christian Barnett of Friona, cousin of the bride and Mark Reid of Richardson.

Gary James of Amarillo, organist, accompanied Karl Dent of Denton, soloist, as he presented traditional wedding selections.

The mothers of the couple wore mixed summer flowers and baby's breath corsages.

Wedding guests were registered by Tracy Horton of Friona, cousin of the bride, and Rebecca Lincoln of Richardson, cousin of the groom.

Guests at the reception were registered by Sunny Horton of Friona, cousin of the bride, and Kimberly Gay Barnett of Friona, cousin of the bride.

The reception was held on the lawn of the Cranfill home.

The lattice gazebo was the focal point of the yard setting. The white lattice gazebo was decorated with soft hanging greenery and potted plants incorporated into the overall design. Lattice backdrops were used behind the gazebo and tables.

The bride's cake table was under the gazebo. The table was covered with a floor length cloth and ivory lace overlay. The lighted fountain was positioned in one corner of the lawn. The fountain was encircled with a variety of foliage and flowering potted plants.

Spots, floods and tiny white midge lights were used throughout the yard and trees. The groom's table was covered with an ivory floor length cloth and square overlay of ivory lace patchwork. The groom's cake was an apricot coffee cake ring.

The champagne fountain was placed on a round table with ivory floor length cloth with lace overlay. The fountain was encircled with flowers and greenery. The table was positioned by one corner of the gazebo.

The small cocktail tables were covered with ivory floor length cloths

and print square caps. A floral arrangement with candles and hurricane globes were used on the individual tables.

The round punch table was covered with an ivory floor length cloth with lace overlay. A silver punch bowl accented the table setting. Nuts and mints were served from the punch table.

Food tables were placed under the porch. The tables were covered with ivory cloth with print runners and held floral centerpieces and five branch silver candelabras.

Following a wedding trip to Hawaii the couple will reside in Dallas, Texas.

The bride is a graduate of Dumas High School and attended Converse College in Spartanburg, South Carolina and graduated from the University of Texas College of Pharmacy in May 1979.

The bridegroom is a graduate of J. J. Pearce High School, Richardson.

He attended Texas A&M and graduated from the University of Texas College of Pharmacy in May.

Members of the houseparty were Mrs. Henry Hollis Horton, Jr., Mrs. James Wesley Barnett and Mrs. Marvin Ray Jordan, aunts of the bride from Friona; Mrs. Bob Lincoln of Richardson and Mrs. Albert Raymond of Conway, Arkansas, aunts of the groom.

Also, Mrs. Karl Kent of Denton and Mrs. Peter Taylor of Tulsa, Oklahoma, cousins of the groom; Mrs. Paul Pierson of Old Ocean, Texas; Mrs. Judy Jordan McBeth of Amarillo, cousin of the bride; Mrs. Bobby Ray Jordan of Hereford; Mrs. John Bill McFarland of Austin.

Also, Mrs. Bill Forbus, Mrs. Robert Kerns, Mrs. Jimmy Wells, Mrs. Ken Morrison, Mrs. Gray Johnson, Mrs. Jimmy Crabb, Mrs. Delbert Lewis, Mrs. Jerry Boles, Mrs. Mike Salim, Mrs. Jerry Keith, Mrs. Don Blair and Mrs. Collier Phillips, all of Dumas.

The bride's grandparents were special guests. They were Mr. and Mrs. John Granville McFarland and Mr. and Mrs. Virgil Ray Jordan, all of Friona. Her grandmothers wore white baby rose corsages.



DEBRA DIANE MENEFFEE graduated May 15 from Fort Towson High School. She is the daughter of Mr. and Mrs. Dwain Menefee, Fort Towson, Oklahoma. She plans to attend Southeastern Oklahoma University where she earned a scholarship. During her four years in High School she has been active in FHA, FTA, FCA, basketball, volleyball and tennis. She was co-editor of the Arrow staff, nominated best all-around her freshman year and was named "Miss Maize Days" 1978. Her senior year, she was in the Oklahoma Honor Society and graduated in the top ten per cent of the class. Debra received the typing award, tennis award, tennis sportsmanship award, was elected Miss Fort Towson High, most likely to succeed, FFA Sweetheart runner-up, senior carnival queen and received medals in basketball, tennis and volleyball.

REHEARSAL DINNER

A rehearsal dinner was hosted by the groom's parents, Mr. and Mrs. Ferd Kaufman, at the Amarillo Club in Amarillo on Friday evening.

Courtesies Fete Clark Kaufmans

Pre-nuptial courtesies honoring Mr. and Mrs. Lee Clark Kaufman included a shower in the home of Mrs. Gray Johnston of Dumas.

Mrs. Kaufman is the former Jeanne Beth Cranfill.

A brunch was held in the home of Mrs. John McFarland of Austin.

A tool shower honored the groom in the home of Dr. and Mrs. William Fackler of Richardson, Texas.

A luncheon was held in the home of Mrs. Robert Kerns of Dumas and a luncheon was also held in the home of Mrs. H.H. Horton, Jr. of Friona.

A dinner was held in the home of Mr. and Mrs. Bob Lincoln of Richardson, Texas.

A bridesmaids' luncheon and a gentlemen's buffet were held on the day of the wedding in the homes of Dr. and Mrs. Bill Forbus and Mr. and Mrs. Jimmy Wells.



Mrs. Lee Clark Kaufman

HOT SALE DAYS

CHILTON REPAIR MANUALS

1979 IMPORT AUTO #6578
Sug. List \$18.95

1979 TRUCK & VAN #6698
Sug. List \$18.00

Deluxe hardcover editions

CARQUEST MOTOR OIL
10W40 ALL-SEASON OR HD30 WT.

SPECIAL YOUR CHOICE 64¢ qt.

AUDIOVOX
Sound is our name you know it.

SOUND EXPLODER
Car stereo power amplifier.
25 watt stereo (12.5 per channel).

Sug. List \$38.00
24.88

turtle wax

LIQUID AUTO WAX
World's largest selling liquid auto wax. Giant 18 oz. size.

LIMITED QUANTITIES
Sug. List \$3.85
1.99

FREON RECHARGE KIT
14 oz. freon, lock valve, charge line with safety check, dispensing valve, instructions.

5.99

Duro SUPER GLUE
Bonds in seconds.

#SUPA
99¢

CARQUEST TONKA HOT PICKUP TRUCK
Famous Tonka heavy duty durability and quality.

LIMITED QUANTITIES
5.99

CARQUEST RAINCHECK POLICY Every CARQUEST Special is a bona fide offer. If we run out of an advertised item or fail to receive the merchandise, we will issue a "Raincheck" entitling you to the sale price. Rainchecks do not apply to items stated as being in limited supply. We reserve the right to substitute items of equal or better value in the event that our stocks of advertised specials become depleted.

Sale prices good at participating CARQUEST Auto Parts Stores through June 30, 1979.

Welch Auto Supply, Inc.

CARQUEST

247-2747 FRIONA, TEXAS W. HWY. 60

WE KNOW WHAT YOU MEAN WHEN YOU'RE TALKING PARTS

Saving Rates

Annual Rate	Savings Plan	Minimum	Annual Yield*
8.00%	8-10 Year Certificate	\$1,000	8.33%
7.75%	6 Year Certificate	1,000	8.06%
7.50%	4 Year Certificate	1,000	7.79%
6.75%	2½ Year Certificate	1,000	6.98%
6.50%	1 Year Certificate	1,000	6.72%
5.25%	Regular Passbook	10	5.39%

*When interest is accumulated and compounded. On certificate amounts withdrawn prematurely, federal regulations require interest reduction to passbook rate and forfeiture of up to 90 days' interest.

Tri-County
SAVINGS AND LOAN ASSOCIATION

Offices - MULSHOE FARMELL FRIONA LITTLEFIELD

For more production, less grain loss
Here's a combination that pays.

A Cat 3208 Diesel Engine in a Sperry New Holland TR70 combine gives you the combination that pays — big displacement power and Twin Rotor™ combine harvesting efficiency.

The 636 cubic inch 3208 gives the TR 70 pulling power for high production harvesting. Its Cat no-adjustment fuel system delivers top fuel economy. And continuing product improvements add to proven 3208 dependability.

With the TR 70, you can harvest with less damage to corn, beans and small grain. Unique Twin Rotor combine design delivers less crop loss and bigger returns for you.

Put this profitable combination to work in your fields. Ask us for more information about the dependable Cat-powered TR 70 combine.



SPERRY NEW HOLLAND
HEREFORD

HIWAY 385 SOUTH 364-4001

Caterpillar, Cat and are Trademarks of Caterpillar Tractor Co.

SUMMER REUNION SALE

SECOND BIG WEEK!!

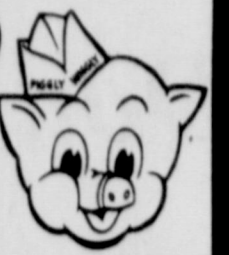

SHURFINE ALL PURPOSE FLOUR **59¢**
5 LB. PAPER BAG

SHURFINE SALAD DRESSING **79¢**
32 OZ. JAR

SHURFINE CUT GREEN BEANS **3/89¢**
16 OZ. CANS

SHURFINE 1 PLY ASSORTED PAPER NAPKINS **19¢**
60 CT. PKG.

SHURFRESH POTATO CHIPS **59¢**
8 OZ. TWIN DIP STYLE PLAIN OR FOR DIPS PAK

SHURFINE RICH THICK TOMATO CATSUP **79¢**
32 OZ. BTL.

SHURFINE EARLY HARVEST SWEET PEAS **3/17**
17 OZ. CANS

SHURFINE HAMBURGER PICKLES **69¢**
SLICED DILL 32 OZ. JAR

SHURFINE PREPARED MUSTARD **2/69¢**
16 OZ. JARS

PRODUCE PICKS GOLDEN RIPE BANANAS **29¢**
LB.
CALIFORNIA SUNKIST ORANGES **3/100**
LBS.
NEW CROP SWEET YELLOW ONIONS **2/29¢**
LBS.
CALIFORNIA GOLDEN CARROTS **25¢**
1 LB. PKG.

CANNED HAM

SHURFRESH FULLY COOKED HAM **579**
3 LB. CAN

SHURFRESH QUALITY BEEF FRANKS or BOLOGNA **109**
12 OZ. PKG.
SHURFRESH QUALITY MEAT FRANKS or BOLOGNA **99¢**
12 OZ. PKG.

SHURFINE EVAPORATED MILK **2/77¢**
13 OZ. CANS

SHURFINE MACARONI & DINNERS **4/1**
7 1/4 OZ. BOXES

SHURFINE APPLESAUCE **59¢**
25 OZ. JAR

SHURFINE FRUIT COCKTAIL **49¢**
16 OZ. CAN

SHURFINE YELLOW CLING PEACHES **49¢**
16 OZ. CAN

SHURFINE PUNCH/ DRINK **2/1**
46 OZ. CANS ORANGE/ GRAPE

SHURFINE PORK & BEANS **4/1**
16 OZ. CANS

SHURFINE WHOLE SWEET PICKLES **89¢**
22 OZ. JAR

SHURFINE SALTINE Crackers **2/1**
16 OZ. BOXES

--FROZEN & DAIRY--

SHURFINE FROZEN ORANGE JUICE **69¢**
12 OZ. CAN

SHURFINE FROZEN SPEARS BROCCOLI **39¢**
10 OZ. CTN.

SHURFINE FROZEN NON-DAIRY CREAMER **4/1**
16 OZ. CTNS.

SHURFINE FROZEN CRINKLE CUT POTATOES **69¢**
32 OZ. PKG.

SHURFINE FROZEN GLAZED DONUTS **69¢**
14 OZ. BOX

SHURFINE FROZEN 12 OZ. PKG. FILLETS **99¢**
BATTER DIPPED FISH

SHURFRESH IN QUARTERS 2-16 MARGARINE **89¢**
OZ. CTNS.

SHURFRESH CHEESE SPREAD **199**
2 LB. LOAF

SHURFRESH 2-7 1/2 OZ. PEANUTS **89¢**
BAGS

SHURFRESH VANILLA WAFERS **79¢**
2-10 OZ. PKGS.

SHURFINE BLACK PEPPER **69¢**
4 OZ. CAN

SHURFRESH BONELESS HAM **199**
HALVES SECTIONED LB. & FORMED

SHURFRESH PORK SAUSAGE **99¢**
1 LB. ROLL

SHURFRESH CHICKEN OR HAM SALAD **89¢**
8 OZ. CRT.

SHURFRESH SLICED BACON **129**
1 LB. PKG.

SHURFRESH LUNCH MEATS **79¢**
6 OZ. PKG.

SHURFRESH PIMENTO OR JALAPENO SPREAD **89¢**
7 1/2 OZ. CRT.

SHURFINE FROZEN CORN **69¢**
ON THE COB 4 EAR PKG.

SHURFRESH BISCUITS **89¢**
BUTTERMILK OR SWEETMILK 8 OZ. CANS

SHURFINE WHOLE SWEET PICKLES **89¢**
22 OZ. JAR

SHURFINE SALTINE Crackers **2/1**
16 OZ. BOXES

SHURFRESH HALFMOON CHEDDAR/LONGHORN COLBY CHEESE

SHURFRESH ICE CREAM **89¢**
10 OZ. PKG. 1/2 GAL. SQ. CTN.

SHURFINE SOFT DRINKS

REGULAR OR DIET 12 OZ. CANS **7/100**

ENERGY CHARCOAL BRIQUETS **99¢**
10 LB. BAG

ENERGY CHARCOAL LIGHTER **69¢**
32 OZ. CAN

SHURFINE CHUNK LIGHT TUNA **69¢**
6 1/2 OZ. CAN

SHURFINE HOUSEHOLD BLEACH **49¢**
64 OZ. JUG

SHURFINE 49 OZ. BOX DETERGENT **99¢**



MISSES SIZES **397** pair
WOMEN'S SIZES **447** pair
Women's & Misses' EVA KLONK SANDALS

Comfortable, fun-to-wear sandals! Summertime colors, reinforcing gold ring design!



PIGGY WIGGLY

PERRYS

SALE STARTS TODAY . . .

134-LOCATIONS

IF YOU WANT VARIETY WE HAVE IT . . .

Specials on every counter!

65
YEAR

th ANNIVERSARY
SALE

ASSORTMENT
METAL
PICTURE
FRAMES

YOUR
CHOICE

PERRY'S
SALE
PRICE

67^c



5 x 7 or 8 x 10

17" HAND PAINTED

ELECTRIC
HURRICANE
LAMP

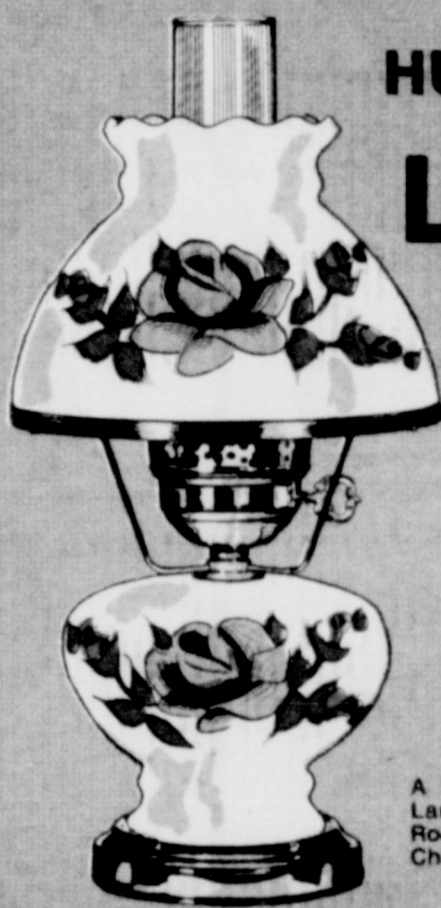

PERRY'S
SALE
PRICE

9⁸⁸

A Great Special . . . These
Lamps will give that Living
Room or Bedroom a new look!
China floral design.

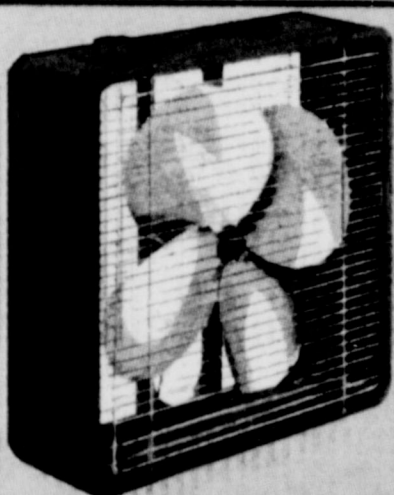

20-INCH 2-SPEED
BOX ELECTRIC
FAN

Precision Blades . . . Convenient 2-
Speed Position Rotary Switch also
with a heavy duty Strap Handle.

PERRY'S
SALE
PRICE

19⁸⁸

Supplement To: The Tyler Courier-Times-Telegraph, The Gilmer Mirror, Lufkin News, The Panola Watchman, East Texas Light, San Augustine Rambler, San Augustine Tribune, Angleton Times, The Brazosport Facts, Bay City Tribune, El Campo Leader News, The Wharton News, Herald Coaster, The Longview Daily News or Longview Morning Journal, The Winnboro News, The Hearne Democrat, Aikin Advertiser, Fayette County Record, Brenham Banner Press, Burleson County Citizen-Tribune, Summerville Tribune, Pictorial Press, Navasota Examiner, The Orange County Leader, Penny Record, Vidorian Shopper, The Illustrated Press, Polk County Enterprise, The Mexia Daily News, The Ennis Daily News, Athens Daily Review, The Daily Progress, The Daily Sentinel, Bowie County News, The Citizens Journal, Jefferson Jimpiculet, Wood County Record, The Grand Saline Sun, Edgewood Enterprise, Free Press Giddings Times, Liberty Gazette, Livingston News, Marlin Democrat, Ft. Stockton Pioneer, Del Rio News-Herald, The Taylor Daily Press, Lockhart Post Register, The Gonzales Inquirer, Tribune-Herald, Press-Reporter, Mineral Wells Index, The Temple Daily Telegram, Waco Tribune-Herald, Stephenville Daily Empire, The Mid-Valley Town Crier, Eastland Telegram, Ranger Times, Cisco Press, Rising Star, Coleman Democrat-Voice, Yoakum Herald-Times, The Curro Record, Beeville Bee-Picayune, Port Lavaca Wave, Gatesville Messenger, Cameron Herald, The Citizen, The Newsboy, The Childress Chronicle, Lamb County Leader News, Plainville Daily Herald, The Snyder Daily News, Stamford American, Colorado City Record, The Friona Star, Dewitt County View, Ozona Stockman, Matlis News, Hillaboro Reporter, The Laredo Times, Tulia Herald, Sinton Enterprise, Sinton San Patricio County News, Breckenridge American, Bellville Times, Wells Point Chronicle, Teague Chronicle, The Galveston County Advertiser, The Liberty Vindicator, The Highlands Star, Honisville Item, Inc., The Comanche Chief, The Community News, Mount Pleasant Daily Tribune, Lynn County News, The Woodlands Sun, Itasca Item, Whitney Messenger, The Karnas City Citation, Hugo Daily News, Aransas Pass Progress, The Ingleside Index, Sentinel, The Memphis Democrat, Banner Publishing Co., The Shamrock Texas, Floyd County Herpetian, The Knox County News, Muleshoe Publishing Co., San Marcos Daily Record, The Devil's River News, The Daily News Telegram, The Lockney Beacon, The Seguin Enterprise, Bossier Press, The Pittsburg Gazette, Daily Citizen, Lakeside News, The Rockwall Success, The Nixon News, Haskell Free Press, Journal, Westlake Moss Bluff News

LUGGAGE SPECIAL!! 3-HANDSOME CASES

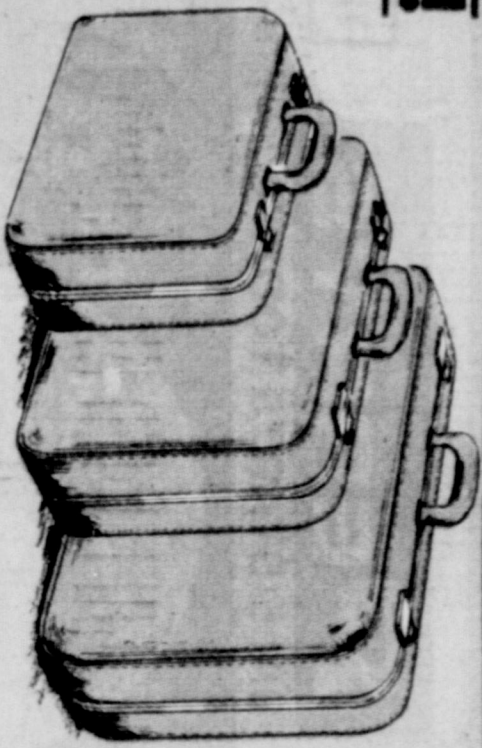

BUY THE SET OR SEPARATE PIECES

Colors: Tan, Blue or Green

16" VANITY

4 88

21" WEEKENDER

7 88

24" PULLMAN

8 88

PERY'S
SALE
PRICE

PERY'S
SALE
PRICE

PERY'S
SALE
PRICE

THE BICYCLE SCARF

These Scarves give the height needed for a flattering appearance.



• PRINTS
• SOLIDS

88¢

The New
Foster Grants
are here!



Come in and see the new collection of Foster Grant sunglasses - the worlds most popular line. Get behind the pair you love the most - and expect a little envy!
79¢ to \$7.00

DIAPER SHIRTS

100%
COTTON



53¢
EACH

Soft Knit Diaper Shirt, gripper front... attractive nursery print... Sizes S, M, L.

IRREGULARS WASH CLOTHS

ASSORTED
COLORS



43¢
EACH

FRUIT OF THE LOOM

\$1.00 off on Regular Price of the above men's Tee Shirts and Knit Briefs.



3 for 4.99
3 for 3.99

TOWELS

FANCY SECONDS!
HAND
TOWELS

77¢

ASSORTED COLORS

SPECIAL PURCHASE

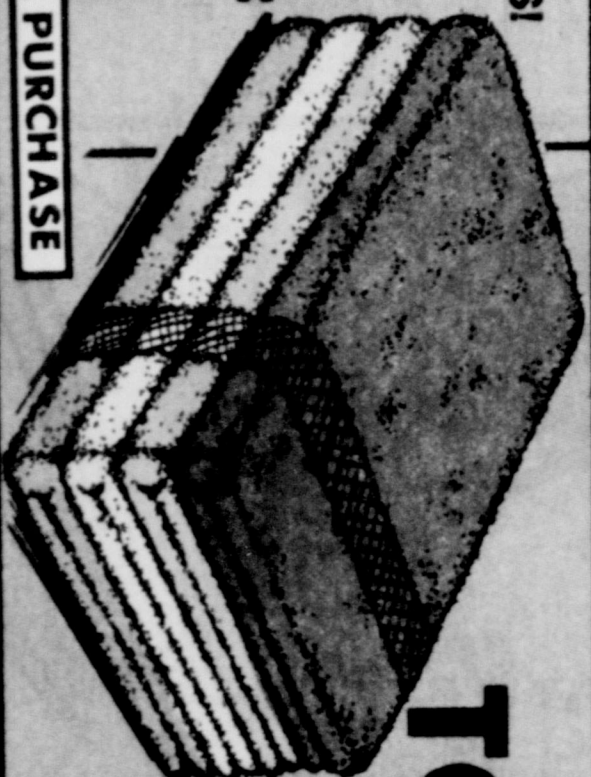

BIG FANCY TOWELS

IRREGULARS

77¢

Irregular Towels but the quality is excellent. Solids, Jacquards and Colorful Prints. You'll find a color that will blend perfectly with your bathroom. Hurry! Our quantity is limited.

PERRYYS

IF YOU WANT VARIETY WE HAVE IT...

20-OZ. CRYSTAL DIMPLE PARTY MUGS

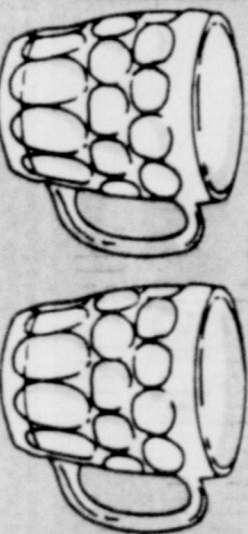

These lovely crystal mugs will help you enjoy refreshing, cooling drinks on all occasions.

88¢
EACH

FRAMED PICTURE ASSORTMENT

Each picture is framed with 2" all wood molding in natural finish - and comes in Landscapes, Still Life, Florals, and Early American.

Your Choice

2 88

SIZES
12x16
16x20
12x24



PLASTIC FLORENTINE WALL PLAQUES

Make your own Professional decorator wall ensemble from these plaques.

2 1 00

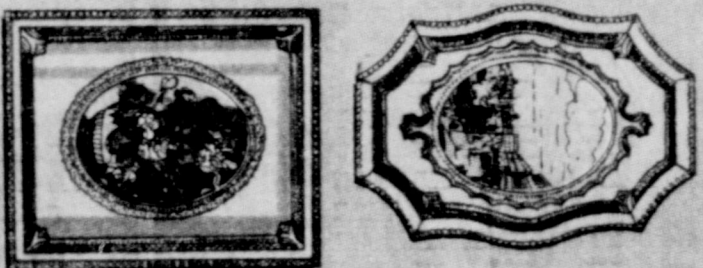

3-RING - 100 PAGES AMERICAN FAMILY PHOTO ALBUM

Stores up to 600 photos
(3 1/2" x 3 1/2")



• BROWN
• IVORY

6 88

PERRYS

IF YOU WANT VARIETY WE HAVE IT...



PLASTIC HOUSEWARES ASSORTMENT YOUR CHOICE

° Oval Laundry Basket ° 12 Qt. Waste Basket ° 14 Qt. Floral Waste ° 12 Qt. Twin Spout Pail ° Dishpan

93¢

PERRY'S SALE PRICE

ASSORTED COLORS

NEW TWIN PACK "ICE QUICK" TRAYS

° Twist to free cubes ° Designed for easy stacking ° 14 Large Ice Cubes

67¢

PERRY'S SALE PRICE



65th ANNIVERSARY

SATTEE

Our desire is to have every item as advertised. However, due to the various sizes of our stock, we may not have the exact quantity of each item. We reserve the right to substitute each item, and each item may be minor variations.

LADY Seymour

TRAVELER IRONING TABLE

SIZE 12" x 36"

COMPLETE WITH PAD AND COVER

Ideal for travelers and college students. Plus easy storage.

688¢

PERRY'S SALE PRICE



1/2" 50-FOOT GARDEN HOSE

100% Vinyl Solid Brass Couplings... Fully Warranted

227

PERRY'S SALE PRICE



EVEREADY BATTERIES

C AND D SIZE

2 FOR **47¢**

PERRY'S SALE PRICE



PLASTIC ASSORTMENT

YOUR CHOICE

18¢

PERRY'S SALE PRICE

SHOP EARLY

° 8" Bowls ° 6" Tub Dishpan ° Turnblers ° Catsup Dispenser ° Mustard Dispenser ° Salad Fork & Spoon ° Butter Dish ° Salt & Pepper ° Soap Dish



30-OZ. SIZE RAINBOW PLASTIC TUMBLERS

For use with hot or cold beverage... Ideal for Summer use.

2 FOR 100¢

PERRY'S SALE PRICE



Low Price

SECONDS IN GENUINE AMERICAN **ironstone DISHES**

YOUR CHOICE

47¢

PERRY'S SALE PRICE

12" CHOP PLATTER

DECORATED CUPS

DINNER PLATES

VEGETABLE BOWLS

6 1/2" IN. CEREAL BOWLS

27¢ EACH

16-PIECE IRONSTONE DISH SET

888

PERRY'S SALE PRICE



Great Bargains for DAD!

Father's Day
June 17th

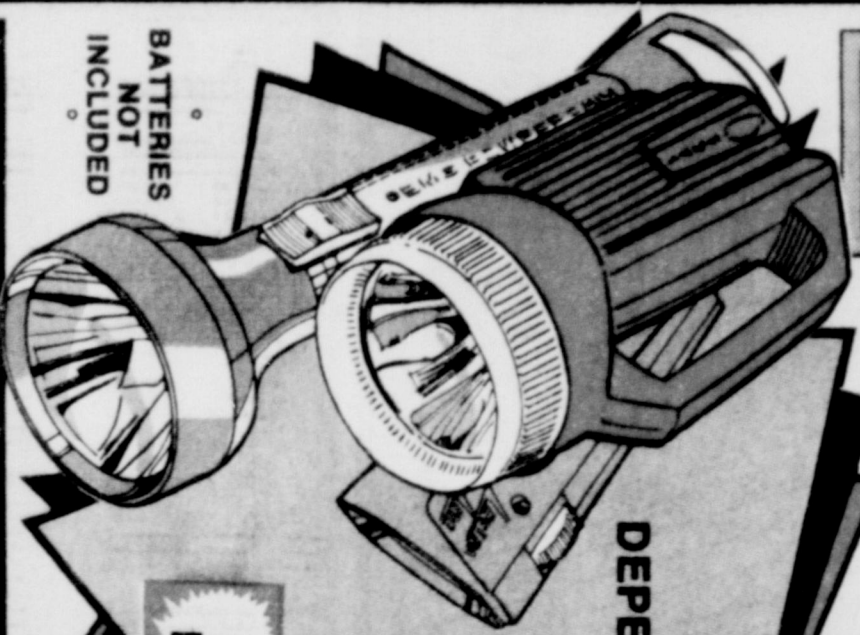

8-STYLES
DEPENDABLE QUALITY
FLASHLIGHTS
MADE
AMERICAN
YOUR CHOICE

PERRY'S
SALE PRICE

87¢
EACH

PERRY'S
SALE PRICE

8.99
SET



11-PIECE COMBINATION
WRENCH SET
BY STEEL CRAFT

With Vinyl Roll-Up Pouch for easy storage.

STEEL CRAFT
TOOLS

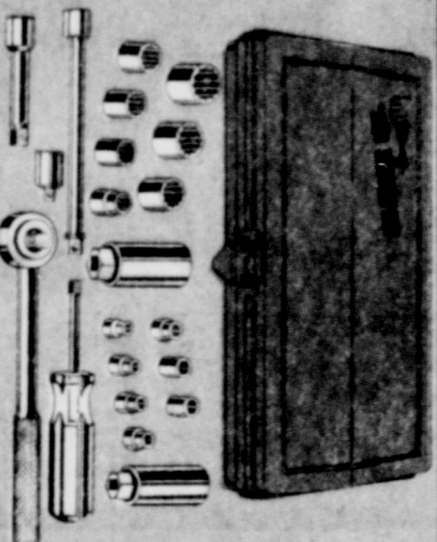

**SUPER QUALITY 21-PIECE
SAE SOCKET SET**

Consists of following: 7—1/4" Drive Sockets, 3/16", 7/32", 1/4", 9/32", 5/16", 11/32", 3/8", 7—3/8" Drive Sockets, 3/8", 7/16", 1/2", 9/16", 5/8", 11/16", 3/4", 1—Reversible Ratchet (3/8" Drive), 8 in., 1—6" Extension, 1—5" Extension, 1—3/16" Spack Plug Socket (3/8" Drive), 1—3/8" x 1/4" Adapter, 1—Spinner Handle (1/4" Drive), 1—Metal Case.

PERRY'S
SALE PRICE

6.97
SET



**60" ROUND
WADING
POOL**

PERRY'S
SALE PRICE

5.99

SAVE
\$2.00

Rugged round pool, pools with vinyl liner. Tough seamless polyethylene construction, guarantees easy cleaning and durability. . . Proven favorite with kids. . . Kids and stores easily. . . backyard favorite all summer long.

**LAWN
CHAIRS**

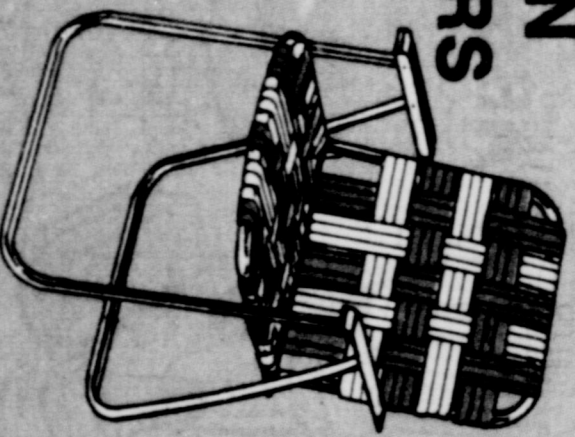

PERRY'S
SALE PRICE

5.27
EACH

Good Quality, Aluminum Plus 6-4-4 Weather-Tested Webs.

PERRY'S

IF YOU WANT VARIETY WE HAVE IT ...

FURNITURE TO FIT YOUR LIFESTYLE

EASY TO ASSEMBLE SHELF

48" MUSIC STAND
47 3/4" W x 15 3/4" D x 25 3/4" H

NO TOOLS ARE NEEDED TO ASSEMBLE



BOOK CASE
29 3/4" W x 9 1/2" D x 29 3/4" H

3 SHELF

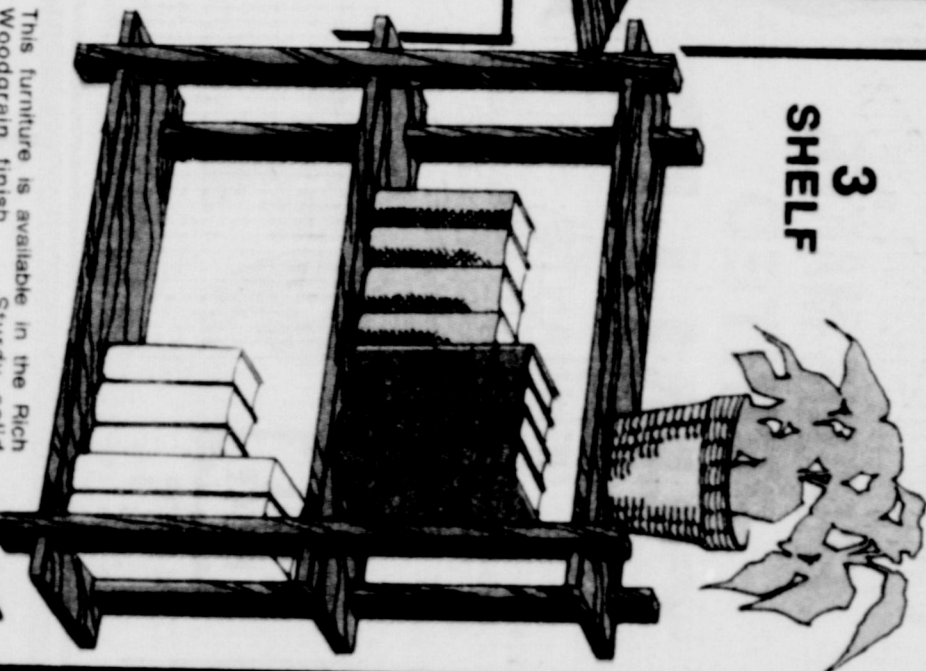

END TABLE
21 3/4" H

YOUR CHOICE

PERRY'S
SALE PRICE

17.88
EACH

This furniture is available in the Rich Woodgrain finish. . . Sturdy solid construction.

50¢ Cash Refund



2.5 OUNCE
RIGHT GUARD® STICK DEODORANT

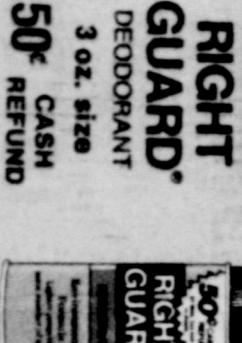

3 OZ. SIZE
RIGHT GUARD® DEODORANT

50¢ CASH REFUND

PERRY'S
SALE PRICE

8.1¢

**PADDED TOP
BAR STOOLS**

PERRY'S
SALE PRICE

10.47
EACH

This is a great buy in stools. . . Your Choice in 24" or 30" High and in Fruitwood Finish. . . A Great Buy.

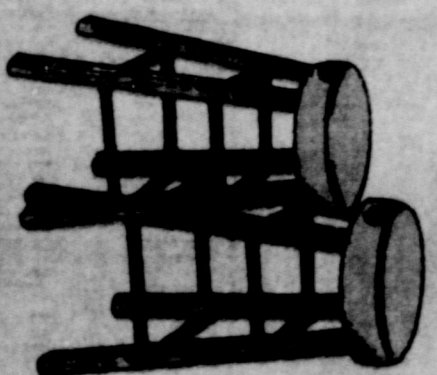

PERRY'S

SALE STARTS TODAY ...

IF YOU WANT VARIETY WE HAVE IT ...

Specials on every counter!

FABRIC SALE

Guaranteed 1st. Quality

FAMOUS MAKER PRINTED CHALLIS

REMNANTS

SUMMER COLORS, POLYESTER BLEND, .45" WIDTH, 1-10 YARDS LENGTHS ... SAVE NOW DURING THIS SALE.

PERRY'S SALE PRICE

99^c YD.

ITEM #643F

100% POLYESTER PRINTS AND SOLIDS INTERLOCK KNITS

REMNANTS

TODAY'S EASY CARE FASHION FABRIC, 60" WIDE ... ELEGANT PRINTS AND SOLIDS ... 100% POLYESTER MACHINE WASH COMES IN DRESSMAKER LENGTHS.

PERRY'S SALE PRICE

99^c YD.

HURRY FOR BEST SELECTIONS!!!



4-OZ. SIZE FINAL NET

- REGULAR
- ULTRA HOLD

PERRY'S SALE PRICE

77^c

36-COUNT



PERRY'S SALE PRICE

76^c

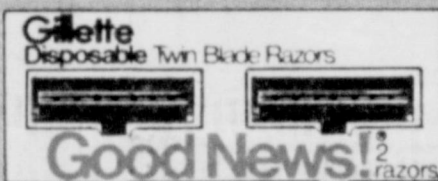

Good News! 2 razors

PERRY'S SALE PRICE

33^c



BAN ROLL-ON ANTI-PERSPIRANT DEODORANT

1-OZ. SIZE

PERRY'S SALE PRICE

55^c



BIC BUTANE LIGHTER

PERRY'S SALE PRICE

48^c



2 - 10-OZ. BOTTLES TWIN PKG. VASELINE INTENSIVE CARE LOTION

TOTAL 20-OZ.

PERRY'S SALE PRICE

1¹⁰