

# The Castro County News

66th Year—No. 19

Dimmitt, Texas, Thursday, August 23, 1990

14 Pages Plus Supplements

## City suit settled; precincts drawn

# 1:1

By Don Nelson

Except for the Nazareth Labor Day Picnic Sept. 3, our summer celebrations are all behind us.

Now it's time to turn our eyes toward the Castro County Centennial. Our county will be 100 years old next year.

Actually, the planning has been going on almost a year already, and the Centennial Commission has been holding regular meetings since May. The county commissioners' court appointed Dimmitt Postmaster Bill Sava and me to serve as co-chairmen of the commission.

Right off the bat, we were contacted by an out-of-state production company that offered to come in and stage a big two-week centennial blast for us—for \$35,000.

We told them thanks, but no thanks.

We're going to have a "home grown" centennial celebration that will last all year and go to all our communities. It will be built mainly on existing celebrations — Hart Days, the Nazareth German Folk Festival, Harvest Days, the Fourth of July — and also will include special events at most of our churches and crossroads communities.

If it's to be a successful, meaningful observance, then we've got to have the ideas, input and help of hundreds of volunteers.

That's where you come in. You probably have talents and abilities that the centennial planners don't know about. If you have any special capabilities—or just the desire to be a part of it—we need your help.

The centennial celebration is in the planning and organizing stages now. Working committees are being formed, and we've got a long list of ideas that need to be acted upon, with more ideas surely to come.

Here are some of the things the Centennial Commission has on tap so far:

—A contest to pick an official centennial logo, which will be used by our post offices, newspapers and businesses to call attention to our county's 100th anniversary year. The contest will begin next month and the logo will be unveiled at the annual Dimmitt Chamber of Commerce Banquet in January. Janet Mitchell of Hart is heading up the logo contest committee.

—Construction of a centennial gazebo, or bandstand, on the courthouse square—reminiscent of the bandstand that originally stood there. County Judge Polly Simpson is heading up this project, and is going to need a lot of volunteers to help.

—A "memorial plaza" on the courthouse square, with engraved bricks or granite tiles commemorating past and present families and individuals. Robert Hawkins of Hart is in charge of this project.

—Creation of a Centennial Chorus and a troupe of Centennial Players to perform at special events around the county during 1991. Bill Sava, who will direct the Centennial Players, already has written several original songs and skits based on county historical events and characters. The director and

(Continued on Page 14)

## DHS ranked among top 10% of schools

Dimmitt High School has been ranked among the top 10% of schools in the state and has been nominated as a contender for special recognition from the Governor's Educational Excellence Committee.

The school is now eligible to contend for excellence awards that include a cash allocation ranging from \$10,000 to \$100,000, presentation of a Texas Educational Excellence flag, and recognition at a formal ceremony at the Capitol in Austin.

DHS's nomination was based on gains in TEAMS scores and SA-

T/ACT scores over the last three years.

DHS Principal R.L. Stockstill revealed that the application asks for information on what initiatives have been exercised by the school to encourage parents to provide an effective learning environment at home; what programs have been developed to encourage parental/community/business involvement; what major factors have contributed to the academic accomplishments of the school; and what obstacles or barriers have been overcome to achieve such success.

(Continued on Page 12)

## Broadstreet mounts write-in campaign

Harold E. Broadstreet of Dimmitt has filed as an official write-in candidate for county judge in the Nov. 6 general election.

Broadstreet filed as an independent candidate, challenging incumbent Polly Simpson, who was unopposed on the March 13 Democratic Primary ballot. No one filed for the office on the Republican Primary ballot.

"I think our county government has gotten into a rut, and is suffering from tunnel vision, with no new ideas. There's a need to expand their vision for future growth," Broadstreet said.

Broadstreet said he has had some encouragement in his bid from several local citizens.

A resident of Dimmitt for 17 years, Broadstreet moved to Lubbock in September 1987, but moved back to town in September 1989. He is employed as a traffic coordinator (dispatcher) by Braafladt Transport in Dimmitt.

In 1970, Broadstreet retired from the US Marine Corps after serving

21 years, including 17 years as a criminal investigator. He noted that part of his duties included budgeting experience.

"I will do my best, and if I can't, then I'll resign, plain and simple," Broadstreet vowed. "I'll see if I can improve the situation."



Harold Broadstreet

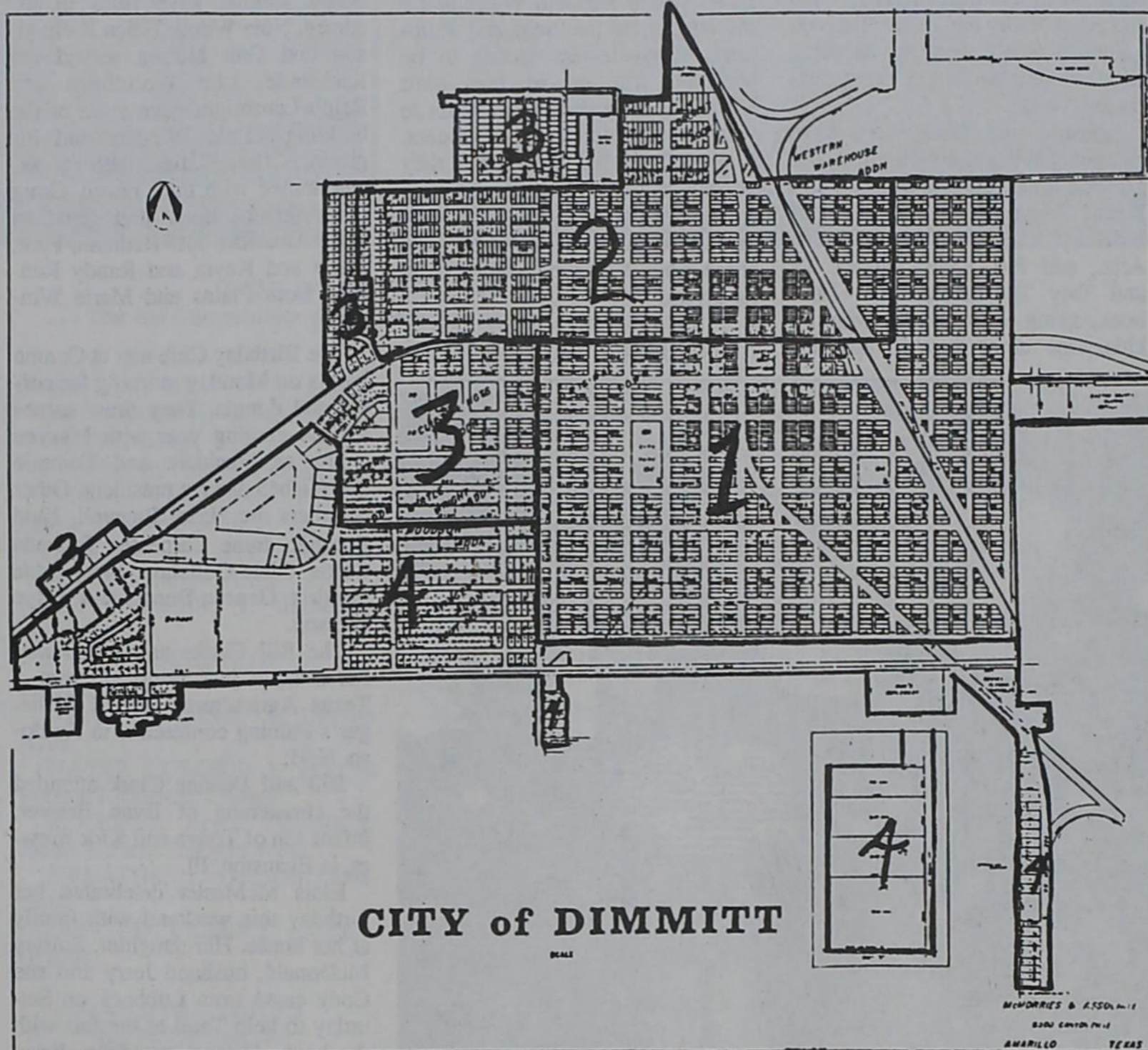

CITY of DIMMITT

NEW VOTING PRECINCTS FOR CITY OF DIMMITT

... One council member to be elected from each precinct, plus three at large

## School registration begins today

Summer vacation is nearly over and it is time to go back to school. Registration for the three county schools is starting today.

### Dimmitt

Dimmitt's school registration will be held today and classes will begin Aug. 28.

High school seniors will register between 1 and 1:45 p.m., juniors between 1:45 and 2:30 p.m., sophomores will register between 2:30 and 3:15 p.m., and freshmen will register from 3:15 to 4 p.m. The 1989-90 annual may be picked up during registration.

Registration will start in the auditorium with school pictures being taken, and the dress policy will be in effect.

Dimmitt Middle School will hold registration from 1 to 4 p.m.

At 1 p.m., grades four, five and six will register in the west section of the middle school. Supply list for grades four through six will be available at registration.

Seventh grade registration will be from 1 to 2:30 p.m. and eighth grade registration will be from 2:30 to 4 p.m. at the DMS library.

Middle school students may purchase meal tickets or pick up an application for free and reduced meals during registration.

A general registration for grades kindergarten through third will be from 1 to 4 p.m. at Richardson Elementary School. Bring a copy of your child's birth certificate, shot record and social security number to registration.

### Nazareth

Registration for Nazareth High School students will be Friday. Senior registration will be from 8:30 to 9:30 a.m., junior registration will be from 9:30 to 10:30 p.m., sophomore registration will be from 10:30 to 11:30 a.m., and freshmen registration will be from 1:30 to 2:30 p.m.

Grades kindergarten through eight will register on the first day of classes, Aug. 27 beginning at 8:20 a.m.

### Hart

Registration for Hart schools will be held Thursday.

Elementary students will register between 9 a.m. and noon at the elementary building.

Junior high and high school students will register at the high school library.

Seniors will register from 8:30 to 9:30 a.m., juniors will register from 9:30 to 10:30 a.m., sophomores

will register from 10:30 to 11:30 a.m., and freshmen will register from 11:30 a.m. to 12:30 p.m.

Eighth graders will register between 1 and 2 p.m. and seventh graders will register between 2:30 and 3:30 p.m.

Classes for Hart schools will start Aug. 27.

## Lumbrera to face only Kansas charge

Former Dimmitt resident Diane Lumbrera, accused of murdering as many as seven children, six of them her own, will only face evidence from one of the deaths in her upcoming trial in Kansas, set for Sept. 24.

Kansas Judge Stephen Nyswonger ruled Aug. 16 that evidence from six deaths that occurred in Texas cannot be admitted in Lumbrera's first-degree murder trial for the May 1 death of her son, Jose Antonio, 4, who was already dead when Lumbrera took him into a Garden City hospital emergency room.

Originally, the death was attributed to death by smothering, and Lumbrera was arrested May 5, but a subsequent autopsy ruled the death was by natural causes. Lumbrera was indicted June 15, after 2-1/2 days of testimony determined there was sufficient evidence for a trial.

The Kansas case stimulated interest in the earlier Texas deaths, and Lumbrera was indicted in three of the deaths Aug. 8 by a Parmer County grand jury, following extensive investigation and work by two pathologists, including Dr. Robert Bux. A bond of \$300,000 was set on the Texas charges.

Lumbrera had been free earlier

on \$50,000 bond on the Kansas murder charge, but she opted to surrender that bond and begin counting her jail time against any

(Continued on Page 12)



TAKING A BREAK FROM THE RACE—The "duck" poses with his friends (from left) Shae Odom, Rae Odom and Brook Moyers. The Duck Race, sponsored by the Kiwanis Club, helped raise money for various community projects throughout the year.

## Weather

Readings recorded at 7 a.m. daily for the preceding 24 hours.

	Hi	Lo	Pr.
Thursday	79	62	.34
Friday	84	60	.31
Saturday	84	60	
Sunday	85	56	.24
Monday	86	58	
Tuesday	87	60	
Wednesday	88	60	
August Moisture	2.52		
1990 Moisture	12.19		

KDHN RADIO  
US Weather Observer

# On the Go with Mary Edna Hendrix, 647-3343

Bobby and Wanda Murdock went to Steamboat Springs, Colo. to watch their daughter, Debbie Smith, play in the Select Care of Amarillo slow-pitch softball team. This was the Triple Crown National Tournament, for which they qualified by winning three tournaments in this area—Abilene, San Angelo and Lubbock. In Steamboat Springs they were defeated by teams from Florida and Michigan. The Murdocks reported nice weather, but it rained on them when they were returning home.

I attended the 50th wedding anniversary of Travis and Doris Hendrix in Slaton. They celebrated with a reception in the community room of the Citizens Bank in Slaton on Sunday, Aug. 12. This lovely event was hosted by their children, Travis Jr. and Teresa Hendrix of Ogden, Utah, Terry and Dee Hendrix of Goodwell, Okla., Jim and Cindy Schlatter of Wilsonville, Ore., and Brian and Susan Godinez of Austin. Other relatives there were from

New York, Arizona, New Mexico and Texas. I spent the night in Post with Jess and Gladys Hendrix. Sunday morning when we went to church, I visited with Paul Kenley's relatives, L.G. and Consie Thuett and Mary Gail. Also Nancy (Hendrix) and Ronald Thuett, who ate lunch with us, as well as David and Sue Vaughan and Kristin from Dallas.

Ida Arms from Norman, Okla., and Pleda Fox and family from Fort Worth came out to see "Texas" and came on to Dimmitt to visit Vaden and Aline Kirby and other relatives. Later, they all went to Sapulpa, Okla. to visit another relative, Jess Underwood.

Houston and Doris Lust have enjoyed having their children and grandchildren this summer—Ann, Keith, Tonya, Sean, Lindsey and Brittany Cayton from Gilbert, Ariz., and Flo, Kyle, Tanner, Ty and Trey Touchstone from Lubbock, along with all the Dimmitt kids. One night they all attended

"Texas." Oleta Gollehon brought the devotional at Canterbury Villa on Thursday morning. Her subject was "Morning Glories," taken from the 14th chapter of the gospel of John. Richard Young sang *How Great Thou Art*. Others participating were Phyllis Mooney, pianist, Irene Carpenter, Ysleta Ball, Connie Ivey, Bobbie Baldrige, Beral Hance and Mary Edna Hendrix.

Geneva Schaeffer and Jo Eddie Riley served cookies and punch Friday morning at the First State Bank, where Kenneth Wyatt had a showing of his paintings and sculptures. Kenneth was unable to be here, but his son-in-law, Matt Marshall, came over from Tulia to visit with interested customers. Matt married Jill Wyatt and they moved to Tulia recently to help Kenneth. I bought Veda Wyatt's cookbook, since I visited in their home when I was staying in Tulia for a year.

The Harvest Days celebration



**GOLDEN DAYS** — Members of Dimmitt High School's Class of 1940 held their golden anniversary reunion Friday and Saturday, with 13 attending both days. They enjoyed a hamburger supper at the home of James and Mildred Bradford Friday evening, then gathered at the Senior Citizens Center Saturday for the Harvest Days Parade, a class dinner, old pictures and their 1940 "class will and prophecy." Seated, from left, are Earlene Lust

Settle (who won the traveling trophy, coming from Hermitage, Tenn.), Cyble Bearden Gamblin, Elen Ivey Howell, Dorothy Sinclair Shannon, Eugenia James Beard and Ellene Ivey Schoenrock. Standing, from left, are Glen Exter, Trellis Summers, Ruth Mildren Beard Adams, Houston Lust, Herbert Mayfield, Glenn Williams and Irene Dixon Bradley.

was a big success again. The parade was also very good. I rode in the "Surrey with the Fringe on Top" with Edgar and Geneva Dennis and their grandkids, Chauncey and Dennis. The Pet Show was fun —Susie Phillips and her daughter came down from Amarillo and brought their three dogs, Salt, Pepper and Cinnamon. Kim Hays and children brought their four baby kittens and there was a baby skunk, a calf, and a beautiful pony.

The Castro County Museum held open house and served lemonade. Edgar Dennis gave rides in his surrey. Nola Wood, Helen Richardson and Gail Nelson served the lemonade. Lon Woodburn and Ralph Lambright gave tours of the buildings. Dale Winters and his group, "The Flatland Bluegrass" entertained with their music. Craig Cunningham, Betty and Jonathan from Amarillo, Jeff Redman, Pam, Jason and Kayla and Randy Redmon from Plains and Marie Winters.

The Birthday Club met at Connie Ivey's on Monday morning for coffee and donuts. They drew names for the coming year with Mauzee Youts as president and Tommie Sue Nisbett as vice president. Other members are Hazel Bagwell, Kate Beecher, Irene Carpenter, Jauvada Curtis, Oleta Gollehon, Mary Edna Hendrix, Geneva Dennis and Billy Wesson.

The Bill Clarks and the Danny Rices have just returned from a Texas Agriculture Council Manager's training conference in Ruidoso, N.M.

Bill and Deanne Clark attended the christening of Evan Brewer, infant son of Tonya and Kirk Brewer, in Evanston, Ill.

Elois McMaster celebrated her birthday this weekend with family at her house. Her daughter, Shirley McDonald, husband Jerry and son Cody came from Lubbock on Saturday to help Tami at the fair with the boys. Another grandson, Brian Cade, and his fiancée, Sandy Joiner, came up from Lubbock to help celebrate on Sunday. Jared and Tami made the cake and decorated it with dinosaurs. Grandma tried not to tell how old she is, but Tanner figured it out.

Friends of Rhonda Schaeffer gathered in the home of Connie

Merritt for a salad luncheon last Friday to wish Rhonda well as she and her children, Shanna, Shalyn and Shawn move to Lubbock. They were presented with a picture and a gold James Avery ring. Forty-five ladies brought salads and good wishes. On other days, Shanna's friends had a party for her at Amy Beck's home, and Shalyn was honored with a swimming party at Ruskin. Their many friends in Dimmitt will miss them.

Ben and Amelia Barrera and family enjoyed a visit from Amelia's relatives, including her mother, Lenor Garza, and brother, Xavier Garza of Rio Grande City, and her sister, Marcy Castillo from Edinburg.

At Dimmitt's First Christian Church Sunday night, Jeff Barringer and his wife Debbie from Missouri gave a presentation on their efforts to go to Zimbabwe, Africa as missionaries.

Jeff is the son of former Dimmitt minister Roy Barringer, who now resides in Hereford. Roy and his wife Noah were present for the evening service, along with their other sons, Randy and Greg, along with Randy's wife Beth and their baby daughter, and Jeff and Debbie's three children, Isaac, Sarah and Bethany.

Dr. and Mrs. Charles Vandiver, Anne-Marie Perrin, Louise Rodgers of Littlefield, Myrtle Lois Moran and Carole Dyer joined a group of eight for a trip to Germany, France and Luxembourg. Carole related:

Our trip extended from July 24 to Aug. 7. The group landed in Frankfurt, Germany, where we joined our European tour guides, Bill and Sally Wagner, who have lived on the European Continent 26 years and are Baptist Missionaries.

Our first overnight stop was in Kaiserslautern in southwest Germany, where many of the armed forces are stationed. On our first day, we enjoyed a very scenic cruise on the Rhine River and also visited the City of Mainz, which is 2,000 years old, and is the home of the Gutenberg Museum. We saw exhibits about the origins of writing, the printing press and books.

Munich, the capital of Bavaria, is very modern and progressive;

however, it has kept its quaint Bavarian atmosphere. It is a beautiful city. Here, we visited the Residence Museum, where we saw many very elaborate crown jewels. We also went through the Hofbrauhaus (Beer Garden) where Hitler made his first political announcement.

On July 28, we were in Oberammergau, where we saw the "Passion Play," which was definitely the highlight of our trip. The first Passion Play was in 1634 in fulfillment of a vow to perform "the drama of the sufferings and death of the Lord" if the pestilence, which had ravished the village, would cease. The pestilence did cease, and the Play has been given every ten years since 1640. Oberammergau is located in the foothills of the Alps, just a short distance from the border of Austria.

Also located in this area is the Neuschwanstien Castle of the "Mad" King Ludwig. Disneyland was modeled after this "Fairytale Castle." We climbed many, many steps to tour this beautiful castle.

We traveled by van on our trip and enjoyed getting a close look at the countryside in both France and Germany. In Paris, we saw the Louvre, the Eiffel Tower, Notre Dam Cathedral, and had lunch at the famous Maxim's restaurant. On our way to the city of Tours, we drove through the beautiful Loire Valley, where many very pretty chateaux are located. We toured many of them and were privileged to spend the night in the elegant Chateau d' Artigny and the Chateau du Malay. The food was excellent and served so prettily.

We enjoyed a scenic drive through Normandy as we drove to Luxembourg, where we were on Aug. 5. The city is a contrast of the very old with the modern, with a distinctive French flair. They speak both French and German and use Belgian currency. While here, we had Mexican food at Chi-Chi's, and ice cream at McDonald's.

On our drive from Luxembourg to Frankfurt, we stopped at an old German town of Trier, where we saw very old Roman ruins that were very impressive.

We departed from Frankfurt on Aug. 7.

## Church Directory

**New Hope Memorial Baptist Church**  
300 NE 7th, Dimmitt

**Sunnyside Baptist Church**  
David Fletcher, Pastor  
647-5712, Sunnyside

**First United Methodist Church**  
Perry Hunsaker, Pastor  
938-2462, Hart

**La Asamblea Cristiana**  
"Full Gospel"  
Ruben Velasquez, Pastor  
400 NW 5th, Dimmitt

**First United Methodist Church**  
Vernon O'Kelly, Pastor  
647-4106 or 647-4107  
110 SW 3rd, Dimmitt

**Iglesia De Cristo**  
Pedro A. Gonzalez, Minister  
E. Lee and SE 3rd, Dimmitt

**Immaculate Conception Catholic Church**  
Norbert Choong, Pastor  
647-4219  
1001 W. Halsell, Dimmitt

**Primera Iglesia Bautista Mexicana**  
Eduardo Acevedo, Pastor  
647-4373  
301 NE 7th, Dimmitt

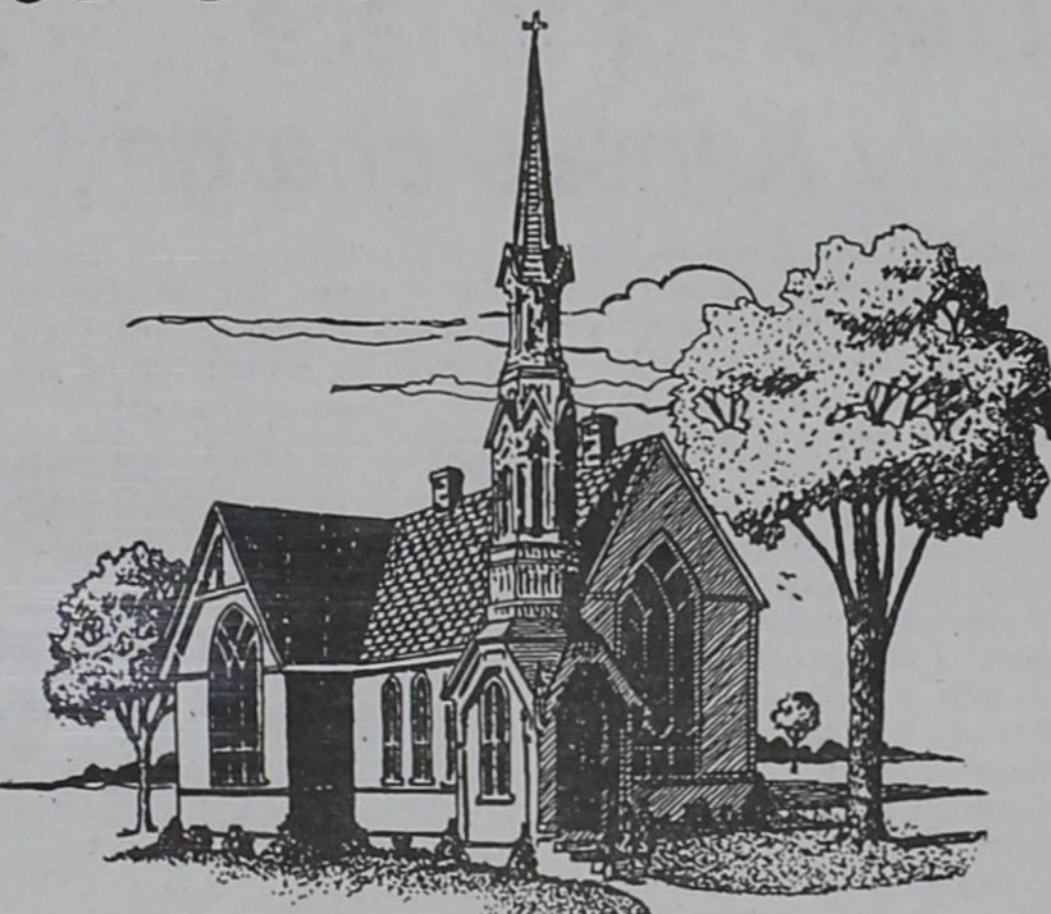

And God said, "Let the waters bring forth swarms of living creatures, and let birds fly above the earth across the firmament of the heavens." Genesis 1:20

**Church Of God Of The First Born**  
611 E Halsell, Dimmitt

**Immanuel Baptist Church**  
James Alexander, Pastor  
501 SE 3rd, Dimmitt

**Rosa De Saron Church**  
Maria Castaneda, Pastor  
647-5598  
411 NE 6th, Dimmitt

**St. John's Catholic Church**  
Norbert Choong, Pastor  
Hart

**Church Of Christ**  
Henry Baker, Minister  
647-4435  
SW 4th at Bedford, Dimmitt

**Rose Of Sharon Temple**  
407 NE 4th, Dimmitt

**First Assembly Of God**  
Claude Hendrick, Pastor  
647-5662  
300 SE 2nd, Dimmitt

**First Baptist Church**  
Paul Kenley, Pastor  
647-3115  
1201 Western Circle Drive, Dimmitt

**Lee Street Baptist Church**  
Bro. Don Webster  
647-5474  
401 SW 2nd, Dimmitt

**Church Of God Of Prophecy**  
647-3403  
309 NW 4th, Dimmitt

**First Christian Church**  
David Keller, Pastor  
647-5478  
600 Western Circle Drive, Dimmitt

**La Iglesia De Dios Del Primojenito**  
East Halsell St., Dimmitt

**Presbyterian Church**  
Edward D. Freeman, Pastor  
647-3214  
1510 Western Circle Drive, Dimmitt

**Holy Family Catholic Church**  
Neal Dee, Pastor  
945-2616, Nazareth

*This directory is sponsored by these businesses:*

American Fructose  
Associated Insurance  
Castro County News  
Castro County Pump Co.  
Dimmitt Aerial Spray  
Dimmitt Consumers

Dimmitt Equipment Co.  
Dimmitt Printing & Office Supply  
Dimmitt Ready Mix  
Farm Bureau Insurance  
Farmers Grain Co., Hart  
Flagg Fertilizer Company

Foskey Funeral Home  
Gary's Engine & Machine  
Hart Producers Co-op Gin  
Higginbotham-Bartlett Co.  
K-Bob's Steak House  
Rubie Lee Real Estate

## We Salute Our New Teachers

We'd like to extend a big Castro County welcome to these new teachers in our public schools:

### DIMMITT PUBLIC SCHOOLS

MARGARET VAIL—Bilingual kindergarten.  
SARAH McLEMORE—Eighth grade English.  
GAYLE SINGLETON—High school science.  
ELAINE RULAND—High school English and art.  
MARGIE ROGERS—First grade.  
PHILIP COX—High school biology.  
KIM HAYS—Early childhood development.  
LANNY CROW—Eighth grade athletics, physical education.  
BARBARA KENLEY—Middle school CVAE.  
KATHY WEST—High school English, business.  
SARA HILL—Middle school Gifted/Talented English.  
FRANCES DAVIS—High school computer science.  
BILL ROGERS—High school history, athletics.  
JAN SIMMONS—High school freshman English.  
TRACI HUTTON—Seventh grade reading.

### HART PUBLIC SCHOOLS

ALAN CHERRY—Athletic director, football, science.  
ADAM ARANA—high school language arts, athletics.  
JOE PERRIN—Junior high English, reading, athletics.  
JO STROEBEL—Junior high reading.  
JOE WELTS—High school science, athletics.  
VIRGINIA WELTS—High school home economics.  
DANNY WILHELM—Health, head boys' basketball coach.  
DENISE GEORGE—High school resource teacher.  
LaDAWN SCHULTE—First grade.  
DANICE WRIGHT—Fourth grade.  
TERRY DUTTON—Fifth grade.  
ALETHA JESKE—Sixth grade.  
MARTHA DEVORE—Special education.  
HELEN SINGLETON—Early childhood development.  
SOILA FIERRO—Elementary reading lab.  
MARGARET RAMBO—Elementary music.  
TOMMY STEWART—Elementary counselor.  
ELISA DIAZ—Pre-kindergarten assistant.  
NORMA CARRASCO—Sixth grade assistant.  
BECKY WILHELM—Special education assistant.

### NAZARETH PUBLIC SCHOOLS

MARK EDWARDS—History, assistant football coach.  
GLEN WALDO—Sixth grade and computer lab.  
RICK PRICE—History, head football coach.  
DENISE SKINNER—Health, PE, girls' basketball and track.  
ROGER MYERS—K-12 music and band.  
MELANIE GRUHLKEY—Kindergarten.  
CONNIE IRLBECK—First grade.  
STACY GERBER—Third grade.  
TAMMY ROBB—Fourth grade.  
TRUDY MYERS—Part-time teacher aide.

We're glad that you're part of Castro County!

## The First State Bank of Dimmitt

*We're People Like You  
Serving People Like You*

Member FDIC

# Here are the results from the county fair

**SR. CITIZEN BEST OF SHOW:**  
Marie Perrin

- BAKING—ADULT BEST OF SHOW:**  
Becky Stovall
- BARS AND SQUARES:** 1. Leesa Clark  
**CINNAMON ROLLS:** 2. Leesa Clark  
**COOKIES:** 1. Leesa Clark 2. Renise Blair  
**POUND CAKE:** 1. Becky Stovall  
**QUICK LOAF BREAD:** 1. Bessie Strickland 2. Renise Blair 3. Betty Freeman  
**YEAST BREAD:** 2. Renise Blair 3. Becky Stovall

- BAKING—YOUTH BEST OF SHOW:**  
Susan Book
- CANDY:** 1. Rachel Goldsmith  
**COOKIES:** 1. Susan Book 2. Rachel Wall

- CANNING—ADULT BEST OF SHOW:**  
Sharon Ewing
- APPLESAUCE:** 1. Lucy Pohlmeier 2. Catherine Hochstein  
**APPLE BUTTER:** 1. Bessie Strickland  
**PEACHES:** 1. Janice Bell  
**APRICOT JAM/JELLY:** 1. Dan Goldsmith 2. Catherine Hochstein  
**CHERRY JAM/JELLY:** 1. Catherine Hochstein  
**GRAPE JAM/JELLY:** 1. Barbara Davis  
**PEACH JAM/JELLY:** 1. Sharon Ewing 2. Catherine Hochstein  
**OTHER JAM/JELLY:** 2. Janice Bell  
**PICKLED BEETS:** 1. Barbara Davis 2. Bessie Strickland 3. Lucy Pohlmeier  
**BREAD AND BUTTER PICKLES:** 1. Barbara Davis  
**DILL PICKLES:** 1. Barbara Davis 2. Catherine Hochstein 3. Lucy Pohlmeier  
**HOT SAUCE:** 1. Catherine Hochstein  
**PICKLED PEACHES:** 1. Catherine Hochstein 2. Janice Bell  
**RELISH:** 1. Janice Bell  
**RELISH (CORN):** 1. Catherine Hochstein  
**OTHER PICKLES:** 2. Janice Bell-Zucchini Relish  
**GREEN BEANS:** 1. Catherine Hochstein 2. Lucy Pohlmeier 3. Leesa Clark  
**BLACKKEYED PEAS:** 1. Bessie Strickland 2. Leesa Clark 3. Deborah Goldsmith  
**POTATOES:** 1. Barbara Davis  
**SAUERKRAUT:** 1. Catherine Hochstein 2. Lucy Pohlmeier  
**TOMATOES:** 1. Catherine Hochstein  
**SAUCES:** 1. Lucy Pohlmeier 2. Bessie Strickland

- CANNING—YOUTH BEST OF SHOW:**  
Karmen Pohlmeier
- APPLESAUCE:** 1. Karmen Pohlmeier  
**PEACH JAM/JELLY:** 1. Amanda Kennedy  
**OTHER JAM/JELLY:** 1. Amanda Kennedy  
**PICKLED BEETS:** 1. Karmen Pohlmeier  
**DILL PICKLES:** 1. Karmen Pohlmeier  
**PICKLED OKRA:** 1. Karmen Pohlmeier  
**GREEN BEANS:** 1. Karmen Pohlmeier 2. Rachel Goldsmith 3. Sara Goldsmith  
**SAUERKRAUT:** 1. Karmen Pohlmeier

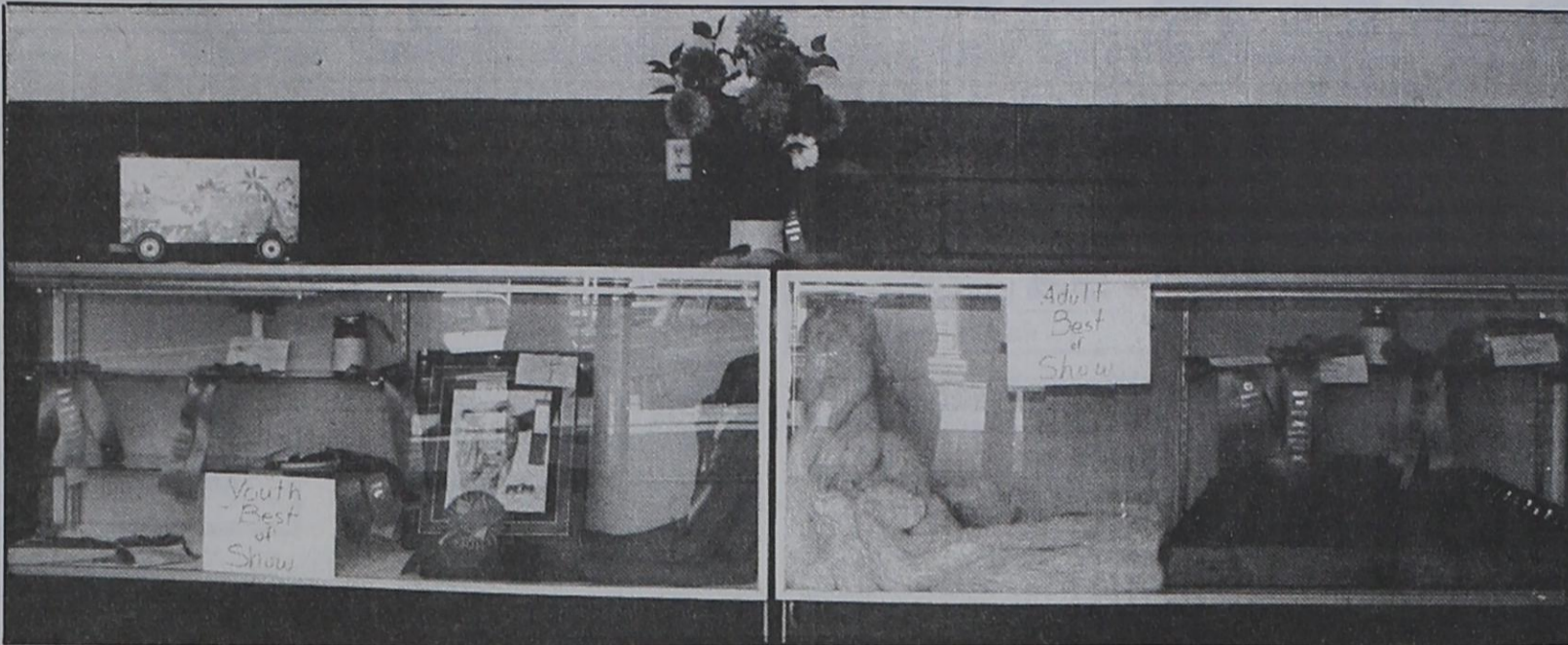

**BEST OF SHOW WINNERS**  
... The top fair exhibits were on display at the Expo Saturday.

- CANNING—SR. CITIZEN OTHER PICKLES:** 1. Rose Acker-Sweet Squash
- CLOTHING—ADULT BEST OF SHOW:**  
Reta Welch
- BLOUSE:** 1. Lucy Pohlmeier 2. Sharon Ewing  
**CHILDRENS CLOTHING:** 1. Sharon Ewing 2. Sharon Brockman  
**EVENING WEAR:** 1. Sharon Brockman  
**DRESS:** 1. Sharon Brockman 2. Leesa Clark  
**SUIT:** 1. Reta Welch  
**OTHER:** 1. Reta Welch

- CLOTHING—YOUTH BEST OF SHOW:**  
Kalina Pohlmeier
- BLOUSE:** 1. Karmen Pohlmeier 2. Lyndy Mitchell  
**CHILDRENS CLOTHING:** 1. Mitchell Brockman  
**JUMPSUIT:** 1. Susan Book  
**SHORTS:** 1. Rachel Wall 2. Melanie Book  
**SUIT:** 1. Kalina Pohlmeier  
**SKIRT:** 1. Beth Teaschner 2. Karmen Pohlmeier  
**VEST:** 1. Lyndy Mitchell  
**OTHER:** 1. Tisha Rice 2. Karmen Pohlmeier

- CLOTHING—SR. CITIZEN BLOUSE:** 1. Rose Acker  
**COORDINATES:** 1. Rose Acker  
**DRESS:** 1. Rose Acker  
**SKIRT:** 1. Rose Acker  
**OTHER:** 1. Rose Acker

- CRAFTS—ADULT BEST OF SHOW:**  
Bryce Dowell
- AFGHAN (crocheted):** 1. Catherine Hochstein 2. Jeanne Grazier  
**CALLIGRAPHY:** 1. Darrene Collins  
**COUNTED CROSS STITCH:** 1. Kim Burnam 2. Joyce Hunter 3. Ginger Scarborough  
**CREWEL EMBROIDERY:** 1. Becky Stovall  
**CROCHETED ITEM:** 1. Murl Ward 2. Catherine Hochstein 3. Leesa Clark  
**CROSS STITCH:** 2. Val Byers  
**COSTUME:** 1. Becky Stovall  
**DECORATED SHIRT:** 1. Leesa Clark  
**HOLIDAY:** 1. Ginger Scarborough  
**KNITTED SWEATER:** 1. Leesa Clark  
**LEATHER:** 1. Jackie Roberts  
**NEEDLEPOINT:** 1. Frances Frazier  
**OIL PAINTING:** 1. Darrene Collins

- OIL PAINTING (Professional):** 1. Frances Frazier  
**PASTEL:** 1. Frances Frazier  
**PENCIL DRAWING:** 1. Gayle Jones 2. Darrene Collins  
**PILLOWS:** 1. Joyce Hunter 2. Val Byers 3. Tami Griffith  
**POT HOLDER:** 1. Catherine Hochstein  
**SCHERENSCHNITTE:** 1. Renise Blair  
**TOLE PAINTING:** 1. Lynette Rials  
**WATER COLORS:** 1. Frances Frazier 2. Darrene Collins  
**WOOD:** 1. Bryce Dowell 2. Jackie Roberts 3. Lynn West  
**WREATHS:** 1. Deborah Goldsmith  
**PAINTED FABRIC:** 1. Tami Griffith

- CRAFTS—YOUTH BEST OF SHOW:**  
Hadley Fletcher
- CERAMICS:** Rachel Goldsmith  
**COUNTED CROSS STITCH:** 1. Lyndy Mitchell  
**HOLIDAY:** 1. Jeff Stofall 2. Nicole Clark  
**LEATHER:** 1. Justin Roberts  
**OIL PAINTING:** 1. Rachel Wall  
**PENCIL DRAWING:** 1. Joshua Roberts 2. Rachel Goldsmith  
**WATER COLORS:** 1. Michael Bell  
**WOOD:** 1. Joshua Roberts  
**CRAYON DRAWING:** 1. Jody Stovall 2. Jeff Stovall 3. Nicole Clark  
**PEN AND INK:** 1. Hadley Fletcher  
**OTHER:** 1. Jody Stovall

- CRAFTS—SR. CITIZEN AFGHAN (crocheted):** 1. Katy Collins  
**AFGHAN (knitted):** 1. Betty Freeman  
**KNITTED SWEATER:** 1. Betty Freeman  
**NEEDLEPOINT:** 1. Rose Acker  
**OIL PAINTING:** 1. Lucille Dollar 2. Rose Acker 3. Ed Freeman  
**TOLE PAINTING:** 1. Marie Perrin  
**PAINTED FABRIC:** 1. Marie Perrin  
**DECORATED CLOTHING:** 1. Rose Acker

- FARM AND GARDEN — ADULT BEST OF SHOW:**  
Verbie Nelson
- YELLOW CORN:** 1. Randy Morgan

- PEACHES:** 1. Verbie Nelson 2. Fran Frazier 3. Janet Mitchell  
**BELL PEPPER:** 1. Eldon Lilley 2. Randy Morgan  
**CANTALOUPE:** 1. Patti Kern 2. Catherine Hochstein  
**CUCUMBER:** 1. Randy Morgan  
**GREEN BEAN:** 1. J. O. Seale  
**OKRA:** Catherine Hochstein 2. Patti Kern 3. Mattie Seale  
**PEAS:** 1. Randy Morgan 2. J. O. Seale  
**PEPPERS:** 1. Patti Kern 2. Catherine Hochstein 3. Randy Morgan  
**PUMPKIN:** 1. Catherine Hochstein  
**SUMMER SQUASH:** 1. Randy Morgan 2. J. O. Seale  
**WATERMELON:** 1. Catherine Hochstein 2. Patti Kern  
**OTHER:** 1. Fran Frazier 2. Catherine Hochstein

- FARM AND GARDEN — YOUTH BEST OF SHOW:**  
Mitchell Brockman
- SUNFLOWER:** 1. Mitchell Brockman 2. Cody Annen  
**BELL PEPPER:** 1. Saige Annen  
**BROCCOLI:** 1. Cody Annen 2. Saige Annen  
**CANTALOUPE:** 1. Mitchell

- Brockman 2. Matthew Kern**  
**CUCUMBER:** 1. Shawn Pohlmeier 2. Bryce Pohlmeier 3. Joshua Roberts  
**GREEN BEAN:** 1. Shawn Pohlmeier  
**OKRA:** 1. Matthew Kern 2. Bryce Pohlmeier 3. Mitchell Brockman  
**PEAS:** 1. Joshua Roberts  
**PEPPERS:** 1. Mitchell Brockman 2. Shawn Pohlmeier 3. Matthew Kern  
**PUMPKIN:** 1. Joshua Roberts 2. Cody Annen  
**SUMMER SQUASH:** 1. Shawn Pohlmeier 2. Joshua Roberts 3. Bryce Pohlmeier  
**WATERMELON:** 1. Matthew Kern

- FARM AND GARDEN — SR. CITIZEN**  
**APPLES:** 1. Fred Kuntz  
**GRAPES:** 1. Fred Kuntz  
**PEACHES:** 1. Fred Kuntz 1. Katy Collins  
**PLUMS:** 1. Fred Kuntz  
**STRAWBERRIES:** 1. Rose Acker  
**CANTALOUPE:** 1. Ralph Lambright  
**SUMMER SQUASH:** 1. Rose

- Acker**  
**EGG PLANT:** 1. Rose Acker  
**WATERMELON:** 1. Ralph Lambright

- HORTICULTURE—ADULT BEST OF SHOW:**  
Mattie Seale
- FLOWER:** 1. J.O. Seale (dahlia) 2. J.O. Seale (marigold) 3. J.O. Seale (canna)  
**AFRICAN VIOLETS:** 1. Becky Stovall  
**FLORAL ARRANGEMENTS:** 1. Mattie Seale 2. J.O. Seale

- HORTICULTURE—YOUTH BEST OF SHOW:**  
Rachel Goldsmith
- FLOWER:** 1. Rachel Goldsmith 2. Rachel Wall

- PHOTOGRAPHY—ADULT BEST OF SHOW:**  
June Ewing's
- ANIMALS:** 1. Edna Ewing 2. Renise Blair  
**ANTIQUE:** 1. Deborah Goldsmith  
**BUILDINGS:** 1. June Ewing 2. Renise Blair 3. Reta Welch  
**LANDSCAPES:** 1. June Ewing 2. Deborah Goldsmith 3. Jody Watts  
**PEOPLE:** 1. Becky Stovall 2. Ricky Mitchell 3. Renise Blair  
**SEQUENCE:** 1. Renise Blair 2. Sharon Ewing  
**SPORTS:** 1. Renise Blair 2. Randy Morgan  
**STILL LIFE:** 1. Renise Blair 2. Reta Welch 3. Janet Mitchell  
**TRANSPORTATION:** 1. Reta Welch 2. Renise Blair  
**ENLARGEMENTS:** 1. Don Nelson 2. Reta Welch 3. Sharon Ewing  
**OTHER:** 1. Renise Blair

- PHOTOGRAPHY—YOUTH BEST OF SHOW:**  
Sara Goldsmith
- ANIMALS:** Sara Goldsmith  
**BUILDINGS:** 1. Rachel Wall  
**LANDSCAPES:** 1. Andrew Teaschner 2. Rachel Wall  
**PEOPLE:** 1. Sara Goldsmith  
**SPORTS:** 1. Rachel Wall  
**STILL LIFE:** 1. Rachel Wall  
**TRANSPORTATION:** 1. Rachel Wall  
**OTHER:** 1. Rachel Wall

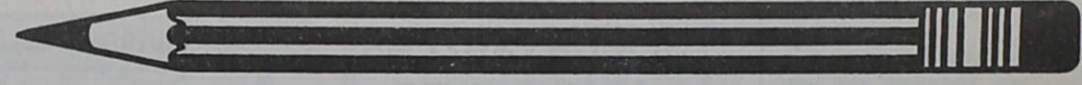

## BACK-TO-SCHOOL SAVINGS

**DR PEPPER**  
12 CAN PACK  
**\$3.19**

**NEW FREEDOM ASSORTED PADS**  
PREPRICED \$3.59  
**\$3.39**

**NEW FREEDOM ANYDAY PANTYLINERS**  
PREPRICED \$1.59  
**\$1.39**

**FISHER BOY FISH STICKS**.....8 OZ. PKG. **79¢**

**ASSORTED GERBER JUICE**.....6 PK. **\$1.39**

**ASSORTED, 4 OZ. BOTTLE GERBER JUICE**.....4 FOR **\$1.00**

**MORRISON, CORN BREAD MIX, 6 OZ. PKG.** **\$1.00**

**CORN KITS**.....6 OZ. 3 FOR **\$1.00**

**VLASTIC PITTED MEDIUM RIPE OLIVES**.....6 OZ. **99¢**

**LUNCHEON MEAT SPAM**.....12 OZ. **\$1.69**

**RHODES TEXAS DINNER ROLLS**.....3 LB. BAG **\$1.79**

**SHURFINE CATSUP**.....32 OZ. **79¢**

**NABISCO ASSORTED OREO COOKIES**  
20 OZ. PKG.  
**\$2.39**

# THRIFTWAY

**AT AFFILIATED FOODS INC.**  
MEMBER STORE  
**SPECIALS GOOD AUGUST 23-29, 1990**

**WE ACCEPT FOOD STAMPS...WE RESERVE THE RIGHT TO LIMIT**

**DOUBLE COUPONS 7 DAYS A WEEK!**  
Thriftway will double the value of manufacturers coupons 50¢ or less. This excludes coupons from other retailers, excludes cigarettes and tobacco coupons. The refund is not to exceed the value of the product.



Central Plains Psychiatric Center

**VICTOR A. GUTIERREZ, M.D.**

Victor A. Gutierrez, M.D., is pleased to announce the opening of his private practice in psychiatry.

Dr. Gutierrez offers a variety of services including pharmacotherapy, marital therapy, crisis intervention, psychological testing, relaxation therapy, group therapy, alcohol and drug abuse treatment, outpatient services, and many other psychiatric services.

For an appointment with Dr. Gutierrez, call 296-5327, 8 a.m. to 5 p.m., through Friday.

2601 Dimmitt Road Plainview, TX 79072 806-296-5327

Central Plains Psychiatric Center

**West awarded 'Best of Show'**

Following are the results of the quilt show which was judged Friday morning at the fair.

**BEST OF SHOW:** Twila West  
**JUDGES AWARD:** Teresa Parsons

**LARGE PIECED QUILTS:** 1. Twila West 2. H.M. Morrison 3. Renise Blair  
**SMALL PIECED QUILTS:** 1. Renise Blair 2. Twila West 3. H.M. Morrison  
**SMALL APPLIQUE QUILTS:** 2. H.M. Morrison  
**LARGE COMBINATION QUILTS:** 1. H.M. Morrison  
**SMALL COMBINATION QUILTS:** 1. H.M. Morrison  
**LARGE QUILT TOP:** 1. H.M. Morrison 2. Mae Hargrove  
**LARGE MACHINE QUILTED:** 1. Darrene Collins 2. Katy Collins  
**ANTIQU (pre-1940):** 1. Dorothy Mayfield 2. Teresa Parsons 3. Ocie Bolton



# CLASSIFIEDS



## The Castro County News

647-3123 PO Box 67, Dimmitt, Texas 79027  
Published each Thursday in Dimmitt, Texas, by the News Publishing Co., 108 W. Bedford. Second Class Postage Paid at Dimmitt, Texas. Publication Number 092980.



Member of the Texas Press Association, West Texas Press Association, Panhandle Press Association and National Newspaper Association.

### DEADLINES

Display and Classified Advertising ..... Tuesday Noon  
Agriculture, Business & Industry News ..... 10 a.m. Monday  
Sports, Society and Church News ..... Monday Noon  
Community Correspondence ..... Monday Noon  
Personal Items ..... 5 p.m. Monday  
General News, City and County ..... Tuesday Noon

### 1—Real Estate, Homes & Land

**PUBLISHER'S NOTICE**  
All real estate advertised in this newspaper is subject to the Federal Fair Housing Act of 1968 which makes it illegal to advertise "any preference, limitation or discrimination based on race, color, religion, sex or national origin, or any intention to make any such preference, limitation or discrimination."  
This newspaper will not knowingly accept any advertising or real estate advertising for real estate which is in violation of the law. Our readers are informed that the dwellings advertised in this newspaper are available on an equal opportunity basis.

**BRICK, TWO BEDROOM**, two bath house on 1-1/2 acres near Hereford. Covered patio and two-car garage. Extra acreage available. Country living, close to downtown. \$38,500. Call 647-4674 early or late. 1-10-tfc

**FOR SALE** Three bedroom house. Hart, two full baths, two-car garage, double lot. Includes small rent house on property. Will consider lease-purchase. 938-2206 or 647-4674. 1-9-tfc

**FOR SALE BY OWNER:** 1008 Oak—Three bedroom, 1-3/4 baths, large den with fireplace, double-car garage, refrigerated air and sprinkler system. By appointment only. 647-4383. 1-8-tfc

### Jay Cross Investments

**GREAT LOCATION:** Sprinkler system, all kinds of built-ins, fireplace, tons of storage. This one is a real beauty. \$65,000.

**NEW LISTING:** Priced to sell! This home has 3 bedrooms, large bathroom, lots of storage, carpet and much more, located in northwest Dimmitt. Approximately \$3,000 and good credit will get you in this one.

**TEACHER'S SPECIAL:** This excellent location and good neighbors will please you. This large brick home offers plenty of room with three bedrooms, 1-3/4 baths and double-car garage. All for \$53,000.

**COUNTRY HOME:** Great beginner home! Three bedrooms, one bath. Special financing available.

Jerry Cartwright, Broker/Owner  
Patti Cartwright, Owner  
810 W. Halsell 647-2604

**LARGE two bedrooms**, 1-3/4 baths, one car garage, rareth. Excellent location. Lots of built-ins and two living areas. Great buy at \$37,000.

**COUNTRY HOME** on highway. Four bedrooms, two baths, large shop. Excellent location. \$55,000.

**OWNER WILL PAY CLOSING.** Three bedrooms, 1-3/4 baths, screened patio. Good price at \$35,000.

**NEW ON MARKET.** Beautiful 4 bedroom, two bath in excellent neighborhood. Many extras make this a very desirable home at \$76,000.

**WE HAVE** several good properties in contract. We are getting low on listings. Give us a call if you have a house, commercial property, farm or ranch you need to sell.

### GEORGE REAL ESTATE

S. Hwy. 385 647-4174  
Mary Lou Schmucker  
Office Mgr. and Sales  
945-2679  
Reta Welch.....647-5647  
Jimmie R. George, Broker

### 1—Real Estate, Homes & Land

**LAND FOR SALE:** 484.6 acres irrigated farm land located two miles north and three miles east of Hart, Texas in Castro County, Texas. House, barn, four wells, tailwater return pump, underground tile. For more information, call 293-3635 and ask for Brian Pohlmeier. 1-19-2tc

**NICE**, three bedrooms, two baths, new paint. Owner needs to sell this one!

**SMALL FEEDLOT** (1000 head) with office and scales. Includes grain storage and dryer, all on 132 acre irrigated farm with house and barn, on pavement.

**NEW LISTING—Three** bedrooms, two baths, new paint, large metal storage house. Ready for new owner.

**TWO BEDROOMS**, two baths, fenced yard. Owner financed.

**NEAT LITTLE** two bedroom, one bath with excellent concrete storm cellar. Owner financed.

**15 UNIT MOTEL—Terms**, remodeled and owner is ready to sell.

**NICE**, four bedroom, two bath brick home. All of the extras plus good location.

### GREGORY REAL ESTATE

BILL GREGORY, Broker  
Phone 647-3347 or 647-5421  
505 SE 3rd, Dimmitt

### 2—For Rent

**504 SW SIXTH**, \$265; 805 SW Fifth, \$235; Both two bedroom. 1-354-9771, between 7 and 8 a.m. 2-12-tfc

**FOR RENT**, two-bedroom, fenced yard. 647-3366. 2-19-1tc

**FOR RENT:** Two bedroom house. Call 647-5559. 2-14-tfc

**STORAGE SPACES** for rent. Call 647-3447 or 647-2577. 2-1-tfc

### DIMMITT SENIOR CITIZENS APARTMENTS

622 N.W. 5th  
"Now Taking Applications"  
Phase II Occupancy  
Call 647-2638  
S&S Properties Equal Opportunity Housing

**TWO BEDROOM** apartment for rent. Also, one trailer space. Both at 409 W. Jones. 647-2456. 2-13-tfc

**RUSKIN APARTMENTS** for rent. Call after 6 p.m., 647-2229. 2-6-tfc

**NAZARETH TRAILER PARK—Trailer** spaces for rent. Water and sewer paid. 945-2501. 2-18-tfc

**TWO BEDROOM HOUSE** for rent. Call 647-2339. 2-43-tfc

**FOR RENT:** Nice, three bedroom apartment in Hart. 938-2411. 2-1-tfc

**MOBILE HOME LOTS** for rent. Water furnished. Call 647-4409. 2-1-tfc

**ONE AND TWO BEDROOM** apartments and a three bedroom house for rent. 114 NW 12th. 647-3318. 2-11-tfc

### Stafford Apartments

One and two bedroom, furnished or unfurnished. Privacy yard, microwave, dishwasher. Call 647-2631 or 647-3696.

### 1—Real Estate, Homes & Land

### 2—For Rent

1-800-752-8865  
**RYDER TRUCK RENTAL, INC.**  
For Rate Information

### 3—For Sale, Misc.

**GARAGE SALE** 210 Front Street, Friday and Saturday, Aug. 24-25, 9 till 6. 3-19-1tc

**REDUCE:** Burn off fat while you sleep. Take OPAL. Available at Parson's Drug. 3-17-7tp

**FOR SALE:** Two refer cars, wheels and all, \$1,000 each, located on tracks behind Grace Chemical. 293-7542. 3-13-tfc.

**DISCONTINUED PATTERNS** in Oneida stainless, Fostoria glassware and Franciscan dinnerware. 1/2 price and less. Parsons Drug. 647-3392. 3-1-tfc

### 4—Household Goods

**RENT TO OWN**  
NEW TV'S, VCR'S & APPLIANCES  
No credit checks.  
KITTRELL ELECTRONICS  
647-2197 Dimmitt

### 5—Farm Equipment

**FOR SALE** 1980 Model John Deere Combine 8820, with 8-row corn head and 24' platform. (602) 384-3651. 5-19-2tp

**WE REPAIR** all makes of fence chargers. Dimmitt Consumers Electric Shop, NE Third and Etter. 5-1-tfc

**END OF SEASON** special. Rebuilt 446 IH irrigation engine 3300. Hi-Way Garage in Hart, 938-2169. 5-17-tfc

### 5A—Farm Produce

**PICK YOUR OWN** yellow freestone peaches. Ready-picked green beans. Call for availability. Maxwell Orchards, Dimmitt, Texas. 8-8 daily, closed Mondays. (806) 647-4613. 5A-19-1tc

### 6—Automotive

**1976 MERCURY** 4-door sedan, 27,000 actual miles. 647-3250. 6-19-tfc

**FOR SALE** 1982 Chrysler New Yorker 3th Ave. Extra clean, good tires. 647-5250. 6-19-tfc

**FOR SALE** 1974 Mercury, good shape for \$900; and 1978 Cougar, also good condition, for \$1,500. Call 647-5241. 6-19-2tp

**FOR SALE:** 1975 Honda Goldwing, full dress, running boards, heel and toe shifter, AM-FM with C.B. and helmet. 647-3161 days; 647-4573 nights. Ask for Lloyd. 6-8-tfc

### 8—Services

**CHILD CARE IN MY HOME** available for new school year. During the day. Drop-ins welcome. Call Lisa at 945-2648. 8-18-2tc

**SHEFFY'S TV & APPLIANCE SERVICE**  
Certified repair on most major brands  
647-2556  
214 E. Bedford Scott Sheffy

**CALL ME FOR ALL YOUR** carpenter needs, large or small jobs, paneling or roofing, inside or outside work. Nathan Pevehouse, 938-2411. 8-1-tfc

**WILL DO SEWING**, alterations in my home. Bonnie Kenworthy Davis, 647-3114. 8-44-tfc

**ROOFING SYSTEMS—**For quality hail-resistant roofing, call Robert Duke, 647-5517 or 647-2479. 8-46-tfc

**YARD CLEANING**, moving, rototilling. Call Sam Raper Jr., 647-4415. 8-1-tfc

### 2—For Rent

**Azteca Complex APARTMENTS**  
910 E. Jones  
★ NOW LEASING ★  
1, 2 or 3 Bedrooms  
We have Rent Assistance for qualified tenants (agricultural workers)

For more information, call (806) 647-3406 Night 647-2677 Miquel Velasquez, Manager  
Equal Opportunity Housing

### 8—Services

**BARB'S K-9 GROOMING.** Call 1-935-3711 or 1-995-3301, Tulia. 8-3-tfc

**HENDERSON TV & APPLIANCE** sells and services televisions, satellites and appliances. 647-4342. 8-1-tfc

### CUSTOM SILAGE HARVESTING

Call Wes Myers at 1-316-376-4510 or 1-316-376-4250 or Marvin Elder at 1-316-376-4656

**AMARILLO-AREA PREGNANCY** Crisis Center Hotline. Call collect, 0-354-2244. Also, Methodist Mission Home, 24 hours, toll-free, 1-800-842-5433. 8-4-tfc

**FOR ALL YOUR CARPENTER NEEDS**, for home repairs and remodeling, call James Cobb, 647-5320. 8-4-tfc

### Frank Rossi Paper Hanging

1-995-3030 Tulia, Texas  
WILL WEDEAT and mow yards and till gardens with 8HP Troybilt. Call 647-5157. 8-46-tfc

**CUSTOM SWATHING**, round baling and hauling. Call Don Kimbrell, 1-764-3328. 8-14-tfc

**WILHELM CUSTOM FARMING:** Laverne, 647-5425; Henry, 945-2518. Subsoil and conventional plowing, spraying. 8-22-tfc

### ROUND-UP APPLICATION

Pipe-wick mounted on hi-boy. Row crops, CRP and vol. com. 30" or 40" rows.  
Roy O'Brian, 265-3247

### ARTISAN FENCE GENE SANDERS

352-4188 ANY TYPE FENCE & REPAIRS

### 9—Help Wanted

**PART-TIME JOB—**Demonstrate toys, gifts, home decor from now until Christmas. Free kit, free supplies, free training. No collecting or delivering. Details without obligation. Call 647-5269. 9-18-4tc

**HELP WANTED:** Steere Tank Lines, Inc., of Dimmitt now accepting applications for full time and part-time truck drivers. One year experience in the last 3 years necessary. Must be at least 21 years old. Please apply in person. Equal Opportunity Employer. 9-19-3tc

**THE CITY OF DIMMITT** is accepting application for a garbage truck driver. You must have a Commercial Drivers License (CDL) and be 18 years old or older. All applications must be in by Aug. 31, 1990. The City of Dimmitt is an Equal Opportunity Employer. 9-19-1tc

**TAKING APPLICATIONS** for payroll clerk/computer operator. Bookkeeping experience preferred. Application deadline is Sept. 5. Brown, Graham & Company, 308 W. Bedford, Dimmitt, 647-3136. 9-19-2tc

### 10—Wanted, Misc.

**I WOULD LIKE TO BUY** your used gold jewelry—broken, worn out or otherwise. Call 647-3250, evenings. 10-1-tfc

### 11—Livestock, Pets

**STARTING** and finishing horses, excellent trainers. Call Harvey Kidd or Bobby Holland. 647-3231. 11-19-tfc

**CUSTOM CATTLE** processing, professional experience, reasonable rates. Sandra and Harvey Kidd. 647-3231. 11-19-tfc

### 2—For Rent

## We can help you find your new home!

RUBIE L. LEE, Broker 647-2427, Residence  
KENT LINDSEY, Salesperson 647-5772, Residence  
TERESA LINDSEY, Salesperson 647-5772, Residence  
GWEN BRYANT, Salesperson 647-5509, Residence

# Rubie L. Lee

INDEPENDENT REAL ESTATE BROKER  
647-2326, Office 106 NW 3rd, Dimmitt

### 12—Notices

**ALCOHOLICS ANONYMOUS** 647-4594. 12-17-4tc

### 13—Lost & Found

**LOST:** Blue-rimmed sun shades at Combast's town hall meeting Wednesday, Aug. 15. Call 647-4206. 13-19-1tc

**FOUND:** One video game. 647-3535. 13-18-tfx

### 14—Card Of Thanks

**CARD OF THANKS**  
Your kind expression of sympathy is gratefully acknowledged and deeply appreciated.  
THE FAMILY OF ODIE MUNDELL  
14-19-1tc

**CARD OF THANKS**  
Thanks to everyone who made the 1990 Fair and Harvest Days Celebration a success. Those who set up the fair, took it down, all that entered exhibits, had booths, those who gave of their time and energy months before the fair working and planning.  
A special thanks to the county commissioners for making needed improvements to the quonset barn and getting actively involved in the events. We appreciated the ministers who served as greeters on Friday and to the Extension Homemakers for their hospitality.  
It took individuals, groups and businesses to make it all happen: Energas donated financially, SPS hung the street banner and Dimmitt Ready Mix provided sand for games.  
The Lions Club, as always, did an outstanding job of organizing the parade, and Terri Todd of KDHN, along with Bill Conyers, for announcing the parade. The Rotary Club, Kiwanis Club, W.J. Hill, Merrick Pat Foods, Danny Newton, Flex Lust, and Danny Rice, Volunteer Firemen, Museum Association, Booster Club and the Old Settlers Association for organizing events.  
Flatland Bluegrass Band, ICC Clown Ministry, Bill Sava, Terri Louder, Herb Mayfield, and Cowboy Poets Society for entertainment.  
Our thanks to each of you. We needed you and have hopes for a huge centennial celebration in 1991. The fair will be Aug. 15-17, 1991.  
DOROTHY MAYFIELD  
Castro County Fair Chairman  
DELORES HELLER  
Executive Director  
Dimmitt Chamber of Commerce  
14-19-1tc

**LEGAL NOTICE**  
Castro County Commissioners Court will accept bids until 10:00 a.m., August 27, 1990 for approximately 3/4 miles of seal coating on Rodeo Road located in Dimmitt, Texas. Information may be obtained from Judge Polly Simpson, 806/647-4451. Bids will be accepted at the County Judge's Office and will be opened August 27, 1990 at regular meeting of Commissioners' Court.  
Castro County reserves the right to reject any or all bids and to waive formalities.  
MRS. M.L. SIMPSON, JR.  
County Judge  
Castro County, Texas  
15-19-1tc

### 15—Legal Notices

**LEGAL NOTICE**  
No. PR 2004

**THE ESTATE OF MYRRAH KATE LOVE, DECEASED**

**IN THE COUNTY COURT OF CASTRO COUNTY, TEXAS**

**NOTICE TO ALL PERSONS HAVING CLAIMS AGAINST THE ESTATE OF MYRRAH KATE LOVE, DECEASED**  
Notice is hereby given that original Letters Testamentary upon the Estate of MYRRAH KATE LOVE, Deceased, were issued to us, the undersigned, on the 20th day of August, 1990, in the proceedings indicated below our signatures hereto, which proceedings are still pending, and that we now hold such Letters. All persons having claims against said estate, which is being administered in the County Court above named, are required to present the same to us at the address below, given before suit upon same are barred by the general statute of limitation, before such estate is closed, and within the time prescribed by law.  
Our residence and mailing address is:  
Mary Jo Brown  
J.R. Brown  
1603 Sunset Circle  
Dimmitt, Texas 79027  
MARY JO BROWN  
J.R. BROWN  
Independent Executors of the Estate of Myrrah Kate Love, Deceased  
15-19-1tc

**LEGAL NOTICE**  
Castro County Commissioners Court will accept bids until 10:00 a.m., August 27, 1990 for approximately 3/4 miles of seal coating on Rodeo Road located in Dimmitt, Texas. Information may be obtained from Judge Polly Simpson, 806/647-4451. Bids will be accepted at the County Judge's Office and will be opened August 27, 1990 at regular meeting of Commissioners' Court.  
Castro County reserves the right to reject any or all bids and to waive formalities.  
MRS. M.L. SIMPSON, JR.  
County Judge  
Castro County, Texas  
15-19-1tc

### 8—Services

1-hour photo service  
Sheffy's Western & Casual Wear  
118 SE 2nd, Dimmitt

### Bobcat Band to sponsor car wash

The Dimmitt Bobcat Band will have a car wash this Saturday from 9:30 to 4 p.m. at the Pizza Hut parking lot.  
Cars will be charged \$5 and pick-ups, vans and suburbans will be cost \$8. There will be an additional charge of \$2 if the vehicle is very muddy.  
Proceeds will go towards the band trip in the spring.  
The band held their annual back to school hamburger cookout on Monday and marched in the Harvest Days Parade Saturday.  
The band will play during the "Meet the Bobcats" on Saturday at 6 p.m. at the high school football field.

A fine quality Persian rug may contain as many as one million knots in every three square feet.

# Nazareth

By Virgie Gerber, 945-2669

Most of the farmers received some amounts of rain this week which was so very much needed and appreciated. This has been the driest year we have had in a long time, so we thank God for the rain He has sent.

Mass of Christian burial was read last Wednesday morning for Cecilia Annen, 84, in Holy Family Church with Rev. Neal Dee officiating. Burial as in Holy Family Cemetery.

Mrs. Raymond Annen was a lifelong resident of Nazareth. Survivors include her husband; three daughters, Rubye Mae Hubbard of Ft. Worth, Gladys Gipson of Roswell, N.M., and Faye Spencer of Amarillo; a son, Claude of Nazareth; 11 grandchildren; and six great-grandchildren.

Saturday night, Alyssa Braddock, infant daughter of Cecil and Lenora Braddock, was baptized at Holy Family Catholic Church. She was born July 31. Her grandparents are Vincent and Louise Braddock and Arnold and Catherine Huseman. Great-grandmother was Helen Backus. Congratulations to the parents and her three other sisters.

Holy Family Catholic Church

was the place for a very impressive wedding of Billy and Brenda Huseman. Rev. Neal Dee performed the ceremony. A delicious meal and dance was enjoyed by family and friends.

Construction has begun on the roofs of the Holy Family Catholic Church, the pastors home and the Convent buildings. They look nice.

Tony and Angela Acker accompanied Lynn, Nancy and Ryan to Corpus Christi where Lynn will be an outpatient taking physical therapy.

Hazel Wilhelm is recuperating in the Veterines Administration Hospital recovering from surgery.

Bill Klein is also in the VA Hospital recovering from surgery. We hope that this will be the last operation, as this is one of many he has had on his leg.

Wayne Ehly is in Amarillo at the Bivins Hospital for physical therapy. He is doing much better and is able to do more as each therapy session is completed.

Good luck to the Nazareth boy's and girl's who have left or are leaving this next week for college.

Patricia Kern, Michael Kern and

Theresa Long, with her three children, were home over the weekend to visit their families and to attend the Wilhelm reunion. Also visiting was the Vic Kern family and the Dwayne Curio family. After visiting and attending the reunion, Vic's family along with Jerry Kern's family went to Dallas to visit the Long Vo family. While there they went to Wet and Wild Water Park, Six Flags and the Wild Life Safari.

Gordon and Bonita Golder of Big Rapids, Mich., and Dolores Geisler of Modesto, Calif., came to visit their brother, Bud Kern for a few days. They also attended the Wilhelm reunion. Bonita used to teach school at Nazareth.

Guests at the Lavern and Ronnie Wilhelm home this past week were Frank and Theresa Maenner, Virginia Mousel, Rose Mary Holschuh and Marcie Maenner. These were Josephine (Wilhelm) Maenner's children. They were here for the Wilhelm reunion.

Guests at C.B. Wilhelm's home this week were Urban and Micky Drilling, first cousins of his mother Cecilia Wilhelm. They were from Cresco, Iowa.

Dennis and Pattie Kern just came home from a vacation with their children, Matthew and Aaron. They

visited the Black Hills, Mount Rushmore and many sights in Nebraska, Wyoming, Kansas, Colorado and New Mexico. They brought a big cooler of fish home from their fishing in Colorado and New Mexico.

Approximately 175 Hochsteins enjoyed the Frank Hochstein reunion held at Constance, Neb., on Aug. 12.

Those attending include Brigetta and Ricky Dobmeier; Allan and Stephane Dobmeier and children; Junior and Catherine Hochstein, Mary Jeanne, John, Randy, Bobbie and Bill; Sharon Brockman and children; Dennis and Patti Kern and boys; Carol Kern and children; and May Hochstein, all from Nazareth.

Larry and Paige Hochstein and girls of Amarillo; Jimmy Hochstein of Hart; and Joe and Angela Hochstein and daughter of Dimmitt were there also.

Also attending were Geraldine Eckert of San Antonio; Connie and Bob Davis of Houston; Jerry Aberant and boys of Dallas; Judy and David Irlbeck, Elaine and son, Gail and her husband, Susie Schulte, and Glen Dobmeier, all of the Austin area.

The reunion began with a mass, followed by dinner. The afternoon was spent visiting, looking at pic-

tures and playing softball, horse-shoes, volleyball and cards.

The Nazareth bunch played the others in softball and won. People came from New Mexico, Kansas, Texas, South Dakota, Nebraska and Canada.

Rose Birkenfeld recently returned from Dallas where she visited with her sister and relative from Holland, Jean Neal Plug. After enjoying time visiting with them, she spent a couple of days in Ft. Worth with T.B. Cotters.

**HAIL SEASON IS HERE**



**SAVE MONEY ON YOUR CARPORT, PATIO COVER OR RV COVER**

**HOW?**

- BUY DIRECT FROM FACTORY
- LOW PAYMENTS (\$25.00 per month for single)
- FREE ESTIMATES
- TOLL FREE CALLS TO FACTORY

**EB-TX** P.O. DRAWER 369 PLAINVIEW, TEXAS 79073-0369  
TOLL FREE 1-800-762-3699  
PLAINVIEW NO. 806-293-9526



**Now Open**

## Grandma's Kitchen

at the Red-X Travel Center

- \* Texas-size Breakfasts
- \* Burgers (Regular and Jumbo)
- \* Barbecue Sandwiches
- \* Chicken Strips
- \* Fried Catfish
- \* Steak Fingers
- \* French Fries
- \* Curly Fries
- \* Fried Mushrooms
- \* Onion Rings

"Fill up while you're filling up!"

## Red-X Travel Center

320 S. Broadway 647-4510

# Sunnyside

By Teeny Bowden, 647-5703

Beneficial rains have been recorded this week, including .65 recorded for Tuesday in two different showers, .30 recorded Wednesday morning, 1 inch recorded Thursday afternoon and evening, .05 inch Friday night and .05 Saturday night.

Betty Rose Louder had eye surgery in Plainview Thursday but was not hospitalized. Genevieve Westmoreland of Littlefield spent the day with her and Alton.

Dr. Floyd Bradley of Plainview, Area Missionary, spoke to the church Wednesday night concerning the Southern Baptist Convention issues. Sunday night, Teeny brought to the study group the issues and dangers of the Fundamentalists and their participation in the new Reconstruction movement, and some of the leaders' involvement with a conservative coalition, the Council on the National Policy.

Leona Blanton flew from Albuquerque, N.M. to Lubbock last Saturday and drove on to Sunnyside last Sunday for the week. Ronnie

still cannot feed himself or do anything for himself. He was in isolation for two weeks recently. Linda has neuropathy, a degenerative nerve disease, little known or understood. It is still confined to her foot. Leona flew back to Albuquerque Sunday.

Don Milliken of Wolforth was dismissed from Highland Hospital in Lubbock Thursday. James and Joan Norrell spent much time with him in the hospital, and stayed Thursday and Thursday night with him and Mrs. Milliken. He is doing fine now.

Justin and Tracy Damron flew to Houston recently and visited a few days with their aunt and uncle, Mary and Ken Lupo.

Judy, Justin and Tracy went to Daingerfield and visited a few days with her parents, returning home Aug. 14.

Bob and Cindy Clatt, Jasmyne, Tyler and Chase of Richardson arrived Saturday night to spend a week with her grandparents, Embree Roy and Willie Mae Sadler. Monday, Gregory Sadler brought

Amy Sadler to spend the week with them. He spent the day. Dr. Myles Sadler of Lubbock came for Amy Sunday afternoon.

Visitors in the Sunday morning services included Bob and Cindy Clatt and children, and Amy Sadler of Lubbock. Amy brought the special music. The Clatt family also visited in the evening worship service.

Naomi Brown of Hale Center called Teeny Bowden Saturday afternoon for a rare visit. She was lonesome for Sunnyside and needed to talk to someone who would understand the problems associated with dialysis. Cliff is doing pretty well. He is still working. They are still active in the church, but are slowing down on most things. Their kids are doing okay. Lynn is not married yet. She said to tell everyone "hello" for them.

Stacy Norman, Jeremy and Joshua spent Wednesday night in Muleshoe with Laura and Nick Hurtado and children. She visited with them again Saturday afternoon.

Madge Robb worked on pictures Monday afternoon for the Vol. II History Book, while Teeny Bowden worked on the Ranching Heritage section of the book. Emma Jean King worked on pictures and proof reading Tuesday afternoon. For six hours Thursday afternoon, Stacy Norman typed on the computer several short articles and the beginning of the Ranching Heritage, while Teeny took the POW Chapel Restoration and Pre-History sections to Eddie Guffee in Plainview to proof read and do some picture captions. She visited for a while with him and Patti. Clara Vick had dinner with Teeny Sunday and they worked on pictures. Clara took them home with her to do captions as she has time.

Thursday, Emma Jean King entertained her grandsons, Lance and Lincoln King of Earth, and Brien Sutton of El Paso. She took Brien to Hobbs, N.M. Friday to meet his mother, Betty Sutton. Margaret Williams of Eunice met them there for a short visit.

Rev. David and Debra Fletcher, Haley and Harmony took Hadley to Borger Thursday to the allergy doctor and for a treatment on his neck.

The doctor and David are cousins.

The Fletchers went to Lubbock Friday night to the International Crusades Banquet for those making missions trips overseas.

Haley Fletcher celebrated her 12th birthday in Plainview Saturday morning at Family Fun Park with her mother, Hadley and Harmony, and Darla Ford, Tate, Taos and Trey of Plainview.

**WANTED !!**

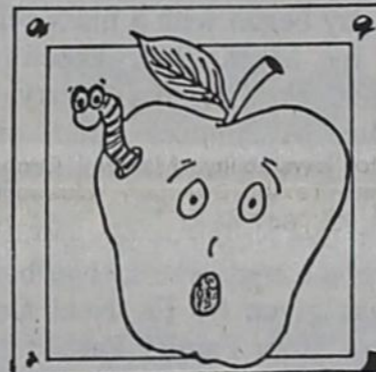

**FOR PIE**

**PARTNERS IN EDUCATION**

**CALL:**

- Belinda Hill.....647-5725
- Cenci Hardee.....647-5162
- Deborah Goldsmith....647-2324
- Martha Jo Hyman.....647-2255
- Debbie Annen.....647-4566

**APOLLO ELECTRIC**

RESIDENTIAL \* COMMERCIAL \* INDUSTRIAL  
Experience is not always the answer, unless knowledge is truly gained; and then only with diversity !!

AT LEAST 20% OFF ON WRITTEN ESTIMATES  
New construction, Remodels, Stores, Offices, Ceiling fans, Switches, Computer cable & Dedicated circuit installations, Motors & Controls, Agricultural installations, Telephone outlets, Lighting, Wall outlets.

AT LAST AN ! AFFORDABLE ! ALTERNATIVE  
For more information call:

LICENSED **647-2370** BONDED

**310 Wheat St. Dimmitt, Texas**

### Weight Loss

**Why do conventional diets fail?**

1. They depend entirely on will power or conscious decisions alone.
2. They deal with symptom only (weight) ignoring the causation.
3. The old eating habits and desires remain.

**Why is hypnotherapy effective?**

1. Does not rely on costly or restrictive diets or medication.
2. Reprograms strong powerful desires in the subconscious.
3. Omits negative subconscious emotions and behavior.
4. Builds powerful self esteem and confidence.
5. Dissolves and releases daily stress and tensions.
6. Utilizes the most powerful part of the mind (the subconscious) that normally goes untapped in all other forms of treatment.

### Hypnotherapy?

Hypnotherapy in treatment of overweight is not new. It has been safely and effectively used by physicians, analysts and therapists for many years.

Hypnosis is not a mystical magic wand, but rather a scientific procedure that has positive results in medical and clinical research and practice.

Therapist Donny Harland is certified in Analytical, Forensic, and Therapeutic Hypnosis, and a member of the International Society of Professional Hypnosis.

Check with your physician and see if hypnotherapy may be for you, and then experience the difference.

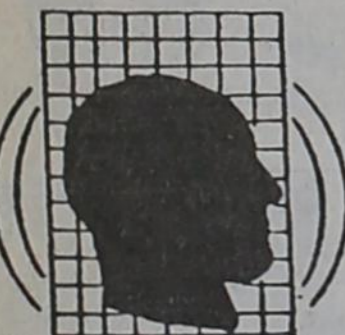

**Therapeutic Self Help & Hypnosis Center**  
Donny Harland  
Therapist

For more information or free consultation call  
995-3101  
995-2827  
Tulia, Texas

## End of Summer CLEARANCE





**We're selling 'em at DEALER INVOICE while they last!**

## J&H Equipment Co.

S. Hwy. 385, Dimmitt 647-3324

# People

## Couple united in a double ring ceremony



Mrs. David Jay Arterburn  
...nee Lori Suzanne Axe

Lori Suzanne Axe and David Jay Arterburn exchanged vows July 28 in a double-ring ceremony at the First Baptist Church in Lubbock with the groom's brother, Donny Arterburn of Waco, officiating.

The bride is daughter of Dr. and Mrs. Jim A. Axe of Lubbock and the granddaughter of Fern Dickey of Dimmitt and Mr. and Mrs. H.L. Axe of Vega. Parents of the groom are Mr. and Mrs. Junior Arterburn of Lubbock.

Larry Landusky, pianist played

Friends as the mothers and grandmothers were seated. He played *To God Be the Glory* as the bridesmaids, ring bearer and flowergirls came down the aisle. He accompanied soloist, David Gaschen, as he sang *The Wedding Song* and *The Lord's Prayer*. Mike and Barbara Hardy sang two duets, *Here We Are and Only God Could Love You More*. Dick Tolley played *Trumpet Voluntary* on the trumpet as the bride walked down the aisle. He also played *Trumpet Tune* for the

recessional.

The bride, given in marriage by her father, wore a gown of white French lace and sequins. The neckline was crowned with a high collar and the sleeves were a bishop design. The bodice was encrusted with pearls and jewels, and the waistline was adorned with pearls in a swirl pattern. The skirt was a design of flowering French lace and sequins. The back of the dress was showered with a long runner of buttons. The train was court length covered with lace and sequins.

Serving as maid of honor was Heather Axe of Lubbock, sister of the bride. Bridesmaids were Debbie Keneda of Lubbock, Amy Knight of Brownfield, Mary Floyd of Lubbock, Shawndi White of Lubbock, Linda Bulkley of San Antonio, Diana Mullins of Bryan, Jan Thetford of Lubbock and Samantha McKay of Lubbock. The bridesmaids wore tea length dresses of turquoise taffeta.

The best man was Larry Toon of Dallas. Groomsmen included Bret Dixon of Lubbock, Steve Hill of Slaton, John Floyd of Lubbock, Alan Hatch of Lubbock, Tim Leslie of Lubbock, Dee Law of Lubbock, Charlton Northington of Lubbock

and Milt Brownfield of Lubbock.

Daniel Bulkley of San Antonio, cousin of the bride, served as ring bearer. The flower girls were Ashley Floyd, Lesley Floyd and Emily Floyd, all of Lubbock.

Tiffany Bowen and Christal Aycock, both of Lubbock, registered guest.

The reception followed in the church's fellowship hall. Mrs. Betty Johnson of Lubbock made both the bride's and the groom's cakes.

During the reception, the members of the bride's sorority, Kappa Kappa Gamma, sang *When You Find Your One and Only* and *I'll Be There*.

The couple are at home in Lubbock after a wedding trip to Cozumel, Mexico.

The bride is a graduate of Coronado High School and received her bachelor of science degree in education from Texas Tech University. She is a second grade teacher with Ralls School District.

The bridegroom is a graduate of Coronado High School. He received his bachelor of science and master degrees from Texas Tech University. He is currently a teacher and coach at Irons Jr. High School in Lubbock.

## Family reunion held on C.B. Wilhelm's birthday

Aug. 12, the descendants of Frank and Cecelia Wilhelm gathered in Nazareth for a family reunion and to celebrate the 80th birthday of C.B. Wilhelm, the only surviving child of a pioneer family of 13 children.

The day began with a mass celebrated by Msgr. B.A. Erpen of Tulia and Fr. Brendan Sherry of Amarillo. A number of family members participated in the liturgy.

Following the mass, everyone went to the Nazareth Community Hall for the noon meal. The blessing was given by Fr. Neal Dee, pastor of Holy Family Parish. All gathered around to sing the birthday song to C.B. as he blew out the candles on his cake, which depicted an old-time farm scene. The meal, which was served to 349 people, was catered by the Catholic Daughters.

Dean Wilhelm, master of ceremonies, introduced the descendants of the Frank Wilhelms, including daughters Margaret Schmucker, Josephine Maenner and Rose Warren; and sons Frank, Edward, Albert, Henry, Charles, Raymond and Clarence.

C.B. was crowned "Monarch" of the Frank and Cecelia Wilhelm family, and all sang "For He's a Jolly Good Fellow."

"This Is Your Life, C.B. Wilhelm" was then narrated by Dale Wilhelm, starting with C.B.'s parents, their move to Texas and C.B.'s birth on Aug. 13, 1910. C.B. still lives in the same house in which he was born 80 years ago.

The afternoon was spent visiting, renewing old friendships and making new ones, enjoying old photos and family histories. Many of C.B.'s friends came to wish him



C.B. Wilhelm

happy birthday during the open house. A buffet supper was served in the evening.

Nieces and nephews came from as far as Maryland and California, Michigan and Texas and many states in between. Thirty-five of C.B.'s 45 nieces and nephews attended, along with a large number of the 218 great-nieces and nephews and many of the 236 great-great nieces and nephews, and even one great-great-great nephew.

Also attending were Urban and Mickie Drilling of Cresco, Iowa, cousins of C.B.

Aug. 13, all the relatives still here gathered for a lawn supper in C.B.'s yard for more visiting and remembering.

"Everyone is looking forward to enjoying many more years of C.B.'s friendship," a family spokesperson said.

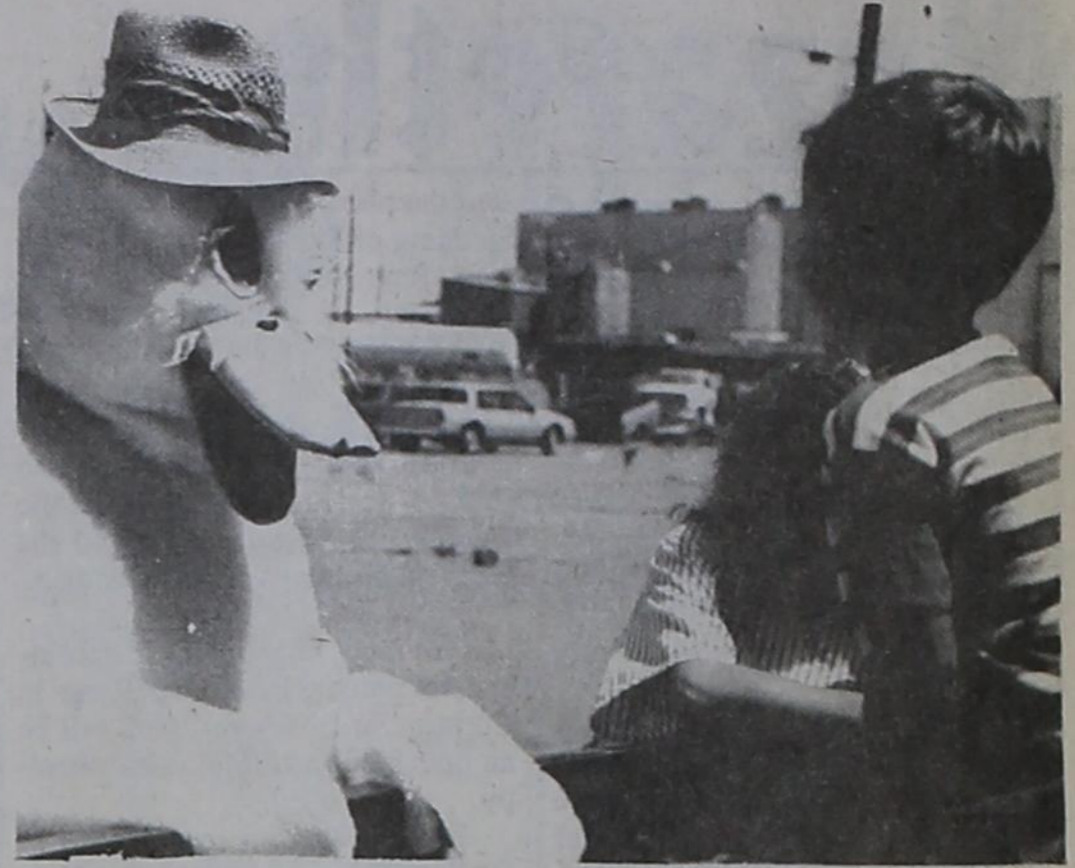

WHAT A "QUACK" UP—Dusty Kay gets a kick meeting the "duck" during the Harvest Day's celebration Saturday afternoon. The duck served as the mascot for the Kiwanis Duck Race. Funds raised from the Kiwanis' event will be used for community projects throughout the year.

**THIS WEEK'S 'FIND':**

### Three Oak Glass-Front Bookcases

Open 1-5:30 Monday through Friday  
Open 9-5 Saturdays

## TRADITIONS

PRESENT AND FUTURE ANTIQUES  
119 E. Bedford St.

You are invited to a  
Reception/Shower  
honoring  
**Mr. and Mrs. Tod Bradley**  
Saturday, August 25  
8 p.m. to 12  
in the home of  
**Mr. and Mrs. Stanley Schaeffer**  
116 Andrews St.

Selections at Judilee's, Parsons, Seale Florist  
and The Village Shop.

(Casual dress)

You are invited to witness  
the wedding vows of  
**Darla Underwood**  
and  
**Dr. Lee Baggett**  
on Friday, August 31, 1990 at 7 o'clock p.m.  
at the First United Methodist Church  
of Hart and to the reception following  
in the Fellowship Hall.

# Double Offer.

**Free Gift.**  
The Country Autumn Bonus. Free With Any \$14.50 Purchase.

Our Country Autumn Gift is yours, free, with any \$14.50 Merle Norman Cosmetic purchase.

There are eyeshadows in Rosewood and Smoke Blue, plus Spicy Rose lipstick, Luxiva Energizing Concentrate and Luxiva Night Creme with HC-12.

**Free Mini-Makeover.**

We have five new Mini-Makeovers that are fast, easy and make you look great. There's the Youthful Effects mini-makeover, the Quick And Natural, the Eye Enhancing mini-makeover, Your Best Colors and the Long Lasting Makeup mini-makeover.

**MERLE NORMAN**  
COSMETIC STUDIOS

JOYCE RICKERD

111 E. Bedford, Dimmitt 647-5773

Everyone is invited  
to a  
**Farewell Reception**  
for the  
**Seth Ralston Family**  
Sunday, August 26  
3 to 5 p.m.  
in the  
City Hall

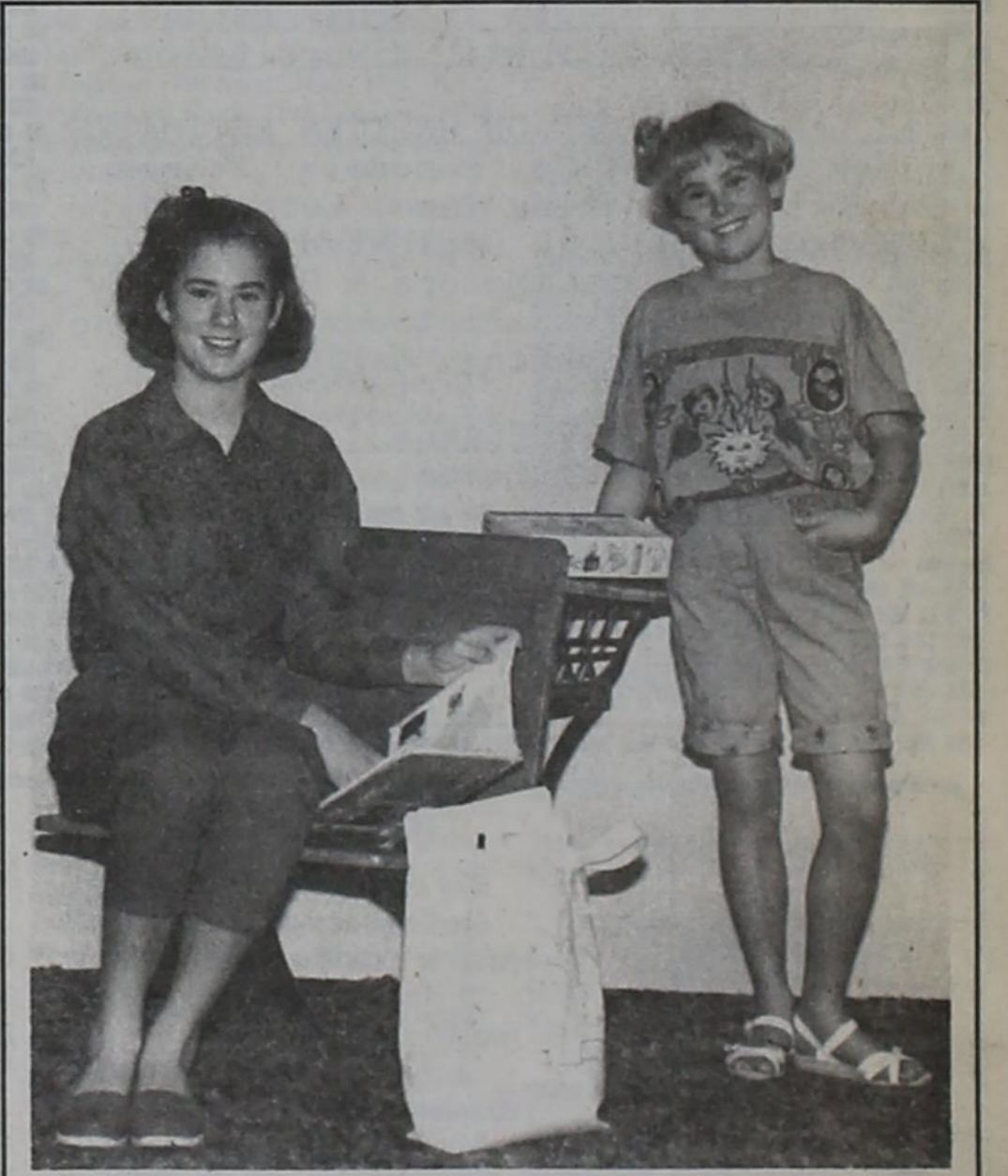

Emily and Allison Roberson just can't wait to go back to school in their new ITALIAN BOYS fashions from Tots and Teens. Emily, 11, wears an appropriate purple cotton set, while Allison, 9, chooses aqua print shorts and tee shirt of cotton. The girls are the daughters of Bill and Karen Roberson.

## Tots and Teens

101 E. Bedford, Dimmitt 647-2650

# Immunization rules will change Sept. 1

In preparing children for back-to-school, parents should be aware of new, more stringent immunization rules for all Texas children, which will become effective Sept. 1.

The Texas Dept. of Health is notifying all school and child-care facility administrators about the new rules. Still more changes in the immunization requirements, including a mandatory second dose of measles vaccine, are set for 1991.

Wes Hodgson, epidemiology coordinator for the TDH Immunization Division, said, "The large measles outbreaks which began in 1988 underscored the fact that measles and other vaccine-preventable diseases can pose tragic health threats unless all susceptible people are immunized against them."

Hodgson noted that some parents in recent years have failed to have their children vaccinated. Also, he said that some school and day-care operators have not kept adequate records.

"The result is a growing number of insufficiently immunized children and young adults at risk of measles infection," Hodgson remarked.

He added that currently the law requires all children entering Texas schools or day-care to show proof of immunization at certain ages against polio, tetanus, measles, rubella (German measles), mumps and diphtheria. In addition, the law

requires pertussis (whooping cough) vaccine for all school and day-care children younger than 5.

However, amendments adopted by the Texas Board of Health in June more sharply define, and in some cases change, children's immunization requirements. Among the major amendments are:

\*Beginning Sept. 1, 1990, children and students enrolling in Texas child-care facilities or schools must have received both mumps and measles vaccines on or after their first birthdays.

\*Beginning Jan. 1, 1991, students whose 12th birthdays occur on or after Sept. 1, 1990 will be required to have two doses of measles vaccine, or provide evidence of measles immunity. The two doses must be administered at least 30 days apart, and proof of the second dose will not be required until the child's 12th birthday.

\*Beginning Sept. 1, 1991, *Haemophilus influenzae* type b (Hib) vaccine will be required for children ages 18 months through 4 years.

\*Beginning Sept. 1, 1991, all children and students enrolling for the first time must have received rubella vaccine at age 1 or older.

Hodgson added that persons needing further details about immunization requirements should consult their family physicians, local health departments, or school officials.



**HOW INTERESTING**—Zonell Maples (left) and Rhoda Mays (right) tour the county museum during the Museum's Open House Saturday. Some other things the museum did was provide lemonade and surrey rides. Later in the afternoon, the "Flatland Bluegrass" band performed for museum patrons.

## Turkey shoot set Sunday

The Swisher County 4-H is sponsoring a turkey shoot Sunday from 1:30 p.m. till dark, with cash or turkeys for prizes.

The shoot will be located two miles east of Tulia on FM 1318, and then two miles north and then one mile east.

Light refreshments will be available. Funds will go to the Swisher 4-H Show Fund.



The Sweet and Simple Aid to Dieting. It's a Classy idea-eating cookies for Appetite Control. Fiber Classic Cookies—Rich Source of Fiber • Zero Cholesterol • Amazingly Satisfying • Totally Convenient Nutritious & Delicious.

**Parsons Rexall Drug**  
107 E. Bedford, Dimmitt

## Free health screening set

Senior Citizens of Castro County are invited to attend a free health screening today (Thursday) from 10 a.m. to 2 p.m. at the Castro County Senior Citizens' Center in Dimmitt.

Screenings will be performed for eye problems, eye pressure, glaucoma, blood pressure, and blood sugar.

The event is being co-sponsored by the Senior Citizens Center and Currie Eye Institute of Amarillo. Other participants in the screening will include Plains Memorial Hospital Home Health Agency, Dimmitt's Lifeline, the Dimmitt office of Panhandle Community Services, Hi-Plains Eye Bank, and Dryden Insurance.

A unique and personal way to say you care  
**BASKET GIFTS UNLIMITED**  
FREE DELIVERY  
Phone 647-3558  
704 Maple  
Dimmitt, Tx 79027

**GLASS**  
We install new windshields and windows weather-tight in your car, pickup, tractor-combine cab, etc. Large stock on hand. Experienced, fast, efficient!  
**Dimmitt Uph. & Garage**  
214 N. Broadway 647-2534

*The Ettie McDermitt Nursing Scholarship Organization offers our sincerest apology for the late and unfilled orders for stuffed potatoes. Your response was overwhelming and unexpected, and your support was very much appreciated.*

*A very grateful appreciation goes to Carl Bruegel for donating potatoes, and to the many others who donated supplies, food, money and their time to make the stuffed potato sale a success.*

## Churches are invited to Family Fare Day

Dimmitt's Fourth and Bedford Church of Christ invites other area congregations to participate in their "Family Fare Day" Sunday, which is designed to celebrate the family.

Organizers of the event recognize that other congregations are obligated to their own morning worship services, but wish to encourage participation in the afternoon activities, including a luncheon from 12:15 to 1:30 p.m. at the Senior Citizens Center in Dimmitt.

Following the luncheon, Session Three in a series led by David Mathews and Adrian Hickmon of Family Adventure Foundation from Monroe, La., will be held from 1:30 to 2:15 p.m. Session Four will be held from 2:15 to 3 p.m.

After a break, "His Image Singers" from Tulia will share their music from 3:30 to 4:10 p.m., and Closing Challenges will be issued from 4:10 to 4:30 p.m., with families encouraged to sit together during these times.

All sessions, other than the luncheon, will be held at the Fourth and Bedford church building, with different age groups meeting in designated classroom areas and in the main auditorium.

Any wishing to participate in the early sessions may come from 9:45 to 10:30 a.m. for Session One, and from 11:30 a.m. to 12:15 p.m. for Session Two. Worship services will be held from 10:40 to 11:20 a.m.

## What's cooking?

Here are the school lunch menus for the week of Aug. 27-31:

### DIMMITT

**MONDAY** — No School until Tuesday.

**TUESDAY** — Cheeseburger, French fries, lettuce, pickles, onions, peaches, milk.

**WEDNESDAY** — Pizza, whole-kernel corn, sliced tomatoes, chocolate pudding, milk.

**THURSDAY** — Chicken-fried steak with gravy, creamed potatoes, green beans, rolls, butter, honey, milk.

**FRIDAY** — Tacos with cheese, pinto beans, lettuce and tomato salad, fruit juice bar, milk.

### HART

**MONDAY** — Chicken strips, cream gravy, whipped potatoes, green beans, hot rolls, brownies, milk.

**TUESDAY** — Enchilada

casserole, tossed salad, buttered corn, tortillas, pineapple cake, milk.

**WEDNESDAY** — Cheeseburger, lettuce, tomato, pickles, French fries, peaches, milk.

**THURSDAY** — Baked ham, pinto beans, potato salad, wheat rolls, apple cobbler, milk.

**FRIDAY** — Pizza, tossed salad, buttered corn, blueberry cobbler, milk.

### NAZARETH

**MONDAY** — Tacos, corn, hot rolls, peaches, milk.

**TUESDAY** — Spaghetti with meat sauce, tossed salad, hot rolls, pears, milk.

**WEDNESDAY** — Hamburger, French fries, brownies, milk.

**THURSDAY** — Corn dogs, baked potatoes, grapes, milk.

**FRIDAY** — Chicken-fried steak, whipped potatoes, gravy, green beans, hot rolls, gelatin, milk.

# Plant a Bluebonnet Fast Bloomer C.D. and watch it grow.

**3 - Month CD\***

**\$1,000 minimum**

**7.875%**

**6 - Month CD\***

**\$1,000 minimum**

**7.875%**

**1 - Year CD\***

**\$1,000 minimum**

**7.625%**

Bluebonnet Savings Bank is rich soil indeed for C.D.'s. With rates\* like these, your money literally blooms right before your eyes.

Bluebonnet's high-yield Fast Bloomer C.D.'s grow financial roots that are deep and secure and the results are downright beautiful.

Interested in a friendly neighborhood approach to banking? Then stop by your nearest Bluebonnet Savings Bank branch. We'll show you how together, we can grow a better future.

**BLUEBONNET**  
SAVINGS BANK FSB  
Firmly rooted in Texas

216 N. Broadway 647-2118 Rhonda Rutkowski

\*\$1,000 minimum deposit. Rates subject to change without notice. Annual Yield based on simple interest. Substantial penalty for early withdrawal.

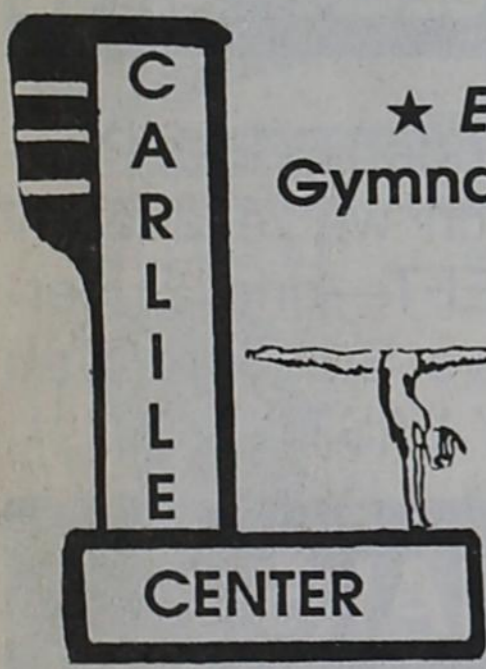

★ **Enroll Now** ★  
**Gymnastics, Aerobics, Karate**



Girls, Boys, Adult Classes  
Beginning Immediately

Call  
**647-3454**

114 S. Broadway

We are finally open and wish to say thanks for the support and participation from our area friends during the first week of business. Everyone is welcome to come see our gym facility. We believe you will be surprised! A special thanks to Sandy and Theresa Parsons, Jerry Frazier, E.L. Washington, Dale Bailey, and Eddie Harris for all their hard work, and the Dimmitt Chamber of Commerce for their support.

Johnny, Janie, Jennifer and Jade Vick

# Sports

## Bobcats hope to 'fill the gaps'

This year's Bobcats have both experience and promise.

With starters back at nine defensive and six offensive positions, they're expected to be in the thick of the District 2-AAA championship race this season.

And they have a "terrific" attitude, according to Head Coach Army Salinas.

What they *don't* have is numbers.

More than a dozen players who were expected to report for two-a-day workouts, didn't.

That includes six of last year's varsity squad members.

"At one point last week we had only 17 kids who could be classified as varsity players," Salinas said. "We've moved some sophomores up to fill out the squad."

The Bobcats, now in their second week of two-a-day workouts, are looking forward to their first scrimmage Friday evening at Morton, and their annual Picture Day, Ice Cream Social and "Meet the Bobcats" program Saturday evening.

Salinas hopes that some of those who didn't report for two-a-days will change their minds with the start of school next week.

"If they're willing to pay the price these kids have paid, we'd certainly be willing to talk to them," he said.

With Salinas, it isn't just a mat-

ter of filling out a roster.

"The most disappointing thing to me is that these kids who didn't come out will miss all the things a good program can do for them—the camaraderie, the commitment, the discipline, the accomplishment, the feeling of self-worth, the thrill of being part of a winning team," he said. "I know from experience what a good football program can do for a kid, and I know that a lot of the kids who didn't come out are someday going to regret not having done it."

Although he's discouraged about his number of players, "I'm optimistic about our chances," Salinas said.

"Our goal this year is to win district," he told the Lions Club last week. "This is my third year here, and we've knocked on the door our first two seasons. This is the year I want to do it. I want the kids to get to experience that thrill that comes with winning a district championship."

It doesn't bother Salinas that Tulia and Floydada are ranked 1-2 in the district, with Dimmitt third. Both of his previous Bobcat teams blew past their pre-season rankings.

The Bobcats lost only seven seniors from last year's 5-4-1 squad. But the no-shows have increased the number of roster gaps to 13.

That will put a lot more pressure on the returning experienced players.

The Bobcats are fairly rich in returning offensive starters:

—Freddy Martinez, all-district senior quarterback.

—Michael Ethridge, all-district senior split end.

—Johnny Ortegon, all-district senior fullback.

—Robert Ruiz, all-district junior running back and kicker (who is playing tight end this year).

—Ryan Hardee, two-time all-district senior guard.

—Albert Ramirez, senior tackle.

And they're even richer in returning defensive starters:

—Billy Ray Thomas, all-district junior strong safety (who also will play offensive halfback).

—Armando Arce, junior cornerback (who will double as tailback on offense).

—Ethridge, an all-district cornerback.

—Ruiz at defensive end.

—Levi Reynolds, junior defensive end (who also will start at offensive center).

—Hardee, who played tackle on defense last year but who has moved to linebacker.

—Paul Axtell, senior tackle.

—Luciano Quiroz, junior nose



guard.  
—Arthur Velasquez, senior nose guard and tackle (who will play tackle on both defense and offense this season).

That's a lot of experience — especially compared with this time last year, when Hardee was the lone returning starter.

But it isn't nearly as much experience as the coaches were counting on. These 12 make up the entire crop from last year's varsity roster who reported for two-a-day workouts.

Some of these returning starters were pressed into starting roles near the end of last season, Salinas explained, noting that six sophomores started the final two games.

Also returning for duty are juniors Lincoln Stewart (free safety and quarterback) and Juan Martinez

(guard and linebacker), both of whom were brought up from the JV for the last two games last season. Stewart started both of those games as a sophomore free safety.

Others up from last year's JV this season are senior Rodney Kilough and juniors Albert Rivera, Casey Summers, Monty Moore, Coby Heller and Andy Bermea. To

fill out the short varsity roster, sophomores Jeromy Casey, Zach Smith and Chris Hutson have been moved up during two-a-day workouts.

With all returning lettermen now in starting roles, and with many of them doing double duty, "The key is whether we can stay healthy," Salinas said.

### Southwest Outdoors

with Mel Phillips

In my first column, I mentioned that "I have met and continue to meet some terrific people who will share their expert knowledge with you." During the last two weeks I have sponsored two fishing tournaments and these fishermen are terrific.

The Baylor Big Bass tournament was a huge success not because of the number of huge bass that live in that lake, but because virtually every angler had caught bass bigger than the winning entry. Ron Griffith caught a 5.6 pound and won \$2,200. At the final weigh-in several competitors noted that a five pounder would never win big bass in the fall. After checking with Roy Rappavi at Lake Baylor, permission was granted for two additional Big Bass Tournaments: the first Saturday in September and the first Saturday in October. Entries are limited to 100 anglers and will cost \$60.

The anglers competing for thousands of dollars in prize money are a dedicated group but willing to share some of their secrets. Griffith gave credit to Canyon Angler RANDY ABBOTT for suggesting the right color and kind of lure. Griffith was having a tough day until he tied on a pumpkin/green flake saltcraw.

FISHING IS A UNIQUE SPORT where contestants help each other even while competing against each other.

The FUN TOURNAMENT at Lake Meredith was exactly that: fun. An entry fee of only \$15 combined with a Thursday evening

fishing time of 6 until 9 p.m. gave everyone a chance to try their luck in either the Bass category or the Walleye category.

TRENT LOUKAS, who is getting married this Saturday, edged out 127 bass anglers with a total of 4.22 pounds and earned "fun money" of \$635. At the weigh-in Loukas credited his dad, Alex, with teaching him how to fish and a "rattle trap" for catching the winning fish.

MELVIN MILLS of Sanford, throwing a white spinnerbait, was second with 3.71 pounds and took home \$317.50. Third place money of \$254 went to DAVID CONDITT while fourth place money of \$158.75 was earned by RODNEY CLAWSON of Gruver. In the "lucky" category was 10th place finisher DICK PINCKERT, winning \$158.75 for a 1.95 pound bass.

Only 30 anglers entered the Walleye category and Borger angler MICHAEL PAIGE, JR. took home all the prize money. Right, all the prize money because he caught and weighed in the only keeper walleye. Several bass fishermen caught walleye BUT they were not entered in the walleye category.

Oh, by the way Michael Paige, Jr. won \$285 and at the ripe age of 11 has no idea how to spend it. Just wait Michael, just wait.

Next Fun Tournament is Thursday evening Aug. 23 at Lake Meredith.

### Picture Day, ice cream social slated Saturday

Big doings are on tap at Bobcat Stadium Saturday afternoon and evening.

The annual pre-season "Picture Day" will start at 4 o'clock. The Bobcats will be suited up in their game uniforms for picture-taking by both professional and amateur photographers. Pictures for newspapers, yearbooks, Booster Club placards, football programs and other uses will be taken.

All parents and fans are invited to bring their cameras and take pictures, or have their pictures taken with their favorite players.

At 6 p.m., the Dimmitt Athletic Booster Club will hold its annual "Meet the Bobcats" program at the stadium to introduce all coaches and players, from freshman through varsity levels.

After the program, Booster Club members will serve homemade ice cream to all attending.

The event is open to all students, parents and fans.

Women first competed in the modern Olympic Games in 1900.

**Sunday, August 26th**

*Family Fare Day*

A TIME TO CELEBRATE THE FAMILY

**4TH AND BEDFORD CHURCH OF CHRIST**

## NEW! GRILLED CHICKEN SANDWICH!

A tender, marinated chicken breast fillet, grilled and delicious. Crisp lettuce, fresh tomato, and light mayonnaise. All on a whole wheat bun. That's the new Grilled Chicken Sandwich from Dairy Queen.

**LESS THAN 300 CALORIES**

**THIS IS DQ COUNTRY**

**Wallace Motor Co.**

647-2115 North Hwy. 385, Dimmitt

**Dr. Morris Webb**  
OPTOMETRIST  
Office Hours 9-5  
Monday through Friday  
**647-4464**  
300 W. Bedford, Dimmitt

**Ford FORD**

## Ford Trucks. The Best Never Rest.

**FACTORY AUTHORIZED CLEARANCE**

We're CLEARING OUT our '90 model F-150 Pickups to make way for the '91s, which we've already ordered. We have ONLY FOUR LEFT—one Supercab model, one 4WD model and two Standard Cab models. SAVE NOW—WHILE THEY LAST.

**SERVICE SPECIALS**

Wash and Complete Clean-up.....\$14.00

Oil Change and Lube.....\$15.95  
(includes 5 qts. oil, new filter and grease)

**Wallace Motor Co.**

647-2115 North Hwy. 385, Dimmitt

® Reg. U.S. Pat. & Tm. Off. Am. D.Q. Corp. /TM Reg. U.S. Pat. & Tm. D.Q. Op. Coun. © Tx. D.Q. Op. Coun.





**DARNELL ADAMS**  
16:05



**SUSAN CASILLAS**  
23:35



**CARLOS MORENO**  
22:45



**JERRY WHITTEN**  
27:06

## Reserved seats go on sale Aug. 27-31

Reserved seat tickets for the 1990 football season at Dimmitt's Bobcat Stadium will be offered for sale from Aug. 27-31 to last year's reserve ticket holders.

Any reserve seat tickets not renewed within that time will be offered for sale to the general public on a first-come, first-served basis, starting Sept. 4.

Season tickets are priced at \$20 per person for all home games for the 1990 season.

The tickets may be purchased at the DISD administration building at 608 W. Halsell in Dimmitt, during

the office hours of 8 a.m. to 12 noon and 1 to 4 p.m.

### WATERMELONS FOR SALE

4-1/2 Miles North of Dimmitt

Donald Schilling

## Darnell Adams wins Harvest Days race

Darnell Adams, 25, of Plainview, bested a crowd of 46 entrants in the 1990 Harvest Days 5K Race and Walk held in Dimmitt Saturday morning, but failed to set a race record by four seconds.

Adams' time of 16:05 for the 3.1-mile course failed to break the old record of 16:02, but placed him well ahead of the over-all second place runner, Dimas Samarron, 24, of Earth, who was clocked at 16:31. Third to cross the finish line was Kenrick Williams, 33, of Plainview with a time of 17:36.

The first female runner to cross the line was Susan Casillas, 25, of Clovis, N.M., with a time of 23:35.

Second among the women was Brandee Funk, 18, of Canyon, with a time of 23:55. Third-best time for the women was clocked by Tammy Thompson, 31, of Amarillo at 24:15.

The youngest runner was Carlos Moreno, 13, of Tulia, who registered a time of 22:45, taking the first place trophy for the men's division for age 14 and under.

In the women's 19 and under division, first place went to Funk and second went to Malinda Moreno, 14, of Tulia, with a time of 24:43.

For women age 20 and up, Casillas took first, Thompson won second, and third went to Luanne

Lane, 28, of Amarillo, with a time of 25:30.

The men's 15-19 age group was topped by Henry Ruiz, 18, of Hereford, who posted a time of 19:29; second went to Danny Frohnofer, 19, of Clovis, at 19:41; and third was taken by Juan Martinez, 18, of Hereford, at 20:34.

For men in the age 20-29 division, Adams took first, with Samarron second, and Monte Wells, 28, of Amarillo third, with a time of 18:35.

Williams took first in the men's division for ages 30-37. Second went to Richard Martinez, 33, of Hereford at 17:47, and third was won by Raymond N. Donaldson, 30, of Amarillo, with a time of 18:36.

For men ages 38-44, first place went to Rodolfo Moreno, 38, of

Tulia with a time of 19:24. Guillermo Carbajal, 40, of Tulia took second with 19:47, and Arnold Martinez, 39, of Clovis was third at 20:02.

First place for men age 45 and over went to Dr. Mike Kendall, 47, of Amarillo, with a time of 20:26. Second went to Don Marsh, 51, of Amarillo, who posted a mark of 20:44. Hal Wilkerson, 45, of Tulia took third with a time of 20:48.

Only one walker competed — Jerry E. Whitten, 47, of Amarillo. He posted a time of 27:06, and was awarded a trophy.

## Scrimmages set

The Bobcats, Longhorns and Swifts will all hit the road tonight (Thursday) or Friday for their first pre-season scrimmages.

Hart's Longhorns will travel to New Deal today for scrimmage sessions against the Lions. The two squads will start "popping leather" at 6 p.m., with the varsities first, and will alternate series of plays between older and younger squads. The scrimmage will last approximately two hours.

Coach Alan Cherry's Longhorns will travel to Tulia next Thursday for their final pre-season scrimmage—tentatively scheduled for 5 p.m.—before opening their regular season at home against Anton Sept. 7.

Dimmitt's Bobcats will travel to Morton Friday for a junior varsity scrimmage at 6, followed by a varsity set-to at 7.

The Bobcats will host Shallowater's Mustangs Aug. 31 in their second pre-season scrimmage. They'll open the regular season

Sept. 7 against Roosevelt, there.

Nazareth's Swifts will go to Amarillo Friday evening for a scrimmage session with Highland Park. Starting at 6 p.m., varsity and junior varsity squads will alternate scrimmage series.

Coach Rick Price's Swifts will be at home for their final pre-season scrimmage, hosting Lorenzo next Thursday at 6 p.m. They'll also be at home for their opening game Sept. 7 against Lubbock Christian High.



Chance Ray Schilling, son of Roy and Carla Schilling, entered the world at 6:22 a.m. Aug. 15. He weighed 6 pounds and 4 1/4 ounces and was 19 1/4 inches long. His paternal grandparents are Donald and Agnes Schilling of Dimmitt. Maternal grandparents are Gerald and Patty Summers of Dimmitt. His great-grandparents include Juanita and Melvin Summers of Dimmitt and Bobby George all of Dimmitt. Great-great-grandmothers are Cletha George and Lillian Holister both of Dimmitt.

## Bobcats, Indians will scrimmage

Dimmitt's Bobcats will get an idea of how well they're doing so far when they travel to Morton Friday for their first pre-season intersquad scrimmage.

The freshmen and junior varsity will scrimmage at 6 o'clock, followed by the varsity scrimmage at 7.

"All we've done is hit each other so far; it will be nice to hit someone else for a change," Bobcat Head Coach Army Salinas commented.

The following Friday (Aug. 31), the Shallowater Mustangs will come to Dimmitt for a scrimmage.

The Bobcats will begin regular-season play Sept. 7 at Roosevelt. Their first home game will be against Brownfield Sept. 14. The first home game has been designated "Parents' Night."

## Swifts will be guests of honor at Sunday party

Nazareth High School will host a "Football Picture Day and Ice Cream Social" Sunday afternoon for the Swifts football team, coaches and cheerleaders.

The photo session will begin at 2:45 p.m. at Swift Field, with pictures being taken of the football players, coaches, and high school and junior high cheerleaders for the football program, yearbook and newspaper. Family members and friends also are encouraged to bring their cameras and photograph their favorite players in game uniforms.

The ice cream social will begin at 3:30 p.m. at the stadium.

All players' families, students and fans are urged to attend and show their support for the Swifts.

## Wrestling to benefit Naz

A wrestling match featuring Dick Murdock and other pro wrestlers will be held Sunday night at the Nazareth Community Center to benefit the Nazareth Athletic Dept.

The event will begin at 7 p.m., with ring-side tickets priced at \$7 each, and general admission set at \$5. Tickets can be purchased in advance from any booster club member or at Richard's Town Pump, The 19th Hole, or Corner Package.

Hamburgers, popcorn, candy and drinks will be for sale at the concession.

★ SUNDAY ★  
August 26, 7 p.m., Nazareth Community Center  
**WRESTLING ★ FEATURING**  
Dick Murdock -vs- The Super Destroyer  
Johnny Long -vs- Ted Heath  
Chris Youngblood -vs- Greg Robertson  
Rocking Roger -vs- Scott Sanders  
Also featuring  
Chris Romero



**Therapeutic Self Help & Hypnosis Center**  
Certified Therapist  
Donny Harland

- Chronic Pain Control
- Weight Reduction
- Stop Smoking
- Depression
- Nail Biting
- Bed Wetting
- Insomnia
- Alcoholism
- Drug Addiction
- Allergies
- Concentration Skills
- Improving Memory
- Phobias or Fears
- Building Self Esteem
- Recovery from illness and surgery
- Anxiety and Stress
- Enhancing talents and skills creativity
- Grinding Teeth

**What is hypnosis?** A natural state of mind, mental and physical relaxation.

**How does it work?** Increasing mental awareness on select suggestions and ideas.

**Why is it so effective?** Ideas and suggestions go directly to the subconscious without conscious censorship and become positive truth, activating involuntary body functions to support ideas.

**Will a person accept negative suggestions?** No, conscious awareness is never lost, only passive (like a daydream).

No hypnosis is not a magic wand, but rather a scientific therapy, that brings positive results.

For free consultation or information call  
**Therapeutic Hypnosis Center**  
995-3101  
995-2827  
Tulia, Texas

## Sunday, August 26th

*Family Fare Day*

A TIME TO CELEBRATE THE FAMILY

### 4TH AND BEDFORD CHURCH OF CHRIST DIMMITT, TEXAS

## A SPECIAL PROGRAM FOR THE WHOLE FAMILY

### 9:30 — 4:30

You are invited to spend a special day with us on Sunday, August 26th. The day is being designed to celebrate the family. Please join us starting at 9:30 and stay for the day. We will have lunch provided (Free) at the Senior Citizen Building at noon. If you can't come in the morning, come for lunch and stay the rest of the afternoon.

For Additional Information Call 647-4435



WHAT TO BUY? WHAT TO BUY?  
... Bargain shoppers at the fair

### Volleyball tourney winners announced

**ADULT DIVISION**  
First place team—"Just Friends", consisting of Mary Lou Lumbrera, Johnny Montalvo, Corina Montalvo, Jerry Casares, Thomas Hernandez, Gloria Hernandez and Alice Acevedo.

Second place team—"Lemons Team," consisting of Lori Lemons, Max Newman, Karen Newman, Cathy Ethridge, Jim Birdwell and Darrell Buckley.

Third place team—"First State Bank," consisting of Joe Josselet, Nancy Fuller, Patty Cartwright, Kathy Welch, Randy Smithson, Mike Bain, Mark Bain and Prissy Boothe.

**YOUTH DIVISION**  
First place team—"Methodist #1," consisting of Halley Bradley, Michelle Schumacher, Chip Thrasher, Christian Braafladt, Corina Born and Levi Reynolds.

Second place team—"Neato BANDITOS," consisting of Sharla Jackson, Tara Grand, Chad Killingworth, Fabian Longoria, Roger Gauna and Candy Matthews.

Third place team—"Farm & Bearing Nuts," consisting of Janay Johnson, Jodi Johnson, Barry Hill, Sherry Lytle, Casey Summers, Chip Thrasher and Richard Newman.



PARACHUTE JUMP  
... Mitchell Brockman

# Harvest Days, 1990



TAKING A RIDE IN THE PAST  
... Edgar Dennis and Betty McCall offer surrey rides during the Museum open house on Saturday.



IT'S NOT BASKETBALL, GIRLS. IT'S VOLLEYBALL!  
... Nazareth Swiftettes hoping to win.



HORSESHOE PITCHING  
... Danny Newton

### Prize winners during HD fair

Betty Freeman, Virgil Brockman and Clotee Minschew each won a \$15 gift certificate from Harman's.

The flower arrangement from Seale's Florist was won by Suzanne Phillips.

Janice Bell won a \$25 gift certificate from Village Shop.

Debbie Fuentes won a basket from Coleman's Pharmacy.

The lamp from Perrys was won by Charla Chesher.

Mitzie Heller won a \$25 gift certificate from Tots and Teens.

Bobby Martinez won a \$25 gift certificate from Sheffy's Western Wear.

The \$300 cash went to Aural Davis.

Janelle Dillehay of Canyon won the quilt.

### Schillings top in horseshoe tourney

The first place team was Randy Schilling and Kyle Schilling.

Second place team was Norman Hays and Darrell Buckley

The third place winners were Danny Newton and Rex Lutz.



ENJOYING THE LEMONADE—(from left) Velma Woodburn of Roswell, Frankie Norwood of Roswell, Mavis Burnham of Friona, Homer Norwood of Friona, Ralph Lambright of Dimmitt, George

Bagwell of Dimmitt, Lon Woodburn of Dimmitt and Nola Wood of Dimmitt drink some lemonade and talk about old times at the Museum's Open House Saturday.

# Great people having a great trip 'Around the World'



FIRST-PLACE PARADE FLOAT, COMMERCIAL DIVISION  
... First State Bank's tribute to the county's products

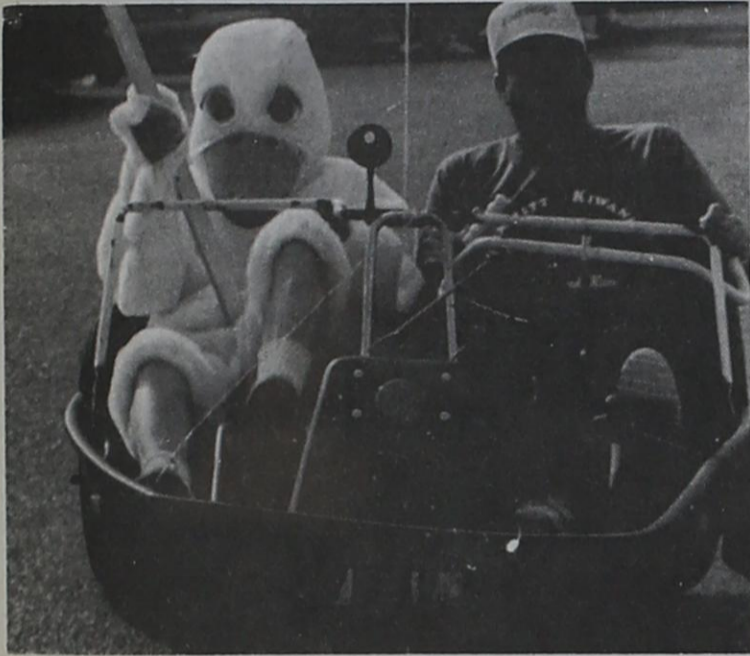

ACIE BOYD WITH THE KIWANIS DUCK  
... Peddling instead of paddling



BLUEBONNET SAVINGS BANK F.S.B. FLOAT  
... Runner-up in Commercial Division



FIRST-PLACE ANTIQUE CAR  
... '31 Model A Ford—Lyttan Stark, Plainview



WINNING FLOAT, CLUBS AND ORGANIZATIONS DIVISION  
... Panhandle Community Services

## Parade results

Here are the winners of Saturday's parade:  
**CLUBS AND ORGANIZATIONS:** 1. Panhandle Community Services 2. Assembly of God Church.  
**CARS:** Antique Car Best of Show, Lytta Stark, 1931 Model A Ford Tudor Deluxe; Classic Best of Show, Jame Davis, 1965 Ford Mustang; Hot Rod Car Best of Show, Coby Moke, 1938 Plymouth 4 door Sedan.  
**COMMERCIAL DIVISION:** 1. First State Bank of Dimmitt 2. Bluebonnet  
**ORIGINAL AND UNIQUE:** 1. ICC Clown Ministry 2. Dale Winders  
**BICYCLES:** 1. C.J. Smotherman 2. Ramey Rice 3. Jade Vick  
**BEST DRESSED COWGIRL:** Kami Jo Hand  
**BEST DRESSED COWBOY:** Justin Stevens



HERE COME THE 'WHEELERS'!  
... Decorated vehicles spiced up parade

# Police Calls

Saturday an inmate from the Castro County Jail escaped, but was recaptured Tuesday afternoon in Amarillo.

David Tony Silva, 21, was being held on burglary charges and was a trusty at the jail.

Potter County Sheriff's deputies arrested Silva at a relative's home about 2:30 p.m. after authorities received an anonymous tip as to his whereabouts.

Silva was transported to Castro County jail yesterday evening.

Three of the Potter County deputies were treated for minor injuries following the arrest of Silva.

Sometime last Thursday or Friday, an unknown suspect removed sound equipment from the First Baptist Church of Dimmitt. The stolen items are valued at \$900.

According to police reports, police were contacted by Earth Police Chief Tim Turley in reference to a stolen vehicle. On Saturday, police found the stolen vehicle at a local convenience store in Dimmitt. Three suspects were arrested and booked in the county jail for unauthorized use of a vehicle.

Sunday, police were notified of a stereo and amplifier stolen from the Immanuel Baptist Church of Dimmitt. The approximate value of the items was \$550. The matter is still under investigation.

An accident was reported Sunday in the 600 block of Hwy. 385. Oather Theodor Vardell of Dimmitt was attempting to pull out of a driveway and go west on 385. While crossing over the east bound lanes, his vehicle was struck by a vehicle driven by Wayne Keith Sims of Hereford who was going east on Hwy. 385. Vardell was treated and released from Plains Memorial Hospital for minor injuries.

## More about

### Lumbrera ...

(Continued from Page 1)

prison time assessed if she should happen to be found guilty.

Lumbrera was not brought to Texas to face the Parmer grand jury, and Kansas authorities have said any extradition proceedings would have to wait until all of the legal proceedings in Kansas are completed.

Castro County Sheriff's Deputy Jerry Bailey reported that, "We presented what evidence we had to show similarities in intent and method, etc., but the judge ruled against (allowing the Texas evidence)."

Bailey remarked that in some instances in Kansas law, prior events can be brought to show intent or method.

"But the judge, in citing case law, decided if he were to allow any of the previous deaths, it would only be the three for which she was already indicted, because there haven't been indictments handed down or warrants issued in the other deaths, yet," Bailey said.

"He (the judge) also felt that if he did allow it (the Texas testimony) in and it did meet some criterion of law, the prejudice of evidence entered would have been so damaging, it would have been hard for the defendant to have a fair and impartial trial, and it would have prejudiced the jury," Bailey explained.

A pre-trial hearing is set for Sept. 13, with jury selection to begin Sept. 19, and the hearing of evidence to begin Sept. 24.

## Church Happenings

### Immaculate Conception Catholic Church

The Holy Cross Society will sponsor a "Return to School Dance" Friday from 9 p.m. to 12:30 a.m. at the Expo Building. Entrance fee will be \$3.50 per person, and the DJ will be "Doctor Tune Show—Hi-Fi Video Jam Box."

### Presbyterian Happenings

Sunday Church School classes will meet Sunday at 10 a.m.

"Projections" will be the subject of Pastor Edward D. Freeman's sermon at the Sunday worship service at 11 a.m.

There will be a church family ice cream social Sunday at 7 p.m. at the home of Ruth Cochran.

### Ministerial Alliance

Vernon O'Kelly will lead the Castro County Ministerial Alliance in a study of Matthew 8:23-27 on Tuesday at 10 a.m. at the First United Methodist Church of Dimmitt.

## Substitute inservice set

A substitute teacher inservice will be held Friday from 10 a.m. to noon at the Dimmitt Middle School library.

Anyone wishing to substitute teach must attend the inservice before their name will be put on the substitute teacher roster.

For more information, call the DISD administration office at 647-3101.



**SPICY POODLES**—Julie Phillips, Earl Davis' granddaughter from Amarillo, shows off her three poodles, Pepper, Salt and Cinnamon at the Pet Show Friday afternoon. The poodles received the grand prize for "Best Dressed." There were 31 entries in the Pet Show which was judged by W.J. Hill.

## More about

### DHS ranked top 10%

(Continued from Page 1)

Stockstill said the answers will "most certainly" describe the PIE (Parents Involved in Education) program, the various programs which have addressed the "at-risk" student population (including the SMASH program, no longer in operation), and the recent open house, which featured a "mini schedule" for parents during Public School Week.

Factors Stockstill says have contributed to the school's academic accomplishments center around an emphasis placed on a positive school climate and high expectations from the administration toward teachers and from teachers toward students. He also cited the positive attitude on the part of students and the work ethic displayed by students, and their willingness to accept a challenge and work toward that challenge.

Obstacles Stockstill mentioned include the "entirely human resistance to change," and the presence of an element, which is present in every student body, which has a 'blase' attitude about school. He noted that such an attitude has been addressed through the at-risk programs and through the efforts of personnel who serve as role models and offer counseling for students.

The application also asks for statistical information, including the number of students enrolled in

advanced placement courses and honors courses, which Stockstill felt would be a "very favorable" statistic for DHS.

Other areas of comparison will include percentage of students involved in extra-curricular activities and in community service/volunteer activities, and percentage of teachers earning college credit in their subject areas in the last three years.

Winners of the excellence awards will be notified later in the fall, with the presentation ceremony scheduled for sometime in October.

Stockstill noted that it is an honor for DHS just to be nominated to receive an application, and said that he feels "DHS will compete very well."

# District Court judge hands down decisions

Ricky Joe Garibaldi, 24-year-old Dimmitt resident, was sentenced to serve 15 years in prison and a \$10,000 fine last week in 64th District Court following his plea of guilty to a local jury.

Garibaldi had been arrested for the March 8 burglary of an apartment in southwest Dimmitt leased by the Andy Rogers family. According to trial testimony, Rogers indicated that the family had lived in the apartment several months while constructing a new home in Dimmitt. The Rogers family was in Lubbock as the result of a hospitalization of a family member when the apartment was burglarized. Electronic equipment, women's coats and jewelry items were taken during the burglary. Rogers indicated that all but \$400 of the property was recovered, but that business records taken during the same incident were never recovered.

Among the business records taken was a bank credit card which was later used the same morning at the First State Bank of Dimmitt. Photographs made automatically by the bank teller machine revealed Garibaldi and a co-defendant allegedly attempting to use the card within hours of the burglary. The pictures also verified information contained in a search warrant obtained by the Dimmitt Police Dept. and in confessions later secured by the police.

Garibaldi pleaded guilty Friday to Credit Card Abuse resulting from the same incident, gave up his right to a jury trial and was sentenced by Judge Jack Miller to serve four years in prison.

Also on Friday, Adam Vasquez Lopez, 22-year-old Dimmitt resident and co-defendant to Garibaldi, pleaded guilty to burglarizing the Rogers residence and using the credit card taken in the burglary. Lopez was sentenced by Judge Miller to serve 20 years on the burglary charge and 4 years on the credit card case. On other co-defendant remains jailed and will go to trial in October.

Probation was revoked last Thursday for 22-year-old William

Scott Little, formerly of Truckee, Calif. Little had been convicted in 1979 for piloting an aircraft loaded with more than 500 pounds of marijuana which crashed west of Dimmitt more than 11 years ago.

After a lengthy trial in which a local jury granted probation to Little, he was subsequently convicted in California of offering to sell cocaine and sentenced to four year prison sentence at Folsom State Prison. Following the California incarceration, Little was picked up by local officers and immediately transferred to Dimmitt to face an application to revoke probation filed by County District Attorney Jimmy Davis.

Little was granted credit for the California prison sentence. He was sentenced by Judge Miller to serve six years in the Texas Dept. of Criminal Justice and to pay a \$5,000 fine.

Elodia Martinez, 48-year-old Dimmitt resident, also pleaded guilty before Judge Miller Wednesday to the charge of Tampering with governmental records in relation to food stamp applications.

She received a seven year prison sentence probated for three years and was fined \$300. She must also pay court costs of \$133, probation fees of \$1,440 and the Texas Dept. of Human Services \$670. She will also be disqualified from the food stamp program for seven years.

*this ..... not this*

**\$\$\$ DEALERS NEEDED**

Revolutionary new Mini Satellite Antenna. Excellent picture quality--tremendous demand

Wholesale \$587, Retail \$1,298, **BIG PROFITS!**

No experience necessary--serious inquiries only. Call SATE-LINK, (800) 762-7952, ext. 774. Operators on standby 24 hours.

# NOTICE

## 56TH ANNUAL STOCKHOLDERS MEETING OF DIMMITT AGRICULTURAL INDUSTRIES, INC.

All stockholders and their families are invited to attend the dinner and business meeting

**Monday, August 27, 1990**  
at 6:30 p.m.

in the Castro County Exposition Building

Dividend checks totaling \$201,891.20 will be distributed. Two Board of Directors members and two Associate Board members will be elected.

Many door prizes to be given.

### Dr. Milton Adams OPTOMETRIST

Office Hours: Monday-Friday, 8:30-5

364-2255  
335 Miles, Hereford

**DIMMITT EQUIPMENT CO.**  
Farm Equipment  
White Farm Equipment  
Irrigation Engine  
Sales and Service

647-2673 P.O. Box 576

**NOW LEASING WEST TEXAS MINI-STORAGE**

Lock it and leave it!  
647-3427 or 296-6372

### State Farm's Farm/Ranch Insurance

Protects your home, farm buildings, equipment, and livestock.

Call: **Kent Birdwell Insurance**  
116 E. Jones St.  
Dimmitt, Texas 79027  
Phone 647-3427

Like a good neighbor State Farm is there



State Farm Fire and Casualty Company  
Home Office Bloomington, Illinois

Sunday, August 26th

*Family Fare Day*  
A TIME TO CELEBRATE THE FAMILY

4TH AND BEDFORD CHURCH OF CHRIST

**HWI** special of the month  
the friendly ones

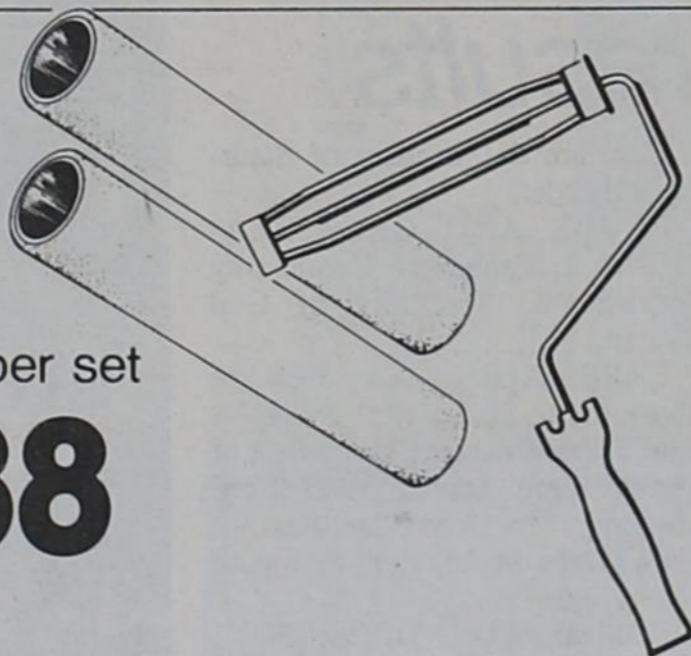

reg. 9.67 per set

**388**

Do it best  
2 pack, 3/8" NAP

9" 5-wire cage

**roller cover & frame**

788 277 / #629LH 000771 / #788990 While supplies last.

### Higginbotham-Bartlett Co.

109 N. Broadway, Dimmitt

647-3161

# Running Water Soil and Water Conservation District



## QUARTERLY REPORT—AUGUST 1990

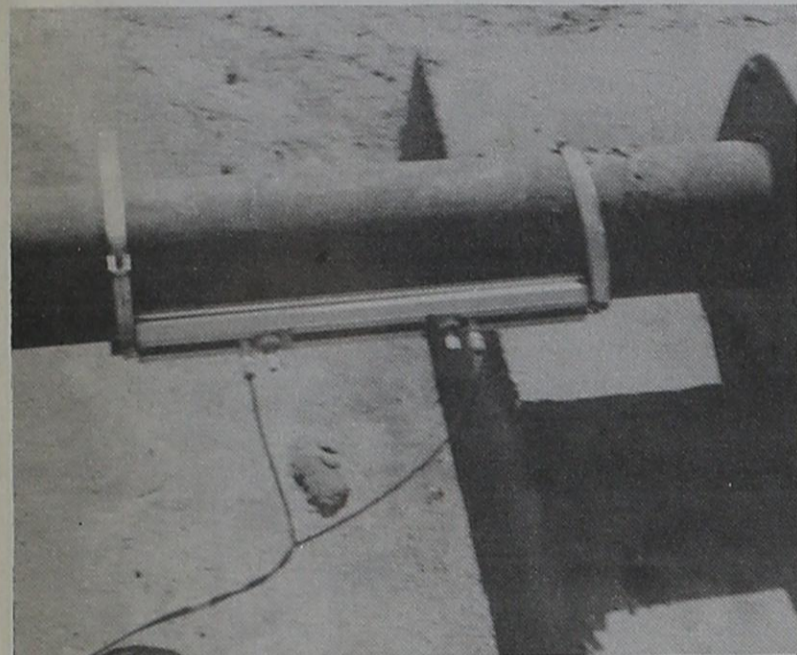
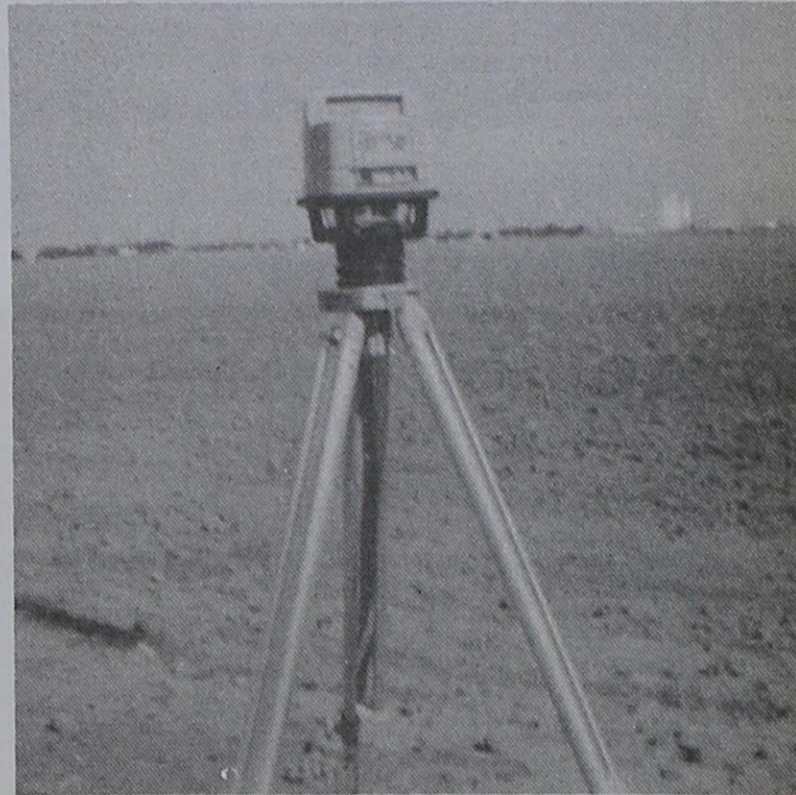

In May of this year, the Running Water Soil and Water Conservation District, with the assistance of a grant through the Texas Water Development Board, has purchased a Polysonic flowmeter and a Laser Level. With the Polysonic flowmeter, more accurate and precise information can be gathered on what an irrigation well is pumping, than information that is gathered from turbine flowmeters. Irrigation wells no longer have to be shut off and restarted like in the past when the turbine flowmeters were utilized. The Polysonic flowmeter can be used on center pivots, flowline, and at the well as long as there is about 3' of pipe where there is no disturbance, no cooling coils, or outlets. Since June 1, the local SCS office has checked 152 irrigation wells for producers in Castro County with the Polysonic flowmeter. The Laser Level, purchased by the district has been utilized on 12 engineering jobs such as checking out waterways, laying out ditch lines, making elevation maps and determining row directions. With both pieces of equipment the local SCS personnel has been able to provide local producers a quality service as well as making better use of their time. Anyone interested in having their wells and/or center pivots checked should contact their local SCS office in Dimmitt.



This year the local SCS office has assisted CRP producers in the seeding of about 10,000 acres to grass. At the present time, most of this grass is up and growing and is looking good. This past year, native grasses such as sideoats grama and blue grama were seeded. Castro County has 50,438 acres in the CRP program, with most of these acres established in grass. Again, the district would like to remind all CRP producers, that it is their (the landowner) responsibility to control the weeds that are on their CRP fields. With the moisture we have received lately, CRP producers need to take a good look at their fields and determine if a weed control will need to be applied. CRP producers could be assessed a penalty if weeds from their CRP contracts are allowed to blow on neighboring farms. CRP producers with questions should contact their local SCS personnel in Dimmitt.

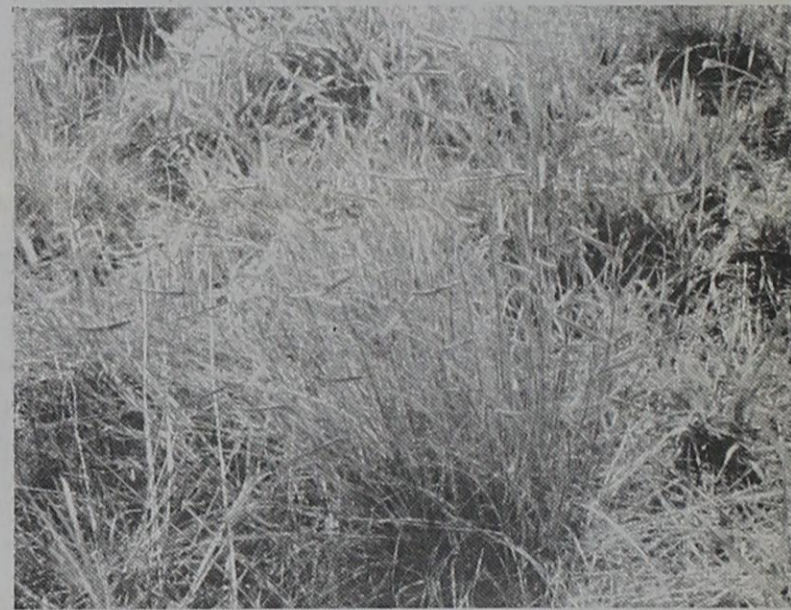

### Terra

Hwy. 385 North, Dimmitt 647-4125

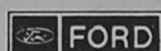

### Wallace Motor Co.

North Hwy. 385, Dimmitt 647-2115



### HAWKINS CONSTRUCTION

HCR 2, Box 95  
Hart, Texas 79043  
Phone (806)938-2206



Pecans

Gen. Dirt Work

### EASTER GRAIN, INC.

"Serving the Finest People on the Golden Spread"

(806) 276-5255  
Easter, Texas

### DIMMITT CONSUMERS, INC.

213 E. Bedford  
Phone 647-4134  
Dimmitt, Texas

Phone: 945-2219 - Box 217  
Nazareth, Texas 79063

### Kern Plumbing & Electric

Pumps Sales & Service  
"Your Business Appreciated"

CREDIT SPECIALISTS FOR AGRICULTURE  
647-3169 114 E. Jones, Dimmitt



Production Credit Association  
Ann Armstrong

DEAF SMITH ELECTRIC COOPERATIVE, INC.  
P.O. Box 753 Hereford, Texas 79045 Phone 364-1166

### DIMMITT AGRI INDUSTRIES, INC.

P.O. Box 728 Dimmitt, Texas 79027 (806) 647-2141

Programs and services of the Soil Conservation Service are offered on a non-discriminatory basis without regards for race, color, national origin, age, sex, religion, martial status or handicap.



BAMERT SEED COMPANY  
SPECIALIZING IN NATIVE GRASS AND PEARL MILLETS  
Most of our seed is variety named and raised under irrigated conditions.  
Phone 806-272-5506 or 800-262-9892  
Route 3, Box 1120, Muleshoe, Texas 79347

### E. M. JONES DITCHING

Irrigation Service  
506 SE 4th  
Dimmitt, Texas

### The Castro County News

Phone 806/647-3123  
108 W. Bedford, Dimmitt

### Dale's Auto & Salvage

General Mechanic Work  
Dale Acker, Owner  
Intersection 168 and 86, Nazareth 945-2223



### Lane Dirt Company

Dirt Work of All Types

LOADER — BACKHOE — ROADGRADER  
DOZER — DRAGLINE — DUMP TRUCKS  
WATER TRUCK — CALICHE

CHARLIE LANE  
647-5793 Day or Night

P.O. Box 971, 303 SE 3rd  
Dimmitt, Texas 79027



### PIONEER SEED DEALER

### Bob Kay Seeds

(806)938-2505

Route 2, Box 101A, Hart, Texas 79043

Distributor: Rosebud Delinting PR80 Cotton Seed



### KENT BIRDWELL INSURANCE

Auto-Life-Health-Home-and Business

116 East Jones Street, Post Office Box 157  
Dimmitt, Texas 79027  
Phone: Office, 647-3427, Residence 647-5561

### The First State Bank of Dimmitt

Member FDIC



### Castro County Farm Bureau

Phone 806-647-5106  
Box 155  
Dimmitt, Texas 79027



### Smithson Seed & Trailer Sales

647-4402 Rt. 4, Box 133, Dimmitt, Texas 79027



Agri Pro Seeds Wheat, Milo, Corn, Soybeans, Alfalfa and All Kinds Grasses



### Bob Towler Equipment Company

647-3324  
S. Hwy. 385, Dimmitt

# Obituaries

## C.D. Fitzgearld

C.D. Fitzgearld, 75, of Hereford died Aug. 17.

Services were held Monday at 10 a.m. in Rose Chapel of Gililand-Watson Funeral Home. Burial followed at Rest Lawn Memorial Park Cemetery.

Mr. Fitzgearld, born in Greenville, came to Hereford in 1955 from Lockney. He married Levita Jeffcoat in 1936 in Greenville. She preceded him in death in 1986. He was a retired dry cleaner and was a member of the Oddfellows Lodge for 50 years.

Survivors include two sons, C.D. Fitzgearld Jr. of Dimmitt and Billy Fitzgearld of Plano; a daughter, Jean Starr of Richardson; two sisters, Leta Belle Marchman of Garland and Donnie Spoonmore of Kingston; seven grandchildren and 10 great-grandchildren.

## Dayton E. Hacker

Dayton E. Hacker, 63, died Aug. 14 in Abilene.

Graveside services were held Aug. 18 at 3 p.m. at Hart Cemetery with Rev. Perry Hunsaker, pastor of First United Methodist Church of Hart, officiating and Vick Reagan assisting. The burial at Hart Cemetery was under the direction of Foskey Funeral Home.

Mr. Hacker was born Dec. 17, 1926 in Farmington, N.M. He was a maintainer driver and lived in Abilene for the last five years after moving from Hart. He married Jewell Vamer on Feb. 4, 1956 in Hart.

Survivors include his wife; his daughter, Beth Reagan of Upland, Calif.; two sons, Dayton Hacker, Jr. and Jimmy, both of Abilene; his mother, Irene Hacker of Deer Island, Ore.; two sisters Erma Vasquez of Hart and Billie Ivey of Deer Island, Ore.; a brother, Leland Hacker of San Antonio; and one grandchild.

## Ruth Womble

Funeral services for Ruth Womble, 81, of Hereford were held Wednesday afternoon in the First United Methodist Church of Here-

ford with Dr. Steve McElroy, pastor, officiating.

Burial was in Hereford's West Park Cemetery under the direction of Gililand-Watson Funeral Home of Hereford.

Mrs. Womble died Monday in Westgate Nursing Home in Hereford after a lengthy illness.

She was born in Arkansas and moved to Hereford in 1930 from Tulia. She married Baker Womble July 27, 1930 in Dimmitt; he died in 1967. She was a member of Hereford's First United Methodist Church.

Survivors include a daughter, Sally Strain of Hereford; and two grandchildren.

## Glen Worsham

Funeral services for Glen Wayne Odell Worsham, 27, of Dimmitt were held Aug. 17 in Thomas Chapel in Midland, with Rev. A.R. McNeil, pastor of the Rose of Sharon Holiness Church of Dimmitt, officiating.

Burial followed in Fairview Cemetery in Midland under the direction of Thomas Funeral Home of Midland.

Mr. Worsham died Aug. 13 in Dimmitt as the result of stab wounds.

Born Dec. 21, 1962 in Muleshoe, Mr. Worsham moved to Midland at an early age, then moved to Dimmitt at the age of 13. He was preceded in death by his father, Jeremiah Worsham, who died in 1981.

He is survived by his wife, Cora Ewing Worsham, and two sons, Glen Wayne Odell Ward and Glen-son Gerome Worsham, all of Dimmitt; his mother, Annie Rezell Hester of Midland; his grandmother, Willie Tubbs of Midland; ten sisters, Willie Cooks, Debra Worsham, Cathy Worsham, Janice Samuels and Lesia Samuels, all of Midland, Frankie Hemphill, Patricia Worsham and Shannon Worsham, all of Odessa, Barbara Green of California and Joyce Davis of Lubbock; five brothers, John Hicks of Odessa, Eddie Hicks and Jimmie Samuels, both of Midland, Jeremiah Worsham Jr. of California and Kenneth Ward of Dimmitt; 22

nieces and 18 nephews; and five brothers-in-law, Richard Hemphill, Matthew Gibson, Bud Davis, Steve Green and Steve Holiday.

Pallbearers were Raymon Reed, Richard Reed, Mark Saddler, Bernard Jameson, Matthew Gibson and Steve Holiday.

## Yearbooks are available today

The 1990 Bobcat Yearbooks will be distributed during registration at Dimmitt High School today from 1 to 4 p.m.

The yearbooks will be distributed from Room 27, Mrs. Ryan's room. You need your receipt if at all possible.

There are approximately 25 extra yearbooks that will be for sale on a first come first served basis. The cost will be \$25 for these books.

There will be no distribution before today at 1 p.m.

## Open forum set Friday

Ralph Harmon from the Texas Dept. of Health, will be at Canterbury Villa Friday at 1:30 p.m. to discuss any concerns family and residents have.

The open forum meeting will be an opportunity to discuss new regulations that will go into effect Oct. 1, which includes removal of all restraints and side rails.

All family members are urged to attend.

## RES plans open house

Richardson Elementary School in Dimmitt will hold a "New Year's Eve" open house from 7 to 8 p.m. Monday on the eve of the new school year.

Parents are encouraged to bring their children and come meet the teachers and view the facilities.

More about

# 1:1

(Continued from Page 1)

main accompanist for the Centennial Chorus are still to be named.

—A Centennial Caravan, which will visit different churches throughout the county on Sunday evenings and perform a program of old-time gospel hymns.

—A Cinco de Mayo celebration next May 5 to call attention to our Hispanic culture.

—A time capsule.

—A poster contest for youngsters.

—A Centennial Quilt project, to be coordinated by the Friendship Quilters Club but open to all individual quilters.

—The planting of Centennial Trees throughout the county during the year. (The flowering crabapple, Bradford pear and red oak have been nominated so far; the choice must be made and the initial supply ordered before the first of the year's two tree-planting seasons.)

—A Centennial Art Project to produce historical paintings that could be displayed throughout the county.

—A Centennial Photography Project, along the lines of "A Day in the Life of Castro County" or "Centennial Seasons," in which camera-wielders throughout the county will shoot and submit photos to go into a special "centennial collage" that can be used in many ways.

—A county-wide July 4 picnic (perhaps along the Running Water Draw at Sunnyside) with a fireworks show that will knock your eyes out.

—A Castro County Centennial Float to be entered in all our local parades as well as those in the surrounding area.

—The design and sale of souvenirs such as T-shirts, commemorative coins, caps, pins, songbooks, etc., to raise money. Each souvenir project will have its own chairman and committee.

We still need ideas for centennial activities involving our youth, schools and churches, plus any other ideas that will help make our centennial celebration either more fun or more meaningful.

And we need to build up our talent list of singers, dancers, players, musicians of all kinds, artists, carpenters, bricklayers, word processors, seamstresses, marketers (you name it, we need it), whom we can call on.

So you can see there's a lot of work to be done and a lot of fun to be had.

Now's the time to volunteer. Or, as they say, you can volunteer now or be drafted later.

If you've seen any project here that you'd like to be involved in, please call the Dimmitt Chamber of Commerce office at 647-2524. Your county centennial needs you.

# Summer Clearance

Take An Extra

# 50% Off

All Yellow Ticket Summer Fashions

Reductions will be taken at the register

Original Price

**ANTHONY'S**

**19<sup>99</sup>**

Yellow Ticket Price

**ANTHONY'S**

**13<sup>99</sup>**

With an EXTRA 50% OFF Taken at the Register

# Only 6<sup>99</sup>

Excludes all denim merchandise.

Sale prices effective through Saturday, Aug. 25

**ANTHONY'S**

We're Good at Making You Look Great!

TODAY'S ASSIGNMENT

## SAVINGS for BACK TO SCHOOL!

 <b>FILLER PAPER</b> 200 Ct. Pkg., \$1.59 Value <b>4 For \$3<sup>00</sup></b>	 <b>THEME BOOKS</b> 70 Ct. Spiral, 99¢ Value <b>3 For \$1<sup>19</sup></b>	 <b>PORTFOLIOS</b> 2 Pocket, 3 Clip, 49¢ Value <b>5 For \$1<sup>00</sup></b>
 <b>YELLOW PENCILS</b> #2, 10 Ct. Pkg. <b>39¢</b>	 <b>AIM TOOTHPASTE</b> 6.4 Oz., Assorted Types Sale Price..... \$1.55 Less Instant On Pack......55 Coupon......55 Less mail in manufacturers Rebate.....\$1.00 Final Cost After Rebate..... <b>FREE</b>	 <b>SCHOOL BOXES</b> Assorted <b>89¢</b>
 <b>PRACTICE WORKBOOKS</b> Preschool, 1st and 2nd Grade, \$1.25 Value <b>3 For \$1<sup>00</sup></b>	 <b>BAUSCH &amp; LOMB</b> Sensitive Eyes Saline Solution 12 oz. <b>\$1<sup>99</sup></b>	 <b>HI-DRI TOWELS</b> <b>4 For \$2</b>
 <b>HEALTH MART ALCOHOL</b> 70% Isopropyl 16 oz. <b>2 For \$1<sup>00</sup></b>	 <b>YES</b> Laundry Detergent 64 Oz. <b>\$1<sup>99</sup></b>	 <b>JERGENS BAR SOAP</b> 3 Oz. Bars, 6 Pk. <b>2 For \$1<sup>98</sup></b>
 <b>HEALTH MART</b> We Treat You Better, So You'll Feel Better.	<b>COLEMAN PHARMACY</b> 647-3151 201 NW 2nd, Dimmitt	<b>SCHOOL SUPPLY LISTS POSTED</b> Good supply of most school supplies at good prices!