

The Winters Enterprise

VOLUME SEVENTY-SEVEN

USPS NO. 687-220

WINTERS, TEXAS 79567, THURSDAY, DECEMBER 17, 1981

PRICE 25 CENTS

NUMBER 41

Local man charged in drug raid



Seizures...

U.S. Customs agents inspect one of the two twin Beech aircraft con-

fiscated in last weekend's drug raid at the Winters Airport. Officers

said that traces of marijuana were found in the plane.

Charges of felony possession of marijuana were filed against three men over the week-end as the result of a joint effort by the Texas Department of Public Safety Narcotic Officers, U.S. Customs, the Runnels County Sheriff's Department, the Winters Police Department and officers from the Texas Alcoholic Beverage Commission.

George Randolph (Randy) Brooks, 48, owner of Brooks Flying Service, was among the three men charged in the raid. Brooks was arrested Monday morning by sheriff's deputy Johnny Wilson at the Winters Airport. Bond for Brooks was set at \$20,000 on the felony possession charge. John Nicols, 38, of Houston and Nelson B. Crawford, 33, of Dayton Ohio were arrested by state and federal officers Friday night at the Winters Airport after the second of two twin-engine airplanes landed. Crawford was said to be the pilot of one of the planes and

SS reps plan December visit

Garland Gregg and John Willis, Social Security representatives for the San Angelo Social Security office, has scheduled their December visit to Winters. They will be at the Housing Project office on Monday, December 28 from 9:30 to 10:30.

Anyone who wants to file a claim for benefits, get information, or transact other business with the Social Security Administration may contact them at this time.



Thanks...

Craig Smith of the Desano Corporation presents a check to Marvin Bedford, representing the Winters Volunteer Fire Depart-

ment to cover the cost of fire fighting materials used in last week's oil well blow out.

Nicols, a passenger. Both men were captured as they fled the plane when it landed.

Department of Public Safety narcotic officers said the investigation into the suspected drug operation began almost a year ago and the investigation is continuing after the arrests over the week-end.

Officers said that several other persons thought to be involved in the marijuana smuggling operation escaped officers at the airport Friday along with what officers think was about 500 pounds of the illegal weed.

The raid got underway about 6:15 p.m. Friday when U.S. Customs air support officers and state narcotic officers followed an airplane to the local airport. About 15 other officers converged on the landing strip along with Runnels County Judge Bill Stultz who issued search warrants for buildings owned or controlled by Brooks Flying Service.

When officers executed the search warrants, about 5 pounds of a substance thought to be marijuana was found. One brick of the weed was found in an old refrigerator being used for storage and another was found behind the spare tire in a vintage '56 Chevrolet parked in the hangar building. Officers also discovered a number of rubber fuel bladders and necessary connections to install the bladders in an airplane to greatly extend its flying range without refueling.

A pickup and trailer, believed used to transport the contraband,

were confiscated along with the vintage automobile. Customs officers said the sides of the covered trailer had been covered and that the trailer was partially loaded with hay that they theorize was used to cover up the illegal cargo.

Radio monitoring equipment capable of receiving state and local police frequencies was also discovered during the search.

Two airplanes, both twin-engine Beechcrafts, were also confiscated by the law enforcement agencies in the raid. Officers said that on one of the planes traces of what was thought to be marijuana were found along with an electronic device to locate "bugs" or electronic surveillance devices.

On the second aircraft, officers found a large stock of electronic equipment including a small

Commissioners have routine meeting

This week's meeting of the Runnels County Commissioner's Court was mostly routine with the approval of bonds for new county employees and approving contracts.

Bonds for new sheriff's deputies Hal Jones and Bobby Salinas were approved by the commissioners as was the bond for Loraine Halfmann, a new deputy in the Tax Assessor-Collector's office.

A request from Highway Patrol Troopers Scott Warren and Tom Barkley for a new radar unit was tabled by the court until after the first of the new year. The commissioners also deferred until next year the appointment of the County Health Officer.

In other business, the county approved a contract with Bob's Tree Service of San Angelo for the trimming of trees on the courthouse square. The contract was approved pending the acceptance of the contract by Bob's Tree Service. The amount of the contract is \$1,320.

A \$15 per month increase in the rent for the tax office building in Winters was agreed to by the commissioners. The rent was increased by the building's owner from \$75 to \$90 per month. County Judge Bill Stultz said the county would pay the rent annually.

A supplemental contract with the Area Agency on Aging was approved by the county. The Agency on Aging is administered through the West Central Texas Council of Governments based in Abilene.

Before handling routine items, the commissioners approved the county's method of payment to the Runnels County Tax Appraisal District. The county will pay it's \$66,577.53 on a quarterly basis.



Loaded...

This aircraft was loaded with electrical appliances thought to be

used as trade goods for illegal mari-

juaana in Mexico. Both of the planes were confiscated by state and federal officials.

refrigerator, a microwave oven, and smaller appliances and radios. Customs agents said the merchandise was very likely being purchased in the United States and then taken to Mexico where it would be traded for marijuana. Both airplanes had the necessary connections to enable them to use the fuel bladders that were found during the search.

U.S. Customs agents said that they had followed the aircraft by both radar and airplane from Laredo where they crossed the Mexican border to Winters where they theorize the planes would be pulled into a hangar while the contraband was loaded onto vehicles to haul the weed to other locations or points of distribution.

Officers said that both aircraft had been recently repainted and on one of the planes the registration number had been altered. The officers also said that both planes had been repaired during the past year for damages that could have been received from brush or trees on the short, dirt airstrips in Mexico.

The two airplanes were flown to

School to dismiss for Christmas holiday

Winters public schools will be dismissed at 2:30 p.m., Tuesday, December 22 for the Christmas holidays. School will resume on Monday, January 4.

Abilene by officers Saturday and the planes will remain impounded. Both the pickup and trailer and the car were taken to Ballinger and are impounded there.

Officers from both the Department of Public Safety and U.S. Customs told *The Enterprise* that the investigation into the marijuana trafficking through the Winters Airport would continue and that there was the possibility that more arrests would be made

and that other evidence may be presented to a grand jury for possible indictment. The officers said the operation here appeared to be a major distribution point and that many thousands of dollars worth of illegal drugs may have passed through the local airport.

Spokesmen in the Runnels County Sheriff's Department said that all three men, Brooks, Crawford, and Nicols were released from jail Monday afternoon on \$20,000 bond each.

Ballinger stores lose \$8,000 in hot check spree

A number of Ballinger merchants apparently were swindled out of almost \$8,000 in merchandise and cash last week by a man writing worthless checks according to sheriff's deputy Odell Denton.

The checks, which began appearing Wednesday were allegedly written by a man who had opened an account at a Ballinger bank December 2 with just a small amount of money. Deputy Denton said that felony theft by check warrants had been issued for a man identified as Max Reynolds. The deputy said that Reynolds was about 50 years old and was thought to be from Brownwood.

Among the items purchased by the man were a 1980 Chevrolet sta-

tion wagon, several pieces of luggage, a rifle and ammunition, groceries from two stores, a television set, camera, saddle, and gasoline.

The merchants involved included Wright's Motors, Black's, Gate No. 1 Western Wear, Western Auto, Super Duper, Higginbotham's, Keel Drug, Dallinger Hardware, Piggly Wiggly, and Broadway Texaco, all in Ballinger.

Deputy Denton said that a description of the man along with warrant information had been entered into both the state and national law enforcement computers and that Brown County authorities also are interested in finding the man to face similar charges there.



Marijuana transport...

This pickup and trailer were confiscated by authorities at Brooks Flying Service during the raid last

Friday evening. Officers said the side panels on the trailer were covered and that the trailer may

have been used to haul the illegal weed.

MEMBER 1981
TEXAS PRESS ASSOCIATION

The Winters Enterprise

Published by RyKel Corporation
 (USPS 687-220)
 915/754-5221 P. O. Box 37 Winters, Texas 79567

RICHARD C. THOMAS, Editor-Publisher
 YVONNE THOMAS, Asst. Publisher
 KERRY CRAIG, News Editor
 LOICE OSBORN, Advertising Manager
 SANDRA RADFORD, Circulation Manager
 KELLEY CRAIG, Staff Writer, Photographer

Entered At Post Office, Winters, Texas 79567,
 As Second-Class Matter.

SUBSCRIPTION RATES

In Runnels County, 1 Year \$ 6.00
 In Other Texas Counties, 1 Year \$ 8.00
 Outside Texas, 1 Year \$10.00

Any erroneous reflection upon the character, standing or reputation of any person, firm or corporation which may appear in the columns of this newspaper, will be gladly corrected upon due notice of same being given to the editor in writing personally at this office.



Receives check...

RC Kurtz, chairman of the Buddy Poppy Sale of the Winters Veterans of Foreign Wars Post 9193 and its Ladies Auxiliary gives a check to Gloria

Isaacs, president of the Winters Future Homemakers of America in appreciation of the FHA help in the recent Buddy Poppy Sale.

Nursing Home News

This month is known throughout the world as the month of giving, because of the celebration of the birthday of Jesus, our Lord and Saviour. This is good; however, I would like to think of how much better it would be if the world would strive to retain that spirit on an everyday basis, not because of our Lord's birthday but more so because of the life he lived and died and lives again. That example of giving or serving others is the Life we are to strive for and obtain, according to his words. Our prayer is that we never fail to strive for it and our hope is that we obtain it.

At this time I feel it would be appropriate to express our gratitude towards those who have displayed this, towards giving and serving others, here at the Nursing Home. Without your help and volunteering your time, life wouldn't be to our residents, as full. So, a GREAT BIG THANKS! to all of you who have and are sharing with us. This month our birthday party for the residents will be held on the 21st from 3:30 p.m. til 4:30 p.m. Those having birthdays are Thelma Hensley, Dec. 1; Jim Mackey, Dec. 5; Bob Blanchett, Dec. 20; Pearlle Abbot, Dec. 21; Mike Krause, Dec. 21; and Kye Hudson, Dec. 22. The ladies from the Rebecca Sunday School Class will have charge of the program and refreshments. Friends and relatives are

invited. The preschoolers from the First Baptist Church sang carols to us on Sunday morning, the 12th. Children always lighten things up around here.

Thank you, Dr. and Mrs. Y. K. Lee for the case of bananas, the residents just love them. Thank you to the Sew and Sew Club in Wingate for supplying a box of Christmas Kleenex to each of our residents.

We would like to welcome the following new residents; Mrs. Julia Hinds, Mrs. Vashti Waddell, Mrs. Myrtle Smith, and Mr. Otto Kelly. It's always a pleasure to receive new members to the family.

Our deepest sympathy to the families of Mrs. Laura Turk and Amanda "Granny" Waldrop. These two ladies took a part of



NEWCOMERS

Tyson Nathaniel Adami
 Mr. and Mrs. Charles Adami of San Angelo would like to announce the birth of their second son, Tyson Nathaniel, born on November 25.

Tyson and his brother, Evan, are the great-grandsons of Mrs. Charles (Nora) Adami of Winters.

Lance Michael Berry
 Mike and Judy Berry of Wichita Falls are the proud parents of a son, Lance Michael, born December 5 in Wichita Falls. The baby weighed 8 1/4 lbs.

Grandparents are Mrs. M. H. Hogan of Winters and Mr. and Mrs. H. I. Berry of Iowa Park.

our life with them when they went on to their eternal reward this December, 1981.

Mrs. Ava Crawford was able to go home this past week. Mrs. Crawford, we sure will miss you and hope that you will come to see us real soon.

—Ann Smith
 —Social Services
 —Senior Citizens Nursing Home

"Patience is bitter, but its fruit is sweet."
 French Proverb



A rare South American bird, the hoatzin, has claws on its wings as well as on its feet when it's young, help it to climb about in the trees.

"NERVE DEAFNESS" CAN BE HELPED

If you, or a loved one has trouble understanding when the family gets together for the holidays . . . come in and ask about the latest in ALL IN THE EAR HEARING SYSTEMS
 Get Ready For The Holidays!

Housing Authority of the City of Winters

December 18
9 a.m. p 12 noon

Texas State Hearing Aid Center
 4201A N. 1st, Abilene, Tx. 673-4989

DECK THE HALLS WITH THESE

GOIFTS

For Every Member Of The Family

Music Boxes
 Pewter & Brass

Gun Cabinets

Wall Units

Desks

Recliners

Game Tables

Free Gift Wrapping

SPILL FURNITURE

Phone 754-4511 131 South Main

CAS CUSTOM AG SERVICE, INC.

P.O. Box 97 Loraine, Texas (915) 737-2274

COMPLETE DELINTING SERVICE

- *Modern Efficient Plant
- *Seed Treatments Disyston Or Go Better Vitavax Or Demosan Fertilizer
- *Bag Storage (Bonded & Insured)

Phone for Appointment or Special Services

- *Lab Services
- *Concerned, Experienced Seedsmen Who Realize Your Livelihood Is In Our Hands.

1-20 & FM 644

WE APPRECIATE YOUR BUSINESS

Tom Eaves, Mgr. Glenn Reynolds, Sales Rep.
 Ted Petty, Plant Supt. Ann Hallmark & Gail Albin, Office

no finance charges for 11 months

Buy one of our new Case farm tractors now . . . finance it through J I Case Credit Corporation . . . and finance charges will be waived for eleven (11) months from date of purchase.

OR choose a Case cash rebate . . .

If you would rather have a cash rebate and you buy any of our new Case farm tractors listed on the chart . . . Case will send you a check for the dollar amount shown on the chart for the model you buy. Rebate may be applied toward your down payment. NOTE: Government Agencies/Departments do not qualify for rebates.

Eligible Model	Cash Rebate
1190, 1290, 1390, 1490, 1690	\$1000
2090, 2290	\$2000
2390, 2590	\$3000
4490, 4690, 4890	\$4000

Waiver of finance charges on used farm tractors.
 Buy one of our used farm tractors, any make . . . finance it through J I Case Credit Corporation . . . and finance charges will be waived date of purchase until June 1, 1982.

Offers valid November 1 thru November 30, 1981

WINTERS FARM EQUIPMENT, INC.

Purchase date extended thru December 31, 1981



Christmas SPECIALS!

Savings In Time For Your Holiday Shopping Include . . .

HANG 10 Junior Separates 25% off

Sheer Gown & Robe Sets & Brightly Colored Fleece Robes

ALL 10% off

Coveralls & Overalls In Denim & Cordory 1/2-Price

100% WOOL COATS By Fashion Bilt 40% off

Save \$5.00 on CHIC Jeans

Large Selection of Dresses, Blouses and Slacks for Your Shopping Needs

We care about you and want to be of service to you in every way possible. Our alterations and beautiful gift wrap is just one way of saying Thank You to our preferred customers.

Carolyn Gully & Her Staff Wish You A Wonderful Holiday Season!

The Fashion Shop

"Fashion Is Our Business"

Dear Sa
 I woul
 Hazzard
 shotgun,
 motorcy

Dear Sa
 I wan
 and no
 been a r

Dear Sa
 I wan
 hungry
 game,
 change
 piano, a
 pull out
 saw on
 been go
 all of th

Dear Sa
 Peace
 minebil
 and a b
 give me

Dear Sa
 I wan
 and som
 and a to

Dear Sa
 Pleas
 cart an
 bike an
 trampo
 and a d
 and a
 cycle t
 short a
 some p
 and a b
 nario a
 comb a
 a airgu
 table a
 a cot.

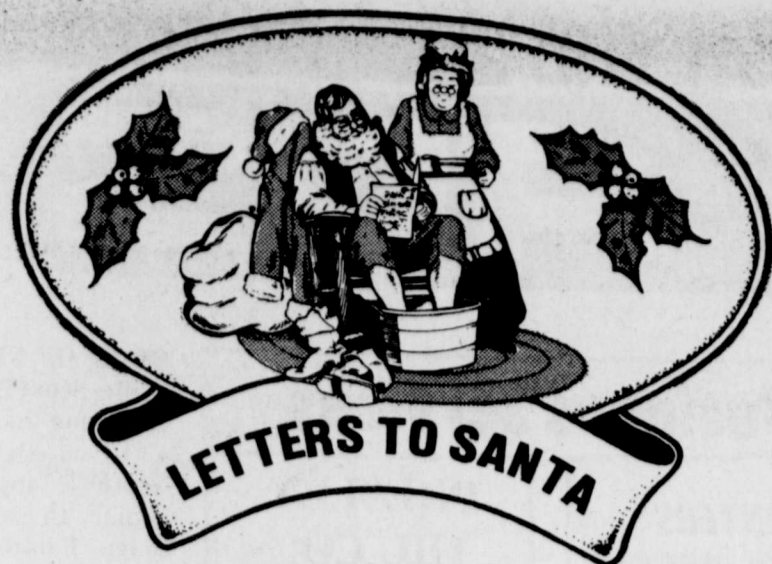

Dear Santa,
I would like a Dukes of Hazzard race car set, calf, shotgun, chicken, and a motorcycle.

Thank you,
Ronny Willborn

Dear Santa,
I want a tippy toe doll and nothing else. I've been a real good girl.

Love,
Dusty Gray
Age 3

Dear Santa,
I want a fire truck, a hungry hungry Hippo game, a truck I can change the tires on, and a piano, and a truck I can pull out of the mud like I saw on T.V. I think I've been good enough to get all of this.

Love,
Chris Harrison
Age 5

Dear Santa Clase,
Pease get me a goear, minebike and a football and a bike and a gun and give me corvit, jet bote.

Timothy Torres

Dear Santa,
I want a tippy-toe doll and some more baby dolls and a teddy bear.

Love,
Staci Harrison
Age 3

Dear Santa Clase,
Please bring me a go cart and a minebike and a bike and a football and a trampolen and a key car and a duke car and a coat and a hose and a motorcycle that goes 80 and a short and some sokes and some pans and play gun and a bebe gun and a borano and a pump and a comb and a basketball and a airgun and a hetr and a table and some games and a cot.

Sign,
Raul Rodriguez

Dear Santa,
I want a electronic foot-ball game and boxing gloves and puchingbag.

Thanks,
Buddy Jim Miller

Hi, Santa Claus,
I love you Santa. I am 4 years old. I have been a pretty good girl all year. If you have the time I would like you to bring me: Tippy Toes, and a real live horse that I can ride, some Barbie make-up, a stove that bakes cakes, a new housecoat and house shoes, strawberry short-cake gown, a western suit and hat, and a little bit of fruit and candy. We will have a snack for you if you are hungry. If you have the time please leave something for my 3 brothers, too!

Love,
Alicia Kaye Smith

Dear Santa,
I want a gocart and a motorcycle and a speedboat and a 4-10 and a trampolen and a trazam and a whit fright liner and a skiboat.

Temple

Dear Santa,
I want a motor cycle just like my daddys. I like you and hope you bring me some more toys.

Love,
Ross Alan Howard
Age 2

Dear Santa,
Would you please bring me some blocks, a truck, a Snoopy dog, some cowboy boots, and a few new cloths? I will leave the door open for you. I will be a good boy. I love you, Santa.

Love,
Tony Cranford

Dear Santa,
I want a trainset and a 4-10. Have Merry Christmas.

Christopher L. Matthews

Dear Santa,
I have tried real hard to be good all year, hope you didn't see the times I forgot. Would you please bring me a big bolt construction set and an airplane. Thank you for the candy and coloring book you gave me when I sat in your lap. Please bring Samson and Rusty a little stocking. I will leave you some cookies in my stocking so you want get hungry. I love you alot.

Love,
John McGallian Jr.
Age 5

Dear Santa Claus,
I am a 4 year old little boy. I have been fairly good but will try to be better. I would like you to bring me a talking Mickey Mouse, a whistle, a choo choo train, a truck, a car, some pajamas, a cowboy suit and hat, some new shoes, and some fruit and candy. I love you. I will be waiting on you.

Love,
Christopher Cranford

Dear Santa,
I want a T.V. an a box of sugar cubes and a dolly stroller and a toy shelf. Please, Santa bring my sister Callie some Loc Blocks.

Love,
Rachel Wilshire
Age 3

Dear Santa,
I want handcuffs, gocart and a handchief, clip, football, Dukes of Hazzard, barn buster and key car.

John Austin

Dear Santa,
I have been a good boy. I sure would like a coke machine and a guitar.

I'll write another letter later to tell you what my brother Kenny wants.

Love,
Cody Whittenburg
Age 4

Dear Santa,
I want some toys and a teddy bear. I sure like you.

Love,
Jason Mitchell
Age 4

Dear Santa,
I want a gocart and a bow and arrow and a trampoline and a corrvette and a airplane. And do not get a cold and tell Rudolph hi for me. And be quite Christmas evel!

Brandon Boles

Dear Santa,
I like you and I want some race cars. Please bring my sister something.

Love,
Michael Mostad
Age 4

Dear Santa Clase,
Please give me a football and a minebike and a gocart and a bike and a motorcycle and a gun and a rifle gun.

Johnny Rodriguez

Dear Santa,
I would like a go-cart and I would like a watch to and a motorcycle. Hope you have safe trip.

Timmy Neal

Dear Santa Clues
I want a three wheeler, and I will lik a pair of boots. and a cowboy suit.

from Gene

Dear Santa,
I want a fire truck and I know I am getting a piano because I want one. I like you Santa and I sat in your lap.

Love,
Stephen Herrington
Age 3

Dear Santa,
I want a new go-cart. I want a motorcycle. I want a truck.

Matthew Briley

Dear Santa,
I want a Dukes of Haserd racing set and I want a bowling watch too.

from Micheal Rodriguez

Dear Santa
I sat in your lap Saturday and told you I wanted a tippy-toe doll. Thank you for the candy and I like chewing gum too.

Love,
Laci Torres
Age 3

Dear Santa,
I wish I had a bebe gun. Dear Santa, I wish I had a go Kart.

Frum Michael Bullard

Dear Santa,
For Chirstmas I would like a digital dar-devil, some atari cartidges, dukes of hazzard race car set, a big track trailer, H.O. train, and my go-cart fixed.

Your friend,
Dan Killough

Dear Santa,
I want star war men and ships. I like you. I am going to leave you some cookies and milk.

Love,
Corey Radford
Age 3

Miss Rios, Mr. Tischler wed in December 5 ceremony

Mary Rios, daughter of Mr. and Mrs. Lupe Garza of Runge, and Douglas Kent Tischler, son of Mr. and Mrs. Bennett Tischler of Winters, were married at 7 p.m. December 5 at the St. John's Lutheran Church, with the Rev. Lawrence Keene, officiating.

White pom mums decorated the altar of the church during the single ring ceremony.

Mrs. Ernestine Geistman served as organist. Candlelighter was Casey Boggs of Leuders. Flower girl was Tammy Dry of Winters, and ring bearer was Christopher Dry of Winters.

Rick Dry of Winters served as usher. The bride, given in marriage by Craig Glenn, wore a floor-length white satin gown with tiered lace overlay and train. She carried a bouquet of white daisies embedded with multicolor beads and blue ribbons.

Maid of honor, Eva Glenn of Plainview, and bridesmaids, Linda Rios of Kress and Rosie Boggs of Leuders, wore floor length blue gowns with lace overlays, and carried white roses with blue ribbons.

Best man was Michael Tischler of San Angelo.

Dear Santa,
I wish I had a cris cross crash race track. Remember all the other boys and girls and A Merry Christmas to you, Santa.

From J'Dan Miller

Dear Santa,
I want a go-cart and Dukes of Hazzard race set and a team America.

Billy

Dear Santa,
I have never seen you but I am going to hide under the divan and get out and talk to you. Then I am going to tell you I wnat a motor cycle, gloves and a helmet and my own T.V. I sure hope you come.

Love,
Robert Matthew Bedford
Age 4

Dear Santa,
I would like a gocart and a bicyle and a pair of boots and I wear a size 2 1/2 D and a three wheeler.

Love,
Lance Richard Bellis

Dear Santa,
I wish that I had a Bike. Dear Santa, I wish that I had a Flag. Dear Santa, I wish that I had a pool table.

From Eric

Dear Santa,
I want a doll and a coke machine and I told you everything else I wanted when I sat on your lap.

Love,
Gayla Clough
Age 4

'Tis the season to send our FTD Holiday Glow Bouquets

Light up the holidays for someone special. Our FTD Holiday Glow "Twin Candle" Bouquet makes a perfect centerpiece.

Our FTD "Single Candle" is just right for those other special places in a home



Register For FREE Gift!

WINTERS FLOWER SHOP

Helping you say it right.

ATTENTION LADIES! HURRY FOR BEST SELECTIONS! JONI-LYN BLOUSE FACTORY

In Bronte Is Up For Saie

Giant Liquidation Sale of entire inventory — Everything drastically reduced — Almost all items sold at wholesale or below

- ★ All Blouses (Size 30-44) — \$2⁰⁰ - \$11⁰⁰
- ★ Pants (Sizes 8-22) — \$6⁹⁹
- ★ Pant Suits (Long & Short Sleeve) — \$12⁰⁰ - \$13⁰⁰
- ★ Wrap Around Skirts — \$10⁰⁰
- ★ Springs Mills Broad Cloth (Solid) (65% Polyester, 35% Combed Cotton) yd. \$1¹⁰
- ★ Springs Mills Broad Cloth (Prints) (65% Polyester, 35% Combed Cotton) yd. \$1¹⁵
- ★ Also suede, washable wool — Corduroy, Knits on sale
- ★ Notions & Zippers, Buttons, Threads, Hangers

ALL SALES FINAL

JONI-LYN BLOUSE FACTORY

121 N. State Bronte, Tx. 76933 (915)473-6621

Open Monday Thru Saturday, 8 to 6: Open Sundays, 1 to 5

3-oz. LIPTON INSTANT TEA \$2⁰⁹

Double Green Stamps Every Wednesday

LIGHT CRUST POUCH MIXES 5/\$1

SUNBEAM COOKIES Buy 1, Get 1 Free

Effective Dates: Wednesday, Dec. 16 thru Thursday, Dec. 24

Piggly Wiggly

WE HAVE THE LARGEST SELECTION OF HAMS, TURKEYS AND CHRISTMAS FIXING'S IN TOWN



84-oz. DETERGENT CHEER \$3²⁹

48-oz. LOU ANN Vegetable Oil \$1⁸⁹

Double Manufacturers Coupons on Saturdays

10-oz. CRACKER JACKS 3/\$1

50-oz. DISH DETERGENT CASCADE \$1⁹⁹

HAPPY HOLIDAY PARTNER

We've wrangled up a corral of good values to add to our holiday wishes, for all our valued customers. Hope you rope yourselves the best holiday ever!

All Outer Wear **15% off**

All Men's & Ladies Boots **10% off**

See The New **KENNY ROGERS Ladies Jeans**

O'Neal's WESTERN WEAR
204 E. Dale Winters, TX

"No one asks about the pedigree of a good man." Spanish Proverb

You've earned your Wings!

FOR RUGGED PULL-ON RED WINGS MADE FOR ON-THE-JOB COMFORT

\$49⁹⁵

#1177

12" full-grain oil-tanned leather with western heel.

#1155

Red Wings
HEIDENHEIMER'S

BUY, SELL, TRADE OR RENT THROUGH THE CLASSIFIED ADS

CLASSIFIED RATES

CASH
Minimum—\$2.50, 1 time 20 words; 8 cents per word for over 20 words.

CHARGED
Minimum—\$3.00, first insertion, \$2.50 per insertion thereafter. (8 cents per word over 20 words.)

LEGAL PUBLIC NOTICES
Regular Classified Ad Rates will apply for all Legal Public Notices.

DEADLINE FOR ALL ADS
12:00 noon Tuesday week of publication.

FLOWERS

FLOWERS for all occasions. Orders wired anywhere, any time. Bonded FTD, Florafax florist. Mayme Little, Winters Flower Shop. Dial 754-4568. ffc

BLOSSOM SHOP: Bonded FTD, AFS and Florafax florists. Flowers for all occasions. Flowers wired anywhere. Phone 754-5311. Butch and Darlene Grant, owners. 4-ffc

FOR SALE

FOR SALE: Farm Equipment: One 18 1/2 ft. Bush Hog Offset; two Case 4-Bottom, 16-inch moldboards; two 4-Row John Deere Cultivators; two 3-bottom rear mount bedders; one 5-bottom John Deere front mount bedder; and one 4-row Oliver Planter. Call 754-5086 or 754-4677. 37-ffc

CLASSIC '52 Allstate. Original 6-cyl. engine, overdrive, complete original Allstate equipment, including spotlight and windshield washers. Real collector's item and restorable, \$1,500. Call 365-5357. 39-5tp

FOR SALE: Records and tapes at RICE GROCERY. 201 E. Truitt. 39-4tc

THE DIVERSITY CLUB is selling Corsicana Fruit Cakes. Contact any club member, or call Mrs. Frank Brown, 754-4185, or Mrs. Earl Roach, 754-4861. 40-2tc

FREE COFFEE

For The Ladies while shopping **Dec. 22 Only** at **THE BAKERY** 115 N. Main

FIREWORKS: Fireworks for all ages — Opens Dec. 20 thru Jan. 1. Old Wingate Hwy 53. Thelma Hoppe. 41-2tp

FOR SALE: 1 used gas range. HIGGINBOTHAM HARDWARE, Winters. 41-1tc

REAL ESTATE

ATTRACTIVE yard, 3BR, 2 bath, spacious utility room, den w/franklin stove, large workshop, greenhouse, gas light in yard.

REDUCED — White brick 3BR, 2 bath, well/pump, fireplace on corner lot.

ON MAIN STREET — 2BR, Lr, large lot.

COZY FIREPLACE, 3BR, 2 bath, central h/a, pecan trees.

GOOD INVESTMENT — trailer park w/9 spaces, 2BR house with fruit and pecan trees.

NEAT 2BR, 1 bath, recently painted and workshop in back.

CORNER CIRCLE DRIVE beautiful 3BR, 2 bath, central h/a, carpet, and double garage.

LOVELY BRICK — 4BR, 3 bath and all amenities.

ACREAGE FOR SALE: Please call.

CALL ABOUT OTHER LISTINGS

STRICKLAND REAL ESTATE

158 North Main 754-5218 Winters, Texas

FOR SALE

GOVERNMENT SURPLUS CARS AND TRUCKS NOW AVAILABLE through government sales, under \$300.00. Call 1-714/569-0241 for your directory on how to purchase. Open 24 hours. 3tp

RAILROAD CROSSIES for sale: 1 tie, or by the truckload (420 ties). Will deliver. 2874 N. Pine, Abilene. (915) 673-9491, or call 754-4680. 41-2tc

Put Your Old Furniture or What Nots on consignment. Free drawing to be held December 22. **A & Z TRADING POST** 125 N. Main

REAL ESTATE

HOUSE FOR SALE: 2-Bedroom with lot on Melwood. \$4,000.00 or will carry the note at 10% interest. Call (915) 928-5685 — if no answer, keep trying. 40-2tp

FOR RENT

YATES TRAILER COURT. Park by the night, week, or all times. East Dale. Call 754-4369. 11-ffc

ROOMS FOR RENT: Low monthly rates. Rock Hotel, 754-4937. 40-6tp

FOR RENT: 2BR mobil home, furnished. Halley Sims, 1010 State Street, 754-4883. 39-ffc

PROFESSIONAL OFFICES FOR LEASE: Ideal for Lawyer, Accountant, Oil Company or other professionals. Excellent location on main intersection in Winters. Parking included. For information phone Marvin Jones at (915) 754-5111 or (915) 754-5406. 39-4tc

HELP WANTED

HELP WANTED: Applications being taken for men to deliver Petroleum Products and do other related duties. Must be Honest, Dependable, Area & People important. Excellent Hospitalization and Life Insurance Benefits. Inquire at Bob Loyd LP Gas Co., 104 E. Parsonage St., or call 754-4555 days or 754-4146 nights. 26-ffc

NEED A LADY to stay during the daytime with Mrs. Waddell while she is recuperating from surgery. Call Spec Robinson, 754-5310, Winters, Tx. 38-ffc

HELP WANTED: Experienced station and tire man. Apply in person at Hoppe Texaco Service Station. 39-ffc

HELP WANTED

WE ARE NOW TAKING APPLICATIONS for office clerk. Must be good typist, able to work with office machines. Will involve some radio dispatching. Excellent benefits. **POOL WELL SERVICING**, Hwy. 53 West. 40-2tc

EMPLOYMENT OPPORTUNITY: City of Winters has opening for Utility Office Clerk. Typing skills and working knowledge of other office equipment needed. Must work well with the general public. Excellent benefits and pleasant working conditions. For more information, contact City Administrator, City Hall, 310 S. Main St., Winters, Tx. 41-1tc

WORK WANTED

WORK WANTED: Expert sheetrocking, paneling, general repairs, painting, roofing, sidewalks, curbs and porches poured. Also other cement work done. All work done at very reasonable prices. Call D & V Repairs, 754-5186. 35-ffc

WOULD LIKE TO BABYSIT in my home for working parents and busy mothers. Call Debbie Ballard at 754-4814. Dependable. 37-ffc

WANTED

WANTED — Scrap iron, cables, metals. Ballinger Salvage Company. ffc

MISCELLANEOUS

COMPLETE BACKHOE SERVICE. Approved septic systems installed. K.W. Cook, 754-4719. 37-ffc

ALL KINDS OF DIRT WORK. ROY CALCOTE & SONS DIRT WORK. Dozer, backhoe, loader and dump trucks. Have yard dirt in stock for quick delivery. Call 767-3241 or, if no answer, 754-4995. 9-ffc

TIME TO RE-POT. We have a new shipment of Carl Pool Potting Soil. Also Carl Pool Magic Grow plant food. Winters Flower Shop. 1-ffc

I WILL BUY Your Silver Coins, other coins and paper money. Highest prices paid for rare and choice items. **FLOYD SIMS** 754-4224 or 754-4883

DIRT HAULING, general backhoe service. Johnnie Pritchard. Call 743-8115 or 754-5065. 39-ffc

KIDNEY DANGER SIGNS — BACKACHE Getting up nights, smarting, leg pains may show need for a gentle aid to kidney function. **FLUSH** kidneys. REGULATE passage with BUKETS 3-tablet-a-day treatment. Feel GOOD again in 12 hours or your 69¢ back at any drug counter. NOW at MAIN DRUG. 39-ffc

WINTERS FUNERAL HOME

Insurance and Markers
24-Hour Service
754-4529

HELP A LIFE WITH HOPE!

The Memorial Program of the **AMERICAN CANCER SOCIETY**

Margaret Bell
Memorial Chairman
P.O. Box 521
Winters, Tx. 79567

Superior Muffler

Mufflers
Tailpipes
Exhausts
Custom Dual Exhausts
JOHNNY'S SHELL STA.

301 South Main
Phone 915-754-4040
Closed on Saturday

Szalchsue Electric Co.
Oil Field, Commercial & Residential Wiring
Air Conditioning Sales & Service
Authorized Dealer for:
GE - GIBSON - ROPER - FRIEDRICH
Phone 754-5115 • P.O. Box 307 • Winters, Texas 79567

Have You Shopped **RICE GROCERY** Lately?
Specials Everyday
211 East Truitt
Monday Thru Saturday
7:30 a.m. - 7:30 p.m.

MISCELLANEOUS

WESTERN MATTRESS CO. Bi-weekly sales and service. New or renovated. Complete bedding. Phone 754-4558. 33-ffc

PIANO TUNING and repair. 25 years experience. All work guaranteed. Ben G. Arnold, Robert Lee, Texas. Phone 453-2361. Call day or night. ffc

SAW SHARPENING; also scissors, mower blades and hand tools. Complete service. Call or see Bob at Foxworth-Galbraith Lumber Co. 29-ffc

AMWAY® products mean quality — and personal service. Try us and see. Phone 723-2452, Carolyn Kraatz. 30-ffc

NOTICE

"Sealed bids will be received in the office of the State Purchasing and General Services Commission, Centralized Services Building, 1711 San Jacinto, Austin, Texas, covering the proposed lease of space located in the City of Winters, Texas.

TEXAS DEPARTMENT OF HEALTH
LEASE NO. HEA-3527-E-WINTERS
450 SQ. FT.
OFFICE/EXAM SPACE
For information, please contact the Lease Office, State Purchasing and General Services Commission, P.O. Box 13047, Austin, Texas 78711. (512) 475-2153." (December 17, 1981)

CARD OF THANKS

We wish to express our thanks to all our friends who were so thoughtful during our time of sorrow. We will always be grateful to those who sent food, flowers, memorials and each act of kindness shown to us.

A special thanks to the staff of the Senior Citizen Nursing Home, North Runnels Hospital, Dr. W. J. Lee for their care of Granny Waldrop. Thank you, Bro. Thomas and Bro. Hagood for your words of comfort. —The family of Amanda (Granny) Waldrop

Business Services

WINTERS SHEET METAL & PLUMBING WORKS
Plumbing, Heating & Cooling
215 W. Dale
Phone: 754-4343

PRESLEY OIL CO.
Exxon Distributors
All Major Brands of Oil
Delivery For
Gasoline & Diesel Fuel
Phone: 754-4218
1015 N. Main
Ronald Presley
Joe Pritchard

Mansell Bros.
Ballinger-Winters
"Your Authorized John Deere Dealer"
Ballinger 365-3011
Winters 754-4027
Parts & Service
Complete Shop Facilities
HWY. 53 WEST

RCA TV
Authorized Dealer
WE SERVICE ALL MAKES
SALES & SERVICE
BARNES RADIO-TV
754-1223 135 N. Main

Dan's Shoppe of Upholstery
Drapery & Upholstery Fabrics
Mini Blinds — Woven Woods
Custom Drapes
Free Estimates
Free Pickup & Delivery
101 S. Main
Winters, Texas
Dan Smith, Owner

B's Oil Field Construction Co.
General Roustabout
Pumping Unit Repair and Inst.
Tank Battery Hook-up
L.B. Shifflett
P.O. Box 852
Winters, Tx. 79567
(915) 754-4672

CARD OF THANKS

We would like to express our thanks to Dr. C. T. Rives, Dr. Y. K. Lee, North Runnels Hospital, Senior Citizens Nursing Home, Pastor Keene and all of our friends and neighbors for the flowers, memorials, food, kind words, deeds and prayers. We are very appreciative to all of you.

—The families of Mrs. Otto 'Laura' Turk

Ella Mentry

HOW MANY INCHES OF SNOW DOES IT TAKE TO EQUAL AN INCH OF RAIN?



None To Equal OUR HOMEOWNERS POLICY For SAVINGS And GREATEST PROTECTION AGAINST MANY HAZARDS OF NATURE, THEFT, LIABILITY, Without An Inch Of COSTLY OVERLAPS! (It Takes 10 Inches Of Snow)

BEDFORD-NORMAN INSURANCE
GEORGE MOSTAD
754-4915 Winters

PUBLIC NOTICE

In compliance with Sec. 43(a) of Art. 1446c, V.A.C.S., West Texas Utilities Company hereby publishes NOTICE that it has filed, on November 25, 1981, its statement of intent to make changes in its rates charged for electricity and services sold and rendered inside and outside municipal jurisdictions, such proposed changes to be effective January 1, 1982. Such Statement of Intent includes the proposed revisions, tariffs and schedules, and a statement specifying in detail each proposed change, the effect the proposed change is expected to have on the revenues of the Company, and the classes and numbers of utility customers affected. Gross revenues are expected to be increased 15.4 per cent over adjusted test year revenues by the new rates. Statements of intent were filed with the Public Utility Commission of Texas and with the following municipalities:

Abilene	Hawley	Quitaque
Alpine	Hedley	Rankin
Anson	Impact	Rising Star
Aspermont	Iran	Roaring Springs
Baird	Jayton	Rochester
Balmorhea	Junction	Rule
Ballinger	Knox City	San Angelo
Benjamin	Lawn	Santa Anna
Big Lake	Lueders	Shamrock
Blackwell	Marfa	Sonora
Bronte	McCamey	Spur
Buffalo Gap	Melvin	Stamford
Childress	Memphis	Sterling City
Cisco	Menard	Talpa
Clarendon	Merkel	Throckmorton
Clyde	Mertzon	Trent
Crowell	Miles	Turkey
Dodson	Moran	Tuscola
Eden	Munday	Tye
Eldorado	O'Brien	Valentine
Estelline	Paducah	Weinert
Goree	Paint Rock	Wellington
Hamlin	Presidio	Winters
Haskell	Putnam	Woodson
	Quannah	

Areas affected by the filing with the Public Utility Commission of Texas are in the following:

Albany	Lakeview	Roby
Chillicothe	Matador	Rotan
Dickens	Robert Lee	
Baylor		Pecos
Brewster	Gillespie	Presidio
Briscoe	Hall	Reagan
Brown	Hardeman	Reeves
Callahan	Haskell	Runnels
Childress	Irion	Schleicher
Coke	Jeff Davis	Shackelford
Coleman	Jones	Stephens
Collingsworth	Kent	Sterling
Concho	Kimble	Stonewall
Cottle	King	Sutton
Crane	Knox	Taylor
Crockett	Mason	Throckmorton
Dickens	McCulloch	Tom Green
Donley	Menard	Upton
Eastland	Motley	Wheeler
Edwards	Nolan	Wilbarger
Fisher		

The Holloway's wish to extend their warmest thanks to all of their customers who have patronized **Holloway's Florist and The Bar-B-Q Barn**. We still have Poinsettias, Christmas Cactus, and Arrangements.

We Wish Everyone A Very Merry Christmas And A Happy New Year

BURGER HUT
201 E. FM 53
OPEN
11 a.m. - 2 p.m.
Monday thru Friday
754-4181

Poe's Corner

BY CHARLES POE

Path of Faith

Fred Thomas, pastor of the First Baptist Church, was honored recently by the membership, in recognition of his 40 years in the ministry.

At an after church fellowship, he was presented a watch, and a special cake was baked for the occasion. The icing depicted a road lined with trees, flowers, and a few rocks, with the caption, "Path of Faith."

The decision to become a minister was made one Sunday night at his home church in Bonham, when he was seventeen years old, said Brother Thomas. "No one expected me to be a preacher, no one in our family had been in the ministry. I was too shy to speak in public, and I had an inferiority complex."

His father said, "Fred, if you are going to be a preacher, be a good one." And, he has tried to follow his father's admonition.

The first church he pastored was the Philadelphia Baptist, a rural church, southeast of Bonham. It was a one room auditorium with curtains dividing the class rooms. They had open assembly and Fred led the singing. He had announced a hymn when a lady came down to about the third row. She had made the turn into the pew, when her underwear fell down. She kept her eyes glued on the preacher, but very quietly picked up the fallen garment and put it in her purse.

Fred entered the Decatur Baptist Church in the fall of 1942, and was married to Effie Hawkins of Decatur, in September of 1943. The following March, he enlisted in the Navy as a signalman 2nd class, and served until January, 1946. He was aboard a troop transport ship on the Pacific Ocean and saw many of the Marshall Islands.

He was at Okinawa and Iwo Jima, and saw some of the bloodiest fighting. On September 2, 1945, he was in Tokyo with the first ships that went in at the close of the war to liberate some of the POWs.

Following his term in the Navy, Fred went back to Decatur College for a year, transferred to Austin College at Shuman, and received his degree at East Texas University at Commerce. He worked on his Masters there. He also attended Southwestern Seminary at Ft. Worth.

Let Us Do Your Christmas Baking

For Your Convenience Order Early
We Have Homemade
(no mixes)

Fruit Cakes, Cakes, Candies
Cookies, Pies

Phone 754-5709
Or Come By

The Bakery

115 N. Main

Returning from the service, Fred pastored a church at Trenton in East Texas, and it was there that the most unusual experiences of his ministry occurred. He pastored this church twice. He had accepted a call to Newelton, LA., and had been gone a week, when the church at Trenton burned. The people asked him to come back and help them in a building program.

The night the church voted to recall him there were 140 Baptists present and two Methodists, they also asked for the privilege of voting and Fred Thomas received 142 votes for recall. He says this is the first time in history, to his knowledge, that the Baptists let the Methodists help them call a preacher.

While the men were digging the foundation they unearthed many worms, about a foot long and thick as your finger. They pitched these worms in a can and planned to use them for fish bait. A reporter came out from the city and put his story in a conspicuous place in the newspaper. The Associated Press and the United Press picked it up and because of the publicity the church heard from 38 states. They got some donations and also advice about what to do with the worms. A man from Kansas wrote an open letter to the newspaper. He suggested the pastor let the members have the worms to go fishing, with the first fish being given to the church and 10% thereafter.

One member of the church was a kleptomaniac. Bro. Thomas had been helpful during her husband's illness and death. During a revival she invited him and the evangelist to have dinner with her. For dessert she served "cornbread pie", her husband's favorite. It was a beautiful pie, mush topped with meringue, and out of courtesy Fred ate some and complimented it. The next day she brought a pie to the house. He and Effie didn't know what to do. They couldn't put it in the garbage, for it wasn't in covered cans at that time, and with her habits they were afraid she would find it. So, in the dead of night he buried that pie.

From East Texas the Thomases went to the Plains where he pastored churches at Whitharral, and Lovington, N.M., before going to Morton. He stayed there for 9 1/2 years and the church gave him a trip to the Holy Land in 1961. He traveled with a group, they were gone 34 days and covered 13 countries. With this and his naval travels, Bro. Thomas has been almost around the world. From all his experiences he is grateful to be an American.

From Morton the Thomases went to Aspermont, then Rotan and to Winters in 1977. They have a son, Freddy of Lubbock and a daughter, Mrs. Ronnie Floyd of Palacios, and one grandson, Joshua Thomas Floyd.

Brother Thomas has seen many changes through his years in the pastorate, but Christ has been sufficient and will always remain so. The hope of the world lies in the strength of the Church of Jesus Christ. It will have to be the church, God's only instrument.



Orchid and English ivy roots grow upward, into the air.



New York state leads the nation in percentage space devoted to state parks. Much of the thanks goes to a crusade by Theodore Roosevelt, who established the national park system.

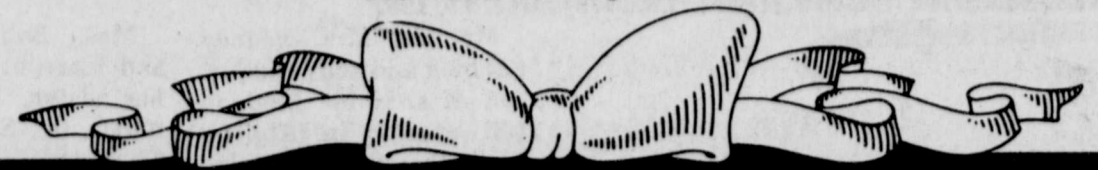

THE WISH STORE

YOUR JOHN DEERE DEALER MAKES CHRISTMAS WISHES COME TRUE

TOYS TOYS TOYS

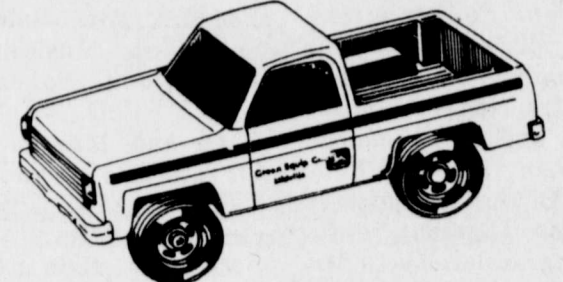
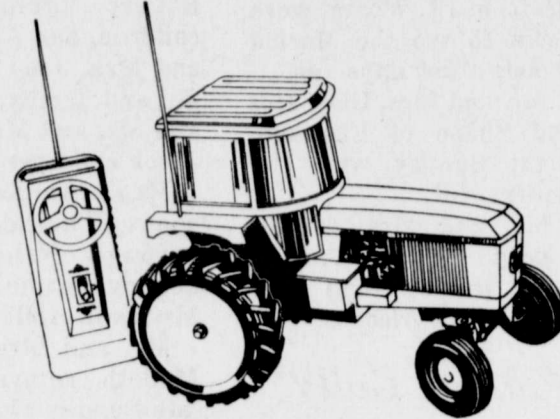
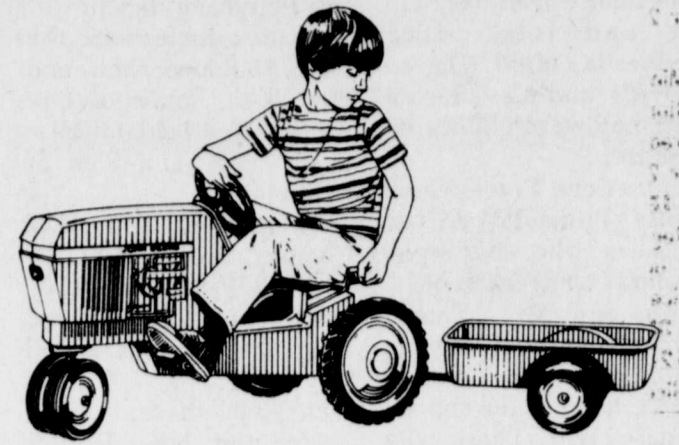
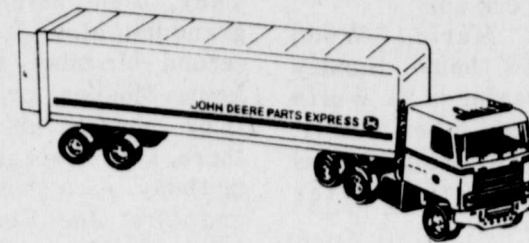

Stuck for gift ideas?

Stop in, we'll take care of you. Under one roof, you'll find toys, tool chests, lawn and garden equipment, high-pressure washers, power blowers, casual wear, barbecue grills, nylon-line trimmers... get the picture? We're here to solve all your Christmas gift problems.



MANSELL BROS.

Great Value

T. A. Smith Drug, Inc.
143 W. Dale

Whitman's
CHOCOLATES

St. Regis
TRAVEL ALARM



Aqua Velva
\$2.59



SHAVERS SET
Contains 6 oz. Aqua Velva
Ice Blue After Shave plus
Gillette Atra® Invitation
Razor.



TYLENOL
EXTRA STRENGTH
CAPSULES

\$4.44
100 CAPSULES

DECEMBER

Ladies and Mens

Pocket Accessories

- Ladies Checkwriters
- Ladies French Purse
- Men's Trifolds
- Men's Wallets

YOUR CHOICE!

\$7.77



John Deere's forward-looking "rear end" design is too tough to top... even after 20 years

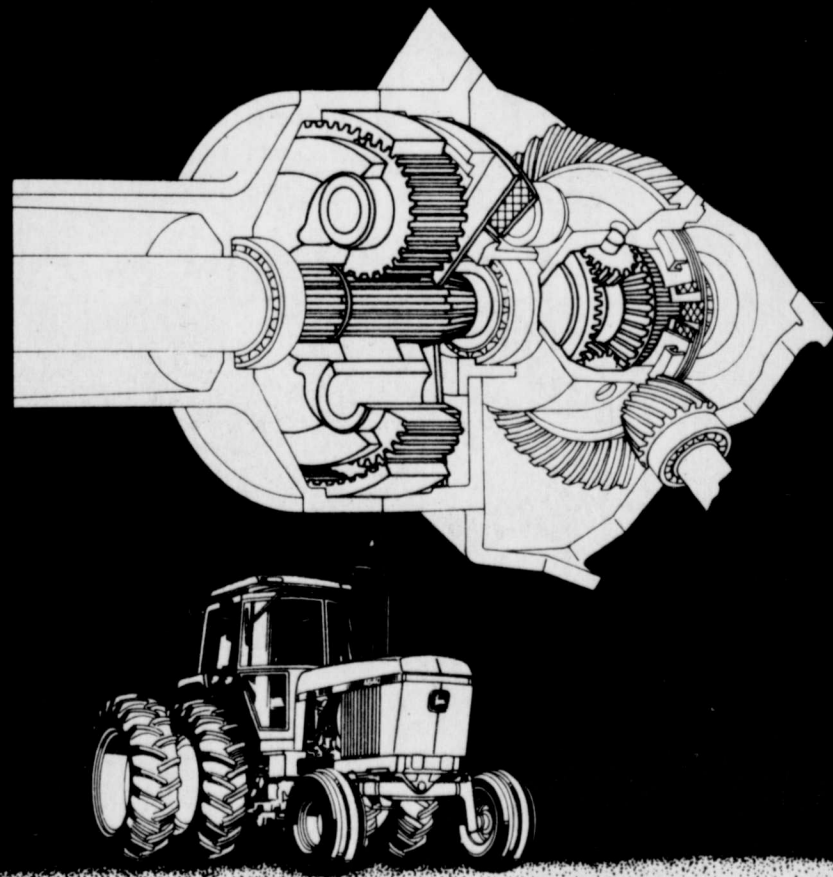

Many John Deere owners can't remember a time their field tractor didn't have planetary final drives. That's only natural, because John Deere hasn't built a big tractor without them for the past 20 years. Planetary final drives spread stress loads over three points instead of concentrating them in one. It's the best way we know to extend service life.

Wet disk brakes have also been a John Deere standby for the past 20 years. You get positive stopping force combined with extremely long life. The brakes operate in a sealed compartment and are

cooled by hydraulic oil. They also never require adjustment.

About four years ago, John Deere began using additional pinions in the differential. Again, to spread torque load. Our latest designs use needle roller bearings.

John Deere design is still too tough to top... even after 20 years.



Year after year, a John Deere seems newer

MANSELL BROS.

Hwy. 53 West Winters, Texas Phone 754-4582

Crews

Why are there so many last minute details, and so few last minutes?

Brother Aikens of Ballinger, missionary of this area, had the sermon at Hopewell Baptist Church Sunday. Mrs. Aikens accompanied him.

Hopewell Church will have their Christmas Supper and tree party Wednesday night. Glad to hear Mr. and Mrs. Burley Campbell were able to be in church.

Mrs. Cora Petrie came home Thursday after days in the Ballinger Hospital for treatment.

Mr. and Mrs. Therin Osborne honored Bernie Faubion on her birthday with a hamburger supper Friday night. Those who came were Dennis McBeth, Mr. and Mrs. Rodney Faubion and boys, Mr. and Mrs. Dale Duggan and children, Mr. and Mrs. Noble Faubion.

Mr. and Mrs. Coleman Foreman visited with his dad, O. Z. Foreman in Abilene, Thursday.

Congratulations to Mr. and Mrs. Boug Bryan on their sixth great-grandchild, born Thursday in North Runnels

Hospital, named Jason Douglas, son of Mr. and Mrs. Kenny Nitsch of Winters.

Visiting in the Doug Bryan home were Mr. and Mrs. Dewitt Bryan, Wilmet; Mr. and Mrs. Lelon Bryan and Vickie, Coleman; Mr. and Mrs. Rec Pritchard, Bryan.

Sunday dinner with the Sam Faubions; Mr. and Mrs. Ken Baker of San Angelo, and Mr. and Mrs. Fred Tryee and Sam of Ballinger.

Pat, Earl and Ray Cooper returned from Aransas Pass where they went deep sea fishing. Pat caught a 9-lb. shark and Ray caught a 7 foot, 4 inch, 70-lb. shark.

Mr. and Mrs. Horace Stokes of Talpa; Mrs. Lemma Fuller, Coleman; and Mrs. Alta Hale attended the Musicales in Brownwood Saturday night.

Mr. and Mrs. Norval Alexander's grandson, Blue of San Angelo, spent a week out here.

Mrs. Alta Hale attended a bridge party and luncheon Tues. in the home of Miss Edith Tombs, Coleman.

Mr. and Mrs. Rodney Faubion and sons and Mr. and Mrs. Noble Faubion had supper in Abilene with the Danny Philips family, Friday night. They also went to the Abilene Boys Ranch to see Kenny Smith and give him a Christmas present of money, that the Hopewell Baptist Church is sponsoring for Kenny.

The Noble Faubions visited with the Mike Praters and son Jeremy in San Angelo after Mrs. Faubion saw her doctor for a check-up.

Mrs. Marion Wood returned home Sunday after staying in Ft. Worth 10 days with her mother, Mrs. Katie Bodine who is recuperating after surgery.

Ronnie Walters and Brett, of Ft. Worth, were down to see the Marion Woods a few days ago.

Mr. and Mrs. Gary Hill and Shane of Eastland, spent Sunday with the Robert Hills.

Mr. and Mrs. Donald Alcorn of San Angelo spent the weekend with the Wilbert Alcorns.

Carolyn Gully receives car in recognition

Carolyn Gully, a Sales Director in the independent field marketing organization of Mary Kay Cosmetics, Inc., has been awarded the use of a new, pink Buick Regal in recognition of her outstanding sales achievement with the Dallas-based company.

Under her direction, over the past six month period, Ms. Gully's sales unit has become one of the top in the Mary Kay organization, which continues to reflect the growing prominence of women in business and appropriately recognizes their capabilities.

Since its inception in 1963, Mary Kay has grown from a regional cosmetics firm into an international organization comprised of more than 120,000 independent Beauty Consultants and over 3,000 independent Sales Directors who demonstrate and sell Mary Kay's products.

The company's net sales were \$91.4 million in 1979 and \$166.9 million in 1980. Net sales for the first three quarters of 1981 showed a 48% increase over the same period in 1980 — \$174.3 million for the prior year.

Mrs. Bob Alexander and I ate breakfast with her sister, Mrs. Minnie Nutt in San Angelo Thursday.

Clara McKissack and Stella McClure of Talpa came out to see Mrs. Effie Dietz. The Clarence Hambrichts of Winters came Sunday.

Mr. and Mrs. Walter Jacobs spent the weekend in Snyder with the Mike Kozelsky family. On Sunday they attended their granddaughter Kathrin's piano recital. They also celebrated granddaughter Jeanna's second birthday. Father Louis Moeller, priest of their church also was there, and celebrated his birthday. Also there; Mr. and Mrs. Joe Kozelsky, Winters; Mr. and Mrs. Robert VanZandt and children, San Angelo; Mr. and Mrs. Joey Kozelsky, Jr. and family, Winters; and Mr. and Mrs. Walter Jacob and Brenda Jacob.

Mrs. Amber Fuller spent Thursday night through Friday with Johnny, Joanie and Mark Mathis in Abilene.

Mr. and Mrs. Chester McBeth returned home late Sunday after several weeks in M. D. Anderson Hospital where Wilma was taking treatments. Welcome Home, you two!

The Connie Gibbs' family spent Sunday with daughter Mr. and Mrs. Travis Ford and family, in Rising Star.

The John Sims family attended the Young Women's Circle Christmas Party at the Lutheran Church Sunday night.

Gifts exchanged at Diversity Club meeting

The Diversity Club members enjoyed a Christmas party at their regular meeting in the home of Mr. and Mrs. Frank Brown December 10. Mrs. Charles Hudson shared hostess duties with Mrs. Brown.

Club President, Kat Young, presided for the business meeting. Freda Hudson called the roll and read the minutes of the last meeting. Ferrell Dean Brown gave the treasury report, and a public affairs report was given by Dorece Colburn.

Grace Roach told a Christmas story in verse, "Annie and Willie's Prayer".

Gifts were exchanged from a beautiful tree, and Christmas cookies and punch were served to members Mmes. Lee Colburn, Frank Brown, Z. I. Hale, Charles Hudson, J. L. Johnson, C. R. Kendrick, Weldon Middleton, Earl Roach, J. E. Smith, Fred Young and Roy Young.

Christmas festivities enjoyed by members of Dorcas SS Class

The Dorcas Sunday School Class met December 8 at the noon hour in the fellowship hall of the church for their regular meeting and social hour.

The class prepared fruit plates for several shut-in members of the church.

A Christmas devotional was given by Alice Traylor.

Members who enjoyed the luncheon and gift exchange were Merle Bains, Oletha Elder, Ann Grenwelge, Ethel Graham, Velma Hart, Alma Hughes, Vela Laird, Verda Smith, Nadeen Smith, Carrie Compton, Alice Traylor, Grace Waggoner, Stella White, and Lillian Roberson, with the benediction being given by Mrs. Roberson.



Rumanians claim descent from Roman soldiers and colonists who occupied the land beginning in 79 A.D.

Winters area farmers attend Young Farmer Educational Institute

Dale Duggan, Mr. and Mrs. Michael Deike, and Mr. and Mrs. Scotty Belew have recently returned from Hershey, Pennsylvania where they attended the 15th National Young Farmer Educational Institute. The theme of the Institute this year was "Yesterday's Dreams, Today's Realities, Tomorrow's Future."

During the five day convention, they attended several banquets and a number of tours. Some of the highlights of their trip included a tour of Chocolate World and the Milton S. Hershey School and Foundation Hall. They toured the Gettysburg National Military Park and Battlefield which consists of 3,400 acres. It is the largest Battlefield Shrine in America, having more than 1000 monuments and cannons. They also toured

Be Busy Sewing Club exchange gifts

The Be Busy Club met in the home of Mr. and Mrs. Lewis Blackmon recently, with gifts being exchanged.

Present were Mrs. James Torrence, Mrs. Bill Milliern, Faye Hogan, Eta Bryant, Eura Loyd, Nadeen Smith, Lillie Shott, and the hostesses, Mr. and Mrs. Lewis Blackmon.

The next meeting will be in the home of Faye Hogan on Monday, January 11, 1982.

Wingate Sew and Sew met for Christmas party

The Wingate Sew and Sew Club met for their Christmas party on December 8 at the Lions Club building.

Gifts were exchanged. Attending were Rubye Folsom, Ethel Polk, Mildred Patton, Nellie Adecock, Madlin King, Lorene Kinard, Eva Loyd, Lessie Robinson, Vida Talley, Marie Bradford, Mayola Cathey, and one visitor, Virginia Henslee.

The next meeting will be held January 5 at the Lions Club building with Ethel Polk as hostess.

as well as a mushroom the nation's leading speakers.

Later the men attended a number of workshops while the ladies enjoyed a special ladies program given by Judith Keith, noted author and one of the 1982 Institute will be held in San Antonio, hosted by the State Association of Young Farmers of Texas.

Simon's Seafood Market
will be at
Piggly Wiggly Supermarket
Friday, December 18
3:00 p.m. to 6:30 p.m.

Visa, Master Card & Food Stamps
gladly accepted, Checks with Drivers Licenses

NOEL

A wealth of warm wishes from us to all our wonderful customers we delight in serving throughout the year. We invest our best efforts in fulfilling your banking needs. Christmas greetings to all!

We invite you to have refreshments with us
December 22-23-24
9:00 a.m. to 3:00 p.m.

Winters State Bank

Order Your Christmas Flowers Early

— Flowers wired anywhere —
Don't wait for the rush!

Poinsettias

\$3.00 and up

Christmas Budvases & Corsages

\$1.75 and up

Christmas Arrangements

\$7.50 and up

Carnations

each 75¢

Come in and register for our GIANT Christmas Stocking to be given away Dec. 23. Children under 12 must be accompanied by their parents.

Open: 8-11 a.m. & 12-5 p.m.

Blossom Shop

117 N. Main 754-5311

Remember

Bosses, Husbands, Boyfriends

With Love from
Merle Norman

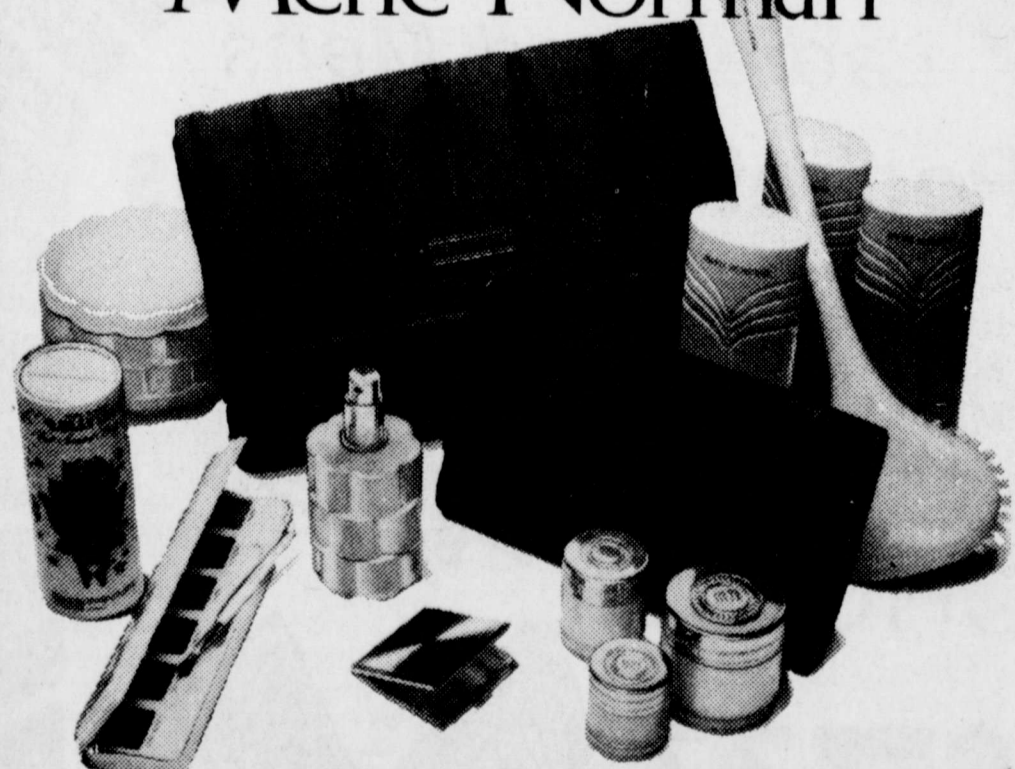

For You and Christmas Giving.

It's a Christmas tradition for Merle Norman to dedicate gifts to every woman's love of beauty and designed to please the most discriminating taste. You're invited to come to your Merle Norman Studio... and browse among some truly exciting new gift ideas. Come with your gift list early... we don't expect these fabulous gifts to last long.

MERLE NORMAN
The Place for the Custom Face®

137 N. Main 754-4322
Winters, Tx.

Free Gift Wrapping and Gift Certificates

Phone someone this Christmas.



This year, say Merry Christmas with a phone from GTE. We've got phones that say it the old-fashioned way, phones that take the modern approach, and phones that stand on their own two feet (and come with their own two ears). What's more, you can actually take these phones home, wrap them up and put them under the tree. So call your local General Telephone business office. For a gift that really communicates.

General Telephone

GTE

Most styles available in most areas.

© WALT DISNEY PRODUCTIONS



Jerry Lackey's Country Folk

I zipped around the block from my office the other day and selected a pretty little Christmas tree for the lobby of Lackey Communications. Secretary Phyllis Harrison, decorated the Scotch pine and the spirit of the holiday season began to take effect on the office staff.

My tree search took all of five minutes, certainly much different from the old days when we climbed all over hills and valleys for the right shaped cedar tree. As a boy, I usually spotted the ideal tree from horseback riding on some draw, several months before. But when it came time to ax the tree, I forgot where the tree was growing.

One year, when I remembered the perfect tree, I got there to cut it down and it was all brown and appeared to be dying. It has taken 30 years to find a reason for that.

Roger O. (Jake) Landers, Jr. a range specialist for Texas A & M University System, and a native of Menard, was visiting in my office and we were talking about trees.

"This time of year, or a bit earlier, some of the cedar trees turn rusty brown, sometimes it looks like they are dying," explained Jake. "This is the male tree with millions of tiny cones which are releasing billions of microspores (pollen) which are pollinating female trees for next year's berries."

"Hit a male cedar branch and it will pollinate all over you," continued Landers. "Some people are very allergic to breathing cedar pollen. The cones fall off by Christmas and the plants are bright green again."

We have two species of cedar, Juniperus pinchtree and Juniperus ashei. The first is usually called redberry juniper. The berries are rusty brown and so abundant this year that some female trees look brown from a distance. Jake says he has also heard it called white cedar because of the light color of its wood. It is not as good for fence posts or stays, as heartwood cedar...Bob Nickel at Twin Mountain Supply in San Angelo can give you details on that fact.

Redberry will sprout when cut off at ground level, but blueberry won't. Redberry is more sensitive to picloran than blueberry. Seedlings of both species are easily controlled by prescribed burning.

Well, we sort of got away from finding the right tree, but I learned a lot from my chat with Jake. May you find the perfect tree to make your home a perfect Christmas this year!

Essay and poster contest open to Runnels Co. students

The Runnels Soil and Water Conservation District is sponsoring Conservation essay and Conservation poster contests again this year. The essay contest is open to all students in grades seven through twelve in Runnels County. The poster contest is open to all students in grades Kindergarten through six in the county.

Material for these contests will be distributed to the schools in the District by the Board of Directors with assistance from the Soil Conservation Service office located in Ballinger.

In addition to ribbons, the District is also offering cash awards for the three top winners in each contest this year. The first place winners in the contests will be eligible for the Area and State Regional Essay and Poster Contests.

The Runnels Soil and Water Conservation

Laura L. Turk died Tuesday in nursing home

Mrs. Laura Lena Turk, 76, died at 8:45 p.m. Tuesday night at the Senior Citizens Nursing Home.

Services were held at 3 p.m. Thursday, Dec. 10, at St. John's Lutheran Church with Rev. Lawrence Keene, officiating. Burial was at the Lutheran Cemetery under the direction of Winters Funeral Home.

Born Laura Gerhart on March 31, 1905 in Winters, she married Otto R. Turk December 22, 1925 in Winters. She lived in Wingate from 1939 to 1975 when she moved to Winters. Prior to 1939 she lived in the Dale Community.

She was a Lutheran. Her husband preceded her in death on November 11, 1972.

Survivors include two sons, Carroll Turk of San Angelo, and Herbert Turk of Winters; one daughter, Mrs. Douglas Wells of San Angelo; two sisters, Mrs. F. O. Minzenmayer of Winters and Mrs. Lorena Gerhart of Abilene; three brothers, Walter and Robert Gerhart of Winters, and Herbert Gerhart of Wilcox, Ariz.; and four grandchildren.

Former Wingate resident dies in accident

A. R. Wetsel, 73, a retired Abilene barber, was killed Wednesday night in a three-vehicle accident in Early.

The accident occurred about 9:40 p.m. at the intersection of Early boulevard and U.S. 67-183, with Wetsel suffering massive head and chest injuries when his westbound car collided head-on with another vehicle.

Wetsel's car apparently jumped a traffic median and veered into the east-bound lane.

Services for Wetsel were at 3:30 p.m. Friday at North's Funeral Home in Abilene with Larry Wishard, Church of Christ minister, officiating. Burial was in Elmwood Memorial Park in Abilene.

Born Jan. 8, 1908, he was reared at Wingate and moved to Abilene in 1941. He served in the U.S. Army Air Corps in World War II.

He had operated barber shops in Westgate Mall and in the River Oaks neighborhood after the war. He also barbered in Midland and Brownwood before retiring last year.

A member of the Veterans of Foreign Wars, he belonged to several barbers' organizations. He was a member of the Church of Christ.

Survivors include two sons, Roy and Andy of Abilene; a daughter, Rita Banks of Colorado City; five brothers, Albert of Wingate, Junior of Midland, Jesse of Dallas, Troy of Fort Worth and Coy of Midland; two sisters, Ruth Stovall of Abilene and Mittie Danford of Midland; and seven grandchildren.

Safety precautions for Christmas decorations

Stockings should be hung by the chimney with care — and so should a lot of other things at Christmas to avoid a holiday tragedy.

"In homes with fireplaces, don't hang decorations of tinsel, Christmas cards or tree branches from the mantel where they could become ignited," warns Harold Ray, Director of the Product Safety Division of the Texas Department of Health.

"And once those presents under the tree are opened, gather up all the wrappings and remove them from the home. Many colored gift wrapping papers contain lead and sometimes chromium, copper and zinc. These materials can cause toxic fumes if burned in the fireplace and can be harmful to children if they chew on them."

Ray has other holiday safety tips. In selecting a natural tree, he says, the needles should be hard to pull from the branches, and they shouldn't break when bent.

"Bounce the tree hard against the ground and you won't get a shower of needles if the tree is fresh," he said.

Christmas trees should be placed in a base which holds water and this should be checked regularly. Before mounting the tree, cut about two inches off the trunk to allow it to better absorb the water.

In selecting lights, check for the Underwriters' Laboratories "UL" label. On strings of lights, make certain all the connections are tight and that there are no frayed or bare wires that could short circuit and cause a fire.

St. John's to present cantata

St. John's Lutheran Church choir will present a Christmas cantata, "The Birth of Our Savior", Sunday, Dec. 20 at 10:40 a.m.

The cantata is under the direction of Erwin Henniger, with Ernestine Geistmann as the organist.

The public is cordially invited to attend.

See Us For Your Liability Insurance
—Monthly, 6-Months, or Yearly Payments—
GERHART INSURANCE
115 W. Dale 754-4578

COON COON COON

We Are Coon Specialists
We Want Your Coon
We Will Pay Good Prices
For The Top Quality Coon
We Pay CASH!

—Open 6 days a week—
9 a.m. to 5 p.m.

Coleman Fur House
1108 N. Neches
Coleman, Texas
O. L. Purcell, Buyer

COON COON COON

1981
HESSTON BUCKLE
NATIONAL FINALS RODEO
HESSTON

No. 7 in the Hesston collector's series
Hesston's "ProRodeo Bull-fighter" buckle commemorates the telecast of the 1981 NATIONAL FINALS RODEO in December. Don't miss this great prime-time telecast...and don't miss out on this great new limited-edition buckle!

Winters Farm Equipment, Inc.
Winters, Texas

*U.S. funds only. does not include Canadian tax, duty or exchange rate.

HESSTON The PRIME LINE

JIM'S STOP & GO
243 S. Main
Everyday Low Prices!

MARIGOLD MILK
Low Fat Homogenized
\$1.79 gal. \$1.89 gal.
50¢ Deposit

1 1/2 lb. loaf GOLDEN KRUST BREAD 59¢
10-lbs. No. 1 COLORADO RUSSET POTATOES \$1.59 per 10 lbs.

12-oz. RC COLA Or RC Flavors \$1.19 Six Pak (Hot)

Locally Owned & Operated

Winters Public School LUNCHROOM MENU

Monday, Dec. 21
Western spaghetti, green beans, tossed green salad with french dressing, peach pie, french sticks with garlic butter on top, milk or chocolate milk.

Tuesday, Dec. 22
Turkey and dressing with all the trimmings, cranberry sauce in cups, early June peas, fruit salad with whipped cream, hot rolls with butter on top, milk or chocolate milk.

Merry Christmas & Happy New Year to each and everyone
Mr. & Mrs. Ernest Haupt

Christmas With Love is Caring



Add sparkle to your iced cakes by garnishing them with crumbled rock candy.

Santas Selections

DRAMATICALLY BEAUTIFUL WITH A SWEEPING PROFILE

- UNIQUE ULTRAMODERN STYLING
- ADVANCED SPACE PHONE
- 4 SPEAKER SOUND
- 25" DIAGONAL SCREEN

The PANORAMA 200 • SN2541X
Computer SC4000 Remote Control with ADVANCED SPACE PHONE

Sleek architectural lines distinguish this full-to-the-floor console. The curvilinear front with its smooth, silver color surface contrasts dramatically with the simulated grained Rosewood top and ends. Casters. Quartz-Controlled Electronic Tuning, PRP (Peak Resolution Picture) Circuit, Time Control Programmer, Up/Down Channel Scanning, On-Screen Channel Number and Time Display, 112 VHF/UHF/CATV channel capability without converter (except scrambled programs). Audio Output Jack. Cabinet size: 31 1/2" H (incl. casters), 44 3/4" W, 21 1/2" D (incl. cabinet back). (79.4 cm H, 112.7 cm W, 54.0 cm D.) Dimensions exclude controls.

Also with Computer SC3000 Remote Control: The PANORAMA 100 • SN2539X

Decorators Series

For today's home and apartment lifestyles
17" ZENITH SYSTEM 3 TABLE TV

- TRI-FOCUS PICTURE TUBE
- COLOR SENTRY AUTOMATIC COLOR CONTROL
- TRIPLE-PLUS CHASSIS

The ROWLANDSON • SN1743W
Computer SPACE COMMAND 1800 Remote Control

Smart, decorator styling. Simulated grained Walnut finish with horizontal brushed Nickel color trim. All tuning controls concealed behind a door finishing matching Walnut color. Quartz-Controlled Electronic Tuning, Time Control Programmer, Up/Down Channel Scanning, On-Screen Channel Number and Time Display, 112 VHF/UHF/CATV channel capability without converter (except scrambled programs). Audio Output/Earphone Jack. Earphone, CATV/MATV Antenna Connection Provision. Cabinet size: 16 1/2" H, 24 1/2" W, 15 1/2" D. (41.0 cm H, 61.3 cm W, 39.7 cm D.) Dimensions exclude controls and antenna protrusions.

The HILLIARD • N1740W
Contemporary styling. Simulated grained American Walnut finish with horizontal brushed Aluminum color trim. Control area is horizontal brushed Aluminum color. Precision Electronic Tuning, One-Knob 12 VHF and 6 UHF Channel Selector, VHF/UHF Deluxe Spotlite Picture, Electronic Power Sentry Voltage Regulator, Automatic Fine-tuning Control, Picture and Sharpness Controls. Cabinet size: 16 1/2" H, 24 1/2" W, 15 1/2" D. (41.0 cm H, 61.3 cm W, 39.7 cm D.) Dimensions exclude controls and antenna protrusions.

Simulated TV Pictures

WESTERN AUTO



VFW presents check

VFW Post 9193 Service Officer Ted Meyer hands a \$100 check to Scoutmaster Manuel Vera. Vera said the money will be used in a program to improve the Boy Scout Hut. The VFW Post also gave \$50 to the Salvation Ar-

my, \$100 to the Christmas program for underprivileged children, and designated \$500 to be used to purchase walkers, wheel chairs and other bedside equipment for use in the Winters area.



Opens Monday...

Winters Oilfield Supply, Inc., the newest business in Winters, will open for business Monday. Manager Jim Black and employee Jack Pierce check over some of the merchandise just ar-

rived in the show room. The business will feature a complete pump show featuring Harbison-Fischer pumps and components and will open the pump show shortly after the first of the year.

NORTH RUNNELS HOSPITAL REPORT

ADMISSIONS

- Dec. 8
Simon Mata
Bill Hamilton
Anita O'Dell
- Dec. 9
Rita G. Quiroz
Judy Palmer
- Dec. 10
Floyd Ray Wood Jr.
Marie Wheat
- Dec. 11
No Admissions
- Dec. 12
D. E. Pinegar
Sarah Hearn
Jeannette Small
- Dec. 13
Cora Matthews
Baby Girl Small
- Dec. 14
Marie Ochoa

DISMISSALS

- Dec. 8
Eva Reese
Frances Watson
Bradley Stephenson
- Dec. 9
Domingo Ortiz
Pat Baker
Johnny Grant
Mary Shields
- Dec. 10
Brett Burleson
Anita O'Dell
Thomas W. Norman
Leona Hicks
Simon Mata
Judy Palmer
- Dec. 11
Bill Hamilton
Marie Wheat
- Dec. 12
Rita G. Quiroz
Floyd Ray Wood Jr.
- Dec. 13
Sarah Hearn
- Dec. 14
Jeannette Small, trans.

THE AVERAGE STICK OF GUM 8 CALORIES

The average stick of gum contains eight calories.

The drum is the most widespread, sacred and ritually significant of all musical instrument.

MEN'S SLEEPING WEAR ROBES ONE SIZE FITS ALL \$14⁹⁵
Pajamas SIZE A-B-C-D-E \$9⁹⁵
 ALSO FOR TALL MAN

MEN'S WRANGLER JEANS \$16⁹⁵

MEN'S INSULATED COVERALLS
 Available in longs, shorts and med. Made from strong sateen fabrics, perm. press, zip front and pockets, knit storm cuffs
 \$39⁹⁵

WOMEN'S BRUSH ROBE NYLON GOWNS
 ALSO EXTRA SIZES INCLUDED
 COMPARE AT \$10⁰⁰ UP

MEN'S THERMAL UNDERWEAR
 50% poly, 50% cotton, heavy weight for extra warmth. Shirts or Pants
 \$3⁹⁹ EACH

MEN'S JACKET
 NYLONS, CORDUOYS, POPLINS
 Quilted Lined or Shearling Lined
 \$29⁹⁵ UP

MEN'S TONY LAMA BOOTS
 MOST STYLES
 \$99⁹⁵ to \$125⁰⁰

MEN'S HANDKERCHIEFS
 5 In A Box
 \$1⁹⁸

MEN'S FLANNEL SHIRTS
 TREMENDOUS SELECTION
 SMALL, MEDIUM, LARGE AND EXTRA LARGE
 ONE SPECIAL GROUP
 \$7⁹⁵

FREE GIFT WRAPPING

Meteors are small bits of iron, nickel or stone traveling through space at high speeds.

GE 10" diagonal PORTA COLOR TV with Automatic Frequency Control
 • Automatic Color Control • Automatic Frequency Control • In-Line Picture Tube • 100% Solid State Chassis
 Reg.: \$359⁹⁵
 Sale Price
\$299⁹⁵

GE 19" diagonal COLOR TV with VIR II BROADCAST CONTROLLED COLOR
 • VIR II Broadcast Controlled Color • Automatic Frequency Control • In-Line Black Matrix Picture Tube • 100% Solid State Chassis
 Reg.: \$499⁹⁵
 Sale Price
\$399⁹⁵

MICROWAVE OVENS REFRIGERATORS GAS RANGES LIVING ROOM SUITES BEDROOM SUITES

PRE CHRISTMAS SALE

12" diagonal BLACK & WHITE TV
 Reg.: \$129⁹⁵
SALE: \$99⁹⁵

PRE CHRISTMAS SALE

GUN CABINETS DECORATOR TABLES DESKS DINETTES CURIO CABINETS

Two cycles—regular and permanent press.
Standard capacity, single speed washer.
Three water level selections let you match the water level to most size loads.

**Reg.: \$449⁹⁵
 Sale: \$399⁰⁰**

Standard capacity, timed dryer.
Four cycles—regular, damp dry, permanent press and dewrinkle.
Three drying selections—normal, low, no-heat.

**Reg.: \$349⁹⁵
 Sale: \$309⁰⁰**

W/Trade

ACME COWBOY BOOTS FOR MEN
 NEW STYLES TO CHOOSE FROM
\$59⁹⁵

Jarman SHOES FOR MEN

SEE OUR WIDE SELECTION OF DRESS AND CASUAL SHOES BY JARMIN

\$29⁹⁵ UP

Choose Your Holiday BAG NOW

All the new styles
 Plenty of Shoulder Straps and Clutches
 Your Choice of Colors

\$5⁹⁹ TO \$10⁹⁹

HEIDENHEIMER'S

FREE DELIVERY SERVICE AFTER THE SALE

McDorman's
 THE STORE FOR PEOPLE WITH MORE TASTE THAN MONEY!

OPEN MON.-SAT. 8:30-5:30 p.m. 200 S. Main