

Mainly About People

HAVE YOU been visiting had visitors bought anything sold anything had a party been to one got engaged, joined a club or been thrown out of one, had triplets quadruplets or even one baby?

THAT'S NEWS and we, and your friends would like to know about it

TELL THE EDITORIAL DEPT. a staff member will write it up, and we'll all know it!

AND TO BE SURE YOUR name is spelled right, be sure to give it to us right, and so that we can read it

JUST WRITE IT DOWN on a piece of scrap paper or something and bring it in or mail it to us and we'll all be happy!

THANKS!

Permanents reduced till Feb 10th \$7.50 for \$12.50 \$10.00 for \$15.00 for \$10.00 Yates Beauty Shop, Phone 848.

The Gallies haven't found that house yet, but they've been too busy taking care of a sick boy to worry about an ad. If anyone knows where they can find a large un-

furnish house for rent or lease in the appropriate location at 2351W and will show their appreciation with a reward.

Mrs. Charlie Black of White Deer Repair Sales & Service Ph 1565.

For immediate sale Hollywood double bed, mitering mattress like new. Phone 1978W.

For Sale Extra Sturdy Twin beds. Phone 1943J.

Mr. and Mrs. Perry Franklin and daughter, 513 N. Magnolia, are spending the weekend in El Reno Okla. with Mr. Franklin's sister, Mrs. Pat Vance, and family. Mr. Franklin was in Oklahoma City on business Friday.

Attend a good school that can place you in a good job when you finish. Pampa Business College.

Free Instant Ambulance #2454. Mrs. John L. Witt and Mrs. Charles Fields of Groom were in Pampa Friday.

Do you need a typist for club or extra news reports. Contact Mrs. Janet Graham at 1304W or 506 Fifth Ave.

Fuller Brushes 514 Cook #2153J. Mr. and Mrs. W. C. Epperson are the parents of a son, Vernon Scott, born Jan. 30 at Worley Hospital. He weighed five pounds, seven ounces. He is welcomed by a brother, Gray Lynn, age three. The Eppersons live four miles east of Pampa.

Like hot bread? It's ready for you nights and early morning at Pam-

Baking Co. 848 W. Foster. Mr. and Mrs. Fred Haley Tinsley, 1004 E. Fisher, announce the birth of a 6 lb. 2 oz. son at Worley Hospital on Jan. 27. The baby has been named Fred Haley, Jr.

Hot Point Refrigerator on our floor ready for delivery. See at Modern Appliance Co. 110 E. Foster.

Mr. and Mrs. Eugene Shepard and their two little daughters, Julie and Jean from Austin are visiting in the home of his grandmother, Mrs. G. H. Reber, 217 N. Gillespie. Shepard has just received his degree in engineering from the University of Texas and he will be leaving soon for Pittsburgh, Pa. where he will be employed by the Gulf Oil Company. Mrs. Shepard and the little girls will be house guests of Mrs. Reber for a few weeks.

Kent Nickelodeons, Call 273 Top O. Texas Amusement Co. Button holes, 818 Frost #228W.

F. C. Buell is visiting in Denton this weekend.

Protect your bicycle. Have serial number registered free of charge any Saturday morning at Roy and Bob's Bicycle Shop, 414 W. Brown, Phone 748.

Mr. and Mrs. W. R. Combs of Le- tons were in Pampa Friday on business. While here they visited with Mrs. Fred Wedge.

Get scientific cleaning. Make sure you are getting the best by having all of your cleaning done at Pampa Dry Cleaners. Phone 88.

Miss Evelyn Milam and Miss Nancy Sullivan left Friday to spend the weekend in Fort Worth, Denton and Dallas.

You can send your finest garments to us for cleaning and pressing. Make sure of complete satisfaction. Master Cleaners.

Little Patricia Ann Bond of Borger is a guest in the home of her grandparents, Mr. and Mrs. O.

H. Gilstrap, 329 Nalida. We are not going out of business. Come in and see our new spring and summer samples. Hawthorne Tailoring Shop, 206 N. Cuyler. Phone 920.

Miss Ann Holmgren is visiting in Worth and Dallas this weekend.

Mr. and Mrs. Wade Duncan left yesterday for Columbia, Mo., where their daughter, Angela, will enter Stephens College.

Final Rehearsal For Revue Today

All members of the cast, light operators and other stage hands have been asked by Ken Bennett to be on hand this afternoon at 2 o'clock for the final rehearsal of the Top of Texas Revue which will be enacted at the Junior High School Auditorium Monday and Tuesday nights.

The annual event, sponsored this year by the Pampa Kiwanis Club, will feature a group of personalities, it has been announced. Tickets for the show are on sale by all members of the Kiwanis Club, and reserve seat tickets are on sale at the Gretna Drug Store and tomorrow will be on sale in the lobby of the Combs-Worley Bldg.

He Swears Off the Stuff for Life

FORT SILL, Okla., (AP)—T. J. Donald S. Williams, who mixed his alcohol with a 2-ton self-propelled howitzer and nearly panicked the city of Lawton, was pledged to a life of teetotaling today.

He is faced with a special court martial on two charges—being drunk and misusing government property, to wit, the tank-like howitzer.

"I will never touch another drop of whisky as long as I have control of my senses," the 24-year-old soldier from Decatur, Texas, told Army investigators Friday.

In a Hollywood interlude last Friday, Sgt. Williams led MP's a merry chase to, through, and from nearby Lawton in the huge machine hitting three parked cars and sending citizens scurrying.

His commanding officer in the Second Rocket Battery at the Fort praised William's previous record. "He has been an exemplary soldier," Capt. Maynard L. Trott said.

It was the soldier's first howitzer ride. He said he was "blacked out" during the incident.

Peanuts are an important money crop in nine states of the United States.

Under common law there is no such offense as espionage during a time of peace.

Don't worry—everybody else has been doing it, too. Just change 1947 on your letters to 1948.

NOTICE TO THE PUBLIC

The full interest of **EDMONDSON DRY CLEANERS** has been acquired by **Talmage J. Wright and Phillip W. Harvey, both of Pampa. The new firm, effective February 1st, 1948, will be—**

Fashion Cleaners

The new firm will retain the present staff—

Phillip W. Harvey, Manager
James C. Webb, Plant Manager

Fashion Cleaners will continue to offer modern up-to-date dry cleaning service, fur storage and renovating, alterations and leather coat cleaning and repairing. Pick-up and delivery service.

115 South Ballard Phone 844-845

SPECIALS FOR

DOLLAR DAY

SUITS

FINAL CLEARANCE OF FALL SUITS

Values To \$45.00

\$10.00



DRESSES

Spring Gabardine Dresses IN Pastel Shades

Values to \$27.95

One group of Fall Dresses in Crepes; in Darker Shades, val. to \$34.95

\$10.00



DRESSES

ONE SMALL LOT OF BETTER DRESSES* FOR ONLY

\$5.00

ONE TABLE OF

Blouses

Bras

Sweaters

House Shoes

Gloves

Slips

Your Choice..... **\$1.00**

House Coats & Robes

Quilted Brunch Coats

Quilted Robes

Cotton House Coats

Wool Robes

Values to \$29.95

\$5.00

GILBERT'S

PROGRESSING WITH PAMPA

WIN CASH ... ENTER PEPSI-COLA "TREASURE TOP" SWEEPSTAKES and CONTESTS



Look under the cork—every PEPSI-COLA BOTTLE TOP has a hidden design



Enter the great PEPSI-COLA

\$203,725.00*

"TREASURE TOP" SWEEPSTAKES and CONTESTS

51 separate prizes in each state each month—plus monthly national prizes—plus \$25,000.00 1ST PRIZE in Family Sweepstakes

*TOTAL CASH (including dealer prizes)



Collect and swap PEPSI-COLA "TREASURE TOPS"... it's fun



HERE ARE THE OFFICIAL CONTEST RULES:

- On your entry blank or a sheet of paper, complete the statement in 25 words or less: "Pepsi-Cola has the spot because..." Then write down your own name and address, the name of the head of your family, the name and address of the Pepsi-Cola dealer who helped you, and the total number of different designs on Pepsi-Cola "Treasure Tops" you have collected. Then mail your entry, together with one Pepsi-Cola "Treasure Top" with cork removed to show hidden design, to: Pepsi-Cola "Treasure Top" Contests, P. O. Box 18, New York 8, N. Y.
- Entries with insufficient postage will not be accepted.
- The number of different designs you have collected will not be a factor in the awarding of the prizes. However, when you win a monthly prize, you must be able to show your total collection of different designs reported in the winning entry. Also, it's fun to collect and swap "Treasure Tops." Do not send your collection of "Treasure Tops" with your entry. Send in only one top with each entry.
- You may enter these contests as many times each month as you wish, but no entry postmarked after June 30, 1948 will be accepted. Each time you enter, whether you win a cash prize or not, we will mail you a Treasure Certificate good for 100 points toward the \$37,000 Family Sweepstakes Prizes. If you win any one of the monthly prizes, you will receive 100 additional Treasure Certificate points.
- All entries received during each calendar month will be judged in that month's contest. Entries from each state (and from the District of Columbia) will be judged separately, and will compete for the monthly prize only with other entries from that state.
- Monthly cash prizes as listed on this page will be awarded on the basis of aptness, originality and interest of the statements submitted (see Rule 1). Each month's national prizes will be awarded to the three best entries of the 49 state first prize winners in each monthly contest. All entries will be judged by the impartial judging staff of the Reuben H. Donnelly Corporation, an independent, nationally-known contest judging organization. Decisions of the judges will be final. Names of winners will be published.
- All entries must be prepared by the contestant. Elaborate or fancy entries will not count extra. All entries and statements become the property of the Pepsi-Cola Company and none will be returned. In case of ties, the prize tied for will be awarded to each contestant, except for the sweepstakes prizes, procedure for which is listed under Rule 8.
- Only contestants living within the 48 states or the District of Columbia will be eligible. Anyone may enter these contests except the employees of the Pepsi-Cola Company, Pepsi-Cola bottling companies or their advertising agencies. Members of the families of these employees are also excluded.

8. HUGE NATIONAL SWEEPSTAKES PRIZES WILL BE AWARDED AS FOLLOWS:

(a) Each Treasure Certificate received by you or members of your family (see Rule 3) counts 100 Sweepstakes Points for your family. Save them! (For the purpose of this contest, a "family" shall be considered as only persons related by blood, marriage or adoption living in the same household under one family head.)

(b) The 100 families, plus families tying with any of them, who have received the greatest number of Sweepstakes Points in the competition, qualify for the Sweepstakes Finals. Each family thus qualifying must be prepared to show the total number of Treasure Certificates received by the family and also to show the total number of "Treasure Top" designs reported in the family's entries (see Rule 1). Both the number of Treasure Certificates and the number of "Treasure Top" designs must agree with official contest records of the judging staff and these records will be considered final where any discrepancy occurs.

(c) The qualifying families will then be promptly notified and each family will be required to submit one statement of fifty words or less on the subject: "How the Sales of Pepsi-Cola Can Be Increased." They must get the help of their Pepsi-Cola dealer in preparing this statement and must submit that dealer's name and address. The Sweepstakes Prizes will then be awarded by the impartial judging staff, mentioned in Rule 5, on the basis of aptness, originality and sincerity of the statements thus submitted.

These contests are subject to all state and local laws and regulations.

HERE ARE THE BIG CASH PRIZES

FAMILY SWEEPSTAKES PRIZES:

1st Prize	\$25,000.00
2nd Prize	5,000.00
3rd Prize	2,000.00
4th Prize	1,000.00
5th Prize	500.00
15 Prizes	100.00 each

MONTHLY NATIONAL PRIZES:

1st Prize	\$1,000.00
2nd Prize	500.00
3rd Prize	250.00

MONTHLY PRIZES IN EACH STATE:

1st Prize	\$100.00
2nd Prize	50.00
3rd Prize	25.00
4th to 10th Prizes	each \$10.00
Near 41 Prizes	each \$5.00

ENTER HERE AND NOW!!!

PEPSI-COLA "TREASURE TOP" CONTESTS, P. O. BOX 18, NEW YORK 8, N. Y.

NAME _____

ADDRESS _____ (Please Print)

CITY _____ STATE _____

(Name of Head of Family)

PEPSI-COLA HITS THE SPOT BECAUSE _____ (25 Character Words or Less)

DEALER'S NAME _____ (Your dealer may use a special price if he has omitted you.)

and ADDRESS _____ (Be sure to include one "Treasure Top" with this entry.)

(Not necessary to use this block, but any sheet of blank will be sure your entry is complete in every detail.)

America's Best Wolf Traps Listed in Fashion Baedecker

By HAL BOYLE
 NEW YORK — (AP) — A lady who says she is a "beauty engineer" has done the traveling bachelor a favor.
 "She's come up with a list of ten cities where she says you can find the best dressed women."
 This baedecker of American style-conscious communities has been compiled by Mrs. Veronica Dengel, president of the American Women's Institute. Mrs. Dengel, who is 48, five-feet-eight inches tall and dark-haired, has written books on "Hold Your Man" and other problems of the married sex. Her institute does a mail order business in advice to fashion-lorn damsels who can't get to the big city.
 A poll of 800 fashion leaders throughout the country, she said, disclosed that the three cities with the lowest rating for well-dressed women were:
 (1) Boston — "Slow, too cautious, never catching up until fashion is well established."
 (2) Chicago — A mixture of good and bad fashion where East and West meet.
 (3) Palm Beach (yes, Palm Beach) — "Surrounded by beauty in clothes, but not properly affected by it" — whatever that means.
 Now to get on to the places where a fellow can make a date and be fairly sure the gal will show the most "ingenuity in dress, newness of style and wear proper fashions best suited" to her personality. Here they are in the order Mrs. Dengel lists them in her own

fashionable prose:
 (1) New York City — "The sophisticated new look" — Where women who are the nation's fashion leaders accept new styles and try them willingly.
 (2) Atlanta — "The soft southern look" — they couple smart fashion with southern grace and dignity.
 (3) Miami — "The provocative look" — they adapt the new and colorful in fashion to their colorful city needs.
 (4) Detroit — "The mature look" — the women are anxious to improve constantly in fashion consciousness just as their city is improving in its national importance.
 (5) Washington — "The refreshing look" — here the business girl proves it is possible to dress well on a budget when one plans carefully.
 (6) Philadelphia — "The pert look" — the quiet smartness of their city is reflected in the unerring choice of beautiful, wearable clothes.
 (7) Dallas — "The piquant look" — beautiful girls and beautiful clothes in a beautiful city.
 (8) San Francisco — "The intriguing look" — western charm with eastern flair for distinctive dressing.
 (9) Salt Lake City — "The wholesome look" — simple, casual living, in clothes with a fashion rightness.
 (10) Seattle — "The exciting look" — a plus quality in a city where everything seems to be a little "extra."

Anti-Red Peasants Seek U. S. Aid



The International Peasant Union, composed of former eastern European officials who fled their Communist-dominated countries, seeks the aid of the Western Allies in organizing an "international democratic front" to combat the Soviet Cominform. Leaders of the movement, pictured in Washington, are, left to right: exiled ex-Premier Ferenc Nagy, of Hungary; Stanislaw Mikolajczyk, of Poland; and Dr. G. M. Dimitrov, Bulgarian peasant leader.

Well, boys, there's where the best dressed clothes horses dwell — according to Mrs. Dengel and her poll pals. But they name no community where a man with a slim pocketbook can find a lass and keep her in the finery she wants to become accustomed to.
 Asparagus is a perennial plant which, under proper cultivation, will produce profitable crops for 10 to 15 years.
 There are some 140 species of octopuses.
Danes' Merchant Fleet Makes Quick Comeback
 COPENHAGEN — (AP) — Denmark's merchant fleet is making a quick recovery and has now reached 85 percent of its prewar size, totalling 956,000 tons. In 1946 the fleet made \$90,000,000 and this figure has been exceeded by at least \$10,000,000 in 1947.

LA Is Making The Law Stick On Juveniles

(From Amarillo News)
 LOS ANGELES — (Special) — Los Angeles County has a 10 o'clock curfew law, and juveniles are not allowed on the streets after that time. Sheriff Eugene Biscailus says this law is working effectively.
 The procedure is quite simple. Cars of uniformed and plain clothes sheriff's officers patrol an area of 400 square miles. In this area are some of the most congested districts in the county; some of these districts have as many as 200 thousand residents. Parents are given to understand that they are responsible for their youngsters on the loose after 10 o'clock at night. Violations result in the parents themselves being cited and fined or given warnings and suspended sentences. Parents can be thrown in jail, if such action is deemed necessary.
 The greatest hauls of youngsters have been near drive-in theaters. Here the officers move in on gangs, shake them down, take in suspected delinquents and send the innocents or juveniles home. Some drive-ins have been scrutinized sharply because of the chance that underworld peddlers may use these places to sell liquor or marijuana to children. Juveniles are not actually jailed and even the older children are not put behind bars to await arrival of parents. The tough ones are handled a bit more severely, but usually, says the sheriff, the parents bear down on their offspring when they learn that they themselves may get the works.
 Roundups usually bring in more boys than girls, but the girls play no favorites. Areas patrolled have many Negro and Mexican residents. Officers say that they do not have a great deal of trouble with Negro youngsters, but that some of the Negro adults are hard to handle.
 Sheriff Biscailus says the curfew law is a good one. He says there is no doubt that it has reduced juvenile delinquency and petty crime in many areas of the country.

Time Center Moves, But Time Goes On
 LONDON — (AP) — The world's clocks will not "go wrong" when the royal observatory at Greenwich on the Thames — official timekeeper for the world — moves to a new site 53 miles away.
 People from Alaska to Afghanistan will still set their watches by "Greenwich Mean Time," despite the fact that during the next five years the observatory will be moving, in stages, to Hurstmonceux, in Sussex.
 Master instruments will have to be adjusted to meet a change in longitude of 20 minutes. But the zero meridian, fixed by international agreement, will not be altered.
 The accuracy of Britain's Royal Observatory has for years been threatened by the "encroaching octopus of London." The city's smoke reduces atmospheric transparency and its electric lights have disturbed long exposure photography.
 The Russians certainly are not blameless for the cold war. But even if we should accept every charge made against the Russians it does not excuse an American policy which runs contrary to American principles.
 —Henry Wallace, outlining a program for European recovery.
 It is absolutely essential to have tax reduction this year.
 —Rep. J. W. Martin, Jr., (R) of Massachusetts.

St(lun Suit



Shirley Modell sports a new hair-do at Miami Beach, Fla., called the brow cluster which features a cluster of ringlets at the left side of the head. If you have time, you might also glance at her French-style, zebra-striped bathing suit, which is also new.

WHERE... BUT AT ANTHONY'S... Such Dress Values!



Happy Home DRESSES by Reliance

Advertised in LHM WOMAN'S DAY GOOD HOUSEKEEPING

5 Bright and Cheery At Home Styles At One Low Price

\$2.98

TOP
 A new kind of print ... this washable wearable Cotton Dress 14 to 42

Flower-bright fine quality printed cotton with becoming squared neckline and frothy frills. Adjustable waist ties securely in back. Sizes 14 to 42. Blue, Rose, Yellow.



RIGHT
 Floral Print Ruffled Skirt Dress

You'll feel as gay as you look in this carefree Happy Home cotton print. In goes the waist... out goes the skirt... flared at the very bottom with a swirly flounce. 12 to 20. Blue, Rose, Moize.



LEFT
 Zipper Floral Percalé 40 to 52

Gay ric-rac trims yoke, marches down the front of a slim front panel. It's a cute and capable Happy Home cotton print... in your favorite zipper front, with patch pockets, adjustable waist. Sizes 40 to 52. Blue, Rose, Turquoise.

Advertised in LHM WOMAN'S DAY GOOD HOUSEKEEPING

RIGHT
 Dotted Percalé Coat Dress 14 to 44

Frothy white ric-rac trails its crispy way down the front of this tiny polka dot print. It's a cute, capable cotton... it's a Happy Home. 14 to 44. Navy, Wine.



At Anthony's



The above Label is your assurance, price considered, that the finest of materials and workmanship are embodied in the garment displaying this Label.

This Label is your guarantee that the C. R. Anthony Co. guarantees this garment in every respect.



You'll Get Quality, and Smart Styling In Your Bryan Hall 100% Pure Worsted MENS' SUITS

Single or Double Breasted Styles **\$37.50** Others \$25.00 to \$42.50 Regulars Longs Shorts

It's Bryan Hall Red Label suit time at Anthony's. The new arrivals await your inspection. Bryan Hall Red Labels are styled in Single and Double Breasted models in colors of Blues, Browns, Greys and Tweed mixtures. The 100% Wool materials are fine quality hard twisted smooth faced worsted. Crease and wrinkle resistant. There are stripes, plaids, diagonals, solids and tweed mixtures. Sizes in Regulars 35 to 46, Longs 37 to 46 and Shorts 36 to 44.

Anthony's

Pampa Texas

Anthony's

Pampa Texas

Another Class In Business Training Set

Another class in distributive education will begin at the Chamber of Commerce on Tuesday night. It was announced yesterday by Miss Gertrude Fricker, instructor. Other courses have been conducted here for several days under the joint sponsorship of the Chamber, the University of Texas, division

of extension, and the State Board for Vocational Education. The course to begin this week will be "Selling Today," described as a practical study in the techniques of successful selling. Class demonstrations will be employed to dramatize the important parts of the course content. It is a refresher course as well as a course for the beginning. It was said. There will be a nominal enrollment fee.

"How to Train an Employee" is one of the latest 10-hour courses to be offered. It was stated that late-comers can enroll on the regular meeting night, Monday, at the Chamber of Commerce office and will have time to finish the course. All participants in all the courses that have been offered here have been notified that the "grand finale banquet" will be held at the Palm Room on Feb. 20, when certificates will be awarded.

"Customer Service in Beauty Shops" was one of the most recently completed courses—last Thursday night. There was 100 percent attendance from the Orchid Beauty Shop. It was said. After the meeting closed, the group had a dinner at Six's, guests of the beauty shop.

Twenty-seven persons are enrolled.

- We fix flats.
- 24-hour service.
- We pick up flats.

McWILLIAMS SERVICE STATION
424 S. Cuyler Phone 27

Kodak Finishing PHOTOSTATS ENLARGING

B-E Photo Service
218 1/2 N. Russell Ph. 1047

Lost Our Lease

Our temporary headquarters, the new Masonic Building, 420 W. Kingsmill.

Firestone Stores

in the course "The Variety Store Selling," which meets daily from 5:45 to 6:45. Miss Price said attendance from both variety stores here was excellent. Gov. Beauford Jester has proclaimed Feb. 1 to Feb. 7, as "Distributive Education Week" in Texas. His statement said members of the Associated Distributors Clubs of Texas and the Associated Distributors Clubs of America "hold as their primary aim the development of a high degree of leadership and citizenship in the students of today who are destined to take their place as tomorrow's leaders in the distributive business."

Lubbock Names New City Manager

Marlin R. Smith, Lubbock, was named city manager of Lubbock, last week by the Lubbock City Commission. Smith, associated with the consulting engineering firm of Parkhill, Smith and Cooper, represented that concern here several weeks ago when the Pampa City Commission called for bids on a future water supply survey. Smith was one of the unsuccessful bidders. The contract was awarded to Roberts and Merriman.

Smith succeeds Homer A. Hunter who resigned to enter private practice in civil engineering at Dallas. Today is what you were looking forward to yesterday—and it's your own fault if you are disappointed.

Used Car Dealers Ask Price Control

WASHINGTON.—(AP)—Oliver W. Wood, president of the National Used Car Dealers Association, has asked Congress to prohibit the sale of a used car at a higher price than a new car of the same make and model. He also told the Senate Banking Committee that price ceilings should be put on new autos. Wood said his association includes 5,000 of the nation's 35,000 used car dealers. It favors government price controls, he said, for this reason: "It fears that if prices keep going

up, automobiles will get beyond the reach of great numbers of buyers. Then used car dealers will be stuck with a lot of high-priced cars they can't sell. The committee, headed by Senator Tobey (R-N.H.) is considering proposals to fight inflation. When Wood urged price controls, Tobey exclaimed: "Will somebody get me some ammonia? I'm about to faint. You're the frankest witness we ever had. This is wonderful." Understanding the control which safe in the Lions' den, and Paul Love held over all, Daniel felt proved the viper to be harmless. —Mary Baker Eddy

Local Man Will Study Marketing

Frank Fata, who recently became associated with the Equitable Life Insurance Society of the United States, left last night for SMU at Dallas, where he will start the first in a series of insurance marketing studies which will require a year to finish. He will be away for five weeks, will return here, and then return for a 10-week course. He said he would be making those periodic studies until he had finished a year's work.

PHARMACY IS OUR PROFESSION

FOR RENT—Wheel Chairs, Bed Pans, Crutches, Baby Scales. Free Prescription Delivery

PRESCRIPTION LABORATORY
119 W. Kingsmill Phone 1920

PORTRAITS
KODAKS—COMMERCIALS

Smith's Studio
132 W. Foster Phone 1510



DOLLAR DAY

AT ZALE'S

2-Pc. Silverplate Baby Spoon and Fork Set \$1.00	BABY RINGS SOLID GOLD Clover Leaf Design 69¢
Baby Spoon Silver Plate Curved handle 50¢	Fruit Juice Glasses Set of 8 Four Beautiful Colors \$1.50
PEARLS Beautifully Matched Single strand \$1.00	COMPACTS Gold Finish Engraved Design \$1.50
ANKLETS Sterling Silver Engraving Free 95¢	Sugar and Creamer Satin-tone Colors 2-Piece Set \$1.95
Demi-Tassi Cups and Saucers 2-Piece Set \$1.50	Punch Bowl Sets Large Size 15-Pc. Service for 12 \$7.95

One Especially Selected Group Of Fine Costume Jewelry **1/2 PRICE**

All Gift Cards At One Half Regular Price

ZALE'S
107 N. Cuyler

Shop Early And Save

DRESSES
From our regular stock.
Regular values to \$39.95
Many Evening Dresses Included
\$8

FINAL CLEARANCE SUITS
Just 12 suits only!
Values to \$89.95.
\$25.00

ROBES
Satin - Quilted - Crepes
Sizes 10 - 20
Values to \$29.95
\$10

Don't Miss
The Top o' Texas Revue
Junior High Auditorium
February 2nd and 3rd

SATIN Brassieres
Uplift style. Tearose, white.
Regular \$2.98 value.
\$1.98

Panties
Tearose only.
Regular \$1.00 value.
50¢

Blouses
Jerseys! Crepes!
Regular values to \$5.95
\$1.98 and \$2.98

Sweaters
High shades! 100% all wool!
\$1.98

Skirts
\$1.98
And **\$2.98**
Values to \$8.95

Gowns
\$1.98
And **\$2.98**
Values to \$6.95

AT BEHRMAN'S
Make your Dollar go further at BEHRMAN'S. New merchandise, combined with quality and value, means bargains at BEHRMAN'S.

DRESSES
Sheer for year around wear.
Sizes 7 - 20
Regular values to \$22.95
\$5

FINAL CLEARANCE Dresses
Well Known - Nationally Advertised
REGULAR VALUES TO \$69.95 **\$19.95**

NEW DRESSES
Blacks, navys and beautiful spring shades. New styles.
Regular values to \$39.95
\$12

SLIPS
Black and White Combination
Whites and Blacks
\$1.98

BEHRMAN'S

"Exclusive But Not Expensive"

Masquerading Their Happiness



Harold Russell, handless Army veteran who won an "Oscar" for his performance in "The Best Years of Our Lives," and his wife smile happily, behind their surgical masks, as he meets their new 7-pound, 8-ounce daughter—Adele Pitt—in Cambridge Mass.

Energetic United Nations Official Will Head Palestine Commission Staff

A tan leather dispatch case, bearing the name of Ralph Bunche, looks simple enough on a desk at United Nations Headquarters. But it carries some of the world's most important papers—U. N. plans for the future of Palestine as separate Jewish and Arab states.

The owner of that dispatch case, a stocky, athletic-looking man with an easy smile, will be a key figure during the months ahead when the U. N. Palestine Commission sets up the unprecedented new nations in the Holy Land. For Ralph J. Bunche, principal secretary of the Commission, is the Commission's right-hand man, executor of its decisions and director of its staff.

With a vitality stemming from college athletics, the 43-year-old international civil servant pitched into his new work on Palestine. In little more than a month, he has completed the organization of his staff, begun making careful plans for U. N. work in Palestine and is already aiding the Commission in its meetings.

Dr. Bunche—he holds a Ph.D. from Harvard University—has been working with the Palestine problem since it was brought before U. N. early last year. He served then in an important post with the U. N. Special Committee on Palestine, whose report was



DR. RALPH J. BUNCHE

the basis of the decision to partition the Holy Land.

However, Dr. Bunche's regular assignment is in what he calls his outstanding specialty—problems of non-self-governing people. He is Director of U. N.'s Division of Trusteeship, which deals with Trust Territories. Ever since he was an undergraduate (and an outstanding basketball, football and baseball player) at the University of California at Los Angeles, Ralph Bunche has been studying international relations and colonial administration. When he was working on his advanced degree, however, he explored a new field in political science by actually studying the cultures and lives of colonial peoples appraising the impact of colonial policies on them. The result was a blending of anthropology with political science.

His studies as both student and teacher took him to far corners of the earth, to Africa, the Southeast Asia and Europe. In 1928, he became head of the Political Science Department at Howard University in Washington, from where he has been on leave of absence for six years.

Dr. Bunche left Howard to work in the United States Office of Strategic Services and later in the Department of State and participated in all of the preparatory conferences of the United Nations. He then joined the U. N. Secretariat.

When he is not putting in long hours on his U. N. duties, Dr. Bunche enjoys the company of his family, which includes two daughters and a son. He enjoys dramas and musical comedies, likes the music he began to appreciate in a musical family during his childhood and favors historical novels and detective stories.

Spite Spoils This Silver Wedding

COPENHAGEN —(AP)—A farmer and his wife in the Danish village of Ulaev sat waiting for flowers and gifts on their silver wedding anniversary, but only a few closest members of the family appeared, bringing no gifts.

On the following day they learned that the local paper had had an advertisement announcing that the couple wanted their anniversary "passed over in silence."

Police found the advertisement had been inserted by a near relative who was at odds with the farmer over a division of an inheritance.

Prostitutes' Round-Up

WARSAW —(AP)— Militiamen rounded up and registered 800 prostitutes. Ninety-nine percent of the women were found to be suffering from venereal disease.

Sure This Wasn't A Flying Squirrel?

MOSCOW —(AP)— Ever hear of a tree-climbing fox? Two Moscow hunters not only heard of one, but took a photograph to prove it. The Evening Moscow reported the two nimrods followed their dog for two hours. They were astonished when he stopped before a tree and started barking up it (the bark).

There was the fox at the very top of the tree. They felt no one would believe them so they whipped out a camera and shot the fox for posterity.

Then they took out their guns and shot the fox for supper.

We cannot rush to diaper every squalling problem all over the face of the earth.

—Sen. Eugene Millikin (R) of Colorado.

LOANS

• Automobile • Truck • Household Furniture and Other Personal Property

WE WILL LOAN YOU MONEY TO COMBINE ALL YOUR OBLIGATIONS

We Loan On ANY Good Collateral

H. W. Waters Insurance Agency

208 N. Russell Phone 339



EVER HAD THIS **BIG 3** CHECKED, CLEANED, SERVICED? FUEL PUMP: A fuel pump check-up stops trouble before it happens. FUEL LINE: Cleaning fuel lines now prevents on-the-road trouble later. CARBURETOR: A thorough check-up, adjustment and cleaning saves fuel, improves performance. **Nash Synthetic Oil SERVICE IS BEST FOR YOUR CAR REGARDLESS OF MAKE** Boyles Nash Co. 114 S. Frost Phone 130 300 S. Cuyler Phone 600 READ THE CLASSIFIED ADS.

Japan Temple Unions Have a Yen for Yen

TOKYO —(AP)— It's a new day for labor in Japan, and most unions have little trouble extracting what they want from the boss, but consider the sad plight of the boys who organized the temples.

The temples don't make money, what with patrons poorer and the Shinto subsidies flown out the window.

Take the 270 employees of Shinshoji temple. The carpenters, janitors, gardeners, clerks and telephone operators organized two years ago. They've been bargaining

and bargaining, and all they've got to show for it is a little charcoal and firewood a month for each family.

The pay still averages 1,400 yen a month, just what it was two years ago—and that's 400 yen less than what the government considers a liveable minimum.

Monkey Siamese Twins

SINGAPORE —(AP)— A freak of nature was reported from up-country Malaya, where a plantation employee discovered newly-born monkey Siamese twins. Both died after one day.

READ THE CLASSIFIED ADS.

SENSATIONAL SILVER VALUES FOR \$ DAY

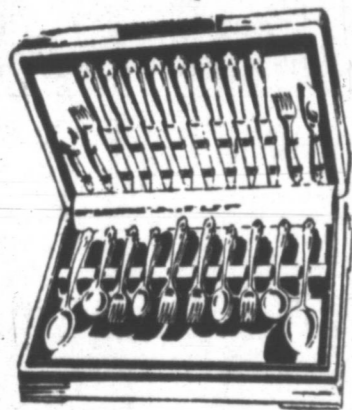

51 PIECE SILVER SET BY ROGERS AND BROS.

The original Rogers Silver Plate Made by International Silver Co.

Tarnish Proof Chest Free

In the Beautiful Inspiration and Rapture Patterns

SET INCLUDES	All	34.50
8 Dinner Forks	51	
8 Dinner Knives		
16 Teaspoons	Pieces	
8 Salad Forks	Only	
8 Soups		
3 Serving Spoons		Tax Included



Here is a Real BARGAIN Beautiful Plated Silver Salt & Pepper

DOLLAR DAY ONLY \$1.19 A Pair

Holmes & Edwards Baby Spoon and Fork Set \$1.75

Silver Plated Baby Cups \$1.75

LEDER'S JEWELRY

112 N. Cuyler Phone 960

DON'T WAIT SAVE on Furniture NOW BUY THESE DOLLAR DAY VALUES

LOOK! SPECIAL GROUP

LARGE ASSORTMENT OF CHENILLE BATH MATS

ONE GROUP NICE TABLE LAMPS

ONE GROUP OF TWO-BURNER ELECTRIC HOT PLATES

DEMONSTRATOR MODEL KAISER DISH WASHER

LARGE ASSORTMENT OF LAMP and END TABLES

OUR ENTIRE STOCK OF OVER-NITE CASES

ALUMINUMAIRE CARPET SWEEPERS

SOLID OAK UNFINISHED DINETTE CHAIRS

SOLID WOOD LARGE POSTER BED

1 / 2 OFF

Extra Special For Dollar DAY

Baby Auto Seats	\$1
Values to \$3.95—While They Last	
Beverage Sets	\$1
With Tray. Regular \$3.95—Dollar Day	
Vanity Sets	\$1
Values to \$4.95—Dollar Day	
Mirrored Jewel Boxes	\$1
Values to \$4.95—Dollar Day	
Child's Redwood	
ROCKER Values to \$3.95	Dollary Day \$1
Wood Folding Chairs	\$3.95
Values to \$5.98—Dollar Day	
ALL RADIANT HEATERS	1/3 OFF

WHILE SHOPPING BE SURE To See These NEW ARRIVALS

- Clothes Hampers. Large assortment of colors and sizes.
- National Advertised BORG Bathroom scales.
- Waterbury Wind-Up Alarm Clocks.
- Westinghouse Barbage Disposal Units.
- All wool rugs. New patterns. Assorted sizes.
- Large Stock of Genuine Inlaid Linoleum.
- Western Holly Gas Ranges. Immediate Delivery.

FLASH! FLASH!

We have been waiting several years to bring you this news. They won't last long, but come in and see—

ELECTRIC REFRIGERATORS FOR IMMEDIATE DELIVERY

Norge-Westinghouse & Coolators

FIRST COME, FIRST SERVED. NO EXTRAS — NO TRICKS — IT'S TRUE, THEY ARE HERE.

WHERE THE HOME BEGINS

Pampa Furniture Co.

120 W. FOSTER FRANK FOSTER, Owner PHONE 105



THE NUISANCE

OUR BOARDING HOUSE with Major Hoople



APPLYING THE NEEDLE



SIDE GL/ BY GALBRAITH NAPOLEON



"I don't know why I'm so hungry tonight—those two bowls of chili I ate on the way home must have been an appetizer!"

Discoverer

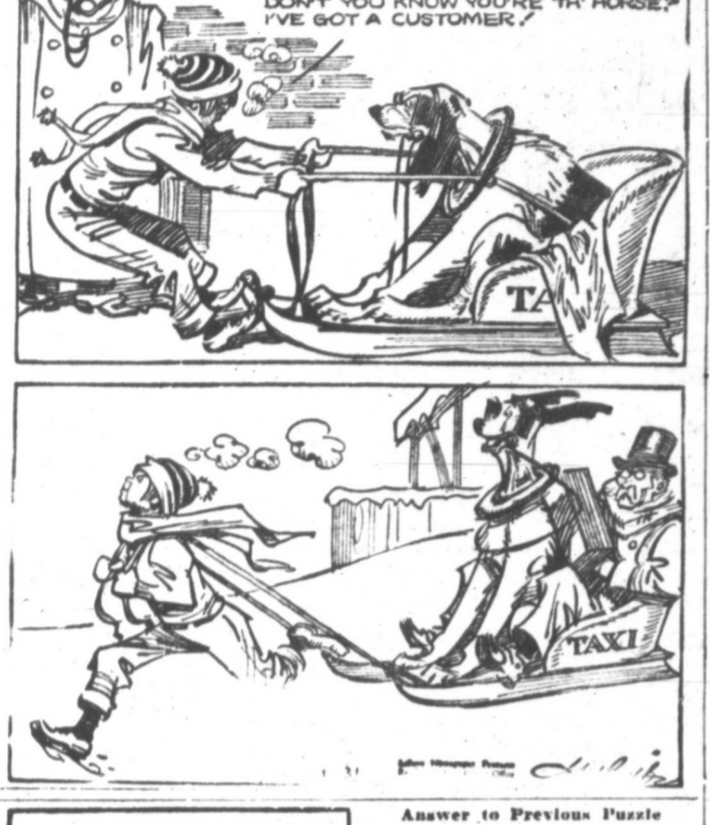

- Answer to Previous Puzzle
- | | | | | | | | | | | | | | | | | | | | | | | | | | | | | | | | | | | | | | | | | | | | | | | | | |
|--|---------|----------|---------------------|-----------|--------|-----------|----------------|---------|-----------------|-----------------------|------------------|-----------------|-----------|----------------------|-----------|----------------|-------------|-----------|----------|-------------|----------------|-----------|-------------------------------|------------------|-----------|------------|------------|----------|-------------------------------|-----------------|------------------|-------------|----------------|-----------------|-----------------|------------|------------------|-------------------|-----------------------|-------------------------|-----------------|----------|----------------|-----------------|-----------------|------------|------------------|-------------------|
| 1 Pictured discoverer of the X-ray, Wilhelm Roentgen | 2 Bones | 3 Heroic | 4 Symbol for nickel | 5 Handies | 6 Bile | 7 Seventh | 8 Greek letter | 9 Seine | 10 Fails to hit | 11 Symbol for iridium | 12 Tealadie tale | 13 Short jacket | 14 Peruse | 15 East Indies (ab.) | 16 Rodent | 17 Land parcel | 18 Quagmire | 19 Knocks | 20 Exist | 21 Reversal | 22 Society for | 23 Camper | 24 Want of water search (ab.) | 25 Corded fabric | 26 Flower | 27 Ireland | 28 Auricle | 29 Exist | 30 Blackbird of cuckoo family | 31 Narrow inlet | 32 Cloth measure | 33 Reversal | 34 Society for | 35 Physical Re- | 36 Search (ab.) | 37 Article | 38 Earth goddess | 39 Medical suffix | 40 Spring fast season | 41 Symbol for tellurium | 42 Denomination | 43 Wings | 44 Savage fear | 45 Physical Re- | 46 Search (ab.) | 47 Article | 48 Earth goddess | 49 Medical suffix |
|--|---------|----------|---------------------|-----------|--------|-----------|----------------|---------|-----------------|-----------------------|------------------|-----------------|-----------|----------------------|-----------|----------------|-------------|-----------|----------|-------------|----------------|-----------|-------------------------------|------------------|-----------|------------|------------|----------|-------------------------------|-----------------|------------------|-------------|----------------|-----------------|-----------------|------------|------------------|-------------------|-----------------------|-------------------------|-----------------|----------|----------------|-----------------|-----------------|------------|------------------|-------------------|

CARNIVAL BY DICK TURNER



"You may as well give up, Holcomb! I tell you she's going to marry ME for MY money!"



Divorces Granted In District Court

Two divorces were granted Friday in District Court by Judge Lewis M. Goodrich: Milton Stanford vs. Rudell Stanford, married in Dec., 1945, separated in Oct., 1947; grounds, cruelty. Velma C. Meador vs. S. J. Meador, married in Oct., 1917, separated in Dec., 1947; grounds, cruelty.

A child 12 years old requires about twice as many calories in his diet as a child three years old.

Chicago Papers Use Operation Musk Ox

By MARION BURSON
CHICAGO—(AP)—One newspaper calls it "Operations Musk Ox"—this job of getting out papers without printers. Perhaps it's because the Musk Ox is a slow and cumbersome animal. But getting out Chicago's six major daily newspapers currently is not nearly as slow and cumbersome as it was in the days immediately following a walkout of union printers last Nov. 26. With the strike beginning its third month, the Chicago dailies—The Daily News, The Tribune, Journal of Commerce, Herald-American, Sun and Times—continue to roll from the presses. Readers generally agree the papers are more readable than when type-written copy, reproduced by the photo-engraving process, first was introduced at the start of the strike. Another thing—it's taking less time to get late news into the papers. Methods used by the various newspapers differ in details but generally this is how it's done in each plant: Instead of being sent to the composing room, news stories and advertising material, prepared in the usual manner, are routed to a battery of typists. Some ordinary typewriters are used but most now are electric, use a ribbon of carbon paper and offer a variety of type faces. The typists copy the material, usually in column or two-column widths. They copy news item or piece of ad copy twice to make the lines come out even along the right hand margin. Headlines for the news stories are made up in the usual department. The letters for the heads are pasted up one by one. After the headlines are assembled, transparent tape is used to fasten them in place. Before a newspaper can be published the rotary press cylinders must be supplied with curved metal printing plates. These are made from matrices—page size sheets of a cardboardlike material baked to a crisp hardness and containing impressions of everything that is to go on the newspaper page. Under normal conditions, the matrix, commonly called mats, gets its impressions from the type matter composed on the Linotype machines. However, the men who run the Linotype machines are out on strike in dispute over a new contract. They are about 1,500 members of Local 16, AFL International Typographical Union. So now the impressions on the mats come mostly from zinc engravers and halftones. A makeup editor matches each typewritten story with its headline and pastes them on a sheet of cardboard the exact size of a newspaper page. Then the whole thing is photographed. A zinc engraving is made from the negative. The mat is taken from the engraving. But engraving takes considerable time. One paper figures that to get an engraved story in the paper requires three hours and 10 minutes. This is what is called line engraving. A modification of this process is the halftone engraving, which is the way pictures ordinarily are reproduced. It saves perhaps an hour to an hour and one-half. In the paper, a story in halftone appears as black lettering on a gray background. However, a still faster method has been devised for news bulletins. This involves use of an addressing machine, which stamps out embossed, or raised letters on a small metal strip. After a bulletin has been stamped on it, the thin metal strip, supported by a cushion of plaster

Are You Provoked?



This photograph of Hazel Brooks, Hollywood actress, was voted "Most Provocative Still of 1947" by the International Society of Photographic Arts. It was made by Durward Graybill.

Paper Moves To New Home

MIDLAND—(AP)—The Midland Reporter-Telegram has moved into its new home, a modern plant built on the site of Midland's first newspaper. New equipment includes a 16-page Duplex tubular press, capable of printing 20,000 papers an hour. The move was made without missing an edition. The new plant is located at 221 North Main Street, the site where the Staked Plains began publication before the turn of the century. James N. Allison is publisher of the Reporter-Telegram. He purchased the paper in 1940 after 14 years with the Associated Press in the Mid-west. The new plant, started last summer, is of brick, steel and concrete construction and fireproof throughout. It is one of the most modern newspaper buildings in the Southwest. The 50 by 140 foot structure was designed and built for newspaper efficiency. New furniture and equipment has been installed throughout the front offices. The new press, which replaces an eight-page flatbed, is the latest type printing equipment available. It was received from the Duplex factory in Battle Creek, Mich., early in January, and other new equipment includes stereotyping equipment, a tubular plate router, a May roller, a vacuum casting box, an additional linotype machine, and other composing room machinery. Allison said a formal open house will be held at the new plant sometime in February. "Everything possible has been done to make the plant the most complete and most modern in West Texas," the publisher said.

OUTWIT THE WEATHER WITH A NEW ROOF!

Protect your biggest investment—your home—with a new roof. Save it from serious water damage due to rains and storms. Talk over Wood Shingles—Asphalt Shingles and Roll Roofing with our experts this week.

PANHANDLE LUMBER CO., Inc.
420 West Foster Phone One Thousand

YOUR FAMILY THEATRE

REX ADMS 35¢

DOUBLE FEATURE
Feature No. 1 at 1:00, 3:50 6:40, 9:30

Roy Acuff and His Smoky Mountain Boys and Girls in "Hi, Neighbor"

Feature No. 2

Weaver Brothers and Elvira in "Tuxedo Junction"

Feature at 2:15, 5:05, 7:55, 10:45

Also Cartoon "Two Gophers from Texas" & News

CHOOSE THE MAIN MOVIES

CROWN ADMS 25¢

TODAY and MON.

RETURNED FOR YOUR PLEASURE

GARY AND JEAN'S GRANDEST LOVE STORY!
GARY COOPER
JEAN ARTHUR
in Cecil B. DeMille's **"The Plainsman"**
with **CHARLES BICKFORD**
JAMES ELLISON

TODAY thru TUES.

LANDORA ADMS 44¢

FEATURES AT 1:47 5:44 8:46 7:45 9:40

Romantic Adventure In Early California!

Maria Montez in "Pirates of MONTEREY"
in Technicolor with **ROD CAMERON**

ALSO COLOR CARTOON & UNIVERSAL NEWS
CHARLEY BARNETT AND HIS ORCHESTRA

Cabot Couple to Live at Pampa

Mr. and Mrs. Louie Cabot and their small son are scheduled to arrive in Pampa to make their home as soon as a house can be found for them, it was learned this past week. The Louie Cabots live at this time in Boston. Mr. Cabot has been attending Harvard School of Business Administration. He worked with the Cabot Companies here for about two months in the summer of 1946. His return here, it was said, will be to take general training with the company which bears his family's name.

Legal Records

Marriage Licenses
A marriage license was issued yesterday in the office of County Clerk Charlie Thut to Ed S. Johnson and Earle Janice Belk. A license was issued Friday to Ernest Henry Hoyer, Jr., and Betty Jo Ward.

Realty Transfer
J. W. Garcia and wife, Angela Garcia, to T. R. Tipples lot 2 in block 10, South Side Addition. Suit Filed

Filed yesterday in the office of District Clerk Dee Patterson was the injunction suit of W. J. Ball, et al. vs. State Highway Commission, et al.

Dee Patterson Files For Re-election

Dee Patterson today authorized the Pampa News to announce her candidacy for re-election to the office of Clerk of the District Court, subject to the Democratic Primary Election. Mrs. Patterson, in seeking her third term, points to her experience and ability as the factors to be considered in re-electing her to office. Mrs. Patterson solicits the vote and influence of all voters in the county in the coming election. (Political Advertisement)

SHOP PENNEY'S DOLLAR DAY FOR EXTRA SAVINGS?

DRESSES REDUCED

Early spring styles drastically reduced to clear—

5.00

Spun Rayon **DRESSES**

Buy Several at This Giveaway Price **1.00**

WOMEN'S SHOES
All reduced from regular stock Don't miss this saving **2.00**

CHILDREN'S DRESSES
Cottons, Rayons and wools. Priced at a fraction of their original cost **2.00**

CHENILLE ROBES
Special purchase for Dollar Day. They come in white, gold, rose, aqua **4.98**

BOY'S 10-OZ. DEMIN JEANS
Extra heavy weight denim. Copper riveted at points of strain **1.98**

COMPACTS BY REX
200 at this low price. Smart new shapes **1.09**

FAST COLOR PRINT
A grand collection of new spring patterns **39¢**

TERRY TOWELS
22x44 plain color or plaid designs **49¢**

MEN'S DRESS SHIRTS
Topflights in pre-war quality are back. Sizes 14 to 17 **2.49**

CHENILLE BEDSPREADS **6.90**
So Easy to Care For!
They're lovely, luxurious! They stay fresh through washing after washing! And they're so easy to care for... require no ironing, simple to wash! White or pastel ground with multicolor design. Preshrunk!

MORE AND MORE. THE TREND IS TO PENNEY'S



Fashion Plate for '48

BUICK'S the one and only

WITH ALL THESE FEATURES:

- * DYNAFLOW DRIVE
- * TAPER-THRU STYLING
- * VIBRA-SHIELDED RIDE
- * SAFETY-SIDE CURBS
- * HI-POISED FIBREBALL POWER
- * ROAD-BITE BALANCE
- * RIGID TORQUE-TUBE
- * GUARDFLEX COIL SPRINGING
- * FLEX-FIT OIL SHIELD
- * SOUND-INSULATED LINING
- * DYNAMIC SPARK ADVANCE
- * TEN SMART MODELS
- * BODY BY FISHER

BUICK takes the bows—with ten sparkling models, a new Vibra-Shielded ride, sensational Dynaflow Drive, 30-odd new advances

The curtain's up—the show is on—and square in the spotlight of public favor is this fashion-plate Buick. This bonnie, brawny beauty is taking bows for the eye-appeal of its ten stunningly-smart models... Catching bouquets on the utter brilliance of Hi-Poised Fibreball Power... Getting applause for Safety-Ride rims, pillow-soft tires, all-coil springing—for bodies newly sheltered against disturbing noise—for no less than 30 new features. And it's winning curtain calls on two major advances no other car offers. One is the fabulous new Dynaflow Drive* where there is no gearshift, even automatically. You just step on the gas—and motoring close to magic is yours. Other star feature is the Vibra-Shielded ride. Here for the first time you're shielded against vibration build-up that brings on fatigue. Here no tiny tremors can harmonize into big ones. Here is living-room comfort and quiet. Your Buick dealer is showing this fashion plate that's touched with magic. See it. Check it for spaciousness, for solid-feeling steadiness, for superlative finish, fittings and fabrics. Then—to get one into your garage at the earliest possible date—get your order in now.

TEX EVANS BUICK CO.
117 N. Ballard Phone 125
WHEN BETTER AUTOMOBILES ARE BUILT BUICK WILL BUILD THEM



Just this one last reminder. The APT dance is February 6 at the Southern Club and since this is one of the big affairs of the year you sure don't want to miss it. Admission to the dance can only be acquired by obtaining a membership in the APT which costs you \$1.00. The ticket to the dance is \$1.50 per couple... which means that for \$2.50 you can become a member of a fine progressive organization and also attend a dance for an evening dancing to the music of R. E. Smith's orchestra, one of the largest in the Panhandle. If you haven't been contacted about your tickets as yet, contact F. E. Kennedy at Standind or if you'll contact yours truly at 666 I'll be glad to oblige you with same.

A. E. (Chick) Hickman, former district manager for the Bethlehem Supply Company, with headquarters in Pampa, recently resigned to form the Petroleum Specialty Company. The new company has purchased the property at 902 West Brown in Pampa, and is now principally engaged in the manufacture and installation of a product known as the "Crall Spiral Paraffin Scraper". The steel spiral product is installed on sucker rods and placed in oil pumping wells to prevent the accumulation of paraffin in the tubing, thus assuring uninterrupted service. Chick has acquired many friends around over the country during his many years of connections in the oil industry and these same friends are wishing him the best of luck in this new venture which incidentally is growing steadily, with new employee additions at regular intervals. Chick is also well known for his tenor voice which has enhanced many a quartette in and around this territory in the past and present. Right now Chick is a member of the very popular Squeaky Door Four.

Really, folks, all I had last week was a bad cold. The type got a little jumbled in last week's column just as it got to the point where I was trying to explain about it, consequently the name of my affliction brought about a few questions from the medical profession who were a little confused about the malady. Shell Notes. Mrs. S. N. Crowley left Tuesday for Fort Lavinco, Texas, to be at the bedside of her mother who is reported to be seriously ill. Otho Robb, of Greenwich, Kansas, was transferred to the Pampa District

last Tuesday to work on the North End of the Panhandle District. His wife will join him this week and they will reside on Barnard Street. J. W. Swygart, local district superintendent for Shell, will leave this afternoon for Tulsa to attend a three weeks conference with other superintendents. W. Roche, division manager of Shell, accompanied by F. McGweehon, division chief clerk, Wichita Falls, spent Wednesday and Thursday in Pampa transacting company business. E. O. Van Winkle, pumper on the E. Lucas lease, has just returned to his home from a siege in a local hospital. Efton Teel and Frank Whyman, representatives of the Gas-Gasoline department of Tulsa spent several days in Pampa transacting company business. Mrs. Tim Crossfield, wife of Shell pumper on the Harvey Sisters lease, has been confined to the hospital as a surgical patient at Excelsior Springs, Mo. Her condition is reported very good and she will return home the latter part of this week.

Standind changes. This area has been made the Panhandle District rather than an area with L. E. Sloan appointed district superintendent. Leo Fryc is now a district engineer. Clarence Kaura, promoted to district clerk from field clerk, has been transferred to the Gulf Coast area and Dick Weaver has been transferred here from that area. Henry Mason, assistant field clerk has been transferred to Wink, Texas, while R. H. Lee Davis has been transferred here from the Wink office to act as assistant district clerk here.

May I say again that we appreciate these news items from the various companies. If yours is not listed why not see to it that your company is reported to this office. It's as simple as dropping a card or calling Ken Bennett at 466, The Pampa News.

Federal Highway Program Bolstered
WASHINGTON—A state highway engineer of Texas asked Congress Friday to continue the federal-aid highway program indefinitely at \$500 million a year. D. C. Greer of Texas told a House subcommittee the 1944 highway act has been a blessing to Texas rural areas. He said the state has built 5,000 miles of dustless farm-to-market roads under the program. The subcommittee is conducting hearings on a proposal to extend for three years the 1944 program which authorized federal grants of \$500,000,000 a year for three years, to be matched equally by the states. Although barnacles thrive best in warm waters, they can survive long trips to comparatively cold regions.

Oil News

PAGE 10 Pampa News, Sunday, February 1, 1945

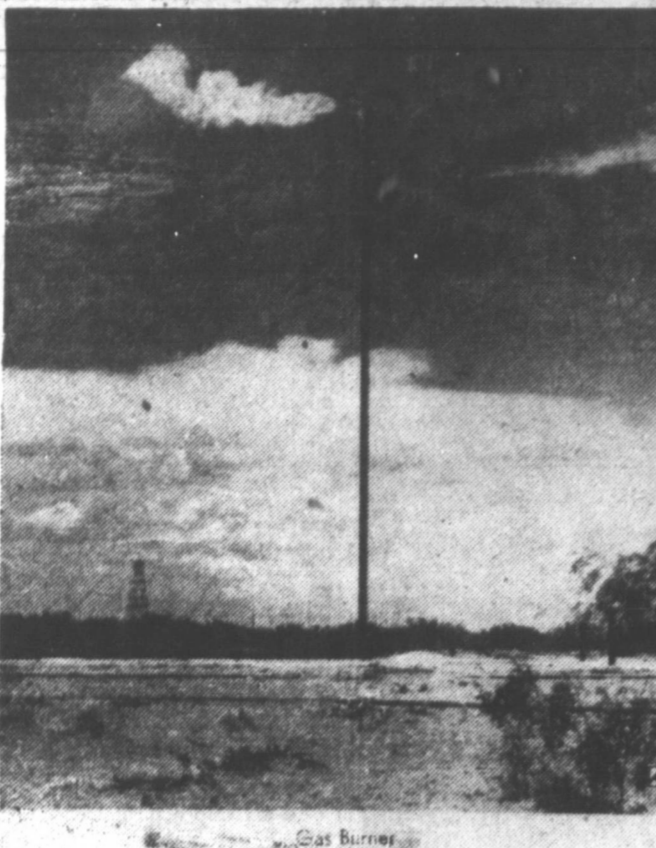

This oil field flare, needling 80 feet into the sky, is a landmark near Grandfall, Texas. The gas pressure was once so great the heat killed vegetation on the prairie around it and a newspaper could be read at night three miles away. Moderated now, it still serves as an insect trap and a light by which birds seek food at night. In bitter weather cattle bed down under the flare for warmth.

Twenty-Six Notices of Intent to Drill Filed With Commission

Twenty-six notices of intent to drill were filed at local oil and gas office of the State Railroad Commission during the past week officials reported yesterday. This is the largest group of filings for a considerable length of time. The same report listed eleven wells as having been plugged. Hutchinson County reported twelve notices of intent to drill. Gray County reported eight. Notices of Intent to Drill. Carson County—Frank H. Yealy, Noel No. 1, I&GN Survey, 430' from S and 400' from E lines of W/2 SE/4 Sec. 24, Blk. 3, 3 miles W of Pampa. Gray County—Johnston Oil & Gas Company, Lovett No. 2, I&GN Survey, 900' from S and W lines of SW/4 Sec. 57, Blk. B-2, 4 miles W of LeFlore. Phillips Petroleum Company, Glascock No. 1, I&GN Survey, 210' from N and 1650' from E lines Sec. 16, Blk. B-2, 10 miles SE of Pampa. Phillips Petroleum Company, Lehman No. 2, I&GN Survey, 1650' from N and 210' from E lines of Sec. 16, Blk. B-2, 10 miles SW of Pampa. Magnolia Petroleum Company, Raymond No. 10, Sec. 12, Blk. 3, I&GN Survey, 4 1/2 miles W of Pampa. Gas Completions. Carson County—Hagy, Harrington & Marsh, Powers No. 1, Sec. 232, Blk. B-2, H & GN Survey, Potential 1,450 MCF. Rock pressure 370. Moore County, J. M. Huber Corporation, Russell Fuller No. 1, Sec. 135, Blk. 3-T, T & NO Survey, Potential 6,400 MCF. Rock pressure 401. Sherman County, Shamrock Oil & Gas Corp., Horner No. 1, Sec. 8, Blk. 2, Public School Land Survey, Potential 7,150 MCF. Rock pressure 422.

Phillips Has Completion

Only one new oil well was reported completed this past week according to a report from the local Oil and Gas Office of the Railroad Commission. The Phillips Petroleum Company, No. 2 Kroner, located 330 feet from N and W lines of Section 105, Block B-2, H & GN Survey, tested 72 barrels of oil in a 24 hour test. Top of pay 5195 feet. Total depth 3240 feet. Three new gas wells were reported as completed. One was reported in Carson County, one in Moore County and one in Sherman County.

CENTENARIAN—On Feb. 12 Corsicana will be 100 years old, and the town is going to celebrate. Civic and city officials decided to appoint a committee to prepare for a centennial observance, to be held some time during the year.

Plugged
Carson County—Cree Production Company, C. E. Garner "A" No. 1, Sec. 94, Blk. 4, I&GN Survey, Located 2 miles W of Skellytown. Plugged 9-10-47. Total Depth 3164'.
Carson County—L. A. Helms, Adde Holland No. 2, Sec. 17, I&GN Survey, Located 3 1/2 miles SE of White Deer. Plugged 2-7-47. Total Depth 3200'.
Hutchinson County—J. M. Huber Corporation, Midstate State No. 1, Sec. 17, Blk. 47, H&T Survey, Located 8 miles NE of Berger. Plugged 1-1-47. Total Depth 2745'.
Hutchinson County—Sinclair Prairie Oil Company, J. A. Whittenburg No. 1-B, Mary Whitley Survey, No. 1, G.H. & H Survey, 2640' from S and E lines Sec. 54, Blk. 2-B, 10 miles SE of Stratford. Phillips Petroleum Company, Etelle No. 1, G.H. & H Survey, 2640' from E and W lines Sec. 50, Blk. 1-C, 6 miles SE of Texoma.
Carson County—Perkins-Prothro Company, S. H. Burnett No. 8, Sec. 11, Blk. 5, I&GN Survey.

Plugged
Carson County—Cree Production Company, C. E. Garner "A" No. 1, Sec. 94, Blk. 4, I&GN Survey, Located 2 miles W of Skellytown. Plugged 9-10-47. Total Depth 3164'.
Carson County—L. A. Helms, Adde Holland No. 2, Sec. 17, I&GN Survey, Located 3 1/2 miles SE of White Deer. Plugged 2-7-47. Total Depth 3200'.
Hutchinson County—J. M. Huber Corporation, Midstate State No. 1, Sec. 17, Blk. 47, H&T Survey, Located 8 miles NE of Berger. Plugged 1-1-47. Total Depth 2745'.
Hutchinson County—Sinclair Prairie Oil Company, J. A. Whittenburg No. 1-B, Mary Whitley Survey, No. 1, G.H. & H Survey, 2640' from S and E lines Sec. 54, Blk. 2-B, 10 miles SE of Stratford. Phillips Petroleum Company, Etelle No. 1, G.H. & H Survey, 2640' from E and W lines Sec. 50, Blk. 1-C, 6 miles SE of Texoma.
Carson County—Perkins-Prothro Company, S. H. Burnett No. 8, Sec. 11, Blk. 5, I&GN Survey.

Cities Service's Weekly Oil Report

TEXAS
Cities Service Oil Company reported the completion of its Kariker No. C well in Hardin County, Texas, for an initial potential of 215 barrels of oil, no water, in 24 hours. Test was made through a 3-16 inch choke. Hardin County, Kariker No. 5, 1335 feet S, 350' feet E of NW Cor. Lease, Nancy Fuller arvy., completed for an initial potential of 215 barrels of oil; no water, 24 hours, through a 3-16 inch choke. Throckmorton County Matthews No. 1 (wildcat) C SW SW SW Sec. 29, Comanche Indian Reservation, drilling at 3133 feet. Wise County, Flowers No. 1, 2000 feet S, 457 feet W of NE Cor. of E. H. & W. Thompson arvy., drilling at 4761 feet.

OKLAHOMA
Cleveland County, Wingate No. 1 (partnership) 330 feet N, 350 feet W of E-4 Cor. C SE SE NE Sec. 14-7N-1E, no report. Cotton County, Copier No. 5, 350 feet S, 330 feet W of NE Cor. Sec. 18-35-11W, shut down. Garvin County, Rogers B No. 1 (wildcat, partnership) SW-NE SE Sec. 25-4N-4W, coring at 11860 feet. Rogers B No. 2, C NE NW SE Sec. 25-4N-4W, acidized with 1500 gallons. Hughes County, Nicks No. 1 (wildcat) C NE SE NW Sec. 12-8N-10E, Moving in. Hutchinson County, Harrison No. 1 (partnership) C SW SW Sec. 36-6N-4W, drilling at 8857 feet. Lo drill stem test. Top huntun, 8795 feet. Ramsey No. 1, C SW NE Sec. 22-8N-4W, drilling at 10015 feet.

Noble County, Stockton No. 1 (wildcat) C SW SE SE Sec. 18-23N-1W, drilling at 3185 feet. Oklahoma County, Whisler No. 1 (partnership) C SW SW Sec. 11-14N-4W, drilling at 6511 feet. Reno County, Burden B No. 1, C NE SE SW Sec. 23-8N-6E, Moving out rotary.

Base at Fort Worth Is Redesignated

FORT WORTH—(AP)—Fort Worth Air Field will be redesignated "Carswell Air Force Base" instead of "Griffis Air Base." The new name is in honor of the late Maj. Horace S. Carswell, Jr., of Fort Worth, a B-24 pilot killed in China who was awarded the Medal of Honor posthumously. The name "Griffis Air Force Base" given the field a few weeks ago, was transferred to the Rome Air Depot at Rome, N. Y., honoring Lt. Col. Townsend Griffis of Buffalo, N. Y., killed in a crash in England early in the war.

Get the Facts and You'll Get a Jeep

The Universal "Jeep" does more jobs, at less cost per job, than any other farm vehicle. It is more versatile, more comfortable, safer and easier to operate. Let us prove that—in a demonstration on your farm, using your equipment.

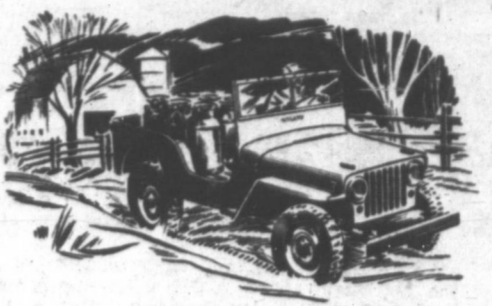

WINTER DRIVING. The "Jeep" has traction for getting through deep drifts or sudden thaws... it gets around over soft, muddy ground... breaks a path for other vehicles. With snow plow attached, it quickly clears driveways or barnyards.

TO MARKET AND BACK. The "Jeep" works the year around as tow truck or pick-up—hauling livestock or produce to market and bringing supplies back to the farm. Snow-clogged, ice-glazed or muddy roads are no problem.



FARM CHORES. Grinding feed is just one of the many winter chores made easier with the Universal "Jeep". Its power-take-off operates all kinds of belt-driven farm equipment.

SEE THE 4-WHEEL-DRIVE UNIVERSAL Jeep

McWILLIAMS MOTOR CO.
411 S. Cuyler Phone 1563

RADCLIFF SUPPLY CO.
OIL FIELD EQUIPMENT
PHONE 1200113 E. BROWN

MAGNETO REPAIRING
COMPLETE STOCK PARTS AND NEW MAGNETOS
SALES—SERVICE—PARTS
For Briggs & Stratton Kohler Light Engines Wisconsin Plants Engines ALL WORK GUARANTEED
RADCLIFF BROS. ELECTRIC CO.
519 S. Cuyler Phone 1220

FOR TOPS In good clean fun and entertainment see the Kiwanis sponsored—
TOP O' TEXAS REVUE
Monday and Tuesday Evening, Feb. 2nd and 3rd
Junior High School Auditorium

FOR TOPS In Fine, Economical Laundry Service
CALL 6-7-5
YOUR LAUNDRY AND DRY CLEANERS
309 E. Francis Pick-Up and Delivery Service

YOUR HOME OWNED and OPERATED UTILITY

TODAY'S BIGGEST DOLLAR VALUE... NATURAL GAS

Yes, today's biggest value is Natural Gas. This month's bill may be a little higher (for remember last month was a cold month). Yet Gas is still your biggest value—for you are still buying gas at the same cost as in 1940... 30c per thousand feet for the first 30 thousand feet.

NEARLY EVERYTHING HAS GONE UP AND UP... BUT NOT NATURAL GAS

By today's price standards you are getting your gas AT LESS THAN $\frac{1}{2}$ PRICE

TEXAS GAS & POWER CORP.
106 N. Russell Pampa, Texas Phone 2100
YOUR GAS COSTS YOU THE SAME TODAY AS IT DID IN 1931

DON'T WAIT SAVE on Furniture NOW

Dollar Day

SPECIALS!

100 percent Wool Blankets

\$8⁹⁸ and up

Panel BABY CRIB

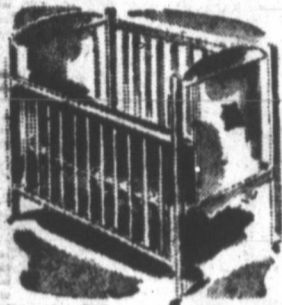

WHITE'S SPECIAL PRICE \$24⁵⁰

The kind that lets baby sleep safely and soundly, protected from drafts. Buy now!

Innerspring Baby Mattress

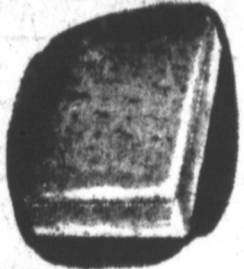

WHITE'S SPECIAL PRICE
Crib mattress, restful innerspring moisture resistant nursery covers.

Durham Metal Card Table

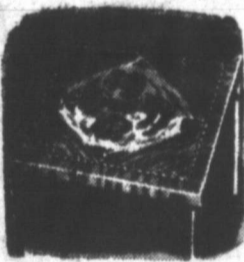

White's Special Price \$4.95

FEATURES YOU WANT
Stability of all steel frame. Convenience of quick folding and setting up. Protection of stockings by table's smooth legs.

Here's Something for the Home FIREPLACE



White's Special Price \$44⁵⁰

White enamel fireplace, portable type. So easy to install.

BUY ON EASY CREDIT TERMS

5-Piece Solid Oak MODERN DINETTE

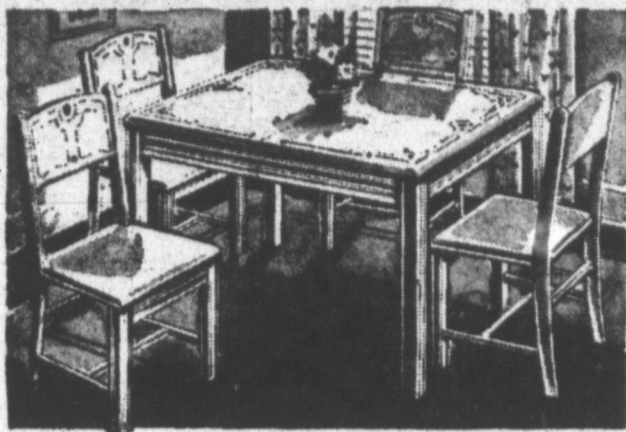

Regular Price \$49.95

White's Special Price \$39⁹⁵

A substantial solid oak dinette set distinguished by its fine modern styling. Extra large extension type table will seat six people. Finished in harvest tan to add a warm note to the color scheme of your kitchen or breakfast room.

YOU PAY ONLY \$1.25 WEEKLY

OCCASIONAL ROCKERS



White's Special Price

Comfortable rocker with springy seats, padded back, smart tapestry covers. \$14⁹⁵

Lace Panel

CURTAINS
White's Special Price \$2⁴⁹ each

Neatly hemmed sides and bottom
Top headed, ready to hang
Exquisite patterns in craftspun rayon and cotton with a lustrous finish. Deep eggshell color. You'll want to hang them at the important windows in your home!

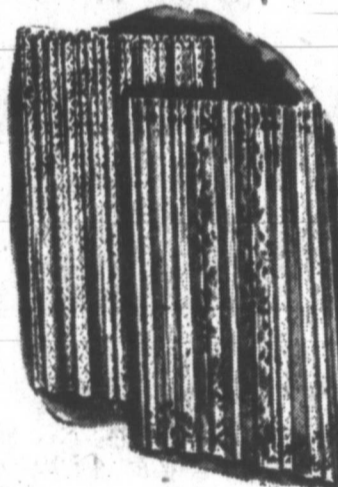

4-Piece Maple BEDROOM SUITE

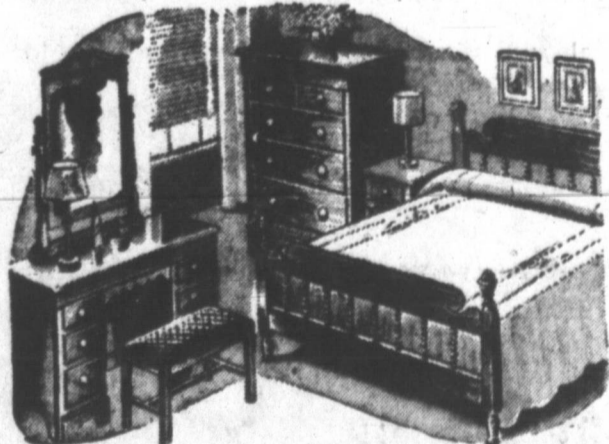

WHITE'S SPECIAL PRICE \$119⁵⁰

Early American bedrooms, too, have an old fashioned charm and comfort when furnished in mellow maple—and besides, it's easy on your budget! \$2.00 Per Week

SHOP AT WHITE'S AND SAVE

4-PIECE POSTER BEDROOM SUITE



White's Special Price \$129⁵⁰

Impossible you say to furnish a bedroom comfortably and attractively on so little! Then come in and see this fine suite. Bed, chest, vanity with plate mirror and bench walnut finished. All four pieces! \$2.50 PER WEEK

It Is Often Said You Get More For Your Furniture Dollar Than Any Other Spent

KROEHLER 2-PIECE SOFA BED



White's Special Price

\$159⁵⁰

Spacious modern design two-piece sofa bed suite. Ideal for small homes or for an "extra room." Luxurious day or night comfort achieved with wonderful new KROEHLER "Cushionized" construction. Large storage compartment. Colorful modern fabrics.

\$2.70 PER WEEK

COTTON THROW RUGS

Shag . . . Loop

2x3 \$3.95
3x5 \$7.45

CHENILLE BATH SETS

\$3⁴⁹ & \$4⁹⁸

\$1⁰⁰ Off Monday

SHOWER CURTAINS

\$2⁹⁵

WASHABLE CLOPAY SHADES

White or Ivory

36" width Each 69^c

18th Century Bedroom Suite

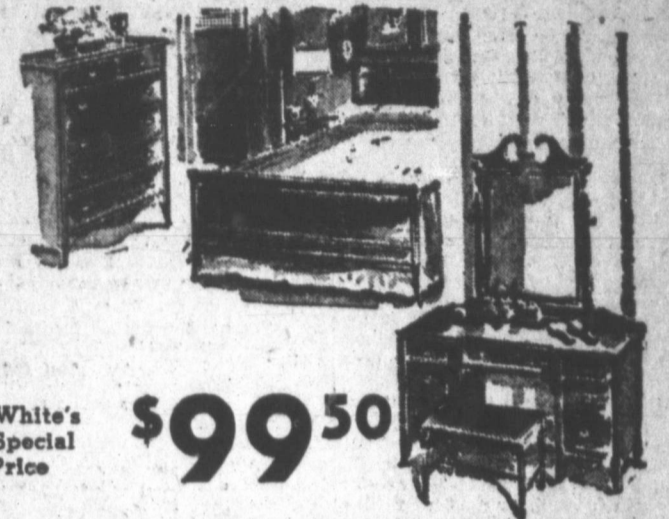

White's Special Price \$99⁵⁰

One of our finer 18th Century bedroom suites in select mahogany veneers. Bed, chest and vanity, priced at a wonderful saving. Act promptly!

\$1.75 WEEKLY

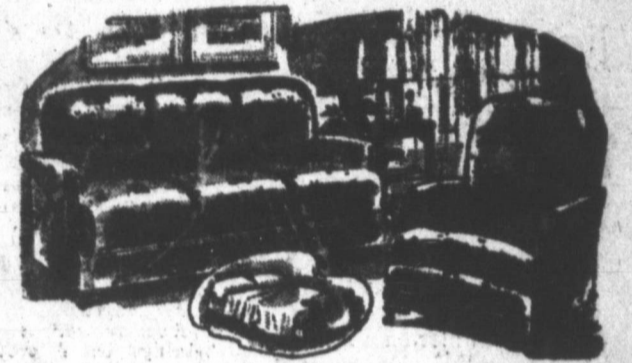

2-PIECE STUDIO SUITE

White's Special Sale

\$99⁵⁰

Just like a regular attractive suite, but the sofa opens to provide comfortable sleeping space for two! Full innerspring construction. Comfortable platform rocker. Helps to solve the housing shortage problem!

Only \$1.75 Weekly

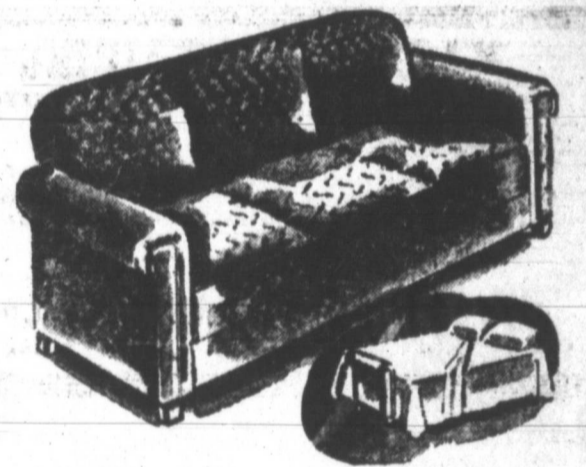

SOFA BED

You'll be all set for overnight guests with this handsome sofa that makes up into a double bed. Assorted covers!

\$1.50 Per Week

WHITE'S SPECIAL PRICE

\$79⁵⁰

3-Piece Solid Maple Suite



WHITE'S SPECIAL PRICE

\$159⁵⁰

Solid maple frame with reversible cushions covered in attractive tapestry. Hurry for this fine value!

You Pay \$2.50 Per Week

EASY TERMS! LOWEST PRICES EVER

WHITE'S
Auto Stores
THE HOME OF GREATER VALUES
FURNITURE ANNEX

Blood Banks Ready To Help in Disasters

By MARTHA COLE
Associated Press Staff

Let disaster come—two ships explode at Texas City, a tornado tear through the Panhandle or a schoolhouse crumble in New London—and the doctors' cries for plasma and blood rise simultaneously with the moans of the wounded.

That's why blood bank experts met in Dallas last fall to exchange their experiences and organize for cooperation in time of emergencies.

"Every city should consider itself a potential disaster area," said Dr. William Levin, director of the

blood and plasma bank of John Sealy Hospital, Galveston.

"We felt the jolt of the first Texas City explosion last April at the hospital across the bay," Dr. Levin said. "We didn't know what to expect but within 15 minutes we had a car filled with plasma on its way to Texas City."

"Within an hour the wounded were pouring into John Sealy by ambulance, trucks and cars. We even heard they were sending them across the bay by boat."

"Within the first four hours we administered 1,888 units of plasma but had no calls for whole blood. After that we had almost no calls for plasma but hundreds daily for a week for whole blood."

"From this experience," he told blood experts, "it seems advisable to have adequate plasma on hand to meet any emergency."

Plasma has the advantage of keeping indefinitely because it is processed and dried blood. Whole blood must be administered within 15 to 21 days after it has been taken from a donor.

In the Texas City disaster, the Buchanan Blood Bank in Dallas acted as the procurement agency for whole blood and flew it by Navy plane to John Sealy. The blood bank in Galveston had only

to work with distributing it. In the first week following the explosion 782 pints of whole blood and 1,956 units of plasma were administered.

Dr. C. M. Bistein of Oklahoma City rushed to Woodward, Okla., and the Texas Panhandle last April when a tornado tore through the country to find blood from a Wichita, Kans., bank already there.

"I don't know who ordered it or how it got there," he said, "but we sure could use it. Our only trouble was lack of small needles for babies."

"You've got to be prepared for everything."

Blood bank centers in Florida have worked out detailed plans with doctors and hospitals for cooperation during hurricane emergencies.

"Fortunately we know how to take care of ourselves during hurricanes and have very few wounded," said Dr. John Elliott of Miami.

Dr. Leon C. Mermod, director of the blood bank of Hawaii, said that the bank began its task of taking 500 to 600 pints of blood daily while the bombs were still falling on Pearl Harbor Dec. 7, 1941.

"We learned to meet an emergency the hard way," he said.

MORE FITTINGS FOR BEST HEARING!

New All-in-One Sonotone gives closer fitting to personal needs. See it!

Robert R. Gray
Sonotone Hearing Service
1320 Garland St.
Pampa—Phone 625

50 POUNDS LOST WITH BARCENTRATE

Many people have reported amazing results with this home recipe. It's easy—no trouble at all and costs little. Just go to your drugist and ask for four ounces of liquid Barcentrate. Pour this into a pint bottle and add enough grapefruit juice to fill bottle. Then take just two tablespoonfuls twice a day. That's all there is to it.

If the very first bottle doesn't show the simple, easy way to lose bulky fat and help regain slender, more graceful curves; if rotund pounds and inches of excess fat don't seem to disappear almost like

magic from neck, chin, arms, bust, abdomen, hips, calves and ankles, just return the empty bottle for your money back.

Here is what Mrs. C. M. Earab, 303 N. 21st St., McAllen, Texas, says about Barcentrate: "I want to tell you that I have lost 50 pounds since taking Barcentrate. I still want to lose 20 more pounds as I now weigh 167, a reduction from 217 pounds."

To lose weight the grapefruit juice way, Barcentrate from your favorite drugist today.

Peace Promoted in High Schools

MOUNT AIRY, N. C.—(AP)—A growing movement to get high school boys and girls to talk and think about peace and a world government has entered its second year.

The movement was originated and is financially backed by Oscar K. Merritt, Mount Airy furniture manufacturer. It functions through the University of North Carolina extension division.

Last year more than 200 high schools in the state took part. Some 1,000 students made talks to at least 100,000 hearers.

This year's program will discuss, "How Can the United Nations Be Strengthened?"

Pop Corn This New Easy Way



It's real fun to pop corn this quick, easy way! No more shak-ing or stirring. You just put it on the stove and listen to it pop!

Here's how:
Get a deep kettle or sauce pan of heavy aluminum or cast iron. Use one with a well-fitting lid. A pressure cooker, without the weight and gasket, is perfect. Cover the bottom with a liberal portion of cooking oil and heat until hot. Drop in two or three kernels. When they pop you know the temperature is just about right. Then thoroughly cover the bottom of the kettle with one layer of pop corn. Now put on the lid and wait. But you won't have to wait long. Quickly you'll hear the kernels going pop-pety-on. When the popping ends, quickly remove from heat, and empty at once! That's all there is to it.

You'll be amazed at how quickly you can pop up a lot of pop corn this new way. No trouble at all. It's actually fun to show your friends how to do it. Be sure to use good pop corn—the kind that comes packed air-tight in metal cans. Pop corn that is not sealed air-tight and moisture-proof quickly loses its popping ability.

Airline Planned For Mecca Pilgrims

LONDON—(AP)—Pakistan pilgrims to Mecca, whose journeys have taken fifteen days, soon will be able to reach the shrine in one day by air.

Two Pakistan industrialists, Hussain Malik and Mahmoud Haroon, are forming a new airline, to be a subsidiary of the Islamic Airways and known as "Pakair."

In London to buy new planes, the industrialists said the company already has twelve aircraft, including two four-engine Liberators. It requires six more planes for the service to the Middle East.

Improving the highways simply means going from ruts to tax.

HOT SOUP . . .
College Inn Individual Soups and Chilies

Served hot at your favorite cafe, restaurant, confectionary, soda fountain or drive inn.

Join the soup line and try a bowl of this soup or chili today.

Distributed by
Kennedy Distribution Co., Pampa

Compare WITH ALL-IN-ONE AIDS AT TWICE THE PRICE!

SUPER-FONIC ALL YOU WEAR

\$79.50

2 1/2" x 2 1/2" — 6.0z. — 3 tubes

HEARING AID

WORLD'S SMALLEST 30 VOLT ONE-UNIT
Guaranteed for one year

Tremendous volume, national sales make this sensationally new low price possible. All the features of hearing aids costing as much as \$200! You'll be amazed at the clearness and reserve power of your Superfonic. The transmitter and miniature batteries are all in one unit. Efficient noise cut-out. Tubes and receivers individually fitted to your personal needs.

FREE DEMONSTRATION.
BATTERIES FOR ALL MAKES OF HEARING AIDS

"Your Community Hearing Aid Center"
BERRY'S PHARMACY
100 S. Cuyler Phone 1110

On The Radio

SUNDAY ON NETWORKS

NBC—2:30 One Man's Family; 4:30 Sunday Theater "Green Pastures"; 5:30 Hollywood Preview; 6:30 Jack Benny; 7:30 Charlie McCarthy; 7:30 Fred Allen; 8:30 Familiar Music Album; 9:30 Rise Stevens Time; 9:30 Gene Autry Show; 10:30 Sam Spade Detectives; 11:30 Corliss Archer; 11:30 Escape New Time; 11:30 Strike It Rich Quiz.

ABC—1:30 Mr. President, new time; 2:30 Sunday Serenade, new time; 3:30 Andrews Sisters in Soundoff; 4:30 Counter Spy; 6:30 Child's World; 6:30 Exploring Unknown; 8:30 Raymond Massey in "Missouri Legend"; 9:30 MBS—12:30 Alan Lomax Ballads; 1:30 Juvenile Jury; Cherry Ward of England; 4:30 Quick as a Flash; 6:30 New Format for Gabriel Heatter program; 7:30 Meditation Board; 8:30 Meet Me at Park's; 8:30 Jim Backus Comedy; 9:30 Serenade.

Gentle Art Used As Boy Meets Girl

PRAGUE—(AP)—Walking through a park in a Prague suburb, a 20-year-old girl was assaulted recently by a youth who hit her on the head with an empty bottle. The assailant fled when the girl started to scream, but was caught by passerby. In a statement to the police the youth claimed he attacked the girl "because I wanted to get acquainted with her."

TOP O' TEXAS NSA
The Top O' Texas Chapter of NSA will have a dinner at the Court House Cafe at 6 p. m. on Friday, Feb. 6.

Food Shortage Cancels Dinners

PRAGUE—(AP)—Because of the food shortage, no big state banquets or official dinners will be held at President Benes' residence this year.

Japanese Union Purge

TOKYO—(AP)—The central committee of Japan's Federation of Trade Unions, representing more than 1,000,000 workers, has unanimously adopted a resolution to clear Communists from the ranks of Japanese labor.

C. M. Tucker Asking For Constable Post

Carl M. Tucker, a resident of Gray County for 15 years, today authorized The News to announce his candidacy for the office of Constable, Precinct 2, subject to the Democratic primaries.

Mr. Tucker, who has served for two years as a Gray County deputy sheriff, said:

"Should the voters of Precinct 2 see fit to elect me to this office I will devote my full time to executing the duties of the office and will not permit outside interests to interfere with my work. I feel I am qualified to fill the post with my past experience of serving Court papers both civil and criminal.

"I solicit the vote and influence of the people of Precinct 2 at the July Democratic primaries."

(Political Advertisement)

SAVE 1/4TH-1/3RD-1/2 AND MORE

ANNUAL Clearance

OF WORLD-FAMOUS
Dupler's Furs

The Once-a-Year Event that brings OUTSTANDING VALUES

A Dupler Fur Expert will be in our store Monday and Tuesday, Feb. 2nd & 3rd

Despite rising prices—despite high replacement costs—Dupler's Furs carry on with the tradition of their Annual Clearance Sale to bring you Greatest Savings of the year.

Guaranteed quality furs . . . all advance 1948 styles . . . at savings that only Dupler's can and do offer . . .

TAKE YOUR CHOICE OF GORGEOUS... BEAUTIFUL FINE FURS...

\$128 to \$1,388

Some Prices as in all Dupler's Stores

10 Months to Pay
No interest or carrying charges

Murfee's
Pampa's Quality Department Store

* SMALL DEPOSIT RESERVES YOUR SELECTION *

Murfee's
Pampa's Quality Department Store

The quiet distinction of good taste exemplified by Rothmoor's perfect hand-tailoring, in Stroock's plaid woven exclusively for Rothmoor.

As seen in Harper's Bazaar

ROTHMOOR*

HATS OFF TO

MR. W. B. WEATHERED, genial Postmaster in Pampa since 1944. "Red," as he is known to everyone, has been and still is a "wheelhorse" in all activities for the improvement of Pampa and the Top of Texas. Prior to his appointment as Postmaster, he was County Superintendent for nine years. He is a member of the First Methodist Church, on the Board of Directors of the Top of Texas Rodeo Assn., a Past President of the Kiwanis Club, Past President of the Adobe Walls Council BSA, having served in this position for three consecutive years, and a Past President of the Chamber of Commerce.



Although he has served almost every worthwhile organization in its highest office, he has not let up in his interest and support of them. He is still actively boosting every local group and hometown enterprise that contributes to the building of a bigger and better Pampa.

Mr. Weathered is another of our satisfied customers. He is as this to say about the renovating work we did on his hat recently:

"I'm glad to find that Pampa now has a place which does good hat renovating work. LANGSTON BROS. HATTERS roved to me that they can do the job as well as out-of-town concerns, with the advantage of being able to get the hat back to customers in a matter of days instead of our having to wait weeks or months as has been the case heretofore."

PEOPLE YOU KNOW are finding our hat renovating service to be satisfactory in every respect. We believe that you too will like it. Bring us your hats today. Satisfaction guaranteed.

LANGSTON BROS. HATTERS

"Top Hatters for the Top of Texas" 117 S. Ballard Phone 2183

Big Stratosphere Chamber Slated for Introduction

LONDON — The wraps are off the complete structure, built about to be pulled off the world's largest and most modern stratosphere chamber. It will be able to test flying conditions for planes in the era now unfolding of supersonic flight far above the weather.

This chamber, now almost finished at Vickers Armstrong Ltd., consists of an all-steel cylinder 50 feet long and 25 feet in diameter. It will be able to reproduce temperature and pressure conditions up to an altitude of 70,000 feet.

The complete structure, built and welded throughout with half-inch-thick plate, weighs 215 tons. It is reinforced with external rings six inches deep and three-quarters-of-an-inch thick.

A powerful refrigeration plant can reduce the temperature inside the test chamber to 70 degrees Centigrade below freezing (minus 54 degrees Fahrenheit) and even lower. Special fans installed within the chamber can raise the temperature to at least 70 degrees Centigrade (158 degrees Fahrenheit).

The vast range covered by this test chamber can be gauged from the fact that the lowest temperature ever naturally recorded in the world was minus 96 degrees Centigrade (approximately -7 degrees Fahrenheit) registered at Verkhoyansk, Siberia, in February 1892.

Highest world temperature on record is 58 degrees Centigrade (approximately 136 degrees Fahrenheit) registered at Axixia in Libya in September, 1922.

Vacuum pumps driven by a 140 h. p. motor can reduce pressure in the stratosphere chamber to one-twentieth of an atmosphere in exactly 90 minutes.

Britain's top aviation experts will make use of these artificial conditions for exhaustive tests on cabin pressurizing and heating under all kinds of world conditions. Technicians will also be able to study the behavior of aircraft structure, controls and engines under extreme and rapidly changing climates.

The new chamber, now being made ready for operation at a factory in Waybridge, Surrey, opens up a highly advanced testing field of aviation research never before possible.

Its circular steel walls bristle with complicated mechanisms inside for creating a vast range of flying conditions. One of these is an ingenious "dryer" that absorbs moisture from air entering the chamber. It prevents icing when the chamber is operating at sub-zero temperatures. The 40,000 cubic ft. chamber will be powered by its own electric sub-station capable of supplying up to 1,750 h. p.

When completed, a unique "tea cosy" structure will protect the chamber, its walls and roof covered with 12 inches of insulating material. The unit's concrete floor will be raised on brick piers eight feet above concrete foundations to avoid frost-heave under the building. Free air will be able to circulate through this 'cellar.'

Two airlock compartments afford access to the chamber. Whole airframes can be inserted into the chamber through the door end, which contains hot or cold ducts for spraying hot or cold air. The massive assembly door is built to slide aside on a wheeled cradle. The end plate is sealed by sponge rubber and is closed securely by a 40-ton hydraulic jack.

Britain's aircraft designers of the future will be able to study their newest models undergoing rigorous tests through glass observation panels in the top and bottom walls of this world's biggest stratosphere chamber.

Get Welcome Relief From Stomach Gas, Sour Food Taste

Do you feel bloated and miserable after every meal? If so, here is how you may rid yourself of this nervous distress. Thousands have found it the way to be well, cheerful and happy again.

Everlasting food in the stomach, a vital gastric juice must flow normally to break-up certain food particles; else the food may ferment, sour food, acid indigestion and gas frequently cause a morbid, lousy, fretful, peevish, nervous condition, loss of appetite, underweight, restless sleep, weakness.

To get real relief you must increase the flow of this vital gastric juice. Medical authorities, in independent laboratory tests on human stomachs, have by positive proof shown that SSS Tonic is amazingly effective in increasing this flow when it is too little or scanty due to a non-organic stomach disturbance. This is due to the SSS Tonic formula which contains special and potent activating ingredients.

Also, SSS Tonic helps build-up non-organic, weak, watery blood in nutritional anemia—so with a good flow of this gastric digestive juice, plus rich red blood you should eat better, sleep better, feel better, work better, play better.

Avoid punishing yourself with over-doses of soda and other alkalis to counteract gas and bloating when what you so dearly need is SSS Tonic to help you digest food for body strength and repair. Don't wait. Join the host of happy people SSS Tonic has helped. Millions of bottles sold. Get a bottle of SSS Tonic from your drug store today. SSS Tonic helps build sturdy health.

England's Crown Jewels Go Back in the Tower
LONDON — (AP) — The fabulous crown jewels of England, said to have an intrinsic value of \$25,000,000, have been taken from their secret wartime hiding place and are again on display in the Tower of London.

The last great state occasion in which the jewels were used was the coronation of the present King George VI.

The fabled collection includes the king's royal sceptre, which carries in its head the Star of Africa, a diamond weighing 516 1/4 carats; the jeweled sword of state, which weighs approximately \$80,000; and the imperial state crown, which weighs slightly more than 39 ounces and contains 2,783 diamonds, 277 pearls, 16 sapphires, 11 emeralds and five rubies.

NO USERS
Walter Hunt, in 1834, invented a sewing machine with shuttle and eye-pointed needle, the basic elements of later machines, but no one would use it.

Home, sweet home is any old place where mother wishes to goodness the kids would hang up their things.

Press Friend Dies Before the Mahatma
NEW DELHI — (AP) — The last person to whom Mohandas K. Gandhi spoke before he entered the Poona Jail in 1932 was James A. Mills, widely traveled Associated Press reporter. The first to greet him when he was freed 17 months later was Mills.

"Why, Mr. Mills," Gandhi exclaimed, "if I should die and start to enter Heaven, I should expect to see you waiting to interview me at the gates!"

Mills died in 1942. Gandhi paid him a special tribute.

Dr. Malcolm H. Wyatt
Is Now Associated With
Dr. M. C. Overton, Jr.
And
Dr. Edw. S. Williams
Offices At
303 Combs-Worley Bldg.

GOSPEL MEETING

CHURCH OF CHRIST

400 N. Wells
NOW IN PROGRESS

Services each evening at 7:30
continuing
through Sunday, Feb. 8

WE WELCOME YOU

B. A. Ricketta, Song Director

Alva Johnson, Minister

february dollar day....

final clearance of winter mdse...

Spring merchandise is pouring in and we must make room for it... so we are clearing out all remaining winter merchandise, even though it looks as if we should just be getting it in as cold as it is... of course, you realize that our size range, as in all clearances, is not complete... so come early.

maternity dresses two special groups of maternity dresses in crepes and gabes... sizes 9 to 18 and in a wide variety of styles and colors... values up to \$16.95. \$4 and \$7		dresses remaining fall and winter dresses are in these two groups of dresses... sizes 9 to 20 and in a variety of materials and colors... values to \$32.95. \$5 and \$8																			
kayser gloves our entire stock of kayser fabrics and wool gloves in this group... values up to \$2.00. \$1		kayser dark nylons a new shipment of kayser dark nylons in 45/30... in regular and long lengths. \$1.50																			
kayser gowns a special purchase of kayser gowns... formerly sold for \$3.95... sizes 32 to 40... tearose, black and blue. \$3		formals our remaining stock of formals and dinner dresses are being closed out at this ridiculous price... values up to \$45.00... so get ready for a good time now. \$11																			
sweaters we bought too many sweaters so now our loss is your gain... values to \$9.95, now only \$2.00. \$2		slips a special group of crepe and satin slips... both tailored and lace trim... values up to \$10.50... sizes 32 to 40. 1/2 price																			
bags closing out our entire stock of bags... kids, plastic and cloth... values to \$16.95. \$1 and \$3		kayser anklets entire stock of anklets, values to fifty cents, now three for one dollar... a virtual rainbow of colors. 3 for \$1																			
coats and suits <table border="1"> <tr><th>Was</th><th>Now</th></tr> <tr><td>1 Tweed Coat—Size 12</td><td>39.95</td></tr> <tr><td>1 Wine Coat—Size 15</td><td>99.00</td></tr> <tr><td>1 Black Coat—Size 9</td><td>89.95</td></tr> <tr><td>1 Black Coat—Size 17</td><td>89.95</td></tr> <tr><td>1 rGay Fur Trim—Size 15</td><td>129.00</td></tr> <tr><td>1 Gray Suit—Size 18</td><td>55.00</td></tr> <tr><td>1 Brown Suit—Size 18</td><td>45.00</td></tr> <tr><td>1 Black Suit—Size 12</td><td>55.00</td></tr> </table>		Was	Now	1 Tweed Coat—Size 12	39.95	1 Wine Coat—Size 15	99.00	1 Black Coat—Size 9	89.95	1 Black Coat—Size 17	89.95	1 rGay Fur Trim—Size 15	129.00	1 Gray Suit—Size 18	55.00	1 Brown Suit—Size 18	45.00	1 Black Suit—Size 12	55.00	charma bras entire stock of charma bras... values to \$5... now two for \$3... sizes 32 to 38 in a, b, and c cups... a nationally advertised bra but we are discontinuing the line. 2 for \$3	
Was	Now																				
1 Tweed Coat—Size 12	39.95																				
1 Wine Coat—Size 15	99.00																				
1 Black Coat—Size 9	89.95																				
1 Black Coat—Size 17	89.95																				
1 rGay Fur Trim—Size 15	129.00																				
1 Gray Suit—Size 18	55.00																				
1 Brown Suit—Size 18	45.00																				
1 Black Suit—Size 12	55.00																				

BOLES DOLLAR DAY SPECIALS

Boys' "Tuf Nut" BLUE JEANS A new shipment of those better fitting "tuff nut" blue jeans— Sizes 0 to 7 \$1.98 Sizes 8 to 11 \$2.29 Sizes 12 to 18 \$2.49	Cotton Print 36-inch fast color cotton prints in a beautiful selection of prints and plaids—regular at 59c yard— 2 yards for \$1.00	Sheets & Pillow Cases 81x108 sheets, excellent quality— 10 dozen to sell for \$229 each Pillow Cases 39c each	
Clopay Window Shades Without rollers— 6c each	Novelty Blankets 54x72 Novelty Indian design blanket, excellent as throw robes— \$21c	Heavyweight Outing 36-inch heavy-weight outings— 29c yard	Jacquard Bedspreads Excellent assortment of patterns in 84x105 cotton bedspreads— Regular \$3.00 at \$4.98
Men's Woolen Shirts Your choice of our complete stock of men's and young men's woolen shirts— Values to \$9.95 \$3.00	Men's Blue Khaki Suits Men's sanforized blue khaki pants, size 36 to 42. Shirts size 16 1/2 & 17 Complete suit \$3.00	Boys' Corduroy Pants Boys' pinwale corduroy pants, size 6 to 16— Blue or brown \$1.98	
MEN'S Flt Hats Your choice of our entire stock of men's felt hats— Values to \$10.00 \$5.00	MEN'S "Tee" Shirts Men's white "tee" shirts, regular at 98c, special group— 2 for \$1.00	BOY'S LEATHER Jackets 6 only — boy's aviator style zipper front leather jackets— Sizes 8 to 12 \$5.00	Ladies' Shoes Your choice of our remaining stock of ladies' sport and dress shoes— Not all sizes \$1.50 pair

REMEMBER YOU CAN ALWAYS DO BETTER AT BOLES DRY GOODS CO.

216 N. Cuyler Phone 1024



attend the kwanis-sponsored
top o' texas revue
feb. 2-3-8:15

New Versatility Is Believed Found in Music Instrument

AUSTIN — A musical instrument more versatile in range and tone than any in existence may come out of a University of Texas research laboratory in the not-too-distant future.

Although it is now in its earliest stages, Physicist R. B. Watson who is working on the instrument, says he hopes it may

Do 'Plate-Sores' Bother You?

If your "GUMS" itch, burn, or cause you discomfort, druggists will return money if the first bottle of "LETO'S" fails to satisfy.

the instrument would baffle the craftsman of old who depended on his ear and ingenuity in producing an instrument.

Dr. Watson utilizes a television camera and electrical circuits to produce his tones. By electrical and optical controls, he can set up the tone which he wants to produce; then he can change the pitch without changing the overtone structure. In other words, there was a lot of guess work in the old-time method of inventing a musical instrument, in addition to the genius of the inventor, but—aided by television and electronics—Dr. Watson has his tones well under control and knows what he is doing.

Currently Dr. Watson's instrument is in no condition for anyone to play it. He refers to it now as a "tone generator" rather than an instrument. Just one tone at a time is being investigated, and many more hours of research will be required before the project is in final form.

The ultimate test of his instrument, as of any instrument, says Dr. Watson, will be whether or not it is satisfying to the ear. He isn't worrying yet about how it will be played.

Denmark Cuts Down On Its Police Cost

COPENHAGEN (AP)—In 10 years the cost of maintaining Denmark's police has risen 500 percent to \$21,000,000, but now is being cut down.

A police spokesman said that in 1938-39 everything was so lively in small Denmark, that there hardly was a policeman—"but things are different now."

The costs, however, are being reduced. Two years ago the Danish police had 1,000 cars at its disposal—now the number is 500, and in addition 2,000 assistant policemen are being dismissed.

New Glamor Deb



The title of "Glamor Deb of the Year," vacant since the deb days of Brenda Frazier, goes to Virginia Leigh, above, of New York. She made her bow to the society at the annual Debutante Cotillion.

Negroes to Take Graduate Classes At the University

AUSTIN (AP)—Graduate instruction for Negroes will be provided in Austin under a contract signed by the University of Texas Board of Regents Saturday until graduate courses can be set up at the Texas State University for Negroes at Houston.

The contract, sought here earlier in the week by a committee of the Negro university's board of directors, calls for the graduate instruction to be offered on the same basis as law instruction is presently provided in Austin for Negroes.

The temporary law school for Negroes is taught by University of Texas faculty members in a building of the university campus. The same classrooms would be used for the graduate instruction.

The contract between the two schools follows application of W. Estor Kirk of Marshall, associate professor of political science at Tillotson College for Negroes here, for admission to the University of Texas. The graduate course he sought was not offered at the Houston institution.

Present plans call for the moving of the law school and the proposed graduate courses to Houston after Aug. 31.

Other recent action included approval of a contractual agreement with Texas A. and M. College and the State Railroad Commission for a joint petroleum research project which would give particular emphasis to petroleum products of secondary

importance.

The contract between the two schools follows application of W. Estor Kirk of Marshall, associate professor of political science at Tillotson College for Negroes here, for admission to the University of Texas. The graduate course he sought was not offered at the Houston institution.

Present plans call for the moving of the law school and the proposed graduate courses to Houston after Aug. 31.

Other recent action included approval of a contractual agreement with Texas A. and M. College and the State Railroad Commission for a joint petroleum research project which would give particular emphasis to petroleum products of secondary

importance.

The contract between the two schools follows application of W. Estor Kirk of Marshall, associate professor of political science at Tillotson College for Negroes here, for admission to the University of Texas. The graduate course he sought was not offered at the Houston institution.

Present plans call for the moving of the law school and the proposed graduate courses to Houston after Aug. 31.

Other recent action included approval of a contractual agreement with Texas A. and M. College and the State Railroad Commission for a joint petroleum research project which would give particular emphasis to petroleum products of secondary

importance.

The contract between the two schools follows application of W. Estor Kirk of Marshall, associate professor of political science at Tillotson College for Negroes here, for admission to the University of Texas. The graduate course he sought was not offered at the Houston institution.

Present plans call for the moving of the law school and the proposed graduate courses to Houston after Aug. 31.

Other recent action included approval of a contractual agreement with Texas A. and M. College and the State Railroad Commission for a joint petroleum research project which would give particular emphasis to petroleum products of secondary

importance.

The contract between the two schools follows application of W. Estor Kirk of Marshall, associate professor of political science at Tillotson College for Negroes here, for admission to the University of Texas. The graduate course he sought was not offered at the Houston institution.

Present plans call for the moving of the law school and the proposed graduate courses to Houston after Aug. 31.

Other recent action included approval of a contractual agreement with Texas A. and M. College and the State Railroad Commission for a joint petroleum research project which would give particular emphasis to petroleum products of secondary

recovery of oil and improvement of primary recovery methods.

The agreement, already approved by A. and M. and the Railroad Commission, takes cognizance that the university and college, sharing in the university endowment, are greater beneficiaries of oil production than any of the state's other institutions.

The long-term project calls for an estimated \$50,000 from each school for the period from now until Aug. 31, 1949.

The project is to be developed by a five-member committee composed of the chairman of the Petroleum Engineers Department of each institution, one other member from the staff of each Petroleum Engineering Department nominated by the chairman of the department and approved by the presidents of the two institutions, and one member of the Railroad Commission.

Russians Building New Asian Railway

MOSCOW (AP)—Grading and embankment have been completed for a new central Asian cross-desert railway.

Seventy thousand volunteer collective farmers laid the roadbed for 25 miles from the Aral Sea in the month, says the railway newspaper Whistle. A special track-laying machine is putting down the rails.

NOTICE...

BILL PEARSON

Auto mechanic, is now back in business here in Pampa... All type of general motor repair work... Free estimates gladly given.

Now located at
LEWIS & COMER GULF STATION
824 Alcock Phone 351

You'll Miss a Real Treat If You Miss Ken Bennett's Fifth Annual TOP O' TEXAS REVUE

Sponsored by
THE PAMPA KIWANIS CLUB

- Four Delightful Scenes!
- A Cast of Over 100!
- Eighteen of Pampa's Prettiest Models!
- Plenty of Fun, Good Music and Dancing!

Reserved and General Admission Tickets on Sale at Cretney Drug and Combs-Worley Lobby.

Admission: Adults \$1.00 - Students 50c - Reserved Seats 25c

Net Proceeds from this Show go to Support the

Kiwanis Club Youth-Activities Program

GET YOUR TICKETS NOW!

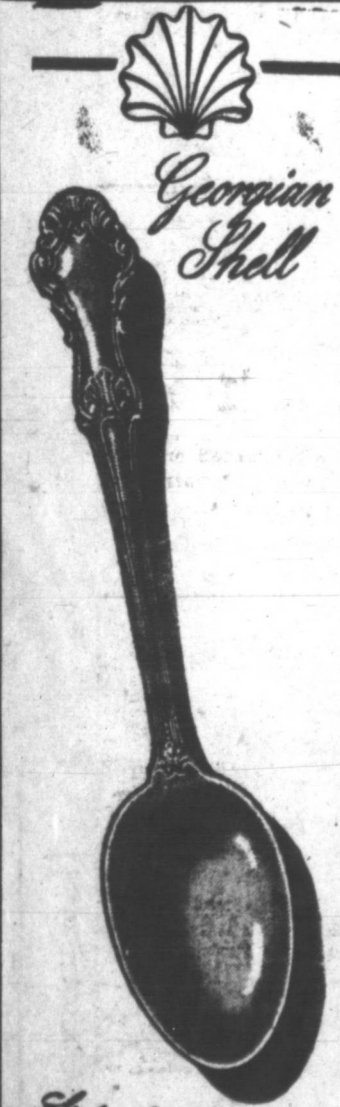

Designed by
FRANK M. WHITING
and Company

Collecting in the richness and distinction of design design, the very essence of cultural elegance. For your present standard

SILVER NEWS!

Frank M. Whiting, silversmiths since 1840, have joined the other distinguished names in McCarley's silver department.

The addition of Whiting Sterling patterns, two of which are illustrated, means that you now have six of the nation's leading smiths from which to choose your own pattern.

COME IN NOW AND SEE PATTERNS BY:

- Reed and Barton
- Gorham
- Towle
- Lunt

International Whiting

McCarley's

Your House of Fine Diamonds, Watches and Silverware



Designed by
FRANK M. WHITING
and Company

This design of Frank M. Whiting generally is destined for women and a glance at the Dutch inspired modern design will tell you why!

MONARCH
Special

FLOOR COVERING

See These Wonderful Bargains NOW ON DISPLAY!

ASPHALT TILE

Flexible-Reinforced

Asphalt Tile is wear-resisting, texture and colors permanent and requires no periodic refinishing. It is flexible, non-absorbent, sanitary and fire resistant. Asphalt Tile is a multi-purpose flooring combining rich beauty and long-term economy. Ideal for every room.

HANDY 9x9 INCH SQUARES FOR EASY INSTALLATION FULLY 1/4 INCH THICK

35c
Installed

PHONE TODAY FOR FREE ESTIMATES

LINOLEUM Bargains!

PRINTED LINOLEUM RUGS

- Heavy, tough enamels, baked on to a felt base forming a hard finish for long wearing surface. Rich fade-resistant colors, harmonizing well with other room furnishings.
- Heavy Weight 9x12 Feet \$9.95 each

ENAMEL PRINT YARD GOODS

Tough enamel surface resists spots and stains, bringing new beauty to your home, lasting protection at really low cost.

6 FT. WIDE
Sq. yd. 90c

INLAID LINOLEUM

LARGE ASSORTMENT OF PATTERNS, INCLUDING LIGHT SHADES

Standard Gauge Lineal Foot 1.83
Heavy Gauge Lineal Foot 2.33

Rubber Tile	Fill In	Sheet Rubber
Floor Covering	Floor Runners	Floor Covering
1/2-Inch Thick	24" and 36"	1-8 Inch Thick
All Popular Colors in Stock		Assortment of Marbled Patterns
Sq. ft. Installed 65c	Sq. yd. 49c to 69c	

Linowall and Service Wall

WALL COVERINGS

Scored or Plain Patterns

Without value on hand-made Master Craft—

HOOKED RUGS

30" x 66" \$12.50

COOK'S QUALITY PAINTS

COROC Wall Finish	RAPIDRY Enamel	VELVAY Semi-Gloss
\$3.49 GAL	\$1.75 qt.	\$1.36 QT.

Now Available in **NEWEST COLORS**

Most experienced and efficient floor covering mechanics in the Panhandle. All work guaranteed.

MONARCH HARDWARE CO.

113 W. Kingmill W. E. (Bill) Ballard, Mgr. Phones 200 - 201

Eyewitness Told Of Gandhi Death

LONDON —(AP)—Robert Stimson, BBC correspondent, witnessed the assassination of Mohandas Gandhi.

He cabled these impressions: "The shots did not sound very loud—they reminded me of firecrackers. Then when they were fired, Gandhi fell back."

"Immediately after this I saw some of Gandhi's entourage grasp-

pling with a heavy set man in a khaki bush coat. He had blood on him, no doubt from wounds inflicted by his assassins."

"Gandhi was picked up by some of his followers and carried into a house where he was taken to a back room," Stimson said.

Suddenly realization of what had happened swept through the crowd and a terrific cry of grief arose.

"The crowd of four or five hundred people waited with a grief most moving to see," Stimson said.

Men and women wept and beat their breasts."

Gandhi had arrived a few minutes late for his prayer meeting. But when he walked across the lawn from Birla House, Stimson said, "he was looking healthier and sprightlier than he had since his recent fast."

"He was supported by two members of his entourage," Stimson said.

He reported Gandhi had just mounted the covered dais from which he conducted his prayer meeting and the crowd was pressing around him when the shots were fired.

An osteopath says that people eventually will forget how to walk. Not as long as we have second-hand cars.

In an average year before World War II, U. S. transport systems carried about \$2.4 billion ton miles of inter-city freight.

Strong Arab Resistance To U. N. Partition Looms

By MAX HARRISON
AP News Writer

As the United Nations starts to oversee the partition of Palestine, the Arabs are prepared to resist with every weapon they have.

This has been made clear by numerous recent developments such as the Arab country leaders calling on all Arabs "to prepare for the struggle. It is safe to assume that Arab leaders will not hesitate to increase the spilling of blood to prevent carving up of the Holy Land."

A prominent part was played in the Arab deliberations by Haj Amin El Hussein, exiled mufti of Jerusalem who is noted as an advocate of extreme means to attain his objectives.

The mufti and his followers not only hold complete control of the Arab higher committee, principal Arab organization inside Palestine; they also have the firm backing of the Arab country governments which surround the Holy Land.

Only a few days ago, one high Arab leader in Palestine warned that the U. N.'s newly created five-member Palestine commission faced the possibility of assassination if they entered Arab-controlled areas of the Holy Land.

Under the general assembly's plan to partition Palestine, the commission is obligated to set up provisional governments in the proposed Arab and Jewish countries. It would be difficult, if not impossible, to do this without entering Arab territory.

Any physical harm to a member of the commission or even to a member of the U. N. staff, which will accompany this body, would undoubtedly confront the U. N. with one of the gravest problems in its history.

No provisions have been made,

however, to provide protection any kind for the commission after the withdrawal of British troops, now scheduled to be completed by Aug. 1.

It will be difficult for the commission to fulfill its obligations under these conditions, but it may find that a more serious problem than the threat of violence is the threat of non-cooperation.

It has been pointed out that the U. N. has enough potential strength to overcome violence eventually. But Arab non-cooperation might even jeopardize the success of the proposed Jewish government by making it economically unsound. Most of the U. N. delegates who supported the partition plan agreed that the formation of an economic union between the two projected countries was one of the prerequisites for success of the plan, since neither would be economically self-sufficient.

If the Jewish country is established without the economic union, the U. N. might have to provide for continuous economic assistance from outside the Holy Land to maintain the new government.

(Next: Jews Get Set for Independence)

Southwest Better For Sinus Trouble

SAN ANTONIO —(AP)—A Cornell University neurologist has a theory that sinus trouble may be less prevalent in the Southwest and South than in the bustling, highly competitive North.

Dr. Harold G. Wolff, of New York, told the International Post Graduate Medical Assembly of Southwest Texas here Thursday that San Antonio's popularity as a resort for persons afflicted with sinus trouble may be due to the easy-going and genial way of life as well as its usually balmy climate.

He said he had noted in his hospital practice in New York that persons suffering from complaints of a more or less "nervous" origin frequently dated the beginning of their symptoms back to the time of their arrival in "Yankeeeland."

So called "sinus infection," he said, is often the result of nervous tension and general dissatisfaction with life.

Dr. Wolff said it is quite possible that nervous troubles in general may be less prevalent in the Southwest and South than in the bustling and highly competitive North.

TRUTH
Truth is the summit of being; justice is the application of it to affairs.
—Emerson

100 WORLD'S FINEST GLADIOLUS

FOR ONLY \$1.29 POST-PAID

THIS is one of the FINEST MIXTURE of BULBS you can buy! All bulbs are size 4 & 5 and have a wide range of colors. You can have flowers continuously from this collection. This SPECIAL is for cash orders only. ORDER NOW!

BONUS! FOR PROMPT ORDER! WE WILL INCLUDE 10 GRATIS! MISC. BULBS!

MONARCH BULB FARMS
KALAMAZOO 99, MICH.

STANDARDIZATION... THAT'S THE RESULT WHEN ALL THE WOMEN-FOLKS GOES TO THE SAME BEAUTY PARLOR!

FOR FREE REMOVAL OF DEAD STOCK CALL

Phone 9037F2
Pampa

AMARILLO COMPANY

FAST SANITARY SERVICE

51 DAYS SPECIALS FOR MONDAY ONLY

MEN'S SHORT SLEEVE SWEATERS \$1.00
\$2.95 Value. Dollar Day

MEN'S PART WOOL SHIRTS \$3.95
Values to \$8.95. Dollar Day

MEN'S PLAID SHIRTS \$4.95
By ARROW Values to \$7.95 DOLLAR DAY ONLY

MEN'S ELASTIC GARTERS 10¢
Special Dollar Day

Boy's Dress Suits \$8.00
Values to \$19.95

Boy's Sport JACKETS \$2.00
Values to \$11.50 Dollar Day

Boy's All Wool JACK SHIRTS \$4.00
\$9.78 Value Dollar Day

Boy's Plaid SHIRTS \$2.95
Values to \$5.00 Dollar Day

Men's Zelan Insulated Jackets Values to 16.50 DOLLAR DAY ONLY 8.95



MEN'S FAIRFIELD Leather Palm Gloves \$1.00
\$1.39 Value—Dollar Day

Men's Plaid and Solid Color SHIRTS \$2.95
\$3.95 Values—Dollar Day Only

MEN'S RAINCOATS \$4.00
Regular \$8.50 Value. Dollar Day

MEN'S SLEEVELESS SWEATERS \$2.95
\$4.95 Value—Dollar Day

MEN'S SIX-INCH HI-TEST Saf-Toe Shoe \$5.00
Value. 3.95—Dollar Day

CLOSING OUT LADIES' BLOUSES \$2.00
\$5.00 VALUES AT

Boy's Cord BIBALLS \$2.95
3.95 values

Boy's Outing PAJAMAS \$2.95
Values to 3.50 Sizes 6 to 18

BOY'S UNIONS \$1.00
Long sleeve, ankle length, 1.95 value

Boy's Wool BIBALLS \$1.95
3.95 values

Friendly Men's Wear
"The Nationally Advertised Mens Store"
• STETSON HATS • DOBBS HATS • BOTANY FABRICS • FLORESHEIM SHOES • B.V.D. PRODUCTS.

Montgomery Ward

RECORD-BREAKING VALUES IN THIS GREAT...

Furniture Sale

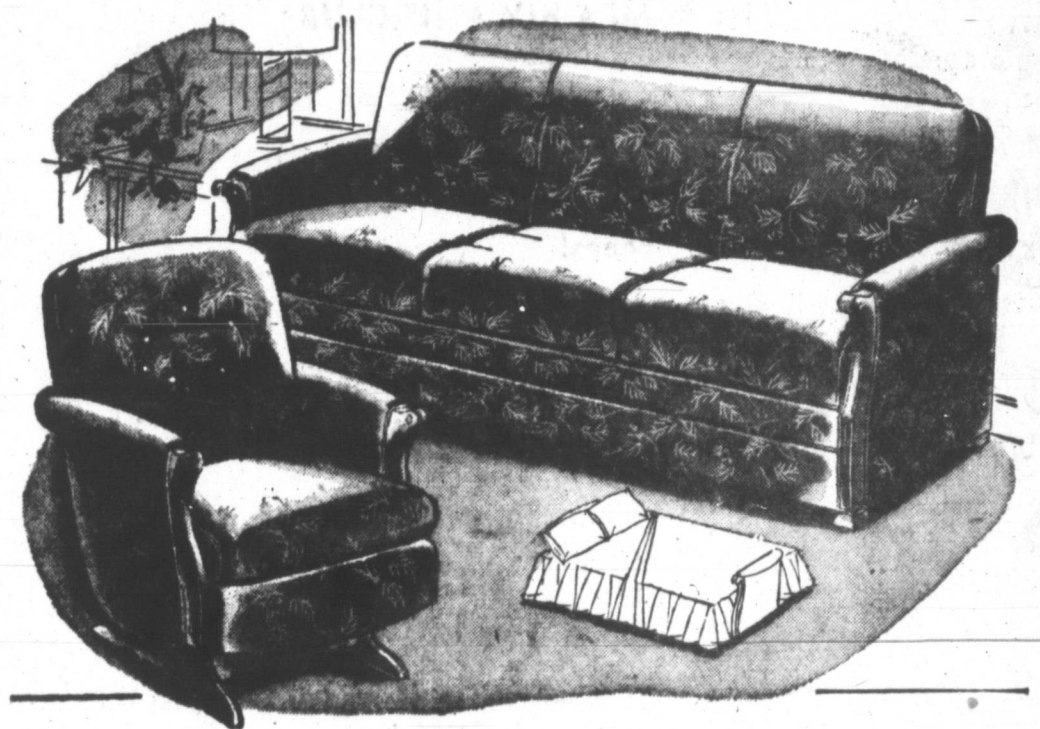

SOFA BED SUITE... SALE PRICED! 134⁸⁸

A feature of Ward's great February Sale! Sofa bed with platform rocker to match... both upholstered in lustrous Velour. They're built for long wear, and the sofa opens easily into a full-size, 162-coil innerspring bed!

On Terms: \$13.50 Down, \$9 a Month

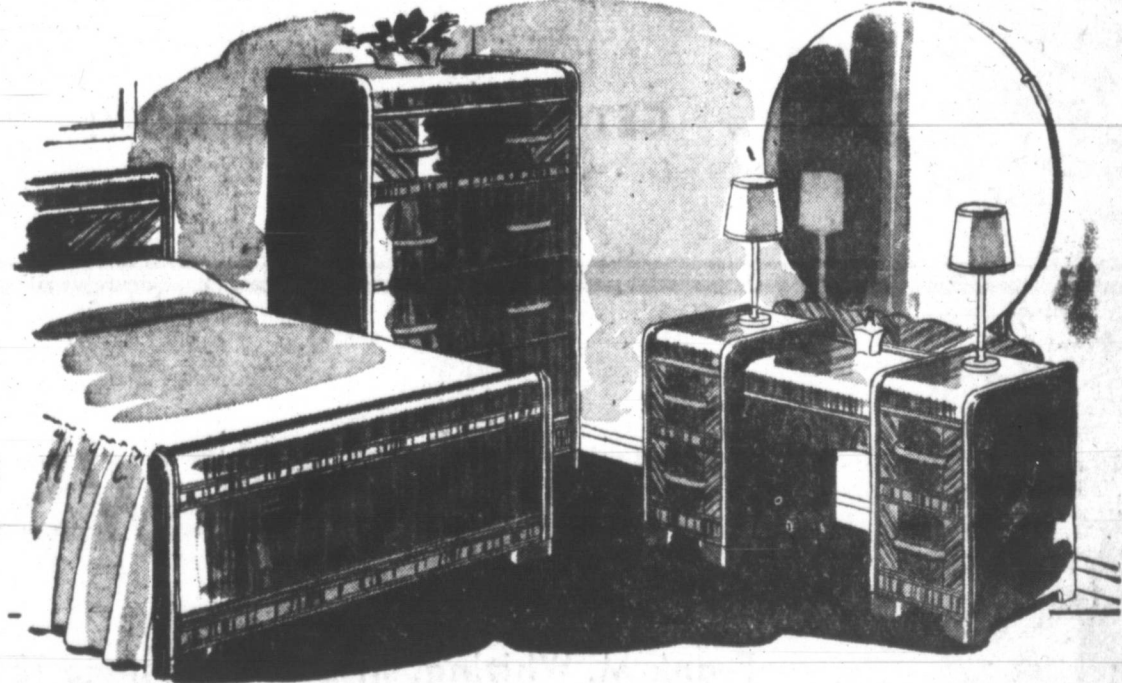

BED, CHEST AND VANITY... REDUCED! 134⁸⁸

February Special—this smart Waterfall bedroom group. Beautiful hand-rubbed Walnut veneers give a "luxury" look... and fine hardwood construction details with dovetailed, side-guided drawers mean long service!

On Terms: \$13.50 Down, \$10 a Month

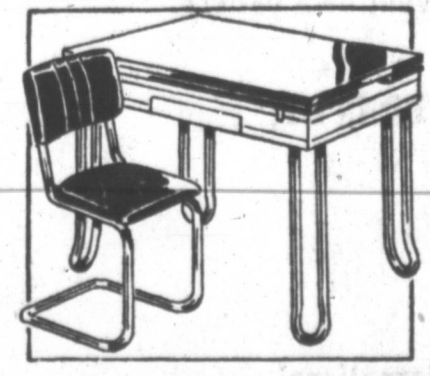

FEBRUARY SPECIAL! 5-PC. DINETTE 79⁸⁸

Porcelain-top table, four matching chairs in artificial leather... reduced!



SMARTLY STYLED LAMP TABLE 119⁵

Crafted in hardwood... ney pattern mahogany veneered top. Use in pairs!



HANDSOMELY STYLED OCCASIONAL CHAIR 164⁵

No-sag spring construction for comfort. Durable cotton tapestry covers.

Don't Miss One Bargain! Buy on Terms... \$1 Down on a \$10 Purchase

Montgomery Ward

DOLLAR DAY

The Sale Where Your Dollar Goes Further!

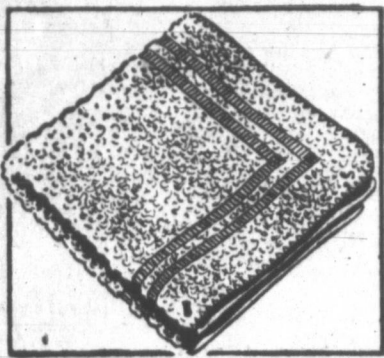

SOLID COLORED WASH CLOTHS BY "CANNON" 15' for 100

Blue, green or pink washcloths are ideal for depleted towel ensembles. 11x11'.



Men's Tie-Top Corduroy Caps Reg. 1.89 100

In bright plaids for work or sports! Wear the earlaps down for extra warmth.



BRIGHTEN YOUR BEDROOM WITH A CHENILLE SPREAD Reg. 6.98 617

Interestingly woven with alternating rows of chenille, hobnail tufts and skip stitching! It will add real beauty to your room whether period or modern. Choose blue, dusty rose, green, gold or white. It's easy to wash, needs no ironing. Full size.

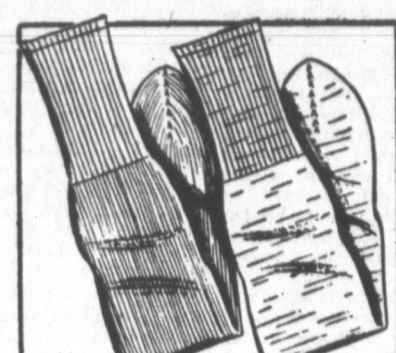

WARDS "MECHANICS" FOR RUGGED WEAR 5 pr. 100

Medium weight, long wearing cotton. Regular and slack lengths. Sizes 10-13.



New Collection of Colorful Neckwear Reg. 1.00 8 for 200

Smart, perfectly knotting rayon ties! A wide choice of patterns and colors.

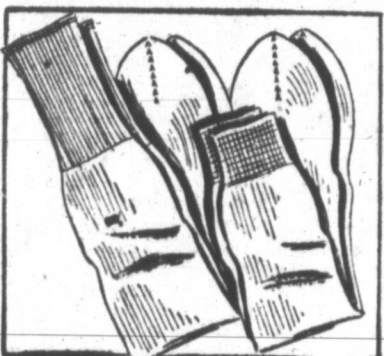

GUARANTEED HOSE 3 pr. 100

3 pr. must give 3 months normal wear, or we replace them! In neutral shades. Sizes from 10 to 13.

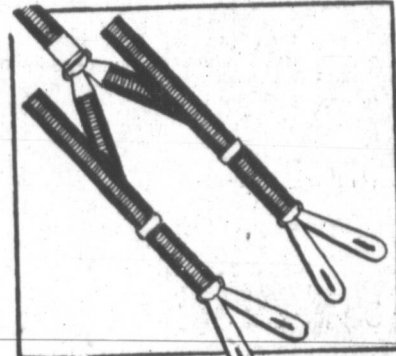

BUTTON-ON BRET BRACES FOR MEN Reg. 1.19 100

You'll get good wear from these wide elastic suspenders in assorted colors.

KEM'S CLEANING TISSUE

2-Ply Thickness. Buy Now and Save!

5 Boxes \$1.00

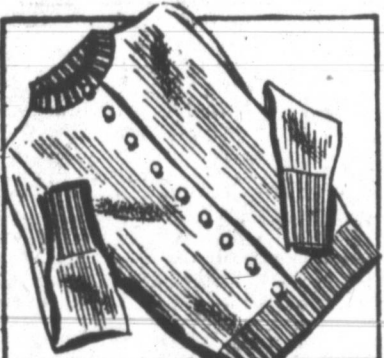

Girls' Finest All-Wool Cardigan Reg. 3.98 100

All new wool, styled with careful detailing. Pastel and brilliant shades. 7-14.

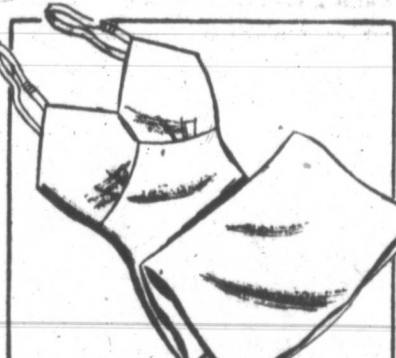

Built-Up Slip... Of Study Cotton Reg. 1.29 100

Daintily hemstitched! Sizes 34 to 44. In extra large sizes. 46 to 54. 1.59



MEN'S DRESS SHIRTS PRICED FOR SAVINGS Reg. 2.29 200

Choose from woven stripes and neat patterns. These Ward shirts are all top quality. Reinforced for good wear.



ALL-PURPOSE 27 IN. SNOW-WHITE FLANNEL 4 yds. 100

Use this absorbent white flannel for diapers and children's undergarments. Good too for nightgowns and pajamas. It's practical and economical. 27" wide.

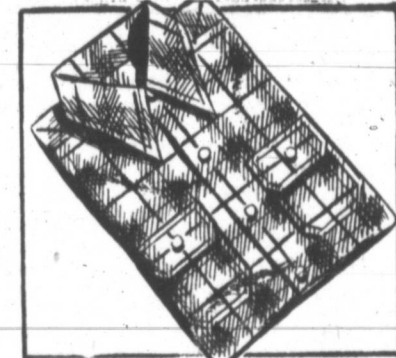

Cotton Flannel Shirts for Men Reg. 3.98 200

For work or sports! Lightweight yet warm! Assorted bright plaids 14 1/2-17.

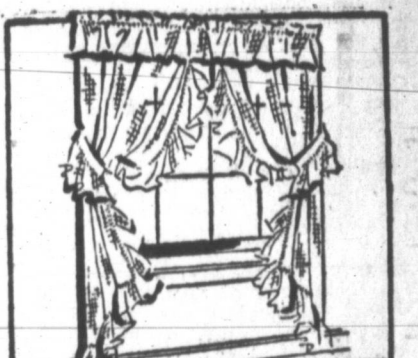

SHEER PRISCELLAS OF COTTON MARQUISSETTE Reg. 2.37 300

Better quality! Sheer and crisp-looking with deep ruffles! Each side, 51"x90".



PLAIN AND STRIPED FINE WOVEN CHAMBRAY Reg. 89c 2 for 100

A most popular yarn-dyed fabric suitable for misses' and children's wear. 36"



Save On Wards All Rayon Challis Reg. 79c 47c

Our lowest priced rayon print. Ideal for blouses and school togs. 39-inch.

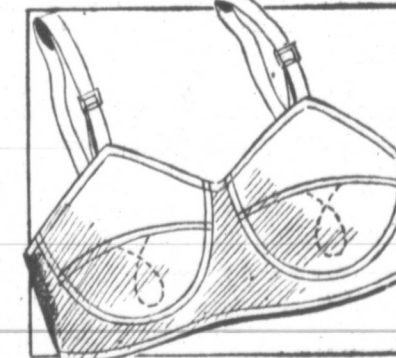

RAYON SATIN "FLEXEE" FOR YOUTHFUL UPLIFT 2 for 300

Precisely proportioned small cup style. Tapebound seams. White, tearose. 32-36

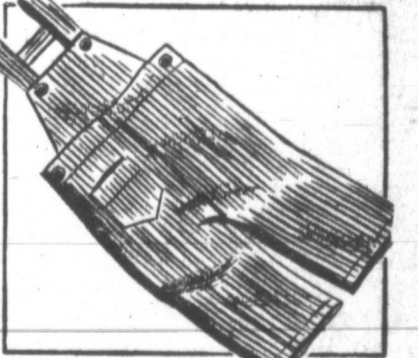

TODDLERS' STURDY CORDUROY OVERALLS Reg. 2.37 200

Practical garb for your little man's active hours. Medium blue, wine and tan.



WATERPROOFED BIKE SADDLE BAG Reg. 1.15 100

Waterproofed artificial leather. Roomy. 11-in. size. Snap fasteners, web straps.

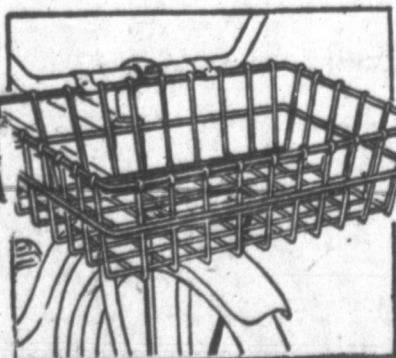

WARDS DE LUXE BIKE BASKET CARRIER Reg. 1.15 100

Big, 18x13x6-in. galvanized steel wire basket. Reinforced bottom. Complete!

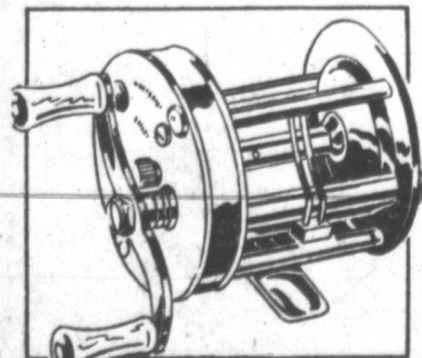

"SPORT KING" CASTING REEL 549

Chrome plated! Lightweight, levelwind with sliding click. 100-yd. capacity!

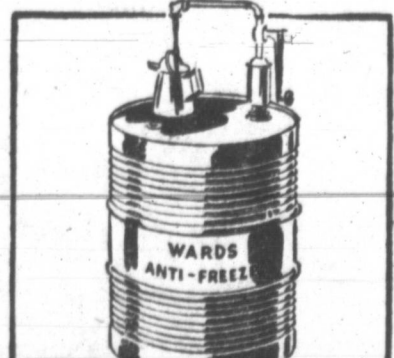

WARDS ANTI-FREEZE LOWEST PRICE IN TOWN gal. 149

Bring all your containers, stock up! Type "N" gives top freeze-up protection!

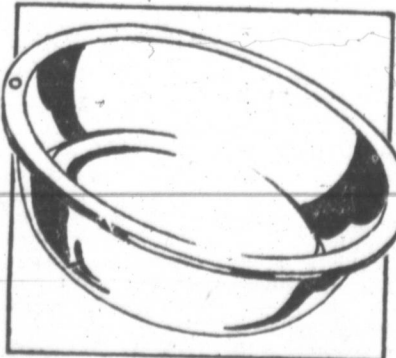

9-Qt. Dishpan Deduced from 1.09 100

White porcelain enamel, with neat red trim for a spic-and-span kitchen!



SET OF SIX 9-OZ. DECORATED TUMBLERS 12 for 69c

Clear glass tumblers, with delightful floral decoration that won't wash off!

Pampa News Most Consistent Newspaper Published daily except Saturday by The Pampa News, 221 W. Foster Ave., Pampa, Texas. Phone 216. All departments MEMBER OF THE ASSOCIATED PRESS (Full Lease Order). The Associated Press is not to be held responsible for the use of reproduction of all the news printed in this newspaper as well as all AP news dispatches. Entered as second class matter at the post office at Pampa, Texas, under the Act of March 3, 1879.

Fair Enough by Westbrook Pegler

On the evening of March 4, 1933, as I was riding down in the elevator on the high side of the Willard hotel, in Washington, the car stopped at about the eighth and a smiley, kind of jelly-belly little fellow and his misbegotten son and I and him and one of the Joseph Daniels. I think this was on F street and the side up the hill from down the hill where the lobby is. Jim Farley says he still doesn't know something pleasant about the Chinese umbrella-strand for old dead outta.

Common Ground

By R. C. HOILES

"Mainspring" a Most Important Book (Continued) I have two books on my desk. One book is "Mainspring," the story of human progress by Henry Grady Weaver. It is one of the best books I have ever read. The other is "Elements of Economics" by Lorie Tarshis of Stanford University. It is one of the worst books I have ever read. It should not be called "Elements of Economics." It should be called "Elements of Socialism." I have only found one sound thing in it. It advocates freedom of international trade but it is opposed to freedom of national trade. I will have more to say about it later.

Common Ground

By R. C. HOILES

I have two books on my desk. One book is "Mainspring," the story of human progress by Henry Grady Weaver. It is one of the best books I have ever read. The other is "Elements of Economics" by Lorie Tarshis of Stanford University. It is one of the worst books I have ever read. It should not be called "Elements of Economics." It should be called "Elements of Socialism." I have only found one sound thing in it. It advocates freedom of international trade but it is opposed to freedom of national trade. I will have more to say about it later.

TOP OF TEXAS NEWS

Shamrock McLean

SHAMROCK (Special)—Arrangements are being made to start a class in distribution education for veterans of the Shamrock area. George Gandy, coordinator for the Wheeler County vocational schools, has announced. The class would be similar to those being conducted in vocational agriculture for ex-servicemen, except it would be for those who wish to study business instead of farming, Gandy said. The school which would include salesmanship, and management, would be conducted in Shamrock. Veterans interested in the class have been asked to contact Harris Zeigler, Wheeler County Service Officer, or Gandy, giving their name and address. They will be notified of the date of a general meeting at which the class will be organized.

We Would Go Along Only on Some Points

To paraphrase Mark Twain's famous remark concerning the weather, everybody talks about inflation but no one does anything about it. The political proposals for dealing with this number one domestic problem seem unrealistic to put it mildly. Mr. Truman and his official family are still bent on rationing and price control policies which in other countries have led to declines in production and the growth of the black market. The Republicans lean to rather indefinite voluntary controls, which have been ineffective when tried in the past. In both political camps there is an obvious effort to advocate measures which will attract as many voters as possible, and stop on the minimum number of toes.

Common Ground

By R. C. HOILES

Sanitariums for Poland

By Upton Close

WROCLAW, Poland.—Two new sanitariums for tuberculosis patients, with a total capacity of 450 beds, are nearing completion in the vicinity of this former city of Breslau. The United States had about 18,000 inter-city buses in 1940.

Common Ground

By R. C. HOILES

FUNNY BUSINESS

BY HERSHBERGER



Common Ground

By R. C. HOILES

Sanitariums for Poland

By Upton Close

WROCLAW, Poland.—Two new sanitariums for tuberculosis patients, with a total capacity of 450 beds, are nearing completion in the vicinity of this former city of Breslau. The United States had about 18,000 inter-city buses in 1940.

Common Ground

By R. C. HOILES

By R. C. HOILES

Common Ground

By R. C. HOILES

By R. C. HOILES

Common Ground

By R. C. HOILES

By R. C. HOILES

Common Ground

By R. C. HOILES

By R. C. HOILES

Common Ground

By R. C. HOILES

By R. C. HOILES

Common Ground

By R. C. HOILES

By R. C. HOILES

Common Ground

By R. C. HOILES

By R. C. HOILES

Common Ground

By R. C. HOILES

By R. C. HOILES

CLASSIFIED ADVERTISING... Classified ads are accepted until 5 p. m. for week day publication...

CARDS OF THANKS... In My Father's House are many memories...

FIELD RESUME UNDERTAKEN... AUSTIN—A comprehensive summary of the oil fields of Texas is a new project to be undertaken by the University of Texas Bureau of Economic Geology.

BRUCE & SONS TRANSFER... Local and long distance moving... FRANK'S STORE... 108 1/2 W. Foster Phone 2082

SEPTIC TANKS AND CESSPOOLS... We have new modern equipment to clean them properly... PAT THOMPSON, 111 N. West, Ph. 1428W

D. L. ALLEN... Re-Shingle That House Now! No Money Down - - - 3 Years To Pay

FURNISHINGS FOR THE HOME... Living room suites, bedroom suites, mirrors, pictures, lamps, magazine racks and many other items for the home.

STEPHENSON FURNITURE... 406 S. Cuyler Phone 1688

CHRYSLER, PLYMOUTH SERVICE BEAR WHEEL ALIGNMENT... Phone 346 315 W. Foster

Special Notice... Pampa Monument Co. 601 E. Harvester Phone 1152

Personal... Satisfaction Guaranteed... MRS. C. C. CHANDLER

Lost and Found... EAGLE RADIATOR SHOP 516 W. Foster Phone 547

Garages... Pampa Safety Lane—Ph. 101

Transportation... Local Hauling—Phone 880

Watch Repair... Dependable watch and clock repair...

Financial... WANTED small natural gas royalty payments...

Shoe Repairing... Goodyear Shoe Shop 115 W. Foster, Pampa, Tex.

General Service... Stoves, Heaters Adjusted... G. C. COX, Representative

Painting-Paperhanging... NORMAN, Painting and Paperhanging...

Upholstering-Repair... J. E. BLAND'S SHOP Upholstery, Refinishing

Laundry... Ideal Steam Laundry... Phone 608

Laundry (cont.)... Ideal Steam Laundry... Phone 608

Laundry (cont.)... Ideal Steam Laundry... Phone 608

Laundry (cont.)... Ideal Steam Laundry... Phone 608

Laundry (cont.)... Ideal Steam Laundry... Phone 608

Laundry (cont.)... Ideal Steam Laundry... Phone 608

Laundry (cont.)... Ideal Steam Laundry... Phone 608

Laundry (cont.)... Ideal Steam Laundry... Phone 608

Laundry (cont.)... Ideal Steam Laundry... Phone 608

Laundry (cont.)... Ideal Steam Laundry... Phone 608

BELIEVE IT OR NOT!! Alfalfa hay, per bale \$1.45... Purina 20 percent cubes ton \$99.00

HARVESTER FEED CO. 800 W. Brown Phone 1130

WE CAN HELP YOU FIND THE CAR YOU NEED! 1946 Chevrolet Fleetmaster Sedan, extra clean.

ZENITH RADIOS Clear tone, perfect reception. We have them in cabinet and table models; also portables.

THOMPSON HARDWARE Les Saltzman at P. K. One Stop Experienced Mechanic for Complete Auto Service.

FUGATE'S UPHOLSTERY SHOP We do upholstery and furniture repair work. Bring those shabby pieces of furniture to us and see how lovely they can look at so little cost.

YOUR ELECTROLUX AT PRE-WAR PRICE Free demonstration in your home or office on request.

HOGUE-MILLS EQUIPMENT CO. Motor Trucks - International Tractors - Farm Equipment

JONES MARKET You'll find the new arrangement of price markings a great help in your budgeting.

JONES MARKET 503 S. Barnes Phone 2262

FRIED CHICKEN Get the Best - - - Battery Fed W. C. Havens 501 E. Tyng St.

A COMPLETE FLOOR SANDER RENTAL SERVICE Our new High-Speed Floor Sander does excellent work.

LET'S ALL ATTEND OUR CHURCHES TODAY I have on hand a very nice supply of nursery stock at this time.

HALL'S NURSERY Highway 60 East Star Courts

LUZIER'S COSMETIC STUDIO Cosmetics and Perfumes... THELMA HODGES, Distributor

JUST ARRIVED—OUR NEW SPRING AND SUMMER FABRICS of latest styles, patterns and color schemes for your selection.

MRS. VERA STEPHENS Slip Cover and Drapery Shop. - - - at Pampa Craftshop

DID YOU KNOW THAT Woodie is in St. Louis, Mo., where he is attending a carburetor school in order to bring the newest and best information and service to his customers for automotive service.

WOODIE'S GARAGE 308 W. Kingsmill Phone 48

TOP PRICES PAID FOR HEAVY HENS Bring them in early each week... We retail fresh country eggs.

BOND PRODUCE 911 S. Barnes Phone 185

DES MOORE—TIN SHOP Dependable work done on floor furnaces.

HILL CREST, the Restful Beauty Shop Relax in a quiet, refined shop - - -

FRANK'S STORE 108 1/2 W. Foster Phone 2082

SEPTIC TANKS AND CESSPOOLS We have new modern equipment to clean them properly.

PAT THOMPSON, 111 N. West, Ph. 1428W

D. L. ALLEN... Re-Shingle That House Now! No Money Down - - - 3 Years To Pay

FURNISHINGS FOR THE HOME Living room suites, bedroom suites, mirrors, pictures, lamps, magazine racks and many other items for the home.

STEPHENSON FURNITURE 406 S. Cuyler Phone 1688

ELECTRIC SUPPLY CO. Pampa's Electric Headquarters

RADCLIFF SUPPLY CO. V-Belts for Electric Refrigerators, Washing Machines and all motors.

THE PUBLIC MARKET Will supply your table with best of fresh foods and meats at all times.

E. E. Smith, Owner and Manager 414 S. Cuyler Phone 880

PAMPA MATTRESS CO. Let us make your mattress to your specifications.

PIANOS, RADIOS, MUSICAL INSTRUMENTS We now have a complete line of merchandise for your musical needs.

PAMPA MUSIC STORE 214 N. Cuyler Phone 689

VENETIAN BLINDS Custom made to order. We do repair work on wood and metal blinds.

VENETIAN BLIND FACTORY 843 S. Fauxner Phone 1863

WOODIE'S GARAGE 308 W. Kingsmill Phone 48

TOP PRICES PAID FOR HEAVY HENS Bring them in early each week... We retail fresh country eggs.

BOND PRODUCE 911 S. Barnes Phone 185

DES MOORE—TIN SHOP Dependable work done on floor furnaces.

HILL CREST, the Restful Beauty Shop Relax in a quiet, refined shop - - -

FRANK'S STORE 108 1/2 W. Foster Phone 2082

SEPTIC TANKS AND CESSPOOLS We have new modern equipment to clean them properly.

PAT THOMPSON, 111 N. West, Ph. 1428W

D. L. ALLEN... Re-Shingle That House Now! No Money Down - - - 3 Years To Pay

FURNISHINGS FOR THE HOME Living room suites, bedroom suites, mirrors, pictures, lamps, magazine racks and many other items for the home.

STEPHENSON FURNITURE 406 S. Cuyler Phone 1688

ELECTRIC SUPPLY CO. Pampa's Electric Headquarters

RADCLIFF SUPPLY CO. V-Belts for Electric Refrigerators, Washing Machines and all motors.

THE PUBLIC MARKET Will supply your table with best of fresh foods and meats at all times.

E. E. Smith, Owner and Manager 414 S. Cuyler Phone 880

PAMPA MATTRESS CO. Let us make your mattress to your specifications.

PIANOS, RADIOS, MUSICAL INSTRUMENTS We now have a complete line of merchandise for your musical needs.

PAMPA MUSIC STORE 214 N. Cuyler Phone 689

VENETIAN BLINDS Custom made to order. We do repair work on wood and metal blinds.

VENETIAN BLIND FACTORY 843 S. Fauxner Phone 1863



OFFICE NURSE By Adelaide Humphries... 'Of course she is!' Her mother said now, helping her up, as she always did. 'I was overwhelmed, too. You could have knocked me flat with a flick of your wrist when I opened the door and there stood Ben. And he does look the same, if a bit taller and bigger. I kept wishing you'd be just the same; Ben—if you knew how I wished it!'

'You're not such a wow as a correspondent yourself, young man,' Janice managed to retort. 'I can only make an X for my name.' He gave her his wide grin. 'And I was kind of busy myself, at times.' He became magnanimous. 'But I forgive you, my dove. On condition that you make up for your sag neglect now that I'm home again.'

Power Shortage
 Restrictions on electric current consumption by Swiss industries have been removed after snow and rain raised water levels and assured normal production by hydroelectric plants.

The music to which are set "God Save the King" and "My Country 'Tis of Thee" is also used for national songs of Germany and Switzerland.

MANGER CROSS

Holy Bible.
 Great multitudes gathered on shore as He went into a ship and spake many things unto them in parables.
 Mat. 13:1-3.



ARRANGED AND SPONSORED FOR THE PEOPLE BY
Donnel Carmichael
 PUBLISHED BY THE FRANKLIN LIFE INSURANCE CO.
 677 N. W. 10th St., Pampa, Texas

RFC ADVISES SMELTER BE KEPT IN OPERATION

By **TEX EASLEY**
 WASHINGTON—(AP)—Continued operation of the mammoth Texas City (Tex.) tin smelter, by private industry aided by some form of government subsidy, has been recommended to Congress as a national defense measure by the Reconstruction Finance Corporation.

RFC said the Texas City plant is one of the largest in the world and the only one in this country. It was based on plans smuggled out of Holland while that country was occupied by the Nazis.

During the war the Texas City government-operated plant supplied more than 50 percent of all new tin used in this country, the RFC reported, with the percentage going up to 70 percent of domestic consumption in 1946.

The 1947 production dropped, however, due to curtailed delivery of materials from strike-bound acid plants and disrupted transportation resulting from the explosions which wrecked Texas City.

The smelter itself was not damaged by the catastrophe which took hundreds of lives.

In part the report to Congress said: "The RFC believes that a domestic tin smelting industry is important for national defense, particularly during the next five to ten years, the estimated time required to accumulate an adequate supply of tin metal in the permanent stockpile."

"To maintain the operation... it will be necessary either to continue government operation or to provide a subsidy for private industry."

"We believe that continued government operation should be considered only as an emergency measure. There are many objections to the government engaging in commercial business."

Private industry should be subsidized so that it can compete with foreign smelters operated with cheaper labor, the RFC said.

The report explained that the subsidy could take the form of a purchase and sale arrangement for tin concentrates or tin metal whereby a government agency would absorb any loss; it could involve a direct subsidy payment per pound of tin produced; or it could be in the form of an import duty on tin metal with tin ores admitted duty free.

The RFC is authorized to operate the Texas City plant which cost \$8,273,127 until June 30, 1948.

The plant started operating in April, 1942, when the Germans and Japanese were taking over Holland, Africa, Malaya and the Dutch East Indies.

Prior to the war, the United States consumed annually from 60,000 to 70,000 long tons of primary tin, nearly 50 percent of the world's production.

With no known domestic deposits of any significance, this country turned to Bolivia as the

On Mystery Trip



Above is Prof. G. E. Berven, famed Swedish cancer specialist whose recent mystery flight to Moscow to treat an unnamed patient kindled unconfirmed reports that Stalin was critically ill and dying.

only important source of tin in the Western Hemisphere. Bolivia's pre-war production of 40,000 tons of tin a year in the form of concentrates had all been shipped to Europe for smelting.

The peak production at Texas City was 43,360 tons in 1946, the 1947 estimated production was down to 35,000 tons.

City tin smelter was a necessity during the war and has been essential during the postwar period," the report said. "By the end of 1949 or in 1950, the United States should again be able to fill its tin metal requirements from foreign smelters."

Sea Casts Up Some Pin Money

COPENHAGEN—(AP)—An enormous school of mackerel recently was thrown up on the shore of the Danish island of Aeroe. People shoveled the fish into trucks and sold them to a rendering factory. A married couple in a few hours earned \$40 shoveling up four tons of dead fish.

A member of the oak species grown in the western Mediterranean area yields cork.

JEFF D. BEARDEN
 Representing
THE FRANKLIN LIFE INSURANCE CO.
 Phone 67 Pampa, Texas



KEEPING PACE...

We are constantly changing and improving our stocks of drugs... and unlike fashions, this isn't fad that prompts us to do this, but each change is a definite improvement in the drug itself or the technic of preparation. Each change has been carefully checked and rechecked to insure its safety in the preparation of your prescriptions.

WILSON DRUG

300 S. Cuyler

Phone 600

DOLLAR DAY

WASH CLOTHS
 Heavy weight Turkish Wash Cloths in every color \$1.00 for 10 (Downstairs Store)

TURKISH TOWELS
 Here is a real buy in heavy weight Turkish Face Towels; solid colors of blue, green, pink, yellow and peach. Each 29c (Downstairs Store)

CUTTING FLANNEL
 Soft flannel cutting in solid colors of white, pink or blue; also stripes in dark and light colors. Real Dollar Day value, 4 yds. \$1.00 (Downstairs Store)

BIRDSEYE DIAPERS
 Genuine bird's eye weave 27x27 size, specially priced. Dozen \$2.39 (Downstairs Store)

BROWN DOMESTIC
 Pick up what you need now at this low price; hundreds of household uses. 5 yds. \$1.00 (Downstairs Store)

REMNANTS
 One group of remnants. Consists of print, woolen, rayon and other materials. 1/2 Price (Downstairs Store)

One Group PIECE GOODS
 Consists of gingham, chambray and cotton prints—Dollar Day Special \$1.00 3 yds. (Downstairs Store)

We have just received a new shipment of—
LACE PANELS
 Decorate your home for spring— \$1.98 to \$3.49 (Downstairs Store)

Girls' Rayon Panties
 Elastic all around all sizes. 4 pr. \$1.00 (Downstairs Store)

Nashua White Cotton Sheet Blankets
 72"x99" Downstairs Store \$2.69

Children's Anklets
 Regularly priced to 39c. Sizes 6 to 8 1/2—Dollar Day Special 4 pr. \$1.00 (Downstairs Store)

For Dollar Day! One Special Rack

LADIES' DRESSES

Formerly Priced to \$16.98

DOLLAR DAY

5.00

A special purchase enables us to bring you this outstanding value. . . Formerly priced to \$16.98.

- Crepes, gabardine and alpaca
- Black and colored styles
- Black, brown and pastel gabardines
- Sizes 9 to 20, 38 to 52. Large selection.



One Special Group of Children's and

Women's Shoes

Broken sizes—Dollar Day \$1.00

Pair Formerly priced to \$5.98—

Women's **ANKLETS**

English rib Dovedown, all sizes and colors. Dollar Day Special \$1.00

3 pr.

HANDBAGS

One group of kidskin and patent leather—Dollar Day Closeout \$1.98 (Plus tax)

Mirror Cosmetic Kits

Ladies, look at this extra value. Several patterns . . . plus tax \$1.98

Taffeta Slips

One special group. All sizes—Former val. \$2.39 to \$2.98 \$2.39

Lingerie

Shop our lingerie department for outstanding values in "Blue Swan" underthings. colors of blue, yellow, tea-rose and white—

Panties 98c

LADIES' BLOUSES

Shirtwaist and fancy styles. All sizes. White and colors, stripes and solids—Former values to \$4.98 Dollar Day \$1.99 Special . . . \$1.99

Slips \$1.98-\$3.98

Gowns \$2.98-\$3.98



Men's T-Shirts

Crew neck, mercerized knit Tee shirts; ideal for sport or undershirts. \$1.00

2 for

Men's FLEECE LINED Sweat Shirts

Heavy quality Reg. \$1.69 value \$1.00

Men's Hankies

White, large size, high quality. 8 for \$1.00

Men's Undershirts

Lisle knit in Swiss and panel rib. 3 for \$1.00

Men's Socks

Short Tops Only

Ideal work socks, all sizes, white and colors—4 pair . . . \$1.00

Pajamas

Printed broadcloth, neat print and stripes, fast colors and sanforized. Reg. priced \$2.39 to \$6.98 \$2.39



Special Group Men's

FELT HATS

Values to \$10.00

Dollar Day Special **5.00**

BOYS' RUBBERS

One group, sizes 3 to 6. \$1.00

Dollar Day Special

Closeout Boys' Pants

Boys' corduroy and tweeduroy. Sizes 4 to 16. Colors of brown and blue only—Regular \$4.95 \$2.49

Dollar Day Special (Downstairs Store)

New Arrivals



CHOOSE YOUR

SPRING COAT AND SUIT NOW

Use Our Convenient Lay-Away Plan \$2 Down

\$19.98 to \$49.50

Plan now to attend the Kiwanis-sponsored **Top o' Texas Revue** February 2nd and 3rd, 8:15 Each Evening.

Betty Rose and Mary Lane

LEVINE'S "WHERE YOUR DOLLAR IS STILL WORTH A DOLLAR"