

CHILDREN'S CHRISTMAS CANTATA SUN. MORNING

The Wheeler First United Methodist Church will be presenting its annual Children's Christmas Cantata, Sunday, Dec. 15, 1991 at 11:00 a.m. in the church Sanctuary. The play, entitled "Rip Van Christmas," is the story of a group of children who learn that in order to experience Christmas God's way, they must put aside their personal differences and find unity in Jesus Christ. The cantata will also be performed at the Wheeler High School Auditorium at 9:00 a.m. on Dec. 20, 1991. Everyone is cordially invited to attend.

The Wheeler First United Methodist Church will be presenting its annual Children's Christmas Cantata, Sunday, Dec. 15, 1991 at 11:00 a.m. in the church Sanctuary. The play, entitled "Rip Van Christmas," is the story of a group of children who learn that in order to experience Christmas God's way, they must put aside their personal differences and find unity in Jesus Christ. The cantata will also be performed at the Wheeler High School Auditorium at 9:00 a.m. on Dec. 20, 1991. Everyone is cordially invited to attend.

The Wheeler First United Methodist Church will be presenting its annual Children's Christmas Cantata, Sunday, Dec. 15, 1991 at 11:00 a.m. in the church Sanctuary. The play, entitled "Rip Van Christmas," is the story of a group of children who learn that in order to experience Christmas God's way, they must put aside their personal differences and find unity in Jesus Christ. The cantata will also be performed at the Wheeler High School Auditorium at 9:00 a.m. on Dec. 20, 1991. Everyone is cordially invited to attend.



THE WHEELER TIMES

(USPS 681-960)
VOLUME 58, NUMBER 1

THURSDAY, DECEMBER 12, 1991

Single Copy: **35¢**

"Wheeler, town of friendship and pride."

\$400 'CASH' IN SECOND DRAWING SAT.

CWE CHAT WITH EDITOR
By Louis C. Stas

Congratulations are in order for **Amanda Flanagan** and **Wade Hampton**; they earned a chair in the Regional Band. Amanda plays the clarinet and Wade plays the trombone.

Santa made his visit to Wheeler Saturday afternoon and there was a large group of youngsters on hand for the visit.

The square certainly looks nice, but it appears there is going to be some problem keeping the lights burning. I tipped my hat to David Wright last week for his work on the project, and he informed me that I should have taken my hat off to **Jason** and **Ashley Brownfield** and especially to **SPS employees, Marshall Andis** and **Harold Estes** for their considerable efforts to make the town square Christmas lighting possible.

Next week will be the annual Christmas Greeting edition of the Times. We hope we will have contacted all the businesses by Thursday afternoon. If we have failed to make contact with any business or individual by Thursday and you would like a Christmas Greeting, please feel free to call 826-3123. It saves postage.

It's a boy! **Jared Keith Forrester** made his appearance on Friday, December 6. Now I am sure that Grandma Patricia thought this little item needed to be at the top of the column. Congratulations to parents **Curtis** and **Sherri Forrester** of Carrollton. Further details can be found under *New Arrivals*.

Basketball is well underway. The annual Wheeler tournament begins today, Thursday, and continues through Saturday.

We were informed that **Monk & Norma Bowerman** will observe their 58th Wedding Anniversary Sunday, Dec. 16. Monk is a retired mechanic and Norma is a retired cook. The couple resides at 1000 S. Red River.

Joe Weatherly may get to come home Friday after undergoing open heart surgery last week.

On the Road Again would explain the past weekend in a few words. We had to go to Hamilton to attend a birthday-family reunion for our 'adopted' family. The birthday 'girl' was **Leora Elmore**. Leora's sister contacted members of the Hale family and a family reunion was arranged with guests from Texas, Oklahoma and Arizona.

Now to explain. **Emma Connell**, a Hale and Leora's aunt, was **Ronal Wayne** and **Cathi's** other grandmother. She started keeping **Ronal** just after his first birthday and had **Cathi** from the beginning. She passed away shortly after **Cathi's** 13th birthday, three months before **Jennifer** was born.

In case you don't remember, **Hamilton** is six hours from Wheeler and every mile is there. We even checked from one sign to the next to make sure they were right.

We had a great time and even met some more 'family' members from **Snyder, Okla.**, and **Sun City, Arizona**.

Greetings are extended from the **Hamilton Elmore's** to the **Allison Elmore's**.

Remember the drawing Saturday afternoon.



ALL REGION BAND: The Wheeler Mustang Band had two members earn a place in the All Region Band Monday. Four were named alternate members. **Wade Hampton** and **Amanda Flanagan** (back row, right) were named to the All Region Band. Alternates are (front row, l. to r.) are **Erica Puryear**, **Rowdy Reimer**, **Lori Morrison** and **Jessica Jackson**.

TOYS FOR TOTS DRIVE

The Wheeler County Sheriff's Office and AmWest Savings of Shamrock are going to sponsor a county wide "Toys For Tots" drive. The purpose of the project is to provide toys for youngsters who would otherwise be without gifts on Christmas. The people of Wheeler County are asked to share with those less fortunate. Toys, new or used (clean and useable). Barrels for depositing of toys will be placed at the following locations: First State Bank of Mobeetie, First National Bank in Wheeler, Thriftway, Lane's Grocery in Allison, Elevator Cafe in Briscoe, Wheeler Sheriff's Office, and AmWest Savings at Shamrock. Any donation of toys would be appreciated.

Hospital Notes

- Old Admissions**
11-24 Cecil Bailey
11-25 Ethel McWhorter
Jewel Leonard
Lewis Rogers
- New Admissions**
12-2 Mildred Williams
Frank Walker
Tonia Webster
Myrtle Dearing
12-3 Julia Massey
12-4 Phillip Gaines
12-5 Bob Markham
Myrtle Bryant
12-7 Thomas Daughtry
12-8 Seth McWhorter
Willie Morris
Earnest Foshee
Grace Pettit
- Dismissals**
12-2 Danny Nelson
12-3 Ronald St. John
Irene Moore
Charlotte Chapman
Becky Case
Margaret Oldham
12-4 Tonia Webster
12-5 Phillip Gaines
12-7 Thomas Daughtry
12-8 Myrtle Dearing
Seth McWhorter



ALPHA MU ALPHA CHRISTMAS BASKET Alpha Mu Alpha is selling chances on their Christmas basket to be given away Christmas Eve at the drawing. Proceeds are used to benefit Senior Citizens, Wheeler Fire Department, Wheeler Ambulance and a Senior Scholarship. The basket will be on display at **Andie's** and **Hyland's Pharmacy** thru Christmas Eve. Tickets may be purchased at the businesses listed above or from any Alpha Mu Alpha member.

12 SHOPPERS WIN 'CASH' SATURDAY

The first of four Wheeler 'Cash' drawings was held Saturday, December 7. The drawings are sponsored by the Wheeler Chamber of Commerce and are held on the west side of the square. A large crowd gathered on the sunny afternoon in hopes of taking home some of the 'cash'.

\$300 was divided and placed into 16 envelopes. Two individuals were not on hand when their names were drawn.

Services Held Monday For Doris L. Newsom

Doris L. Newsom, 83, died Saturday, Dec. 7, 1991.

Services were held at 2:00 p.m. Monday, December 9 at Allison First Baptist Church. Rev. Andy Taylor and Rev. Ronnie Chadwick, pastor officiated. Burial was in Zybach Cemetery by Wright Funeral Home of Wheeler.

Mrs. Newsom was born in Canton, S.D. She received her master's degree in English education from West Texas State University. She had lived in Allison since 1932. She was a school teacher in Allison schools for 37 years. She was a member of Allison First Baptist Church, where she taught Sunday school for many years.

Survivors include a son, **Leslie Newsom** of Odessa; two daughters, **Dorothy Welch** of Amarillo and **Vivian Swires** of Canadian; a brother, **Lee Richardson** of Stinnett; four sisters, **Edith Donaldson** and **Edna May**, both of Allison, **Hazel Gamel** of Uvalde and **Ava Corn** of San Antonio; seven grandchildren; and three great grandchildren.

Pallbearers were **Hiram Begert**, **Bobby Cornell**, **Lee Hall**, **John Huff**, **Alton Lohberger**, **Donald Williams**.

Honorary Pallbearers **Clyde Dukes**, **Glen Elmore**, **Don Holbrook**, **Loyd Jones**, **Domer Miller**, **Zeland Rainey**.

Santa Letters To Be Published

Hey Kids! Christmas is just around the corner and Santa Claus is so busy at the North Pole in his toy shop that he has asked the "Times" to help him out with his Christmas mail.

All you little boys and girls through the third grade are asked to help Santa also by sending your letters to Santa Claus to "The Wheeler Times" to be published.

Teachers, if you would like to help the children with their letters as a class project, please see that the letters are clearly printed and that they reach the "Times" office on time.

Older Santa will read all the letters in one issue, thus cutting down on his mail. Also you won't be taking a chance of your letter getting lost in the snow.

Kids, read these instructions carefully. Write your letter, using 30 words or less, mail it to The Wheeler Times, Box 1080, Wheeler, TX. 79096, so that the "Times" will receive it by December 12th.

Wheeler Invitational Basketball Journey, Thursday thru Saturday Wheeler, Follett, Childress, Shamrock, Canadian and Wellington will participate

The second of the \$1500 Chamber of Commerce Christmas drawings will be held Saturday, December 14; \$400 will be given away. The first three of the drawings will be held on Saturday; the final drawing will be held Tuesday, December 24.

The drawing Saturday will be at 2:30 P.M. with 17 individuals being made richer. The division of the money will be 10-\$10, 4-\$25; 2-\$50 and 1-

Wheeler Bands Present Christmas Concert Sun.

The Wheeler Bands will present their annual Christmas Concert Sunday, December 15 at 2:30 p.m. in the High School Auditorium. Selections will be performed by the Fifth Grade Band, the Junior High Band and the High School Band.

This year's concert will feature traditional Christmas songs by famous composers along with raw and exciting music by composers who would like to be famous. We hope to see everyone for an enjoyable, fun afternoon. Admission is free.

Viola Hungate was the big winner of the day, having her name drawn for the \$100 in 'cash'. Her name had been drawn earlier for \$10.

Second on the list of big winners would be **Tina Alley**. She had her name drawn twice; each time she claimed a \$25 envelope. The other two Wheeler shoppers present to claim \$25 envelopes were **Lina Jackson** and **Melinda Whorton**.

The first \$100 given away Saturday was shared by 10 individuals. Ten \$10 envelopes were handed to **Frank Woodward**, **Jay Vandelen**, **Scott Dunnam**, **Dale Earl**, **Frankie Fletcher**, **Claudy Brotherton**, **Viola Hungate** and **April Hampton**. **Laneta Arganbright** had her name drawn twice and claimed a \$10 envelope each time.

Remember, the drawings will be broadcast by KPDR-FM, 90.5, on the radio dial. This means you can remain in your car and keep warm as you wait for your name to be drawn.

Shoppers are reminded of the rule for claiming the envelopes. Husband and wife may claim each other's envelopes, but children cannot claim their parent's envelopes nor parents their children's winnings.

Saturday, December 14, 1991, will be the second drawing and \$400 will be given away.

New Arrival

Jared Keith Forrester Curtis and Sherri Forrester announce the arrival of their son, **Jared Keith**, on Friday, December 6, 1991, in Carrollton, Texas. Jared weighed in at 7 lbs. and 4.5 ozs. and measured 19.5 inches long.

Grandparents are **Ed and Patricia Forrester** of Wheeler, **Bob and Willie Johnson** of Dallas. Paternal great grandparents are **Mr. and Mrs. Otto Forrester** of Wheeler and **Mr. and Mrs. Robert Cosper** of Bedford, Tex.

Elaine Christine Martin Tyler Martin, welcomes baby sister, **Elaine Christine**, born Dec. 4th at 3:42 a.m. Elaine weighed 7 lbs. 5 ozs. Parents are **Dr. Ray** and **Dr. Jean Lee Martin** of Mansfield, Mass. Grandparents are **Frank and Margaret Martin** of Blair, OK.; **Bill and Jane Bernard** of San Antonio, TX.



WHEELER FFA Wheeler FFA members **Darren Brown**, **Corey Case**, and **Danny Brinkley** recently competed in the Top-O-Texas District FFA Leadership Contest at Clarendon Jr. College. Their skill demonstration of How To Use, P.V.C. Pipe placed first in the district and sixth in the Area I FFA Leadership Contest. Pictured with the team members is **Mr. Clifton Morgan**, student teacher advisor and team coach.

The division for the third of the drawings, December 21, will be the same as this week.

On Tuesday, December 24, Christmas will be a little brighter for eight "Wheeler Shoppers"; they will share in the \$400 to be given away at that time. The "money" will be divided into 4-\$25, 2-\$50 and 2-\$100 envelopes.

As has been the practice for the past several years, script is given away to the lucky individuals instead of cash. The script can be spent like money with any of the participating merchants. The 'money' will be in \$5 increments.

Remember, each time you enter participating stores, you are entitled to a ticket; ask for it, sign it, deposit the ticket in the containers, which are conveniently located in the sponsoring firms.

You will receive one ticket per each dollar of the purchase value-up to a maximum of \$500.

When the day of the drawing arrives, all of the tickets will be placed in a large container and the winners drawn. You MUST be present to win; however, husbands and wives may claim each other's prizes.

Each sponsor giving tickets will display a poster in their window, indicating they are giving drawing tickets.

Drawing tickets have been available since Friday, November 29, 1991 at sponsoring businesses.

Methodist, Baptists Will Present Cantata Sunday

The combined adult choirs of the Wheeler United Methodist Church and the Wheeler First Baptist Church will present the Christmas Cantata, A Simple Christmas, at 7:00 p.m. on Sunday, December 15, 1991, at the Wheeler United Methodist Church. A musical prelude by organist **Amelia Sims** and pianist **Martha Helton** will begin at 6:30 p.m. A Simple Christmas by **Lani Smith** is a combination of traditional and original Christmas music with narration that emphasizes that the true meaning of Christmas is not in the confusion of our earthly festivities, but in the simple birth of God's Messiah, Jesus Christ. Please join us for this celebration of Christ's birth.

Graveside Services Are Wed. For Lynn Ford

Lynne Ford, 53, died Monday, December 9, 1991.

Graveside services were held at 10:30 a.m. Wednesday in Wheeler Cemetery. Rev. **Ricky Pfeil**, pastor of Wheeler Christian Center, officiated. Arrangements were by **Wright Funeral Home**.

Mrs. Ford, born in Spokane, Wash., moved to Wheeler from California in 1976. She married **Donald Ford** in 1976 at Las Vegas. She was a homemaker and a member of the Wheeler Christian Center.

Survivors include her husband; three sons, **Arlan Phipps**, **Theodore Phipps** and **Russell Phipps** of Amarillo; her mother, **Margaret Heide** of Wheeler and five grandchildren.

WHEELER POST OFFICE NOTICE

Wheeler Post Office will remain open during noon hour 1:00 p.m. to 2:00 p.m. until Christmas for your convenience

Those merchants sponsoring the drawings and giving tickets are: **Lee Hardware**, **L. & F. Repair**, **Dairy Queen**, **Marshall Discount Auto**, **Albert's Shamrock**, **J. B. Muffler**, **V. & S. Variety**, **Wheeler Lumber**, **McIlhany's Dry Goods**, **After Hour Video**, **Bob's Tackle Shop**, **Flowers 'N Things**, **Frankenberry Texaco**, **Hyland's Pharmacy**, **Pierce's Trading Post**, **Thriftway Grocery**, **Ware Chevrolet-Buick-Olds-Pontiac**, **Johnny's Shamrock**, **Andie's Turbo's Pizza**, **Glenn's Donuts**, **Wheeler Flower Shop**, **Cross Car Center**

Those sponsoring the drawings but not giving tickets are: **First National Bank**, **Steve Emmert**, **Atty. Parkview Hospital**, **KPDR Radio Station**, **Dr. Mike Smith**, **Sparlin's Restaurant**, **Heritage Beef Cattle Company**, **General Telephone of the Southwest**, **Wheeler T.V. System**, **McCain's Auto Body**, **Maxey's Steakhouse**, **Speedi-Mart**, **Burton Ford**, **Honey Inn**, **Southwestern Public Service**, **Charles Kuntz**, **CPA.**, **Wright Funeral Home**, **Wheeler Gas Company** Division of **High Plains Natural Gas**, **Canadian Production Credit Association**, **Wheeler Vet Clinic**, **Wheeler Care Center**, **Wheeler Redi-Mix**, **Wheeler Times**, **Wheeler County Farm Bureau**, **Wheeler Feed Yard**, **Britt Ranch** and **H. & R. Block**.



A. Childress Is Special Olympics Poster Child

Amanda Childress has been selected as a calendar child for **Area 16 Special Olympics** located in Amarillo. She is the 10 year old daughter of **Wayne** and **Pat Childress** of Briscoe. Grandparents are **L. D. (Fat)** and **Wanda Childress**, **Briscoe**, and **Grady** and **Edith Brown** of **Sayre, Oklahoma**. Great grandparents are **Mrs. Addie Swift**, **Briscoe**, and the late **L. S.** and **Clara Childress**.

Amanda's parents took her to **Amarillo** November 24 for a photo session. Pictures were taken in a country setting. Her personal hairdresser was her cousin **Shelly Hunt**. Shelly will also appear in the photo for the calendar.

Eighty percent of the proceeds from the calendar sales will remain in the Panhandle to benefit local Special Olympics. Calendars should be available by the first of the year. Selling them will be **Pat Childress** and **Mrs. Claudia Marion**, Special Education Instructor at Wheeler Schools. Orders may be placed by calling **Pat** at home 375-2363 or at work **Wheeler Sheriff's Office** 826-5537. Mrs. Marion can be reached at home 826-5878 or Wheeler school at 826-5934.

Buckingham Named To Receive Silver Scholarship

Dean's Scholars of **Texas Tech University's College of Agricultural Sciences** were honored by faculty, administrator and parents at a reception Nov. 20 in the University Center Courtyard.

Each of the **Dean's Scholars** were awarded either a \$2,500 Gold Scholarship or a \$1,250 Silver Scholarship. The scholarships are renewable for up to four years if the program's requirements are met.

To be eligible for a Gold Scholarship each year, students receiving a Gold Scholarship must maintain a 3.4 grade point average; Silver Scholarship winners must maintain a 3.2 grade point average for a minimum of 30 credit hours.

Brent Buckingham, junior agricultural economics major from **Wheeler**, was a Silver Scholarship winner.

Meals On Wheels Report

The **Meals on Wheels** of Wheeler, Inc. are still delivering meals and we are approaching nine complete months of deliveries.

There will be a meeting of the **Meals on Wheels Board of Directors** on December 17, at 5:15 p.m. in the **Wheeler County Courtroom** to finish business

WEATHER

DATE	DAY	Lo	Hi	Pre
12-04	Wed.	28	58	0.00
12-05	Thurs	31	63	0.00
12-06	Fri.	32	69	0.00
12-07	Sat.	44	70	0.00
12-08	Sun.	49	64	0.00
12-09	Mon.	33	62	0.00
12-10	Tues.	37	64	0.00
Low for the year:		01-01,	13	
High for the year:		08-08,	101	
Total moisture for month:		0.00"		
Total for year:		21.21"		
Total Snow:		Trace		

Courtesy: KPDR-FM Radio

FIRST NATIONAL BANK

In Wheeler

WE WANT TO EXPRESS OUR APPRECIATION TO OUR CUSTOMERS AND FRIENDS FOR THE PAST YEARS. WE PERSONALLY WISH ALL OF YOU A VERY MERRY CHRISTMAS AND HAPPY HOLIDAY SEASON FROM EACH AND EVERYONE OF US.

Charles Brown
Van Baize
Mark Gill
Dan Kenney
Ann Henderson
Teresa Rose
Patti Wheeler

Stacy McQueen
Liz Shipp
Shari Porter
Bobbie Sue Baker
Brenda McWhorter
Cathy Harrison
Larry Saucier
And The Board of Directors



Pictured: (back row, l. to r.) Kristi Wheeler, Chad Harrison, Todd Baize, Brad Harrison, Marcy Rose, (third row) Creede McQueen, Vanessa Baize, Jeremy Kenney, Will Wheeler, Keith Rose, Matthew Gill, (second row) Gavin McQueen, Marcus Rose, Stacy McWhorter, Alan Gill, (front row) Katie Shipp, Savanna Shipp and Tina McWhorter.

We Will Close At 12:30
Christmas Eve
And Will Be Closed
Wednesday, Christmas Day

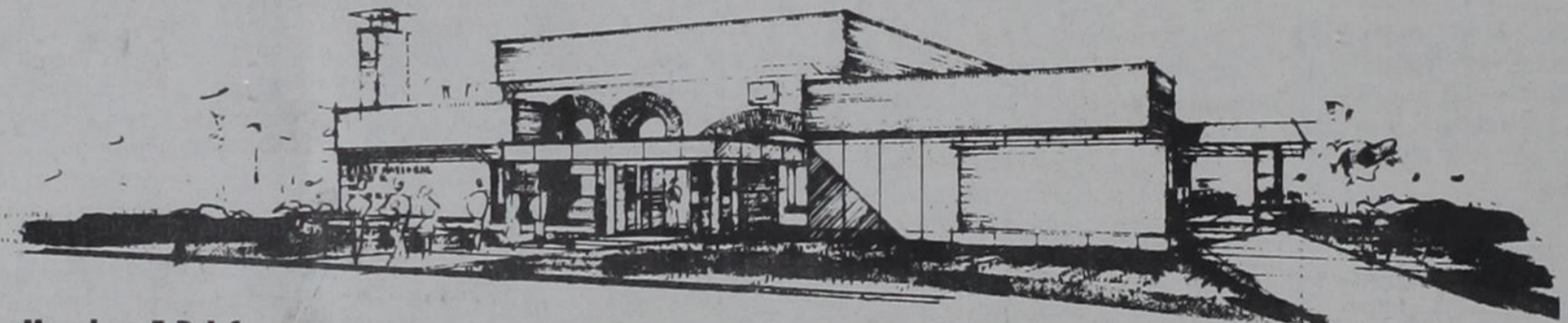

"Bank with the Best"

Member F.D.I.C.

SWEETWATER NEWS

By Mrs. Joe Flowers

For those who missed us last week, we spent ten days in the Community Hospital after Joe had a heart attack. He was in ICU three days. Sure met a lot of nice folks while there, but were so glad to get home. I don't drive much but only got honked at once. We thank everyone who helped us in our hour of trouble. I was amazed to learn how many we either knew personally or knew their parents. Oh, yes. David took care of Bertha Coffey while were gone? We sure did appreciate her taking him in.

Leroy, Peggy, and Darrin Dunlap have been to San Angelo to visit the Dale Dunlaps who have fine new boy named Jacob Zane.

Benny Pope has been sent to an OKC hospital. Ruth Wood is home. Ardie Able has had surgery. Floyd Otis is also a patient. Elec Atchley is a patient at Sayre.

Jackie North has opened a beauty salon three miles north, one west, and a fourth mile south of Sweetwater. Her husband Harvey has a garage where the Mong station was.

Word was received of the death of Hobdy Hodges in Porterville, CA. December 3. Burial was there.

Services were Nov. 26 for Martin Barnett at the Rose Chapel. He and

Goldie lived a number of years in this area. Burial was in the Buffalo Cemetery.

Services were recently at the Elk Creek Primitive Baptist Church for our friend Jim Stewart of Dill. Jim was born in our house many years ago before we bought this place.

Services were at the Martin Chapel for Pauline Stafford. She and Pete were our neighbors for years before moving to Erick. Burial was in the Buffalo Cemetery.

This is the 50th anniversary of Pearl Harbor. I remember the day well. I'd caught my gown tail afire and was seriously burned. Had to lay on my

TRALEE CRISIS CENTER

Brenda Wilkinson, Coordinator

FAMILY VIOLENCE & RAPE

Outreach/Victim Advocacy
Crisis Counseling:
1st & 3rd Thurs. each Month
Call for Appointment

Call: HOTLINE

1-800-658-2796

SHELTER & TRANSPORT

stomach with a wire frame holding the sheet off me with the radio my only entertainment when they came on with the story of the bombing. The years following were sad.

Indian Summer came by and cotton harvest is in full swing. Dean Carlson had first bale at Sweetwater.

The Erick Kitchen Band went to the Erick Home Tuesday and Bell Avenue Home on Friday without our Ole Five String. Band members during the week were Basil and Billy Doss, Iona Miller, Jack Criswell, Betty Brothers, Margaret Hiller, Hazel Francis, Rose Abila, Roy Swagger, Richard Crawford, Donna and Don Mercer, Bessie Perkins, Leonard Taylor, Raymond Snider, Murray Orgain.

We just about saw everyone in town the other day. Karla Paxton's parents from Mangum, Edna Moses, Roberta Smith, cousins Domer and Hazel Miller, of Allison, Flossie Thompson, George Nigh, Babe Frankford, Eldridge Calvert, Vera Teurman, Pat Wall, Henry Newman, Dill, Barney Jones, Canute.

Wilbur Nabors was out doing good deeds Friday. Fixed one stop and waste cut off and Bertha's storm door.

Leroy and Faye, Randy and Randilyn, Erick, Lanelle and Donniss Hayes, Don and Debby, Enid, Ricky Allen family of Hammon had Thanksgiving with Mildred Allen.

Wheeler Senior Citizen's December Meeting

The Wheeler Senior Citizens met in regular session on Monday night, December 2, at the Senior Citizen's meeting room on the south wing of the Library Building.

Twenty-one people met for food and fun. Willis Fillingim offered the opening prayer and blessing of the food. There were five persons having birthday in December and the Jack Hays were celebrating their 58th wedding celebration.

After eating our covered dish supper, a short business meeting was conducted, and then games were played for a couple of hours.

We all enjoy these meetings, and we invite all those who are sixty or over to come and enjoy our times together.

Those in attendance were Doris and Jack Hays, Eli and Helen Sabbe, Tom and Alice Bell Helton, Claudy and Ina Mae Brotherton, Willis and Lavern Fillingim, Birdie Hudson, Marie Gudgel, Nellie Horton, Sallie Harris, Mary Hudson, Hestell Killingsworth, Amelia Sims, Fannie Mae Bradstreet, Jewel Holloman, Loyd Davidson, and Elva Wood.

YARD WORK Needed: Snow Shoveling, Rototilling, Garden Spots Plowed. By the Hour or by the Job. 7 Days a Week. Danny Flanagan, 826-3653.

HYLAND'S PHARMACY

110 West Texas Street
Wheeler, Texas
Phone: 806/826-5561

REGISTER . . .

Once again we will hold a drawing for the "World's Largest Stocking". Our customers under 12 are urged to register.

We will also have a drawing for customers over 13. Remember the Chamber's 'Cash' Drawing Tickets.

Value-Rite Christmas Sale!

All 14 ct.
Gold Jewelry, Teen Rings
& Gold Nugget Rings

25% off

Flavor House®
3-PACK GIFT NUTS
Includes 3 tins of assorted nuts.

3.99

CASIO® MEN'S AND LADIES' WATCHES

Suggested Retail From \$12.95 to \$41.95

NOW

\$8.62 to \$27.94

33 1/3% OFF

galooob®
BABY FACE DOLL
13" tall doll. Each with her own special expression.
• With fully poseable head, arms & legs.
• Includes adorable, removable outfit.

17.88

YOUR CHOICE #6

CHRISTMAS CARDS #150
Regular retails from \$6.00-\$12.00

50% OFF
Sale Prices \$2.99-\$5.99

MAXEY'S STEAKHOUSE

SUNDAY BUFFET

- Salad Bar
- Pot Roast
- Smothered Pork Chops
- Whipped Potatoes
- Green Beans
- Fried Okra
- Baked Apples
- Hot Rolls
- Iced Tea/Coffee
- Dessert

THURSDAY NIGHTS

All the Fresh Water Catfish and Shrimp you can eat.
Served with Onion Rings, French Fries, Hush Puppies and Cole Slaw.

Sun.-Noon Buffet (Only) 11:30 a.m. -1:30
Tuesday-Saturday - 11:00 a.m. to 10:00 p.m.
• CLOSED MONDAY •

PHONE 826-3441

1 Mile South of Wheeler on U.S. 83

35 Christmas Light Set
STRONG LAMP DESIGN FOR EASY DECK MOUNTING

CHRISTMAS 35-LIGHT SET
Choose from clear or multi-color.

97¢

*Except for products excluded by law. Redeemable only at participating Valu-Rite® stores.

Here & There
By Laura Guthrie

It's a boy! Yes for sure. Jared Keith Forrester was born Dec. 6, 1991 to Curtis and Sherri Forrester of Carrollton, TX. The grandparents: the grandfather and the grandmother, are no other than Ed and Patricia Forrester. Handle with care? Oh, no. They are healthy and spry and proud. However they will have an early Christmas this year, in order to get acquainted with the little guy.

Mr. and Mrs. O. L. Forrester are the great grandparents of the new baby. Everybody is happy.

Didn't we all make Open House parties twice last Friday? At Lee's Hardware and Furniture there is a spaciousness that you can't imagine. And there is row after row of show cases and shelves filled with gleaming merchandise. It all looks so fresh that I'm wondering if they dumped their old stock and put in brand new stuff. Anyway, it is a store that could be proud in a city. It's a credit to Wheeler and to the family that has maintained it through the years.

The Post Office, due to space and its purpose was not so spacious but it bore dignity and generosity. The food was attractive and delicious. We appreciate this effort and friendliness. At the Post Office I met up with Tessie Clark and Audra Pierce, whom I rarely

see. Tessie is not well, but Audra seemed to feel fit. She was riding her three wheeler to get the exercise.

This same day, while I was out, I saw Cuba Mann. She is well as usual, but her husband, Burley, is not feeling so well. Their daughter LaJune Alexander is doing well after her hip surgery. The Mann family is like the rest of us. They can't get all the family together at the same time to celebrate the up coming Holiday. LaJune had the first of her family dinners last Sun. She and her husband Don, were hosts to their son, Russell and wife from Pampa, and her parents, Cuba and Burley Mann.

At the grocery store last week, I saw my neighbor, Ruth Taylor. She lives on my block but sorry to say we seldom see each other, we are both pretty well shut in. Ruth's sister Flora Garrison of Borger was with her. She had brought another sister, Sylvia Brown, back to Wheeler after a visit. Sylvia has not been well, so Flora had taken her to see a doctor. Still another sister of Ruth, Flora and Sylvia, was Rosalie Keelin of Briscoe I had a short visit with her. They are the daughters of the last Eula and Marvin Bradstreet.

Elva Wood spent Thanksgiving with her daughter Elizabeth Atchley and her family who live in Lefors.

On Tuesday following Thanksgiving Elva and Elizabeth went to Keene, TX to visit with Elva's aunt, Lurine Roper and the Billy Love family. Elizabeth attended a Fire Commission meeting

at Duncanville, TX. They returned home Wed. night.

Mr. and Mrs. Cliff Walker, Elva Wood of Wheeler and Merle Hunter of Pampa attended the Trailway Tourarama in Amarillo last Saturday.

Ben Karnes Students to Perform Sing-a-Long Christmas Carols at Shamrock First United Methodist Church

A sing-a-long of Christmas Carols will be presented by Ben Karnes' piano students Sunday, December 15th at four o'clock in the fellowship building of the First United Methodist Church

Shamrock.

"We are inviting our friends who like to sing the wonderful holiday songs and are making it special by including the boys from the Wheeler and Wellington class" said Karnes. "We appreciate the use of the miniature baby grand piano and believe it is unique in the state. We are also pleased that Toni Burke is playing a clarinet solo. Everyone is welcome."



Ain't It The Truth
By Ab Gunter

Won't be but a few days till the 50th anniversary of World War 2 and I understand that one of our Service Organizations want a public apology from the Japs. Maybe I'm stupid are maybe a quart low but how can we accept a So Solly Charlie sort of an apology from an enemy that did such atrocities to our own men and women and to all of the innocent people all over the western part of the world and the Orient. I had friends that were at Attu in the Alutician Islands conflict that were killed laying in hospital tents by Japs trying to improve on their bayonet practice and the survivors were mental cases when they got back home. I saw a pregnant native in the Philippines hanging in a tree with bamboo sticks pushed through her breast and native rope tied around the sticks and she was strung off the ground by these. Her hands were tied behind her and then her stomach was slit open and the unborn child was hanging there by its life cord. This lady was alive when all this torture was preformed. I dont like to be telling you about this and I'm sure you dont enjoy reading it but it happened. We got about a hundred of our prisoners through the Jap lines from the Dagami mountains at Leyte and on the way out we got to visit with some of them and saw their conditions and heard many things they had suffered but our visit was short as all of them were put in a compound with high barriers of

barriap around it. We were told it was to let them recover and to be briefed. I have many young friends that I had grown up with that were sent home to be buried and some that were never found that I loved and still miss and them there were others that were missing members and even their minds, all had given the supreme sacrifice and their loved ones are still mourning them.

On a hill at Okinawa that we had been kicked off of two or three times a buddy and I were on patrol and came across a soldier that had been gut shot and had tried to put on one of those large bandages made for such wounds, you could see he tried to fight off the enemy after being wounded by using his hands to defend himself. The enemy had sort of made a bayonet target of him by wounding him through the hands many times and through the chest and neck and even after death these Japs had boobytrapped this young man. Torture? You bet, them birds were professionals in such. My buddy and I marked the location by puttin this soldiers rifle in the mud by his head with a piece of rag so the bomb boys could get the boobytrap disconnected and removed his corpse.

I am sure that many many thousands of these type of horrible things could be told by your father, son, husband or loved one but even being there we could hardly believe it and certainly wouldn't expect anyone back home to believe human beings could do such an act. at Okinawa we accounted over a hundred thousand Japs but through the whole campaign did I ever see one of our men tortured one of the enemy.

From a country boys point of view it looks to me them birds are trying to take us over now without firing a shot and if some sort of plan dont come to pass we are just going to slip rite in their hands. Mama caught me lookin at each egg in a carton the other day at the Mall and she wanted to know what I wuz doin. I told her I wuz makin durr sure them durr chicken eggs come fum Indiana and not Tokyo, that wuz what I wuz doin.

See you next week, Buck Private Ab and Mama

WELCOME TO
FIRST UNITED METHODIST CHURCH
8TH AT MAIN - P. O. BOX 89 - WHEELER, TEXAS 79096
CHURCH (806) 826-3114 - PARSONAGE (806) 826-3079

Weldon Rives, Pastor	Sunday School	9:45 a.m.
	Morning Worship	11:00 a.m.
	Evening Worship	6:00 p.m.

"Fast Friendly Service"
PEARSON AGENCY
GERMANIA INSURANCE COMPANIES
Rita Pearson Agent
Mini Mall—N. Hwy 83—Wheeler
No Reassessment
Compare Our Rates

- * Auto
- * Home
- * Commerical
- * Farm
- * Ranch
- * Mobile Home

826-3740

THRIFTWAY
SUPERMARKET 300 EAST OKLA. WHEELER, TEXAS

DOUBLE COUPONS
7 DAYS A WEEK

MAKE *CHRISTMAS* SHOPPING EASIER THIS YEAR...
GIVE A **GIFT CERTIFICATE** FROM **THRIFTWAY**. We have **BEEF CERTIFICATES** or **Gro.-Cert.** (Any Amount)

REGISTER TO WIN...
Lots of Prizes!
ALSO... GROCERIES
This SATURDAY AT 4 P.M. we will be giving away **\$100.00** worth of Groceries!

Last Week's Winners...
Sammye Rives - Bear
Yreva Shirey - Mini Walkman
Katherine Holt - Iron

HEAVY GRAIN FED BEEF
Boneless Chuck Roast **\$1.69** LB.

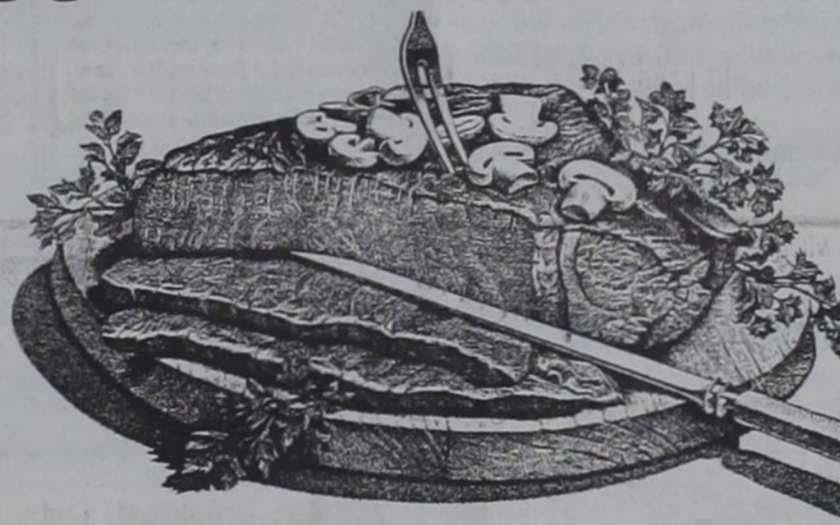

Christmas Savings



ASSORTED
Banquet Dinners
9-11 OZ. BOX
89¢



ALL TYPES
Coca-Cola
2 LITER BTL.
99¢



PILLSBURY ALL READY
Pie Crust 15 OZ. BOX
\$1.49



PILLSBURY PLUS OR LOVIN' LITES
Frosting 16 OZ. CAN **\$1.19**
PILLSBURY PLUS OR LOVIN' LITES
Cake Mixes 18 OZ. BOX **59¢**



24 LGE./36 MED. ELASTIC LEG
Fitti Diapers CONV. PKG.
\$4.79



EVAPORATED REG. OR LIGHT
Pet Milk 12 OZ. CANS
2 \$1



MINUTE MAID ASSD. FROZEN
Orange Juice 10-12 OZ. CAN
99¢

FmHA Purposes Ethanol Fuel For Environment

In an effort to reduce pollution by decreasing gasoline and diesel fuel consumption, the Farmers Home Administration (FmHA) has been requested by Edward Madigan, Secretary of the United States Department of Agriculture (USDA), to remind all employees to procure ethanol-derived fuels when such fuels are available at comparable prices with regular gasoline.

Ethanol is a grain-derived alcohol which burns cleaner than regular gasoline, reducing exhaust pollutants. Existing vehicles may use ethanol or ethanol-blended fuel without harm to engines or need for retrofitting. By implementing this alternative fuel policy, the USDA is seeking to reduce American dependence on oil, and improve the quality of the environment.

Beginning on April 17, 1991, the President signed an Executive Order on Federal Energy Management which encourages the use of alternative fuel sources such as Ethanol. This order mandates that USDA cut its gasoline and diesel fuel consumption by 10 percent between Fiscal Year 1991 and Fiscal year 1995.

Prior to that, the Secretary had issued a memorandum in 1990 mandating that USDA employees purchase ethanol or ethanol-blended, oxygenated fuels (ETBE) when using USDA-owned or leased highway vehicles.

Under these two guidelines, credit will be given to agencies utilizing alternative fuels towards the mandated reduction. Accordingly, Secretary Madigan has requested that USDA employees operating vehicles procure ethanol or ETBE-blended fuels when available at prices comparable to unleaded gasoline. He has also asked that drivers approach service stations in their areas that offer ethanol fuel yet do not accept the U.S. Government National Credit Card to determine if they would be interested in being added to a Defense Fuel Supply Center Contract in order to accept this card.

Any service stations interested in this environmental policy may call Louise Stoneburger at (703) 274-7417 to request a packet, or write to: Defense Fuel Supply Center, DISC-PEB, Attention: Louise Stoneburger, Cameron Station, Room 8-C186, Alexandria, Virginia 22304-6160.

Festival Of Lights
Dec. 14, At Childress

Residents of all ages will participate in "Home Town Christmas—Festival of Lights" 6 to 8:30 p.m., Saturday, Dec. 14, in Downtown Childress—from the courthouse to the underpass, down Commerce and Main Streets.

It's a walking tour of the Christmas lights and decorations of downtown Childress. There'll be carolers at the site of the historic Engine 501, in Armstrong Park on the corner of Avenue A and Main Street.

Along the lighted pathways will be booths and displays by fund-raising organizations.

The invitation is open to any and all organizations from Childress and the surrounding area to host a fund-raising booth. Those interested may call Reba Wakefield at 817-937-66231; June Lott, 817-937-2002; or Anne Carter, 817-937-2579.

Santa, himself, has marked the calendar for the special walk. He'll be greeting and listening.

Local artists are preparing Christmas scenes for the Courthouse lawn. Stores and offices will be decorated for the occasion. Musical entertainment will be at First Bank and Trust on Main Street.

Stores will be open until 8:30 p.m. for those who wish to browse and shop for Christmas.

Those who participate in the Festival of Lights Walk may park anywhere and begin their walk.

HOUSE PAINTING & LIGHT CARPENTRY, ROOFING, PLUMBING & ELECTRICAL

SPRAYED ON ACOUSTICAL TYPE CEILINGS

DONALD FORD
806/826-3106

L. & F. Repair

110 W. Okla. St.
Zenith & R.C.A. TV's
Frank E. Coates, Owner

34 YEARS EXPERIENCE
...in TV Repair
P.O. Box 220
Wheeler, Texas 79096

Phone:
806/826-3241

Listen to...
KPDR-FM, 90.5
Wheeler, Texas

Come Visit...
The Stitch & Chatter Shop
(Next Door to the SPS Office)

Select group **Fabric 45" to 60"** wide inc. Christmas 1/2 price reg. price 3.98 to 7.98
One group **Lace 5 yds \$2.00**
One group **Buttons 10 cards for \$1.00**
Small Mops for Dolls
Reg. 2.98 — **\$2.00 Sale**
Pre-made Mop Heads
Reg. 69c & 79c now **49c & 59c**

Free Grab Bag with **\$15.00** purchase. Values to \$25.00

We're also the **Bus Station and Laundry and Dry Cleaning Pickup Station.**

MOST IMPORTANT: We're always ready to help you whether with a sewing problem or picking out fabric and notions.

Open through the Noon Hour, Also!
Call **Mary Risner** at **826-3608**

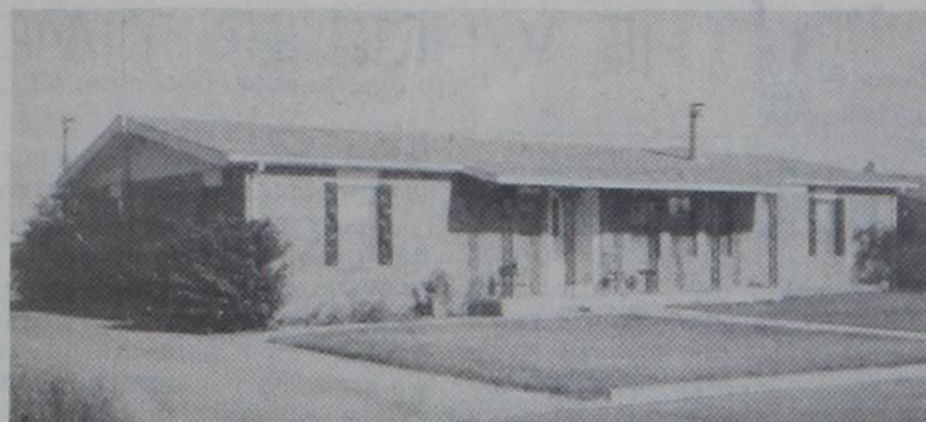

#113 Three bedroom, two bath brick home with fireplace and double garage.
1314 S. Canadian St.

#108 Large three bedroom, 2 bath home with one fireplace and one wood stove, two living areas, an office, cellar & double garage. Owners have been transferred
510 S. Reynolds

#112 Large two or three bedroom country home with fire place and cellar on 20 acres close to town. Perfect for Texas Veterans' Land Board Financing.

#100 Three bedroom, 1 3/4 bath brick home with fireplace, double garage, fenced yard on paving.
Mobeetie Street

#56 Two bedroom, one bath home with siding, cellar, large lot, and carport.
1134 S. Main

#101 Three bedroom, two bath brick home with storm windows. Fenced yard with storage building and cellar.
514 Osage

#126 Three bedroom, 1 3/4 bath stucco home with fireplace, basement, cellar and workshop on 1.7 acres east of Wheeler.

#66 Two bedroom, one bath stucco home with garage and apartment on corner lot. Owner will finance!
708 S. Alan L. Bean Blvd.

#114 Two bedroom, one bath home with single car garage. Assume FmHA loan. Low Move-in Cost.
406 W. 12th

#122 Three bedroom, two bath rock home with fireplace and attached garage on extra large lot.
1207 S. Alan L. Bean Blvd.

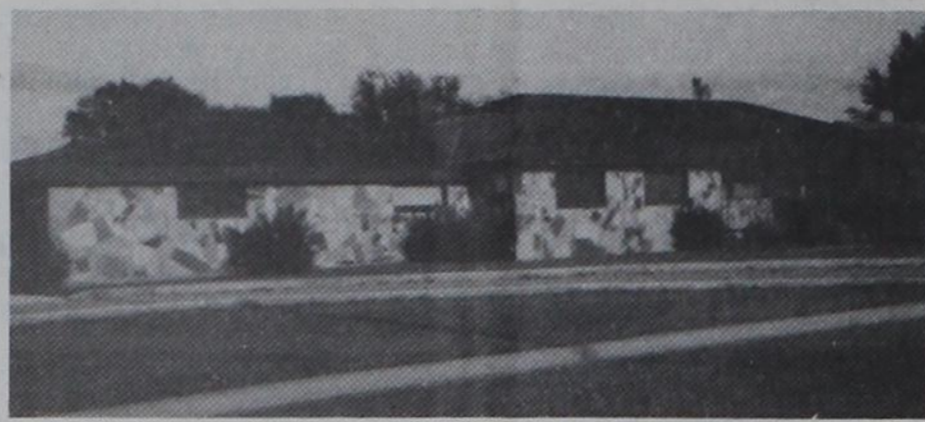

#122 Three bedroom, two bath rock home with fireplace and attached garage on extra large lot.
1207 S. Alan L. Bean Blvd.

#58 Large four bedroom, two bath home with two fireplaces, large lot, double garage.
512 S. Reynolds

#59 Three bedroom, 1 3/4 bath stucco home with cellar and carport.
1100 S. Mobeetie

#78 Two bedroom, one bath stucco home with garage.
508 Kiowa

#94 Two bedroom, one bath stucco home with garage on corner lot. Owner will finance!
800 S. Sweetwater

#105 Four bedroom, two bath country home with fireplace, cellar & carport on 2+ acres.
East of Wheeler

#77 Two bedroom, one bath frame home with basement & Central air. Owner will finance!
601 S. Canadian

#103 Two bedroom, two bath mobile home.
102 S. Bryan St.

#113 Three bedroom, two bath brick home with fireplace and double garage.
1314 S. Canadian St.

#123 Let the Mobile home park help make your payments. Three bedroom, one bath stucco home with garage and cellar on 1+ acres with three rented mobile homes and one trailer space (also rented)
1101 S. Stanley

COMMERCIAL BUILDINGS:
Amwest Building

LOTS: #99 By the School. \$5,000
#110 Vacant lot on south end of Alan L. Bean Blvd.



#112 Large two or three bedroom country home with fire place and cellar on 20 acres close to town. Perfect for Texas Veterans' Land Board Financing.

FOR SALE: RANCH Wheeler County call for Appointment!

ACREAGES
#120 21 acres with seep pond, older three bedroom frame home with storm cellar.
East Edge of Wheeler

#121 20 acres of grass with rent house and barn.
South Edge of Wheeler

In The Country:
#125 Immaculate two bedroom, one bath stucco home with remodeled kitchen on two acres. Eight miles east of Wheeler. Owner will trade for house in town.

MOBEETIE
#96 Two bedroom, one bath (remodeled) on large lot in Old Town.

APPRAISALS



the smith agency

GREG AND RUTH SMITH
806/826-5541 or 806/826-3238

Joe & Betty Lee 375-2381
Lavon Williams 826-5803

Jim Hill 826-3094
Lona Williams 826-3341

112 E. Texas Street, Wheeler, TX 79096
RUTH SMITH, BROKER

Want Ads

HELP CLEAN YOUR SEPTIC TANK THE EASY WAY with FX bacteria. \$9.98. Tree Roots removed. Drains opened. Ask for FREE BOOKET. Wheeler Lumber Company, Wheeler, Texas.

REAL ESTATE APPRAISAL & SALES
Farm & Ranch Land Specialist
Laven Williams
THE SMITH AGENCY
826-5541 826-5803

WANTED USED CHRISTMAS TREES: For use as habitat for fish. To have picked up call Bob McCain, 826-3433 or deliver to McCain's Auto Body Shop.

FOR SALE: Lap afghans. Contact Gladys Kysar at Wheeler Care Center.

DEMOCRAT
For Commissioner, Pct. 1: Elmer Ray Harrison
For District Clerk: Dale Helton
Patti McNeil-Guthrie
For Tax Assessor/Collector: Jerry Dan Helley
For County Sheriff: Jimmy Adams
Dennis Hilburn
Art Taylor
James D. Garner
REPUBLICAN
For Commissioner, Pct. 1: Paul Hathaway
Vote in the March 11 Primary

REMODELING CONSTRUCTION CONCRETE PATIOS REDWOOD DECKS PAMPA POOL & SPA Waterbed warehouse DAVID BONNER PAMPA
665-4218 or 665-6064

FOR SALE: 2290 Case tractor, 3000 hrs. on complete rear end and transmission overhaul, excellent condition. 20-8 4300 Massey Drill, good box several new disk and ready for use. Good 12 year old kid barrel horse. 2 registered Limousin bulls, papers available. Call 405-243-8346 or 405-534-2392.

FOR SALE BY OWNER: 701 S. Main, 2 bedroom, 1 bath, dining and utility room, central heat and air, garage and double carport, cellar, privacy fence. Asking \$27,500.00. 903/532-6061.

FOR SALE: 1984 Mustang, 4 cycle, 68,000 actual miles, \$2,000. Clay Walsler. 826-5683.

MUST SELL: 1979 Customized Chevy Van. Call: 826-3701 or 826-3528.

FOR SALE: 1988 G.E. Refrigerator, works, call 826-3356.

William Appliance Service
For Appliance Service
Call 1-800-241-9644

For all your Painting, remodeling and wall paper hanging, acoustic ceiling & wall texturing call RAY AND SHERRY HUNTER, 665-3111. We have local references.

IF YOU BY HEALTH INSURANCE, you could be paying too much. Specializing in Major Medical and Medi-Care Supplements. CONTACT: Kenneth McCasland 826-3573 or 826-3036.

SEASONED OAK FIREWOOD FOR SALE: \$125 per cord delivered. Other woods available. 826-5754, or 826-3702 after 5:00.

NOTICE TO PUBLIC
Any erroneous reflection upon the character, standing or reputation of any person, firm or corporation, which may appear in the columns of this paper will be gladly corrected upon due notice being given to the editor personally at the office at 110 East Texas St., Wheeler, Texas.
Postmaster: Send address changes to "The Wheeler Times", P.O. Box 1080, Wheeler, Texas 79096-1080. The Wheeler Times does not knowingly accept false or fraudulent advertising or other advertising of an objectionable nature, is printed in full confidence in the presentation made. Readers will confer a favor if they will promptly report any failure on the part of the advertiser to make good any misrepresentation in our advertisements.

PECANS FOR SALE: Fresh new crop paper shelled pecans, cracked or in shell. Will crack your pecans over night. L & F Repair, 826-3241, Wheeler, TX.

FOR SALE: 28 x 64 Graham doublewide, \$18,400, OBO. Call 826-5701.

Shamrock Laundry
Open 24 Hour
7 Days a Week
Corner of 4th & Madden St.
Shamrock, Texas

THE WHEELER TIMES
Page 4—Thursday, December 12, 1991

FOR RENT: 3 BR, 2 bath home on Mobeetie Street. Call 806/826-3563 or after 5 826-3260

BASEBALL CARD SHOW: 1st show in Shamrock at Mitchell Family Restaurant, Dec. 14, 9-5.

NEED: 2 baby beds with mattresses. Call 256-5112.

FOR SALE: 2 bedroom house in Shamrock, corner lot and cellar, 901 N. Wall, \$10,000. Call 405/983-2213, Durham, OK.

FOR SALE: Just in time for Christmas 4-piece sectional like new, chrome and glass curio shelf like new, solid oak entertainment center, great condition. Call 826-5902.

Work Needed: Snow Shoveling and/or house cleaning. 826-3653.

MEMBER 1991
TEXAS PRESS ASSOCIATION

THE WHEELER TIMES
P.O. Box 1080
Phone: 826-3123
Entered as second-class matter December 18, 1933, at the Post Office at Wheeler, Texas 79096, under the act March 3, 1879.

Louis C. Stas, Owner and Publisher
SUBSCRIPTION RATES:
Wheeler County . . . \$15.00
Outside County . . . \$16.50

THE BUSINESS DIRECTORY

Royal Alliance Associates, Inc.
Member NASD/SIPC
David Zybach, Securities Broker
1-800-999-9352
Stock-Bonds-Mutual Funds-C.D.'s
Insurance-Retirement Plans-Tax Free Investments

AA MEETING
Alcoholics Anonymous meets at 8:00 p.m. in the Wheeler Masonic Lodge on Thursday of each week.

CHEVRON CROSS CENTER
GUARANTEED AUTO GLASS INSTALLATION & BODY REPAIR
PHONE: 826-5515
WHEELER, TEXAS

WHEELER LUMBER CO.
Phone 826-5543 Wheeler, TX
Fine Service for Fine People

FARM BUREAU TEXAS
TEXAS FARM BUREAU
Insurance Companies
Gary Alston
Agency Manager
Agents:
Gary Ware
Wayne Wheeler

Wheeler Lodge No. 1099
A.F. & A.M.
MONDAY
7:30 P.M.
Russell Galbraith, Wm. Jim Lawless, Secy.
Box 675
Members Urged To Attend.
Visitors Welcome

WHEELER REDI-MIX
REDI-MIX CONCRETE SAND
Washed Gravel
All Sizes
Office Hours: 7:30 to 5
Phone: 806/826-3223

REGIONAL MENU

Dec. 16-20, 1991
MONDAY: Breakfast: Cereal, toast, juice, milk.
Lunch: Corn dogs, cheese sticks, salad, brownies, milk.
TUESDAY: Breakfast: Oats, toast, juice, milk.
Lunch: Stew, cheese sticks, crackers & cornbread, fruit milk.
WEDNESDAY: Breakfast: Biscuits, peanut butter, juice, milk.
Lunch: Turkey and dressing, cream potatoes, gravy, green beans, hot rolls,

pecan pie, milk.
THURSDAY: Breakfast: Bacon and eggs, sausage & biscuits, toast & jelly, juice, milk.
Lunch: Nachos, corn, salad, brownies, milk.
FRIDAY: Breakfast: Sweet rolls, juice, milk.
Lunch: Sandwiches, tator tots, potato chips, baked beans, fruit, milk.

CARD OF THANKS
We wish to thank the Fire Departments for promptly distinguishing the grass fire on our farm recently.
Kirk Kite
Margaret Kite Martin

Shamrock Greenhouse & Floral
4500 N. Main Shamrock 256-2616 or 256-2344
Living Christmas Trees
(Mondale Pine)
Plantation Fir — Cut
1-800-551-0571

Happy 18th, Big D
May all your dreams come true.
We are so proud of you!
Mom, D. & L.

Information Needed For 911 Service

The information will remain strictly confidential. It will only be used when responding to a 9-1-1 emergency call. The following should be considered before completing and returning the form:
1. If you have a telephone located elsewhere than just your business or residence, note this in the COMMENTS section. If it is a different number and within the vicinity of your residence, list that number also.
2. When giving directions from the nearest city, rural residents should give the highway number and begin routing directions from the city limits marker on that highway. If bad weather frequently causes the normal route to be impassable, include an alternate route.
3. In the COMMENTS section, list any circumstances or situations that would be helpful in responding to an emergency, such as health problems, guard dogs, locked gate, flammable material, etc.

any circumstances or situations that would be helpful in responding to an emergency, such as health problems, guard dogs, locked gate, flammable material, etc.
4. If you wish, include relative or friend to contact in an emergency situation, including name, address and telephone number in the COMMENTS section.
Mail the completed form(s) to:
Panhandle Regional 9-1-1 Network
P.O. Box 9257
Amarillo, Texas 79105
Additional information may be obtained by contacting your local law enforcement agency or by calling the Panhandle Regional Planning Commission at (806) 372-3381.
9-1-1 Service will be available in the Wheeler, Kelton, Allison, Briscoe and Mobeetie exchanges in January 1992.

(Related Story Page 2) **9-1-1 INFORMATION FORM**

Please complete the following questionnaire for each telephone number.

Telephone Number: _____ Class of Service: _____
(Business, Residence, Mobile, Coin)

Name: _____

Mailing Address: _____

City: _____ County: _____

Location (Rural residents should give directions from nearest city using exiting highway intersections as landmarks): _____

Comments (Provide any information emergency personnel should know about the location, such as health problems, guard dog, locked gate, etc.): _____

TexSCAN
Statewide Classified Advertising Network
Advertise in 291 Texas newspapers for \$250.
Reach more than 3 MILLION Texans.
Call this newspaper for details.

HAPPY JACK TRIVERMICIDE: Recognized safe & effective by Center for Veterinary Medicine against hook, round & tapeworms in dogs & cats. Available O-T-C at farmer co-ops & better feed stores.
DEER HUNTERS SPECIAL: 25 acres, \$795/acre, wooded, excellent hunting, adjoins large ranch. Texas veteran or owner financing, prime acreage. Fox Realty, 500 Buchanan Dr., BURNET, TX 1-800-725-3699.
COVENANT TRANSPORT: Hiring tractor trailer drivers. *1 yr. O.T.R. experience *Single 19-22¢ *East coast pay *Incentive pay *Benefits package *Minimum age 23 *Teams 27-31¢ 1-800-441-4394.
BUY-SELL-TRADE-ANYTHING With the American Trading Club. Free information. No obligation. *Call 24 hours. 1-800-233-9053.
WOLFF TANNING BEDS: New commercial-home units from \$199. Lamps, lotions, accessories. Monthly payments low as \$18. Call today. FREE NEW color catalog. 1-800-228-6292.
FIRST CLASS MACHINIST: Engine lathe, horizon-

tal boring mill, and CNC lathe. Benefits: group insurance, retirement, profit sharing, Mark's Machine Co., Inc., El Campo. 409-543-9204.
DRIVERS: KLLM INC., Dallas and Houston terminals are now hiring experienced tractor trailer drivers to run 48 states and Canada! Call 1-800-925-5556, Monday-Friday.
RANCH SUPPLIES OR FARM EQUIPMENT: Steel buildings!! Distressed inventory! Very limited quantities. Example: 40X56 was \$7,884 now \$5,987; 40X116 was \$13,635 now \$9,870; 50X200 was \$25,741 now \$18,871. 303-757-3107.
ARE YOU TIRED OF COLLECTING monthly payments on your contract or deed of trust? We'll give you cash now! Call American Equity Funding, Inc. today. 1-800-874-2389.
ADOPTION: ACCOUNTANT & BABY nurse would love to adopt your newborn, would provide warmth, security & wonderful education. Legal/Confidential. Call Regina/Jeff 1-800-831-9246. It is illegal to be paid for anything beyond legal or medical expenses.

Wheeler County & District COURT RECORDS

List of instruments filed in Wheeler County Clerks office for the week of November 27 thru December 5, 1991

NOVEMBER 27, 1991
A OF JUDG—Signal Fuels Co. to Steve Lamb 11-26-91

OL—State of Texas to Marathon Oil Company 10-1-91 Sec 27 Blk OS-2

OL—State of Texas to Marathon Oil Company 10-1-91 Sec 26-A Blk OS-2

D—Gloria Danette Blakemore to Richard Dale Blakemore 11-25-91 Lots 15 & 16 Blk 63 Woodley's Southside Add. Shamrock

DT—Richard Dale Blakemore to Gloria Danette Blakemore 11-25-91 Lots 15 & 16 Blk 63 Woodley's Southside Add. Shamrock

D—Tommie Virginia Clay et al to Tim Reynolds 11-1-91 All Lot 1 & N 40' of Lot 2 Blk 15 Orig Town Shamrock

DT—Tim Reynolds to Tommie Virginia Clay et al 11-1-91 All Lot 1 & N 40' of Lot 2 Blk 15 Orig Town Shamrock

NOVEMBER 28 & 29, 1991

Holiday
DECEMBER 2, 1991

MD—Holly Jackson Smyth et vir to John W. Pride et al 10-23-91 Sec 47 Blk 24 Sec 9 Blk RE

MD—Moneita B. Clements to John W. Pride, et al 10-28-91 Sec 47 Blk 24 Sec 9 Blk RE

AOL—1985 Seville Ardsley, L.P. et al to Pan Petroleum MLP 11-26-91 Sec 29 Blk A-3

EXT DT—David H. Gilmer, Jr. et ux to Security State Bank Cheyenne, Oklahoma 11-22-91 10 acs. NW Pt NE/4 Sec 6 Blk RE

C/C PROBATE—George A. Moberly to Ex Parte 10-23-91

R FED TAX LIEN—United States of America to Larry C. Barbour 11-22-91

R FED TAX LIEN—United States of America to Larry C. Barbour 11-22-91

AFF HEIRSHIP—Dorothy Ann Kinney to Evan L. Sitter 11-29-91

TRUSTEES D—Harriet O. Morrison et al to George N. Otey, III et al 2-18-91 N/2 Sec 32 Blk A-4

C/C PROB—Samuel R. Bird, aka Samuel Richard Bird to Ex Parte 1-5-88

D—N. L. Sechrist et ux to Richard N. Sechrist et al 11-29-91 5 acs. NW/4; SW/4 exc. 7 1/2 acs. NE cor SW/4 Sec 9 Blk A-4

TDT—Texas Independent Bank to Fleet National Bank 11-12-91 Lots 9 & 10 Blk 25 Orig Town Shamrock

D—James M. Horton et ux to Al E. Caviness et ux 11-21-91 Lots 6 - 8 Blk

18 Mobeetie
D—Cecil O. Snelgrooves et ux to Ramon Perez Silva et al 12-1-91 100'x150' SE cor SW/4 Sec 5 Blk A-4
DT—Ramon Perez Silva et al to Cecil O. Snelgrooves et ux 12-1-91

ENERCEPT, INC. OIL AND GAS PROFESSIONALS

EXPERT REVENUE RECOVERY
AUDIT ROYALTY PAYMENTS
VERIFY VALUES
VERIFY PRODUCTION
VERIFY PAYMENT DECIMALS
IDENTIFY MISSING REVENUE
FOLLOWUP AND COLLECTION

EXCELLENT REFERENCES

CALL TOLL FREE
1 (800) 658-7168

JOHN McNAB OR JODI NORD

100'x150' SE cor SW/4 Sec 5 Blk A-4
D—Elsie Irene Cox Hughes to Francis Bryan Pride et ux 11-29-91 SE/4 Sec 11 Blk A-3

DT—Francis Bryan Pride et ux to Elsie Irene Cox Hughes 11-29-91 SE/4 Sec 11 Blk A-3

RESOLUTION—Briscoe Home Demonstration Club to L. D. Childress et al 11-20-91 Lots 11 & 12 Blk 1 Briscoe

D—Briscoe Home Demonstration Club to L. D. Childress et ux 11-20-91 Lots 11 & 12 Blk 1 Briscoe

MD—Briscoe Home Demonstration Club to Travis Keelin et ux 11-20-91 Lots 11 & 12 Blk 1 Briscoe

PART D—Jerry P. Reid et al to Jerry P. Reid et al 11-15-91 See Instrument

DECEMBER 3, 1991

AFF—City of Wheeler to Mike Hobbs 12-2-91 E/2 N 53 1/3 acs. W/2 Sec 5 Blk A-4

RDT—First Bank & Trust to Kenneth Stowe et ux 12-2-91 See Instrument

RDT—The Royal Bank and Trust Company to Page Petroleum, Inc. 11-7-91 See Instrument

DECEMBER 4, 1991

Happy Birthday Dec. 12 to Debbie Hammer, Lindsey Fillingim and Melba Corcoran on Dec. 12 to Greg Estes, Doyle Grimes, Novelene Simpson, Jenny Smith, Joshua Purcell, Bryan Light on Dec. 14 to Georgia Corse, Bobby Greenwood, Kerri Hudson and Melody Goad. On Dec. 15 to Shanna Leatherman. On Dec. 16 to Jeff Corcoran, Jim Hamilton, Mary Ruth Morris, Mearlene Scott, Geneva Corcoran. On Dec. 17 to Bill Howard, Sheryl Estes, Jeremy Gudgel, Holly Hodges, Heather Hodges, and Chad Hefner. On Dec. 18 to Mary Hudson, Bob Brittenham and Missy Barr.

Happy Anniversary on Dec. 14 to Jap and Alice Bailey. On Dec. 16 to Bill and Virginia Ridgway and Vernon and Grace Moore. On Dec. 17 to Bill and Lean James.

Our sympathy goes out to the family of Doris Newsom. Her bright smile will be missed in Mobeetie on Fridays.

Our sympathy goes out to the family of Lynn Ford.

The Mobeetie Fire Dept. Calendars are on sale. They can be bought at Moore Grocery Store, Harrison Beauty Shop and at the cafe.

Visiting last Sunday with Laverne Scribner was Bill and Dutch Elliott of Pampa.

Lorene Rector and Orville Greenhouse shopped in Pampa Wed.

Christopher Simmons and Tyler Burchof Wheeler visited Wed. evening with Dale and Melba Corcoran and Jud and Lorene Rector.

Pauline Barnes of Wheeler took Verna Corcoran to Pampa on business Mon.

William Burch, Christopher and Tyler of Wheeler visited Friday with Jud Rector.

Remember the City Council and School Board meets Thurs.

Bob Brittenham of Tulsa, OK., Trish Brittenham of Sayre, OK. visited friends and tended to business over the weekend. It was good to see Bob.

Jap and Alice Bailey shopped in Wheeler Wed.

Cam Klose and Anna Bell Corcoran attended the Arts and Crafts show in Amarillo at the home of Kay Simpson. Anna Bell suffered a fall down the stairs. She is recovering at home.

Doyle and Bulah Grimes were happy to report the birth of their great grandson. He was born Dec. 6 and weighed 5# 6 ozs. His parents are Aaron and Dixie Floyd of Wichita, Kans. Dixie is the daughter of Jerry and Phyllis Tucker of Lamar, CO. Bulah didn't know what they named the baby as they hadn't named him Friday.

J.P. and Martha Meek of Briscoe visited Doyle and Bulah Grimes following XYZ. They played 42.

Leslie Harrison of Elk City and Gene Harrison went on a fishing trip over the weekend to Lake Fork.

Claude Laverty is home following his discharge from the Army.

Willene Burke has been helping out her parents Mr. and Mrs. J.T. Baker in Reydon, OK. Her mother has been in the hospital.

Visiting over Thanksgiving with Clifford and Euline Walser was her two brothers Mr. and Mrs. Joe Ed Sherrod of Dallas, Mr. and Mrs. Bob Sherrod of McLean and Joe Billy Sherrod of Amarillo, Jean Roper and Ted Quillen of Pampa, Mr. and Mrs. Ronnie Brown and Kasey of Kellerville and Mr. and Mrs. Don Brown, Tatum and Clint of Wheeler.

Christopher Simmons and Tyler Burch visited Mon. with Melba and Dale Corcoran and Jud and Lorene Rector.

Clifford and Euline Walser went to Amarillo Friday Christmas shopping. Lovella Hollingsworth and Betty Brown of Amarillo visited Leona Williams Thurs.

Sue Mayfield and Leona Williams shopped Mon. in Pampa.

Visiting Pierce and Nettie Walker Sat. afternoon was her sister Betty and James Schaub of Pampa.

Aline Corse took Pierce and Nettie Walker to Amarillo for Nettie's eye treatment.

Bernice Hefley and Eunice Carter went to Amarillo Mon. and will stay all week while Eunice is taking treatments.

Lonnie Trout of Miami visited his mother Ella Trout Sunday.

Marilyn Howard of Laketon and Justin Holman of Miami visited Ella Trout on Monday.

Bernice Hefley and Eunice Carter visited Mollie Selby, Jimmy and Laura Fern Selby on Thurs.

James and Alisha Moffett and John attended the Arts and Crafts show Sunday at M.K. Brown Aud. in Pampa. Billy and Shelia Touchstone had a booth in the show.

Torin House of Las Vegas and Chris and Tiffany House of Pampa visited

Beltone 50 years
CELEBRATING THE SOUNDS OF LIFE

CRAIG SMITH

Authorized Dispenser
Beltone Hearing Aids

Next Wheeler Service Center January 23
Batteries & Service for All Brands

6040 SW 33rd St. Free Hearing Test
Amarillo, Texas 79106 1-800-766-45134

Family TV Sales & Service

26 Years Experience in TV Repair

Monday thru Fri. 8:30 to 5:30

VCR & Microwave Oven Service

-- No Job too Small --

-- No Trip Charge to Wheeler --

111 N. Main Shamrock, TX 256-2369

Furniture and Fixtures For Sale

Quitting Business

Hurry Before The Best Items Are Sold

MONDAY 12-9-91 Everything 50% Off

TUESDAY 12-10-91 Everything 55% Off

WEDNESDAY 12-11-91 Everything 60% Off

THURSDAY 12-12-91 Everything 65% Off

FRIDAY 12-13-91 Everything 70% Off

SATURDAY 12-14-91 Everything 75% Off



★ Coupon ★

Bring in this Coupon for 50,000 points in our prize contest. Limit one per customer per day.



Rheams Diamond Shop
939 S. 2ND - HWY. 60-83 SOUTH - CANADIAN, TX 79014
Phone: 323-8922

Sale Terms:

Cash-Check
VISA-M/C
Amex-Discover

Sale Hours:

Mon.-Fri.
9:30-5:30
Sat.
9:30-4:30

Every Item Must Be Sold



THE WHEELER TIMES

Page 5—Thursday, December 12, 1991
"Wheeler, town of friendship and pride."

AOL—Bruce Keeler to Reneau Oil Co. 12-3-91 See Instrument
ASSIGN—Upland Resources, Inc. to John W. Goehring 11-15-91 See Instrument
DECEMBER 4, 1991
DVL—Fred McCray to Dean Tipps et ux 11-19-91 SE/4 Sec 79 Blk M-1 NE/4 Sec 2 Camp County School Lands

several days with Ralph and Leona House.

Alvern and Dorsie Hutchison of Wheeler visited Sunday with Orville Greenhouse.

Bobby Galmor of Shamrock visited Orville Greenhouse Monday.

Earl Tabor is in High Plains Baptist Hospital in Amarillo. We hope he is soon home.

William and Patricia Burch, Christopher and Tyler of Wheeler visited Sunday with Dale and Melba Corcoran.

Dale and Melba Corcoran visited Sat. night in Wheeler with Earl and Pauline Barnes.

Lorene Rector visited Monday in Wheeler with Marvin Piece.

We were glad Mr. R. St. John is home from the hospital and able to be out and about.

The First Baptist Church will hold

DISTRICT CLERK'S FILINGS

#9538—Cindy Lou Walker vs James Clifton Walker, Jr., 11-27-91, Divorce

#9539—Rachel Alvarado vs Santiago Alvarado, Jr., 12-2-91, Divorce

#9540—Ken William Blanchard vs Boyd Kennedy, Estate, 12-3-91, Damages-Motor Vehicle

their annual Christmas Card exchange Sunday night now. There will be a supper of sandwiches, chips and dips and a white Christmas. They will be bringing can goods to pack six boxes for needy families for Christmas. The Christmas program will start at 6:30 with the card exchange and supper to follow the services. There will be no Training Union that night.

Visiting Monday with Mrs. Laverne Scribner was Vern and Susie Lohberger and Susana of Briscoe and Allison.

Mt. View Quilting Club
The Mt. View Quilting Club met Dec. 5 at the Totty School House. Eva Webb served refreshments of chips and fresh vegetable dip. The emergency quilt wasn't finished. Those present were Estelle Hodges, Audrey Seitz, Eva Webb, Bulah Grimes, and Flora Mae Kelley.

ACE Hardware

INCREDIBLE BARGAINS

8⁸⁸

WHILE SUPPLIES LAST

ACE Hardware

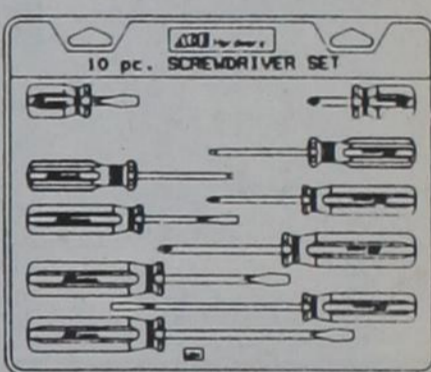

10-Pc. Screwdriver Set

Includes the most popular Phillips and slotted screwdrivers. Perfect addition for any tool box. 27981

3⁶⁶

WHILE SUPPLIES LAST

ACE Hardware



Ultra Brute AA Flashlight

Tough to withstand water, harsh weather, even impact! Super bright Krypton bulb. Batteries included. 34412

17⁸⁸

WHILE SUPPLIES LAST

MAGNAVOX

Smart. Very smart.



AM/FM Stereo Cassette Player

Personal stereo comes with light weight stereo headphones and belt clip. 63084

9⁹⁹

WHILE SUPPLIES LAST

Chicago Cutlery

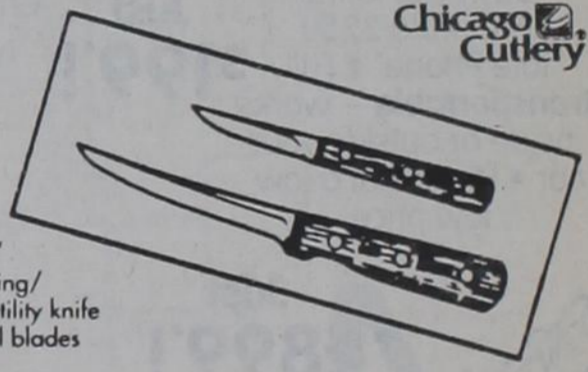

Gourmet Sampler

Gift boxed set includes 3" paring/boning knife and 5" boning/utility knife with high carbon stainless steel blades and walnut handles. 67630

LEE Hardware & Furniture
420 S. Main—826-5532—Wheeler

VARIABLE RATE LOANS

9.50%

RURAL REAL ESTATE
AND
RURAL RESIDENCE

- LONG-TERM FINANCING UP TO 35 YEARS
- NO PREPAYMENT PENALTY
- ONE POINT CLOSING FEE
- FUNDS HELD ACCOUNTS AVAILABLE
- FIXED RATE LOAN PLANS AVAILABLE

FEDERAL

Offices Located Throughout the State

LAND BANK ASSOCIATIONS
IN TEXAS



FOR MORE INFORMATION PLEASE CONTACT:
The Federal Land Bank Association of Childress
P.O. Box 910—Childress, Texas 79201

*Annual percentage rates are 9.61% in 9.89% depending on length of contract. Variable rates are subject to change.

817/937-6181

Listen to . . .

KPDR-FM, 90.5

Wheeler, Texas

Isaiah 55—6 & 7:
Seek ye the Lord while He may be found, call ye upon Him while He is near: Let the wicked forsake his way, and the unrighteous man his thoughts, and let him return unto the Lord, and he will have mercy upon him; and to

Dr. Jack L. Rose
OPTOMETRIST
121 Main St. -- Shamrock
Phone: 256-3203
Tues.: 9-5 Fri.: 2-5

our God, for He will abundantly pardon. The Allison Community was saddened to hear of the sudden death of Doris Newsom last Saturday morning. Our prayers and sympathy is for her children and their families and other relatives and her many friends. Doris was a good woman and will be missed. Tanner McWhorter spent last Friday night with his Me-Ma Ruby Craig. Ruby and Wilma Gilmer and Tanner went to Pampa last Saturday where they did some shopping and visited at the home of Lisa and Calvin Farmer, Ryan and Matthew.

A bright sun shiny Monday morning here in Allison, December so far has been mostly nice and warm. Last Wednesday Hiram and Dorenda Begert were in Amarillo working at the Farm and Ranch Show. They also were in Canyon and attended

the Festival of Lights at the W.T. Campus with their son Bret. Juanita Boydston and Cheryl Dupont were in Pampa last Tuesday for music. Forest Boydston spent a few days last week at San Sabe, Texas deer hunting. Janice Boydston was visiting her sister Mary Wolf at Midland over the weekend. Roma and Billy Brown spent a couple

of days the first part of this week for business reasons and visited Warren and Charlene Brown. Peggy Chandler, Melvin and Betty Stinnett's last Sunday afternoon guests were Mary Nell Finsterwald and April from Briscoe and Dave Gilmer. Peggy, Jennie Walker and Betty Stinnett took Gertie Cornell out to eat at Sparlin's last Thursday. Jennie, Betty and Peggy



visited Gertie Sunday afternoon at the Care Center, Melvin and Betty and Jennie visited last Saturday morning with Dave Gilmer.

Red and Anna Dukes took Bessie Crenshaw of Shamrock and her sister to Amarillo where they went by plane to California last Monday. On their way to Amarillo they stopped in Panhandle and visited at the school for Special Education Class for children up to five years old. Red's daughter Adeline Hays is one of the teachers at the school. Adeline asked her Dad, Red to play the harmonica and the fiddle for the children. They enjoyed that. Red and Anna, Bessie and her sister also had lunch with Adeline and the children at the school cafeteria. Red saw two different doctors while in Amarillo. Last Wednesday Red and Anna attended the funeral of Red's aunt Mike Moore of Antelope, Texas.

Henry and Cheryl Dupont, Sabrina and Cody's last Sunday dinner guests was Ona Black.

Glen and Nona Elmore's visitors after church last Sunday night were Wayne and Kathy Zybach, Clay and Casey, Nelda Dukes visited with them Sunday evening awhile and Hoyle Helton visited after church Sunday morning for awhile.

(Marginal Note) The only thing faster than the speed of light is word of mouth.

Recently Pete and Margaret Gilmer, Becky and Jeannie Gilmer of Amarillo spent ten days through the Thanksgiving holidays with Keith and Ann Boydston, Natalie and Jessica at LaBelle, Texas and with Rodney and Linda Ingersoll and Andrew of Louisiana. Pete and Margaret were in Amarillo last weekend shopping and spent Friday night with Becky and Jeannie.

Cletus Greene and Mabel Parker was in Amarillo last Tuesday doing some shopping.

Bruce and Pearl Harrison spent last Thursday night at Elk City with Vivian Wallace. Last Wednesday night Ronnie Wallace from Sweetwater, OK, and Cheryl Dupont, Sabrina and Cody were supper guests with Bruce and Pearl and helped put up their Christmas tree. Vivian spent Sunday night and Monday with the Harrisons.

Effie Hays house guest for a few days has been her sister Virginia Remling from Amarillo.

Alan and Sheryl Lane, Laurie, Jimmy Alan and J.W. went to Pampa last Saturday for the boys to see and visit with Santa Claus.

Bob and Virginia Puryear's guests recently were Charley and Tammy Puryear, Jessica and Jake from Las Vegas, New Mexico and Andy Puryear and Ryan from Kennewick, Washington. Bob and Virginia attended the Farm and Ranch Show at Amarillo last Tuesday and Wednesday.

Norvita Robertson from Dalhart is here spending some time with Lanora Morse.

(Marginal Note) If you can remain calm in the midst of chaos, you've obviously had some experience raising a family.

WMU

The Mobeetie WMU met Tues. at the First Baptist Church for their "week of Prayer for Foreign Missionary" program. Carol McCurley brought the program about 8 different Foreign missionaries around the world. It was a very interesting program. Those attending were Edith Cross, Orville Greenhouse, Bulah Grimes, Ruth Hathaway, Carol McCurley, and Lorene Rector. Following the meeting they enjoyed a salad lunch at noon. Their guests were Rev. Ralph and Mary Hovey, Kelley Cross and Doyle Grimes.

Listen to...
KPDR-FM, 90.5
Wheeler, Texas

B & B ELECTRIC
Appliance repair on all makes and models.
Authorized service on Sears, Whirlpool & Maytag.
No Mileage or Trip Charge.
In Wheeler on Thursdays!
—25 Years Experience—
Lloyd Bybee, Owner
Call McLean Collect
779-3252

Dobson Cellular Systems Presents

The 12 Ways of Christmas

A Dozen Reasons Why Christmas Time is the Right Time for a Cellular Phone and Service.

1 Our Lowest Price!
Say hello to the Motorola 2250 "Tote Phone" • Fully transportable -- works inside or outside your car • Hi-tech at a low, low price!
Just **\$199!**

Give the gift that 'receives' -- the Nokia C12-TM! • Hands-free operation • 60 phone number memory with speed dialing • Christmas comes calling for less!
2 A 'Ring' for Christmas!

Just **\$349!**
3 The Affordable Portable!
The Nokia P4000...the get-up-and-go-anywhere phone! • Portable works in your car as well as it works in your hand • AC charger • 40 phone number memory • Last number re-dial.

4 Just \$899!
Big Performance, Small Package!
You'll flip for the "Flip" Portable from Motorola! • Light weight (12 oz.) and compact, mouthpiece flips up to fit in your shirt pocket! • 30 number memory • Super speed dialing • Top-of-the-line features, performance and convenience from a top manufacturer!

5 Roam on the Range!
With extensive roaming privileges in over 800 U.S. cities, plus the exclusive Follow Me Roaming™ feature, Dobson is everywhere you need to be.

6 Lay-A-Way 'til Christmas Day!
Found what you want? Convenient lay-a-way until December 25th is available with only 10% down!**

7 Convenient Lease Options!
Leasing is smart! Dobson has lease options starting as low as just \$15 a month!

8 Convenience!
Now it's easy to have a phone in you car, truck -- even your pocket -- that goes everywhere you go. You're never out of touch with Dobson!

9 Coverage!
Only Dobson gives you one, unified coverage area between Oklahoma City and Amarillo, and our coverage is expanding this month to include Lela, Conway and Farnsworth. Plus, roaming privileges allow you to use your phone in over 800 U.S. cities.

10 Customer Service!
No matter what your question, there's a friendly and helpful Dobson customer service representative as close as your cellular phone.

11 FREE Long Distance!
We've eliminated long distance fees on the calls you place from inside the Dobson coverage area to any phone number in your home area code!

12 The Dobson Reputation . . .
For over 50 years, Dobson has set the standard in communications excellence through superior service, technical innovation and customer satisfaction.

Whether it's for someone on your Christmas list, or just for yourself, give the gift that keeps on giving all year long: an affordable cellular phone and service from Dobson Cellular Systems. Happy Holidays!

DOBSON CELLULAR SYSTEMS
1-800-882-4154

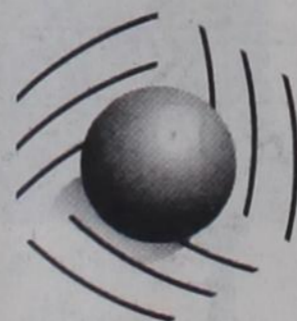

*Prices advertised available at all Dobson Cellular Systems' stores and from participating Dobson Authorized Agents while supplies last. Certain terms and conditions apply. ** Subject to credit approval.

BARRY PRICE CELLULAR
256-2072

PANHANDLE COMMUNICATIONS
256-5364

JERRY'S RADIO SERVICE
256-3405

Wheeler Church of Christ

Congregational Concerns:
On this coming Sunday afternoon, December 15th, this congregation will conduct a devotional at the Wheeler Care Center. This devotional will be begin at 3:00 P.M.

Congratulations must be expressed to Paul and Kim Franklin upon the birth of their daughter, Taylor Nicole Franklin. she was born on Sunday, December 8th weighing 7 lbs and 4 ozs. The proud grandparents are Kelly and Gail Newman. And the proud great grandmother is Doodie Phillips.

Congratulations must be expressed to Curtis and Sherri Forrester upon the birth of their son, Jared Keith Forrester. He was born on Friday, December 6th, weighing 7 lbs and 4.5 ozs. The proud grandparents are Ed and Patricia Forrester. and the proud great grandparents are Otto and Esther Forrester.

Thomas Daughtry is hospitalized in St. Anthony's Hospital in Amarillo. His condition is extremely serious. Earl Tabor is hospitalized in High Plains Hospital in Amarillo, recovering from surgery. His condition is slowly improving.

Eunice Carter is taking radiation treatments in Amarillo. These treatments will last two weeks. Clark and Vergia Reagan will leave the last of this week to go to Odessa to be with their daughter who is critically ill.

From The Minister's Desk:

In the 1987 baseball season, Paul Molitor, the third baseman of the Milwaukee Brewers, achieved baseball history. he had a thirty-nine game hitting streak which was the fifth longest hitting streak in baseball history. But when Molitor's hitting streak ended on August 26th, 1987 in a game with the Cleveland Indians, the reactions of the fans of the Brewers was bizarre.

At the end of nine innings the game was tied and Molitor had gone hitless. But in the bottom of the tenth inning with Molitor on deck, Rick Manning hit a single, driving in the winning run for the Brewers. While Manning's single won the game, it also denied Molitor the opportunity to extend his hitting streak, and the Brewer's fan booted! These fans forgot that winning was the purpose of the game. They were so engrossed with the trivia of the game that they forgot its purpose.

The fans of the Milwaukee Brewers are not the first people to make this mistake. There are many parents who make the same mistake. These parents become so engrossed with the trivia in the lives of their children that they forget about the important issues of life. For example, —

They seek the best secular education for their children. But in the pursuit of this education, these parents forget to teach their children a faith in God, and such a faith is the most important issue of life.

They seek desperately for their children to be popular. But these parents forget to teach their children to have a character of love, honor, and integrity. Popularity is a poor substitute for such a character.

They emphasize the athletic accomplishments of their children, but these parents forget to emphasize the worth of their children as people. These parents need to have the attitude that John McKay had when his son was a star player on his football team at the University of Southern California. When Coach McKay was asked about his pride in his son's football accomplishments,

he gave an impressive answer, saying: "Yes, I'm pleased that John had a good season last year. he does a fine job and I am proud of him. But I would be just as proud if he had never played the game at all." Coach McKay recognized and appreciated his son's athletic accomplishments, but his love and approval for him did not depend upon them. More parents need to have the attitude of Coach McKay, recognizing that athletic accomplishments are trivia when compared to the worth of their children as people.

Parents are not the only ones who become engrossed with trivia. Churches can make the same mistake. These churches are statistically-oriented, emphasizing mainly attendance and budget statistics. And because of this emphasis, the members of these churches are often anxious, resentful, and impatient people.

Yet the Bible teaches that the basic priority of the church is the development of a Christ-like character in its members. The Apostle Paul wrote: "—We are to grow up in all into Him, who is the head, even Christ, from whom the whole body, being fitted and held together by that which every joint supplies, according to the proper working of each individual part, causes the growth of the body for the building up of itself in love." (Ephesians 4:15-16) Like parents, churches can become engrossed with trivia, forgetting to develop a Christ-like character in their members.

On August 26, 1987, Paul Molitor's thirty-nine game hitting streak ended. When it ended, Milwaukee Brewers fans should have learned an important lesson. This lesson was: "Do not be engrossed by trivia. A hitting streak is not the purpose of a baseball game. Focus on its purpose."

Parents and churches would be wise to learn the same lesson.

Bill Morrison, Minister
Church of Christ
Wheeler, Texas

An Invitation: You are cordially invited to attend any of the weekly services of the Wheeler Church of Christ which meets at 1001 S. Alan Bean Blvd. in Wheeler, Texas.

Services:
Sunday Bible Study 10:00 A.M.
Sunday Morning Worship 11:00 A.M.
Sunday Night Worship 6:00 P.M.
Wednesday Bible Study 7:30 P.M.

BRISCOE NEWS

By Vetola Parker

We are having good crop gathering weather, that sun is bright. T.V. said 24 degrees up north and that is not chill factor.

One night when Nelson was working in Dubia Oman he called me said they had landed up there in New York. He didn't have a coat it was, 32 chill factor wind blowing like mad. Do you think I slept rest of the night? Garry says he keeps that coat, stocking leg cap and gloves in his car and close, warm one day cold next day, in Dumas. We are having big dews.

Still counting 5 kittens never see old mother. Cat mice and rats are hiding out.

It was 135 degrees in Dubia when

MOBEETIE MENU

Dec. 9-13
MONDAY: Breakfast: Buttered toast, choice of cereal, juice, milk.
Lunch: Taco, corn of the cob, French fries, peaches, chips, milk, tea.
TUESDAY: Breakfast: Hot biscuits, sausage-bacon w/gravy, jelly, butter, juice, milk.
Lunch: Chicken and noodles, green beans, carrot and celery sticks, crackers, milk, tea.
WEDNESDAY: Breakfast: Cinnamon toast, hot cereal, fruit, milk, juice.
Lunch: Turkey & dressing, green beans, sweet potatoes, apple sauce cake, hot rolls w/butter, milk, tea.
THURSDAY: Breakfast: Hot biscuits, eggs, fried ham, juice, milk.
Lunch: Vegetable stew, garden salad, grill cheese sandwich, fruit, milk, tea.
FRIDAY: Breakfast: Pancakes, syrup & butter, sausage, bacon, juice, milk.
Lunch: Hamburgers, French fries w/ catsup, lettuce, tomatoes, pickles, onions, ice cream, milk, tea.
 Menu subject to change.

XYZ Club Met
 The Mobeetie XYZ Club met Dec. 6 at the First Baptist Church for their Christmas party. They sang Christmas songs and the room was decorated with Christmas theme. Everyone enjoyed the good covered dish supper. The Dec. Birthdays were Irene Webb, Martha Meek, and Doyle Grimes. Edith and Kelley Cross made miniature Christmas mail boxes with candy for all attending. Those attending were Marion and Ethel Grimes, Rev. Ralph and Mary Hovey, J.P. and Martha Meek, Doyle and Bulah Grimes, Kelley and Edith Cross, Chuck and Louise Hogan, Willis and Verna Fillingim, Laverne Scribner, R. St. John, Orville Greenhouse, Austin Caldwell, Irene Webb and Ruth Hathaway.

he left there, didn't realize, how cold here it could get.

Mable came over for a visit Wednesday morning she looked good. She brought me some pecans, they were large and real good tasting, just needed some good teeth, many thanks to Bill and Neta.

Wind blew all night, looks like another

WHEELER PLUMBING

511 S. Cheyenne

New Construction
Remodel
Repair
Sewer Service

Phone: 826-5907
FREE ESTIMATES
MAX McQUEEN
P.O. Box 754 Wheeler, TX

nice day at 7 a.m. not many clouds Wednesday.

Thursday I had been reading about fire ants, they are coming this way by the month. A cousin in Denton wrote asked me if we had the fire ants. Her husband was spending most of his time killing fire ants. I didn't know if they were calling the red ant the fire ant. I read in a farm paper the fire ants builds a mound over the dirt they attack vegetables most okra, cucumbers, corn, small birds, newly born calves, most anything small and tender. I sure don't want them, or the killer bees around.

Talked to Eunice Edwards she almost had pneumonia last week. She went to Dr. got her some medicine. She was washing what she didn't need to be doing. She said Darv. and Sammie got home. They came by Andy and Troices they were there Thanksgiving. Mickey and Little Mike are still at Darvs. They have Angels little girl. Eunice was better.

Cecil and Mary Edwards has been up visiting Eunice they are from Ft. Worth.

Ted and Pauline came last night around 9 p.m. was sure glad to see them. Was about out insulin, cotton

and chewing gum ha. they looked pretty good. Don't know what I am going to do, Garry is off on Sunday and Monday now.

Marie was at Essies, they were fair, didn't have any visitors, Mona and Don had gone home.

Mattie was fairly this Saturday morning. Sitting in a chair by her phone reading. Was doing fair think she said. They all went to Alice and E.O.'s for Thanksgiving.

Bettie and Frank Wood and grandbaby Tiffany Hunter came down. lolene's great grand.

Belinda called lolene said they were coming in 2 or 3 weeks to see them.

Edith Levitt called me a little while ago that Doris Newsom dropped dead last nite started to go to bed. She was found this morning Saturday, sure hate to hear this such a shock this way.

Jane and Chris a neighbors grandchild came up for her mail, Sunday afternoon.

Still rather pretty Sunday.

Monday morning sure quite.

Marylou said Bob seemed better. He may get to get out hospital soon. Mr. Warren is in hospital in Shamrock. Don't know if its George or Will. I just know its Glady's Dad and Ellas Fishes granddad.

Doris Newsom was our notary, she will be missed. Our sympathy goes out to her 3 children, Vivian and Dorothy and Leslie.

Mae Welch went to her funeral, Mae said she sure looked pretty like she use to look. She was buried up here at Zybach cemetery by her mother she said. It was quite a shock, I know, Edith Donaldson and Edna May were her sisters.

They were Richersons before marriages.

Mae said they had dinner at church house and supper.

Little Billy was in hospital Saturday night North West Texas I think. A bunch beat him up. Don't see why a kid would go to Amarillo, Dumas is bad enough, gang, about a year ago, all of Garry's were in bed asleep a knock on door, Tish went to door a boy said they wanted to talk to Billy she woke Billy told him he was wanted



THE WHEELER TIMES

Page 7—Thursday, December 12, 1991

Wheeler, town of friendship and pride.

outside, Billy went out, they had a shovel, they lit in on him. Tish woke Garry, Garry went out took the shovel away from them told them now one at a time take Billy, they ran. W.O.W. Garry brought the shovel in house, kept it. W.O.W. What is the world coming to?

Tish's granddad is George Warren, he is still holding on, in Shamrock hospital. Jennifer and James Dad brought them to see Tish from Ne-

braska they were with her, from Wednesday to Sunday. He took them home, his mother lives in Dumas. April's mother does also, April is his wife now.

Listen to...
KPDR-FM, 90.5
Wheeler, Texas

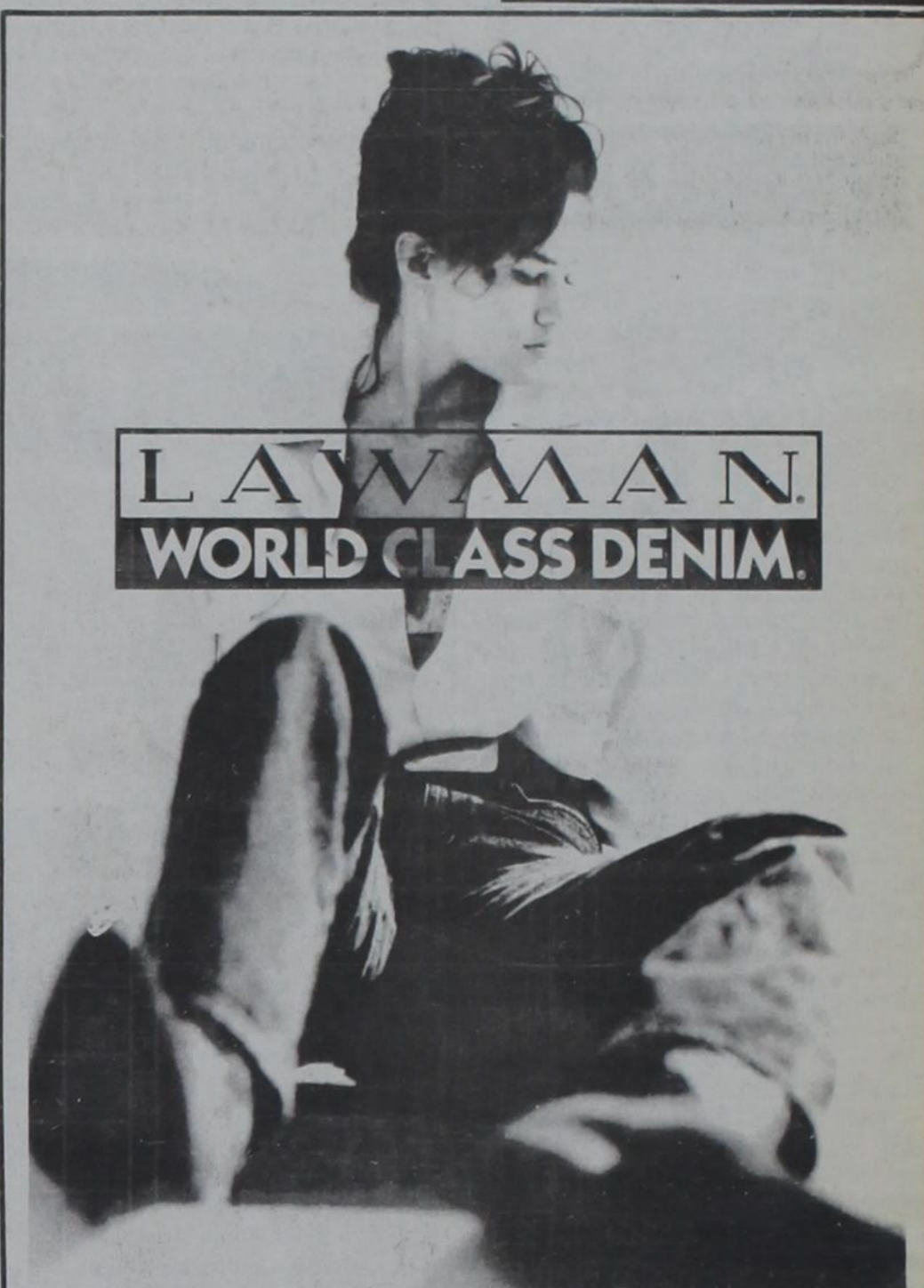

LAWMAN WORLD CLASS DENIM.

Lawman JEANS 20% Off
 (This Week)
Andie's Appropriate Apparel
 Open 8:30 — 5:30 Monday thru Saturday Visa, Mastercard
 "On the Square in Wheeler" Welcome
 410 S. Main Wheeler, Texas 79096

* Bookkeeping * Payroll Services * Tax Reports
 * Farm & Ranch * Individual * Corporate
 Partnership - Fiduciary
Professional Services
Joseph G. Dickey
CERTIFIED PUBLIC ACCOUNTANT
 420 W. Florida — P.O. Box 1677 — Pampa, Texas
 806/665-2336
 "Please Call For Appointment"

WILD HEARTS CAN'T BE BROKEN
 Drama
 Starring: Michael Schoeffling, Cliff Robertson
Rated G
 New Show Time
 Fri. thru Thurs.: 7:30 P.m.
 Local Ph.: 497-3415
 Toll Free: 1-800-542-3932
 Admission \$2.50
 6 & Under Free with Parents
 SHOW DATES: Dec. 13-19
ROOK THEATRE
 Cheyenne, Oklahoma

FREE ESTIMATES 24 HR. WRECKER SERVICE
McCAIN'S AUTO BODY
 117 W. OKLAHOMA - BOX 65 - WHEELER, TX 79096
 PH. 806/826-3433
 INSURANCE CLAIMS OWNER: BOB McCAIN

** PUBLIC NOTICE OF VOTING PRECINCT CHANGES **

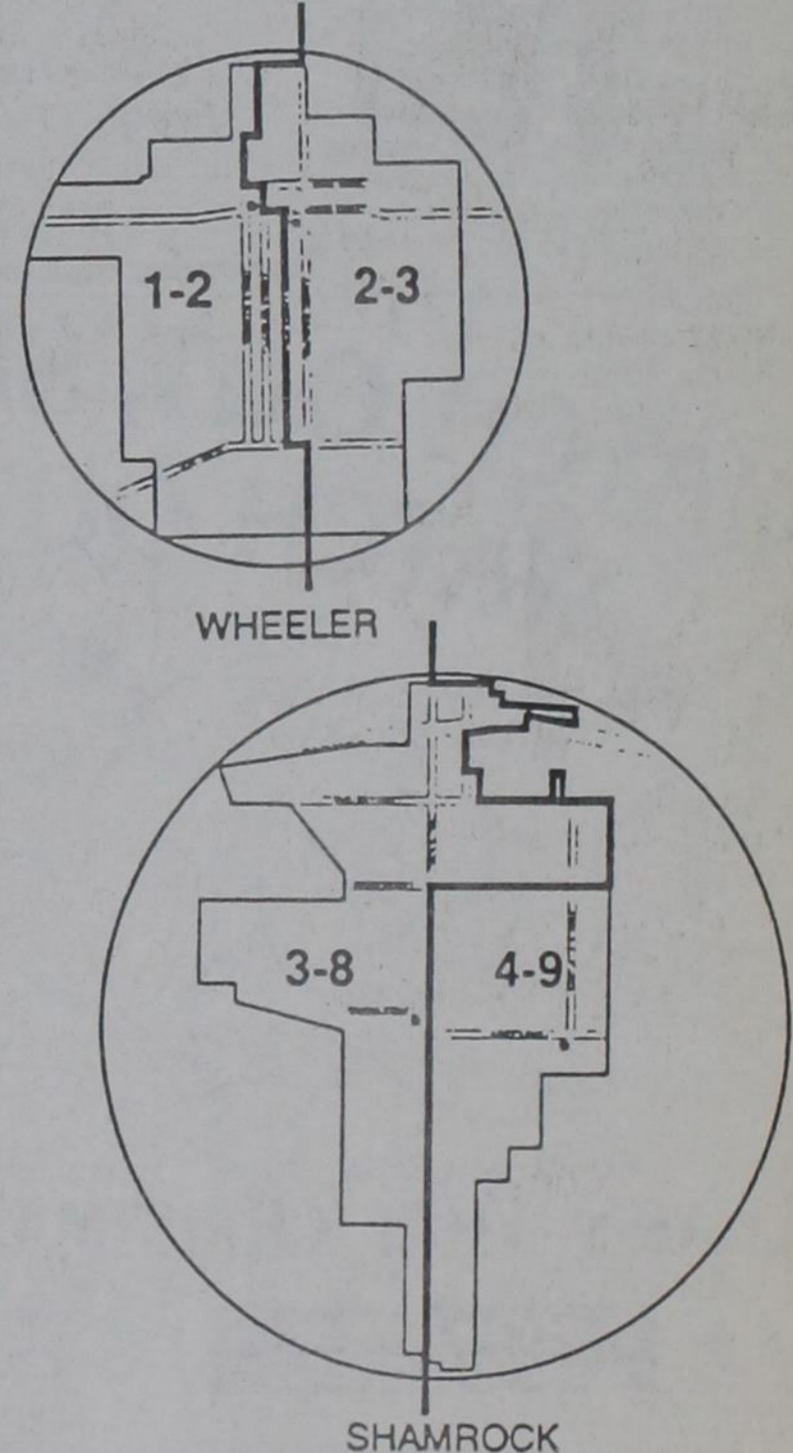
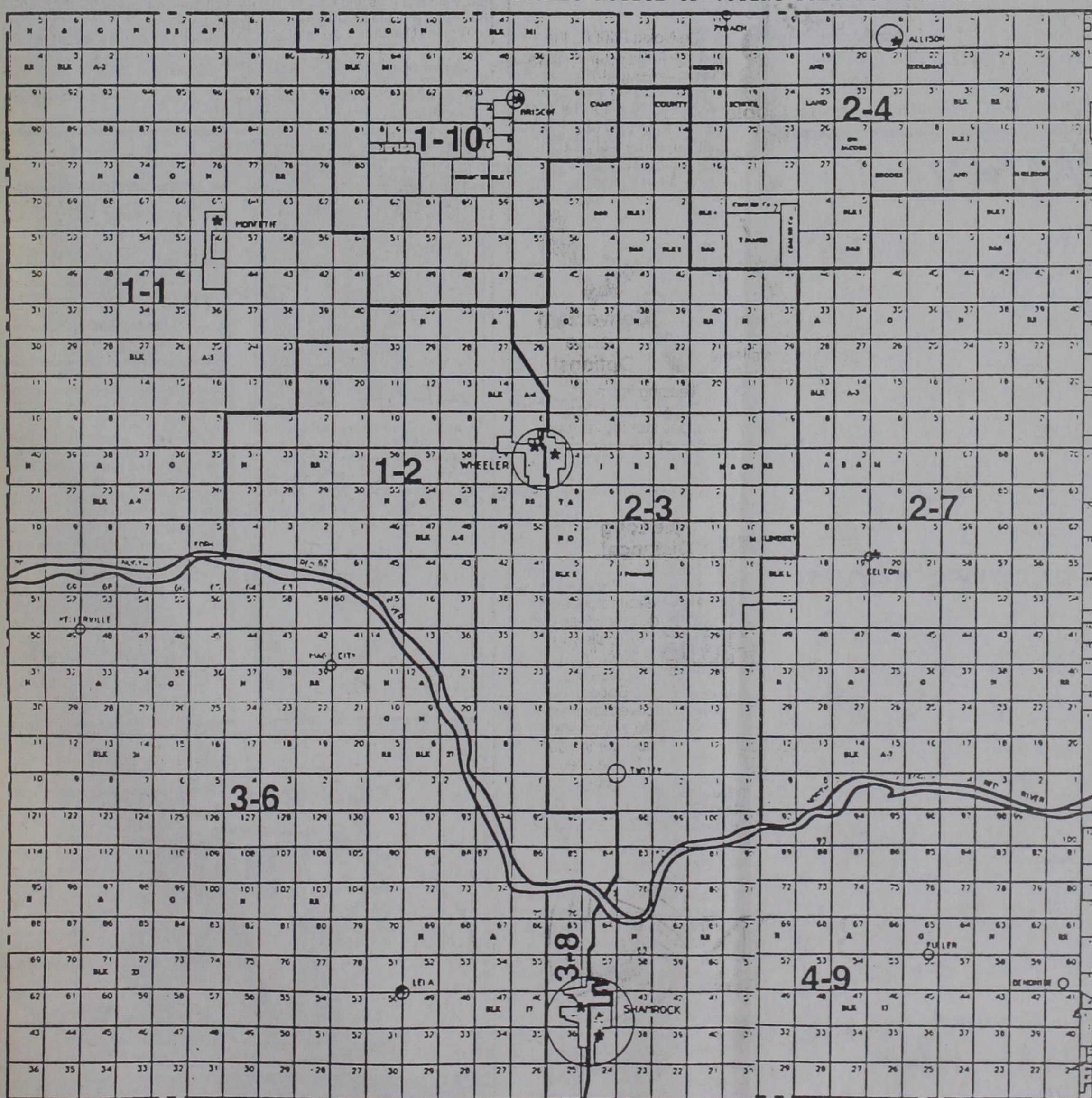

WHEELER COUNTY
 ELECTION PRECINCTS
 ADOPTED BY COMMISSIONERS COURT
 SEPTEMBER 9, 1991, SUBJECT TO
 PRECLEARANCE BY U.S. DEPARTMENT
 OF JUSTICE.

- PCT. 1-1 MOBEETIE
- PCT. 1-2 WHEELER
- PCT. 2-3 WHEELER (STANLEY)
- PCT. 2-4 ALLISON
- PCT. 3-6 LELA
- PCT. 2-7 KELTON
- PCT. 3-8 SHAMROCK (WEST)
- PCT. 4-9 SHAMROCK (EAST)
- PCT. 1-10 BRISCOE

WHEELER COUNTY VOTING PRECINCTS

• indicates Voting Center

SCALE 1 MILE



EFFECTIVE DATE: January 2, 1992

Happy Birthday to Stacey Phillis, Karen Meek, Amy Meadows and Nellie Horton on December 15, Amy Huff on Dec. 16, Chad Hefner on Dec. 17, Ma Mary Hudson, Bob Carey and Ida Mae Goad on Dec. 18, Carrie Harris on Dec. 21, Juanita Prater on Dec. 9.

Happy Anniversary to Tom and Alice Bell Helton on Dec. 17, Mack and Linda Sides on Dec. 19, Thurman and Bobbie Horn on Dec. 20.

Wheeler Christian Academy Junior High Teams will play at Briscoe Monday, December 16 at 6:00.

We enjoyed the Christmas party at a XYZ at Mobeetie Friday night. Everything was decorated up so Christmasy and bright. Delicious food and friendly people. We also sang Christmas carols and exchanged gifts. Glad Mr. St. John and Laverne Scribner were able to be back with us.

Pray for Mack Shields. His eye has taken a turn for the worse and he is having to go back to doctor every day for a few days. Hope doctor can help. May have to have surgery. Was looking better Monday.

Tina Lehman and Shawn Young were united in marriage Saturday, December 7 at the home of the groom's parents, David and Pat Young in Canadian. Also there were Tina's parents, Al and Sue Lehman, Mike and Leann Lehman, and Brian, Tonya Wilson and Amber and Justin, Cheryl Hudson and other relatives. A pretty wedding.

Jack Morgan and James Moffett took a group to the District FFA Banquet at Booker Monday night Dec. 1. Those going were Dallas Fillingim, Dustin Walker, David Hale, Corey Kinnaman, John Moffett, Mary Lou Swigart, Amanda May, Misty Hallett, Jamey James and Caaron Laverty.

Remember Preston Glazner in your prayers. He had a heart attack and is in St. Anthony's Hospital in Amarillo.

Sue Ratliff has been working at the Abraham Home in Canadian.

Spending Saturday night with E.G. and Willa Fillingim were Randy Singleton, Kathy Psaris and Misty Herd. Randy and Kathy and Andy and Lisa Singleton and Gayle and Helen Singleton went to Shamrock Sunday to the National Guard Christmas dinner and party. Timm and Melody Rodgers and Gabriel also went to the party.

In the Miami tournament Kelton boys defeated White Deer, Higgins and Miami, but lost to Booker. They won third and are doing really well. In Friday night's game, Brian Kirkland scored 24, Boyce Crowner 20. Claude boys defeated Booker to win first in the tournament. Sunray girls defeated Groom to win first.

Evelyn Meek spent Thursday in Amarillo and spent the night with Kathy Meek at Canyon. Sandra Meek spent Friday night with Evelyn. Saturday Evelyn went to Wheeler to the Extension Homemaker. Council's Christmas party at Wheeler Church of Christ.

Nice to see Doris Finsterwald in Thriftway. She and Jack were on their way to play 88 at Claudy and Ina Mae Brotherton's Saturday night. Also there were C.B. and Maurine Brotherton. Nice to have Bob and Vicky

Greenwood and Misty and Brandy Mumford, Missy Barr, Margaret Morris, Misty Hallett, Katie Jo Mabry, Jamey James meet us for supper at the Dairy Queen Saturday night and a good visit. Also there were Norma Leake and granddaughters Sandy and Katie Nichols and their mom and Sandy's beautiful baby. Bob and Vicky and girls planned to spend Christmas visiting Bob's family at Eufala, OK, and Vicky's family near Beaumont.

Claude Laverty got out of the army Thursday and his dad met him at the Amarillo airport. Nice to have Claude out to games and church Sunday.

Elissa Ray visited Londa Crowner Friday. We were discussing at Gageby Church Bible Study Wednesday night Revelations 11:12 "And they heard a great voice from heaven saying unto them 'Come up hither' and they ascended up to heaven in a cloud—". And we thought of how exciting it would be to hear Jesus say to us "Come up here." A dear lady Doris

Newsom, 83, of Allison got her summons sometime Friday night or early Saturday morning. We will miss Doris but rejoice that "she has a new body. Praise the Lord! She has a new life." Sincere sympathy to all the family and friends. Funeral was Monday at Allison Baptist Church.

Sunday afternoon Roy and Lois Meadows and Evelyn Meek went to Canadian to the Middle School Drama Department presentation of music, comedy and dancing and the "Best Christmas Pageant Ever" and really enjoyed it.

Laura Meadows and Josh Wilson (Becky Vise's son) had parts in it. Sorry we missed it. Jace Baker also was in it.

There was a large crowd of relatives, friends and former students out to the funeral for Mrs. Doris Newsom at Allison. She had taught English and maybe other things in Allison for 37 years. When they asked former students to stand up, a big percent of the congregation stood. There was

enough food for "Cox's Army" as the old saying goes. Plenty for dinner and supper for everyone.

Roy and Lois are expecting Rick and Lucy Lucas and Charissa and Russell from Westport, Kentucky and Larry and Pam Meadows and Sarah, Gordon and Brandon from Dallas and Eddie and Leta Meadows and Laura and Amy to spend a few days during the holidays.

Dusty Walker is sick with the flu and will have to not play a few days. We will miss him Tuesday night. Hope you are soon well, Dusty.

Bobby and Mary Nell Finsterwald went to Lubbock Monday to check on their new house. Almost ready and looking good. Will be delivered some time early in 1992, hopefully.

Nice to see Ty and Christina Swift and Kaysi out to Briscoe Monday night. Beautiful baby.

"It is better to suffer wrong than to do it, and happier to be sometimes cheated than not to trust" Samuel Johnson.

"The gem cannot be polished without friction, nor the child of God perfected without adversity."

Isaiah 46:4 I will be your God through all your lifetime, yes even when your hair is white with age. I made you and I will care for you.

"We wish you a Merry Christmas and Happy New Year."

Give love this Christmas." We had a nice Christmas card from Robert Hall. He is at Ft. Ord, Calif. Lilly (Sumpter) Moore and Ty are still in North Carolina in the Army. Hopes to be down this way during the holidays.

Nice to have Brad and Sue Chandler and Jana and Bridget and meet us for lunch at Moxey's Sunday. Lots of nice people eating there. Good to see, Rev. David and Karen Campbell there with Rev. and Mrs. Robert Helsey, Jimmy and JoAnn Helton and Adrian and Dorothy Risner, Rev. Campbell and wife are missionaries to Brazil and preached at Wheeler Sunday while on furlough. David held a revival at Gageby in 1979 which blessed us all.

Did you see the picture of Butch Murray helping to construct a recycling place at Pampa? It was on the front page of Pampa's paper.

I had a good visit on the phone with Jolene (Steen) Jones. She and Wayne have sold their place on the Perryton Highway and moved into Canadian. Jolene is studying to be an R.N., making many trips to Amarillo. David Jones, who was very critically hurt, especially in the head, in a rig accident a few years ago, is making good progress. Everything had to be re-learned. He is in a fantastic home in San Marcos. Everyone has household chores; everyone goes to work. He can now carry on a conversation and walk a little bit, but uses a wheelchair. For the first time he is able to come home for a week. Wayne plans to fly down December 20 and bring David back to stay till Dec. 27. Harold Jones, his dad, is still able to live alone and walk with a cane and drive to the post office and grocery store in Canadian. Dwight Jones is taking radiation for lung cancer. He is very ill. Pray for them all.

A small number of faithful fans trekked to Darrouzett Tuesday night to see B.H.S. boys play Darrouzett Co-ed team. The score was Briscoe 99 and Darrouzett 40. Everyone got to play. David Hale 18, Dallas 11, Kevin Shields 6, Travis Goad 12, Dusty Walker 27, Donnie Bell 13, Jimmy Nelson 9, John Moffett 2, Josh Purcell 1. Nice to see Jack Webster there. He is retired from teaching, but Fern still teaches. Think Jack coached at Briscoe in the 1960's and they had four cute little kids, all grown now.

In Thursday's tournament at Miami B.H.S. lost to Clarendon boys 41 to 55. We missed Danny Nelson in his rebounding and shooting, but boys played good. The B.H.S. girls defeated Clarendon in a good game 53 to 46. We also watched Stacey Phillis play with the White Deer girls to defeat Miami J.V. and Kelton defeat White Deer Bucks 67 to 60. Later Allison boys defeated Darrouzett 49 to 42; Allison girls defeated Pampa J.V. 56 to 31, Allison defeated Miami girls 52-44 Friday.

You can not spell Christmas without Christ.

Nice to see Monett Treadwell Jenkins at the Miami Tourney. Also visited with Kelton's coach, Brad Slatton's parents. They drove up from Benton, near Little Rock, Ark. to see the games. They are retired teachers and nice people, very interested in the history of this area. Mayor Monett is still as friendly as when I was her fourth grade teacher. Also visited with David Lowry's wife from Clarendon. They had a boy playing. David, an ex Briscoe graduate, still teaches at Clarendon College. One woman go two technicals and was escorted out of the gym.

WHEELER MENU

Dec. 16-20
MONDAY: Breakfast: Juice, cereal, toast, milk.
Lunch: Hamburgers, cheese, pickle, French fries, milk/tea, applesauce.
TUESDAY: Breakfast: Juice, sausage, toast/gravy, milk.
Lunch: Chili, carrot stick, pickle, crackers or cornbread, milk/tea, pears.
WEDNESDAY: Breakfast: Juice, cinnamon rolls, milk.
Lunch: Turkey pockets, curly Q's, apricots, milk/tea, strawberry gelatin.
THURSDAY: Breakfast: Juice, hash browns, sausage, toast, milk.
Lunch: Fish nuggets, macaroni and cheese, English peas, cornbread, milk/tea, chocolate cake.
FRIDAY: Breakfast: Juice, cereal, toast, milk.
Lunch: Ham & cheese sandwiches, later tots, peaches, milk/tea, cookies.
Menu subject to change.

In Friday's games with Groom at Miami, both our girls and boys teams got off to a slow start, intimidated by their height. They had one girl 6 foot 1 inch and two 5'10"s. Final score was Groom 53, Briscoe 34. Our boys got within 3 points of Groom, but finally lost in a hard fought game, 51 to 57. We are proud of you, kids. Better luck next time.

Oh-Oh we play Groom in the Samnorwood tournament Thursday, Dec. 12 at 7:00 and 8:30 p.m. Go get 'em kids!

Dale and Lisa Helton and David, Doug, Matt, and Mark are expecting Lisa's mom, Mrs. Katie Cunningham from Indiana to come Saturday to spend two weeks or so with them over the holidays.

Sorry to hear the Briscoe Extension Homemakers Club has disbanded



Happy 15th, Sunshine
We Love you lots, Mom, D. and D.

The Stitch & Chatter Shop
(Next Door to the SPS Office)

If you have children's clothing size infant thru size 14 or 16 that's in excellent condition or children's furniture that's in good condition, and would like to sell these on consignment come by or call the Stitch and Chatter Shop for more information. Also would like after 5 clothing, all sizes

Open through the Noon Hour, Also
Call Mary Risner at 826-3608



VALERIE, 12 years, Kristl, 17 years, SKYLER, 2 1/2 years are the children of Stanley and Sharen Simpson of Pampa. Grandparents are Mr. and Mrs. W.C. Simpson of McLean and Loraine Wagner of Wheeler.

For all your... Insurance Needs, See The McCasland-Smith Agency
117 W. Texas St.--Wheeler, Tex. 806/826-3573
*Auto *Home *Life *Health *Commercial *Bonds

because of illness and other problems. It has been going many years. Don't forget Briscoe-Mobeetie Christmas program will be Thursday night December 19 at 7:00 at Mobeetie School.

We had some exciting junior high games at Briscoe with Lefors Monday night. Briscoe boys won 50 to 37. David Helton 17, Bobby Blackburn 11, Steven May 11, Collin McCurley 10, Donnie Barr 1. Briscoe girls won 23 to 17. Misty Walker 6, April Purcell 7, Stacey Dukes 8, Michelle Selby 2. Also playing were Dana Trimble, Tiffany Gonzales, Brandi Luttrell and April Finsterwald. Both teams looking good!

Thanksgiving day visitors in the home of David and Winnie Gilmer, Tonya, Brandon, Julie and Davy were Mr. and Mrs. Ed Gilmer, Mark Gilmer, Vanessa Vaughn and Tera, Till and Daryl Snelgrooves, Mique and Will, Millie and James Williams, Angie and Jesse Taylor and Jamie from Wheeler, Venson and Fay Smith, Trish and Walter Hand and Monty, Marlin and Bonnie Thomas, Roy Johnson's from Borger, Thad and Tammy Green. David and Winnie enjoyed having an old Army buddy and his son Ray and John Hill from Camden, Tenn. spent last week with them. There was a lot of visiting and hunting going on. Trish and Walter, Monty Hand had supper with David and Winnie Gilmer Sat. evening.

Tammy and Thad Green visited David and Winnie Gilmer Friday evening.

Trish and Walter Hand and Monty and Winnie Gilmer visited Venson and Fay Smith awhile Sunday afternoon. "God be with you till we meet again."

Meals (From Page 1)

for 1991. It is our goal to lower the cost of the meals to the recipients, and we are grateful for all the volunteers that have worked with and for us since March 11, 1991. I'm sure they get a feeling of satisfaction for being able to help someone.

The Meals on Wheels Board of Directors are: Amelia Sims, Polly Hooper, Evangeline Wills, Marci Wright, Betty Hennard, Bobbie Carol Hill, Joan Gray, Bill Robertson, Pat Pollan, Bob Wills, and Jimmy Adams. This meeting will be strictly a business meeting, but if anyone wishes to sit in on it, they will be welcome.

WHEELER MENU

Dec. 16 - 19
MONDAY: Lunch: Steak fingers, mashed potatoes, English peas, hot rolls, ice cream.
TUESDAY: Lunch: Goulash, tossed salad, fried squash, cake, Texas toast.
WEDNESDAY: Lunch: Beans, spinach, French fries, cornbread, apple turnovers.
THURSDAY: Lunch: Tacos, lettuce, tom., cheese, fruit.

M-Boot and Saddle Shop
Open 8:30 til 4:30
Mon thru Fri.
We do Custom Belts & Billfolds
711 E. Oklahoma St.
Phone: 826-3718
Wheeler, Texas

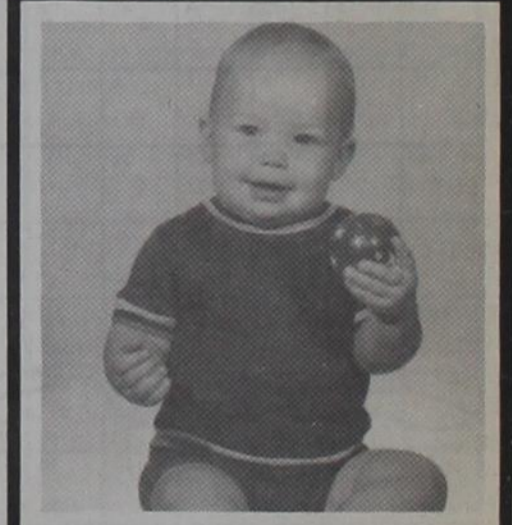

Happy 21st
You all know Justin
Mom knows Bo

WATCH OUT, SPARKY! WATCH OUT!

LEARN WHAT CHRISTMAS SAFETY'S ABOUT!

A CHRISTMAS SAFETY CHECK

- Before hanging strings of lights, spread them on the floor and check for frayed or bare wires, cracked insulation, loose connections, and damaged plugs or light sockets.
- Check extension cords for wear or damage and don't run them across walking areas.
- Test lights before putting them on the tree. Unplug them before making repairs or replacing bulbs.
- Overloading circuits with too many lights can cause fire. Follow manufacturer's instructions about the number of lights allowed on one circuit.
- Never string lights on a metallic tree.
- Choose a fresh, green tree, trim its base and keep it in plenty of water. If the needles are brown and break off easily, it could be a fire risk.
- If you buy an artificial tree, make sure it has been tested for flammability by Underwriters Laboratories (UL).
- Always turn off lights before leaving home or going to bed. You'll save money and be safer, too.
- Do not use inside lights on the outside. All outside lighting equipment, including lights, cords and plugs, should be waterproof and made for outdoor use. Also, hang sockets downward and don't leave a socket empty.
- When hanging lights on the rooftop or in tall trees outdoors, stay clear of electrical lines.

Call Your SPS office for other safety tips.
Wishing You A Safe, Happy Holiday

SPS SOUTHWESTERN PUBLIC SERVICE COMPANY

Just Received For Christmas
Isotoner Slippers

All Ladies **COATS**
1/2 Price

McIlhenny
Phone 826-5688
DRY GOODS

WHEELER Texas