

**SAVE \$40!  
Colonial Group in  
Nubby Cotton Tweed!**

Includes sofa and chair. Both pieces quality crafted for years of comfort.

Built with resilient steel springs and kiln-dried hardwood frames. Back cushions with 4 in. of deep foam padding.

Graceful winged backs and kick-pleated skirts for Colonial touch!

Regular 329.95 Value

**289<sup>88</sup>**  
BJ2583

CREDIT AVAILABLE



**YOUR CHOICE**



**SAVE \$9  
Modern or  
Colonial Swivel  
Rocker**

Both chairs have hardwood frames and thick foam padding. Scotchgard® treated fabric resist spills and stains.

Colonial chair in gold cotton print. Modern chair in rayon & cotton upholstery.

Values  
to **64<sup>95</sup>**  
BJ24045



**SAVE \$10  
Rustic  
Boston Rocker**

Features deep, dark pine finish over quality European Pine construction.

Gold-colored trim defines the carved splats, armrests, spindle legs and cross members.

Regular 99.95 Value

**89<sup>88</sup>**  
BJ2490



In brown,  
black or  
avocado!

**SAVE \$19  
Rocker  
Recliner**

Grained vinyl upholstery over kiln-dried hardwood frames and no-sag steel springs. 3 in. thick foam padding. In colors.

Reg. 108.95 Value

**89<sup>88</sup>**  
BJ2415-17

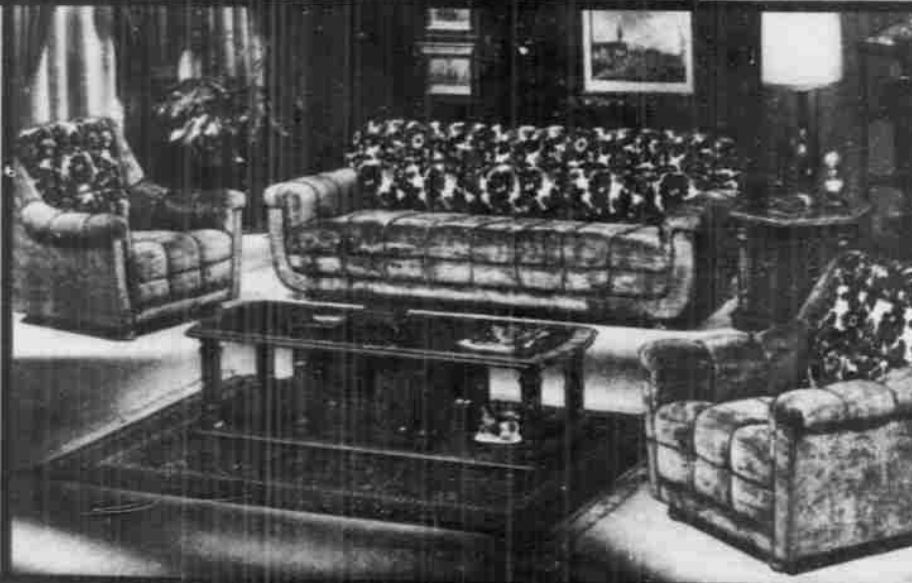

**SAVE \$30  
Plush 94 In. Sofa in  
Elegant Velvet!**

Generously proportioned sofa with deeply rolled biscuit tufting & piping. Arms, seat and base in shimmering gold velvet, carved floral motif graces back.

Comfortable foam padding cradled on steel springs.

Regular 269.95 Value

**239<sup>88</sup>**  
BJ2786

Mr. Chair 8J2787..... 119.88  
Mrs. Chair 8J2788..... 124.88

Any item not in stock is quickly available.

Make baby's Christmas a happy one! See our selection of infant needs.



### SAVE NOW! Fun Hoola Coupe® Walker

Reg. 14.95 Value—Keeps your baby happy and occupied while you relax!

Features six swivel wheels and 24" stabilizer ring. Chrome-plated steel frame.

**13<sup>88</sup>**  
BJ9062



Any item not in stock is quickly available.



### SAVE \$3 NOW! Deluxe 3-Position Folding High Chair

Sturdy chrome-plated tubular steel frame with tip-resistant legs. Non-skid white ball caps won't mar floors.

3-position tray and footrest made of hi-impact plastic. Floral pattern vinyl seat pad is removable for easy washing. Safety strap keeps baby safely secured in chair.

Regular 27.95 Value

**24<sup>88</sup>**  
BJ9022



### SAVE \$5 NOW! Our Deluxe Sleeper / Stroller

Pleasant cuttings for baby! Pretty patchwork vinyl upholstery with melon-color canopy, plastic windbreaker.

Has padded 3-position backrest, safety-lock footrest. 3/4 in. tubular telescoping handle. Metal basket and bumper.

Regular 39.95 Value

**34<sup>88</sup>**  
BJ9306

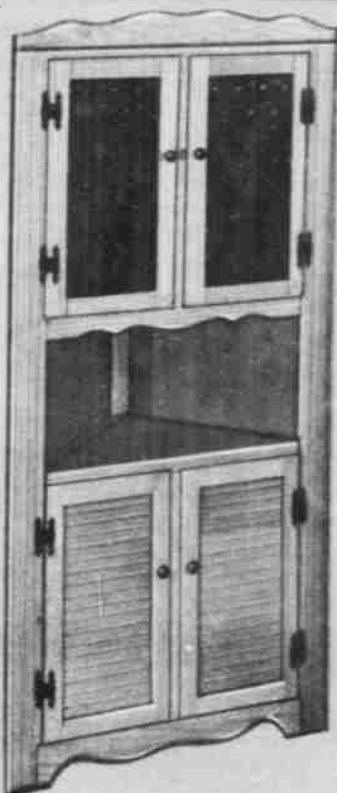

### SAVE NOW! Colonial Corner Cabinet... sanded, assembled, ready to finish!

Regular 69.95 Value—Cozy cabinet has lots of uses! Makes an ideal space-saving bar or handy storage area. Features rugged pine hard-board construction. Has 2 top, 2 bottom shelves. Plastic amber top doors. Measures 33x33x70 in.

**59<sup>88</sup>**  
BJ4241

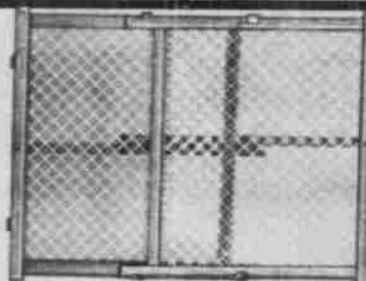

**Rugged Safety Gate 7<sup>99</sup>**  
BJ9011  
Adjusts from 24 1/2 to 39 in. Handy!



### Comfy Little Bear Baby Trainer

Non-toxic white plastic seat, deflector, tray. Hardwood frame. Priced right!

**7<sup>99</sup>**  
BJ9050

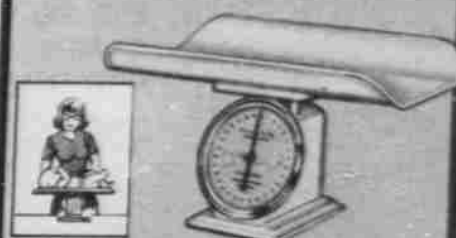

**Handy Baby Scale 9<sup>99</sup>**  
BJ9410  
Reg. 11.49—From 0 to 30 lbs.



# Use convenient credit!

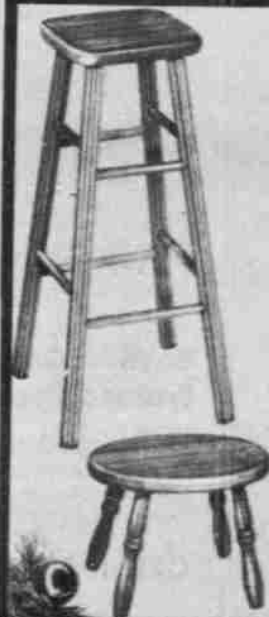

### SAVE 2.20 Unfinished Bar Stool

Made of solid Lauan mahogany! Ready to paint or stain. 30 in. high. So handy!

Regular 7.19

**4<sup>99</sup>**  
BJ4235

### SAVE Utility Stool

Lauan mahogany! 13x10 in. high.

Regular 2.29

**1<sup>77</sup>**  
BJ4236



### SAVE \$10! Colonial Desk and Chair Set

Features Ponderosa pine construction with charming Salem maple finish. All joints are glued and nailed for extra strength.

Four drawers have brass-plated pulls. Desk is 30x30x17 in. deep. Matching spindle-type chair measures 28 in. high.

Regular 49.95 Value

**39<sup>88</sup>**  
BJ1231

# CHRISTMAS

## 1975 AT

Supplement to:  
Lamb County Leader News  
Lamesa Press Reporter  
Plainview Daily Herald  
Hereford Brand  
Hillsboro Reporter  
Ennis Daily News  
Clovis News Journal  
Brownfield News  
Dalhart, Texas

Prices quoted are good till expiration date listed on front page. We reserve the right to limit quantities and correct printing errors. Prices subject to change without notice.

# GEBO'S



THE NEW GENERAL STORE OF THE SOUTHWEST!

PRICES GOOD DEC. 1ST  
PRICES GOOD AT  
ALL 11 GEBO'S  
STORES!

PLAINVIEW, TX. - 426 Ash Street	AMARILLO, TX. - 2500 E. Third
HEREFORD, TX. - 230 N. 25 Mile Ave.	LAMESA, TX. - 208 S. Dallas
LITTLEFIELD, TX. - 508 Hall Ave.	ENNIS, TX. - Old Hwy. 75 South
LUBBOCK, TX. - 215 - 50th & A	HILLSBORO, TX. - 803 Abbott Ave.
BROWNFIELD, TX. - 1604 Lubbock Rd.	CLOVIS, NM. - 101 N. Sycamore
DALHART - 101 Denrock	

Due to fluctuating market conditions, we must reserve the right to change prices without notice, to reflect current costs. Items advertised were either in stock or confirmed for shipment prior to sale dates. Market conditions beyond our control, will sometimes result in late deliveries on items advertised. All prices listed were current at press closing time.

# GEBO'S

December 10

... given to or percent. Data reductions were assigned to 18 percent of the samples classed.

discuss use of IMCA Management Orientation Program for City Internal Training. discuss City Engineer

the bench to do good  
The varsity girls de  
54-48.



Elegant Velvet!

Made of solid  
Lauran mahogany!  
Pencil in pocket

## SOUNDESIGN

AM/FM Stereo Receiver with built-in 8-track tape player and two wide-range speakers.

REG. \$144.95

- Slide controls
- Mike/Guitar Jack
- BSR Changer
- Diamond Stylus
- Includes: Dust Cover
- 45 adapter, FM antenna
- Audio Cables

MODEL 4469-625-435

Reg. 146.95

SPECIAL .....

**\$139<sup>95</sup>**

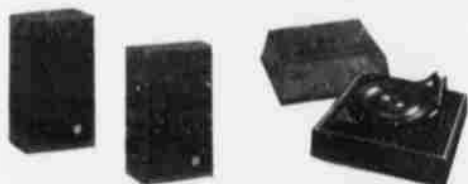

## SONY

### FM STEREO, FM/AM RECEIVERS & RECORD PLAYER SYSTEM



MODEL  
HP 258/55250

GEBO'S  
PRICE .....

**\$340<sup>00</sup>**

- 8-Track Cartridge Player/Recorder
- Automatic Record Level Control
- Automatic/Manual Program Selector Switch
- Automatic Stop Control for all four program tracks
- 3-speed BSR auto/manual turntable with tonearm cueing lever and anti-skating compensation
- SONY ceramic cartridge and diamond stylus
- Automatic FM mono-stereo program switching with signal light
- FET Front-end FM tuner
- Solid-state all-silicon transistor amplifier
- 6+6 W RMS Continuous, 25 W EIA Music Power

## SANYO



### STEREO MUSIC SYSTEM

- AM/FM Stereo Receiver
- 2/4 Channel 8 Track Tape Deck
- Garrard Record Changer

Limited Quantity  
SPECIAL .....

**\$184<sup>95</sup>**

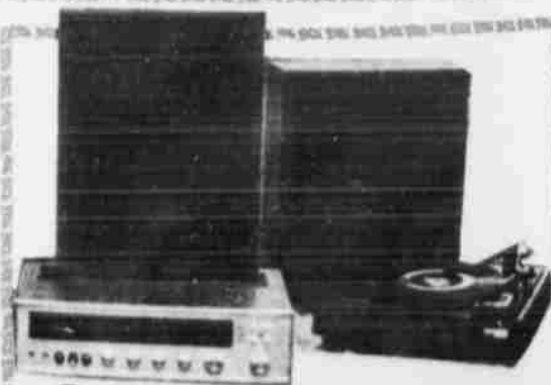

### SANYO SYSTEM 1 - 2-CHANNEL AUDIO COMPONENT STEREO SYSTEM

Sanyo DCX2700KA stereo receiver, BSR automatic record changer with Sure magnetic cartridge and diamond stylus, base, and dust cover. Two high fidelity 3-way Polyphase SX-165 speaker systems. Craig model 3307 8-track, Stereo Recorder Deck included.

LIST PRICE 544.80

GEBO'S  
PRICE .....

**\$298<sup>00</sup>**

**GEBO'S**



# SONY

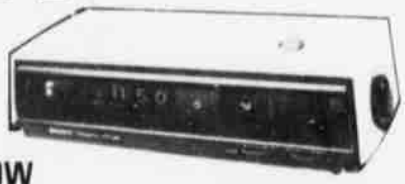

## TFM-C660W

An FM/AM Digitalic Lifetime clock radio that tells time and more in glowing form.

- Digitalic Lifetime system gives time, day and date in glowing light
- 24 hour alarm system for preset convenience
- Choice of waking to radio or buzzer alarm
- Alarm level volume control
- Snooze Bar, for an 8 minute snooze before alarm goes off a second time
- Sleep Time turns set off automatically, after listening interval of up to 90 minutes
- Simple tuning, rich sound and continuous tone control for full listening comfort

**GEBOS PRICE \$69<sup>95</sup>**

# WESTCLOX

## DIGITAL ALARM CLOCK



**GEBOS PRICE \$14<sup>98</sup>**

## WESTCLOX DAY DATE III TRAVEL CLOCK

Reg. 6<sup>39</sup>

**\$5<sup>95</sup>**

SPECIAL .....

# SOUNDESIGN



## AM-FM CLOCK RADIOS SOUNDESIGN DIGITAL

Special

**\$33<sup>95</sup>**

- 3483 SOUNDESIGN DIGITAL
- AM/FM Digital Clock Radio
  - Wake to music or buzzer
  - 24-hour lighted leaf face
  - Side control function switch, tone, and volume

# SOUNDESIGN

5143

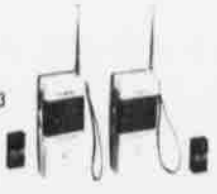

## WALKIE-TALKIES

GEBOS PRICE

**\$11<sup>95</sup>**

- Crystal controlled
- Push to talk button
- Adjustable volume control
- 3 1/2" speaker
- 40" antenna
- 100 mW, 27.125 MHz
- Includes carrying strap and batteries



- Features the GE Snooz-Alarm repeat alarm
- Low cost, compact design
- Easy read dial and hands
- Height 2-7/8", Width 3-7/8", 7371 Ant. white

Special

**\$3<sup>98</sup>**



- o Ultra modern dual-feature alarm clock
- o Lighted dial makes night viewing easy
- o Convenient Snooz-Alarm Clock
- o Height 5-1/8", Width 3-7/8", 7351-412 Black

GEBOS PRICE

**\$9<sup>98</sup>**



## WARMCREST AUTOMATIC BLANKETS

Blend of 45% Polyester, 30% Acrylic, 25% Nylon. Popular control with night light. Machine wash, tumble dry. Mothproof and non-allergenic, 100% Nylon binding, 2 year guarantee. Available in Blue, Gold, Green and Pink.

3481 Double Bed  
Single Control  
72" x 84"  
SPECIAL

**\$14<sup>98</sup>**

3482 Double Bed  
Dual Control  
72" x 84"  
SPECIAL

**\$18<sup>95</sup>**

# GEBOS

**FOUNDENIGN STEREO HEADPHONES**

Enjoy your favorite music privately without disturbing others. This expertly crafted headphone features comfortable, padded earpieces, adjustable headband and a 15 ft coiled cord.

**Features:**

- Cushioned earpads
- Adjustable headband
- Frequency response: 20-18,000 Hz
- 15 ft. coiled cord



Reg. 7.95

SPECIAL . . . .

**\$5<sup>95</sup>**

**Open All Day  
Saturday  
thru Christmas**

**PORTABLE  
ELECTRIC  
HEATER**

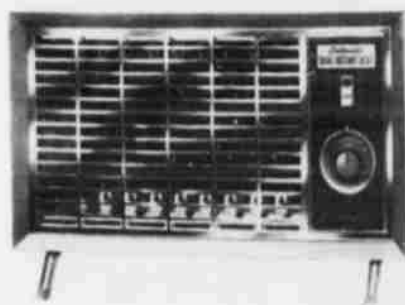

Deluxe Automatic Fan Heater, dual heat, flip-over switch, instant heat, safety chrome grill, hide-a-way handle, push button switch, cool case. Wattage 1320-1600. U.L. listed.

SPECIAL

**\$16<sup>97</sup>**



**SANYO**

PORTABLE CASSETTE

**TAPE  
RECORDER**

M2522

GEBO'S PRICE

**\$39<sup>95</sup>**

- Digital tape counter
- Automatic shut-off
- A-C, D-C operation
- Automatic record level circuitry
- Built-in condenser mike
- IC amplifier
- Eject button

**Regal**

automatic electric  
**S-L-O-W COOKER**



Mealtime masterpieces are a snap with the new Regal Poly Pot. Soups, stews, roasts, boiled dinners, pudding or sauces are done to mouth-watering perfection - the gentle, slow cooked way. No tedious pot-watching or stirring are necessary. Poly pot is completely automatic with no dials to set. Model K7933.

GEBO'S  
SPECIAL . . . . .

**\$12<sup>49</sup>**



Model K6727

Watch it pop over in your mouth popcorn, butter it and shut off automatically. Flip over and use cover as serving bowl.

SIMILAR TO ILLUSTRATION

GEBO'S  
SPECIAL . . . . .

**\$9<sup>99</sup>**

**GEBO'S**



**NEW From  
HAMILTON  
BEACH Scovill**  
Deluxe

**CAN OPENER/  
KNIFE SHARPENER**

Model 831  
Available in Gold

Reg. 12.60  
SPECIAL.....

**\$10<sup>99</sup>**



**PRESTO  
ELECTRIC CAN  
OPENER / KNIFE  
SHARPENER**

One-lever Controls  
pierce and open cans at every shape and  
size. Safety, Clean! Removable handle con-  
trol and cutting wheel make cleaning easy.  
Keeps knives sharp as new.

**SIMILAR TO  
ILLUSTRATION**

GEBO'S  
PRICE.....

**\$12<sup>90</sup>**



Model 525  
White

**NEW From  
HAMILTON  
BEACH Scovill**  
Portable  
Roaster  
Oven

- Automatically bakes, roasts, stews, cooks complete meals for two or fifty people and it's portable.
- Ideal for picnics, family outings, barbecues or patio meals.
- Cooks a meal anywhere there is an electrical outlet - take it with you in the roaster where it stays warm for hours.

**SPECIAL**

**\$48<sup>95</sup>**

**HAMILTON  
BEACH**

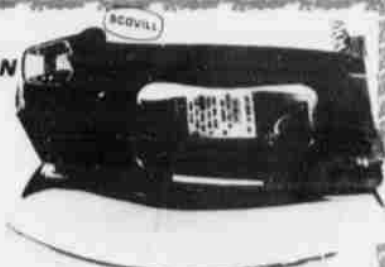

**"NO SCORCH  
IRON"**

No 3794 S. G. With exclusive "No-Scorch" steam and spinning spray at the bottom of a tubular No-Scorch, clothes and colors stay like new when you have washed correct temperature. Wash-winter. 69 cents.

Reg. 24.95  
SALE  
PRICE

**\$19<sup>95</sup>**



**Hamilton  
Beach**

3-SPEED

**HAND MIXER**

97-3-Speed Hand Mixer. An electric expert with 3-speed fingertip control; chrome-plated beaters, beater ejection button.

**SPECIAL**

**\$8<sup>49</sup>**



Model 640 and 694  
Available in Avocado and Gold

**NEW from  
HAMILTON  
BEACH Scovill**  
14 Speed  
Blender  
Plus™  
Blender

- Three versatile extra containers can be used to blend, store, 'n serve a variety of liquid drinks.
- Includes 40 oz. regular container, 48 oz. 16 oz.; and 12 oz. Blender Plus containers
- Powerful 14-speed blender with Hi-Lo selector switch and Insta-Blend button.

**SPECIAL**

**\$22<sup>95</sup>**

**GEBO'S**





**9 Cup automatic PERK**  
by  
**West Bend**

New design perk brews 5 to 9 cups of coffee. Features a safety lock-on cover.

Harvest, Poppy or Avocado

Reg. 10.49

SPECIAL . . . . . **\$8<sup>88</sup>**



Exclusive double-filter system!

**FLAVO-DRIP™**  
**COFFEEMAKER**

BREWS 2-8 CUPS IN 60 SECONDS PER CUP

Flavo-drip makes 8 cups of your favorite brew in just 8 minutes. Warming plate keeps clear, fresh coffee hot cup after cup. Heats water for tea, soups and other instant, too! Double-filter system with both easy-to-use paper and permanent fine mesh filters.

*Special*

**\$22<sup>95</sup>**

SIMILAR TO ILLUSTRATION

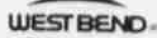

30 CUP

**PARTY PERK**

Brews 12 to 30 cups of delicious coffee and keeps it hot for hours, automatically. "Serve" light signals when coffee's ready.

**\$11<sup>95</sup>**



**Colorful "Bake 'n Broiler"**

**4-in-1 Pan**

Bakes, Broils, Cools, Roasts  
**SPECIAL**

**\$4<sup>95</sup>**

FIRED-ON  
NO STICK  
INTERIOR

Genuine  
**Porcelain**

HARVEST GOLD

**COUNTRY INN™**

Avocado, Butterscotch  
or  
Harvest  
Exteriors

by



Genuine  
**Porcelain**



**Extra-thick ALUMINUM 7 PIECE COOKSET**

**SPECIAL**

Even-heating, efficient aluminum cookware is wrapped in genuine, dishwasher-safe porcelain. Sun-Ray interior. Set includes 1 1/2 and 2 1/2 qt. covered sauce pans, 5 qt. Dutch Oven and 10" Skillet that shares Dutch Oven Cover.

**\$23<sup>95</sup>**



WEST BEND 2 QT.

**BEAN POT**

Regular \$10.49  
SPECIAL . . . . . **\$8<sup>95</sup>**

## COOKER-FRYER

**CROCKER COOKER/FRYER.** A slow cooker — a regular cooker — a deep fryer. Three great appliances in one compact unit. Crockery vessel plus low heat settings. Retains food flavors without drying out. Or, remove the crockery vessel and use it like a regular cooker-fryer. Crock can be washed in dishwasher. 5 qt. capacity has porcelain finish, interior Teflon finish. Glass cover. Thermostat control, cooking guide, aluminum fry basket.



Model 9-13

SUNBEAM

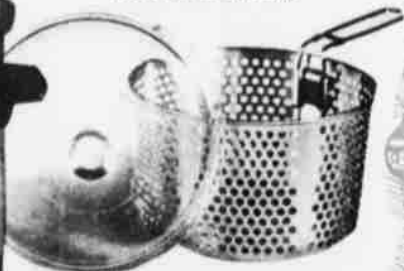

**GEBO'S PRICE**  
**\$39<sup>95</sup>**



**PRESTO  
AUTOMATIC  
TOASTER**

**T02**  
Perfect toast in seconds — automatically! Color selector, hinged crumb tray. Gleaming chrome with woodgrain end panels. Compact for easy storage.



**SPECIAL**

**\$14<sup>95</sup>**

## PRESTO ALUMINUM

There's a sturdy, easy-to-handle Aluminum Presto Cooker for every need. 4 and 6 quart sizes for small or large families. Each has all the exclusive Presto features to assure faster, better cooking. Harvest Gold. Stamped Aluminum.



**SPECIAL**

**STOCK NO. PCA4**  
4 quart size  
Shpg. Wt. 4 lbs.  
Reg. 16.49

**\$13<sup>95</sup>**

**STOCK NO. PCC4** **\$13<sup>98</sup>**  
4 quart size  
Shpg. Wt. 4 lbs.

**STOCK NO. PCA6**  
6 quart size  
Shpg. Wt. 5 lbs., 4 oz.

**\$15<sup>95</sup>**

**STOCK NO. PCC6** **\$17<sup>49</sup>**  
6 quart size  
Shpg. Wt. 6 lbs.



## SUNBEAM

Similar To Illustration

**DELUXE MIXMASTER MIXER WITH DOUGH HOOKS.** Powerful 225-watt governor-controlled motor — maintains pre-set speeds. 12-speed Mix-Finder dial, eliminates guess-work. Dough hooks for kneading home-made breads and mixing heavy batters. Bowl-fit beaters mix thoroughly, evenly. Automatic bowl rotation. Rich woodtone handle and Mix-Finder dial. Colorful recipe/bread book.

MODEL 1-71 OR 1-73

**SPECIAL**

**\$61<sup>95</sup>**

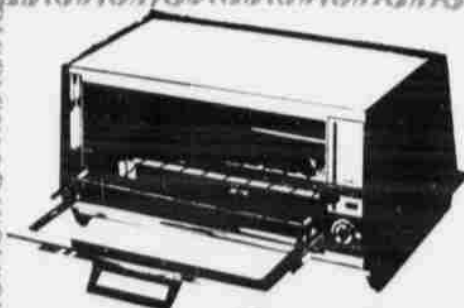

**GENERAL ELECTRIC**

**DELUXE TOAST-R-OVEN  
TOASTER**

MODEL T93B/3103-012

All the general features listed above, plus:

- Thermostatically controlled oven with 200° to 500° settings for baking.
- Horizontal toasting accommodates thick or thin odd sizes or shapes of breads and toaster pastries. Both sides toasted at once; automatic shut-off when toasting is complete. Toast Color Control to select desired shade of toast.
- Top Brown setting for browning just the tops of snacks.

**SPECIAL**

**\$34<sup>95</sup>**

**GEBO'S**

GENERAL ELECTRIC

# ZOOM PLUS DRYER / DETANGLER

DD-1 Dryer/Detangler • 600 watts of drying power plus high air-flow design • Power Detangler attachment is ideal for getting tangles out of wet hair; works on all control settings • 3 control settings for comfort drying and styling • Wide-Tooth and Fine-Tooth Combs plus Styling Brush attachments for grooming/styling too.

Similar to Illustration

REGULAR \$11.98

SPECIAL . . . . .

**\$9<sup>99</sup>**



# NORTHERN Curling Wand

Quicker than a pin curl! Less bother than a bonnet dryer! As versatile as a hairer!

Model 2321

**\$6<sup>98</sup>**



# NORTHERN 1200 WATT Blower/Dryer

Powerful 1200 watt professional type pistol dryer for super Blow/Dryer action. Lightweight.

SPECIAL

**\$15<sup>98</sup>**

Model 1832



Now have beautiful hair fast without fuss



Cat. No. 34-11

# Get this Sunbeam Mist-Stick Curler/Styler FREE

when you buy a deluxe twin-head Lady Sunbeam electric shaver

One large head for legs plus One gentle head for underarms

Reg. 16.95  
SPECIAL



Cat. No. 76-26

\*Customer will be responsible for obtaining FREE merchandise including postage and handling.

840 watts of drying power.

# Get this powerful Sunbeam blower/styler

Cat. No. 52-94

# FREE

when you buy a Sunbeam Shavemaster Groomer

Cat. No. 75-19



Reg. 33.95  
SPECIAL

SHAVEMASTER GROOMER

Adjusts to trim sideburns, moustache or beard.

Customer will be responsible for obtaining FREE merchandise, including postage and handling.

**\$29<sup>95</sup>**

Ask about trade-in on old shavers.

GEBOS



YOUR COMPLETE JACKET HEADQUARTERS. LARGEST SELECTION EVER AT VERY AFFORDABLE PRICES!

# Weathervane QUILTED NYLON JACKETS

Black or Navy

**\$5<sup>95</sup>**

SPECIAL .....



**BIG SMITH**

Quilted Nylon Jacket  
Reg. 10.95

**\$9<sup>95</sup>**

Quilted Nylon Vest  
Reg. 7.49

**\$6<sup>47</sup>** Asst. Colors



Wallo's  
**super bowl coat**

Brown, Navy, Black

**\$16<sup>97</sup>**

SPECIAL .....

Wallo

**BLIZZARD-PROOF**

**ZERO ZONE**

Nylon Quilted Vest  
MEN'S

**\$8<sup>95</sup>**

**BOY'S VEST**

GEBO'S PRICE

**\$6<sup>95</sup>**

**LITTLE BOY'S VEST**

**\$5<sup>49</sup>**

Wallo's  
**BLIZZARD-PROOF**

INSULATED APPAREL

MEN'S  
INSULATED COVERALLS

Red or Black Olive  
Reg. 24.95

**\$23<sup>49</sup>**

BOY'S  
INSULATED COVERALLS

Red or Black Olive

GEBO'S PRICE .....

**\$20<sup>95</sup>**

Brown Duck  
INSULATED COVERALLS  
GEBO'S PRICE

**\$29<sup>95</sup>**

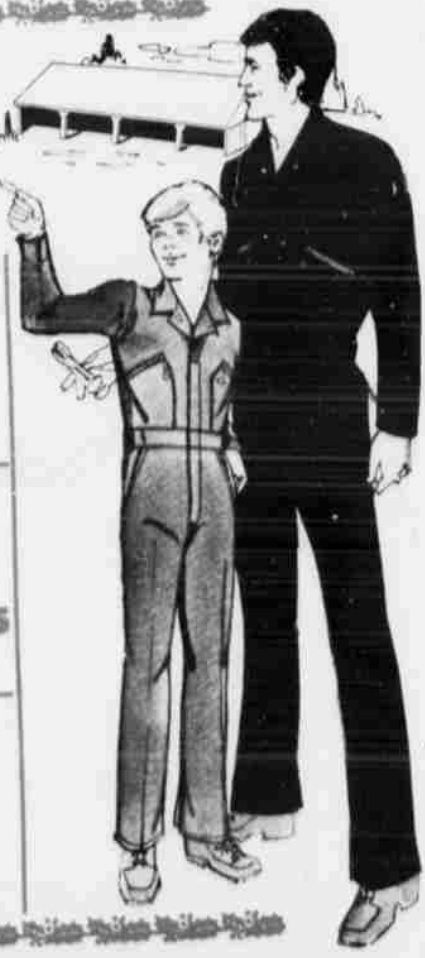

**GEBO'S**

**GEBO'S**

*Wrangler*

**and  
GEBO'S**  
think  
Americans  
spend too  
much for  
clothes.



And we're doing something about it.

The look is authentic western, and they're priced to give you a dollar's worth for every dollar you spend. Jeans and jackets the easy-going, easy-care cymbal with every casual western fashion feature. Available in he-man fabrics and colors in your size.

Jackets  
\$11.98 to \$15.95

Jeans  
\$9.00 to \$13.00

Shirts  
\$8.95 to \$12.95

**The Western Look  
by Wrangler**



**Healthknit**

*your model  
of  
comfort!*



The Healthknit blend of 50% Polyester/50% Cotton underwear is today's model of comfort and easy-care. T-Shirts feature popular sport neck contoured armholes and non-ravel sleeve hems. Briefs have seamless seats and are tailored for comfort and proper support. Healthknit — the Permanent Press underwear that doesn't let you know it's there! Get your models today.

MEN'S BRIEFS, 3 pr. pkg. . . . . 3.69  
 MEN'S T-SHIRTS, 3 pr. pkg. . . . . 3.59  
 MEN'S ATHLETIC SHIRTS, 3 pr. pkg. . . . . 3.25

**GEBO'S**

# WRANGLER 'NO-FAULT' DENIMS



100% COTTON  
14 oz. DENIMS WITH  
SANFOR-SET  
THAT AMERICANS  
WILL STAND UP  
AND SALUTE.

Wrangler also pledges freedom from wrinkles and freedom from puckers on the pockets and along the seams. What's more, Wrangler No-Fault cotton denims pledge they won't shrink more than 1%.

WRANGLER SANFOR-SET

# NEW

MEN'S AND  
BOYS SIZES  
Students 26-30 Reg.  
Sizes 6-14 Reg. & Slim  
AT  
VERY AFFORDABLE  
PRICES

So if you want the only 100% cotton denim jeans and jackets that are ready to wear right out of the dryer, march right into our store and ask for Wrangler No-Fault denims. After all, they're the only 100% cotton denims that can make such a pledge. And keep it.

Lambert  
BRAND

## CAPS

\$2<sup>79</sup> TO \$4<sup>49</sup>



## KNIT CAPS

\$1<sup>25</sup> TO  
\$1<sup>84</sup>

## THERMAL INSULATED SHIRTS AND DRAWERS

\$3<sup>68</sup> EA.

MEN'S  
ORLON  
DRESS SOCKS  
79' to 86'

MEN'S THERMAL  
SOCKS  
\$1<sup>59</sup>

# WRANGLER BOOTS

## Boy's Ranch Wellington

Natural full grain  
Leather, water  
repellant treated.

MODEL 17332T  
Reg. 19.95

\$17<sup>95</sup>

## Boy's Wrangler "Perma Welt" Ranch Wellingtons

MODEL 2993

\$13<sup>95</sup> Thick wear resistant sole  
is permanently bonded  
to the high quality upper.

## Wrangler Ranch Wellington

Brown premium cowhide, water repellant treated.

MODEL 5934  
Reg. 28.60

\$26<sup>95</sup>

## LaCross OVERSHOES 4 Buckle Cowboy Overshoe

\$10<sup>49</sup>

## 5 Buckle Overshoe

\$12<sup>60</sup>



SANTA ROSA

## Golden Tan Ranch Wellington

MODEL 8080

\$33<sup>95</sup>

SANTA ROSA

## Insulated Lace Up Boot

MODEL 818 Reg. 33.49

\$31<sup>95</sup>

GEBOS

GEBOS



## SAN ANGELO "QUICK MOUNT" GUN RACK

- FOR
- PICKUPS
  - PANEL TRUCKS
  - STATION WAGONS
  - RECREATION VEHICLES



NO. 85 FAST, EASY TO INSTALL,  
NO HOLES TO DRILL

REG. 4.69..... SPECIAL **\$3.97**

## Portable AIR TANK

10 GAL. TANK



Portable protection against costly down-  
field rips. Of heavy grade steel, baked  
enamel finish. 150 lb. working pressure.  
Comes complete with air hose, chuck  
and gauge.

SPECIAL

**\$18.97**

## SANBORN 1/2 H.P. AIR COMPRESSOR

No. 28450 10" x 10" tank with 3 & 1/2" wheels  
and handle. 2.4 C.F.M. ball bearing compressor built  
to fit electric motor. Motor start, overhead pro-  
tected. Complete with automatic start, pressure  
switch, check valve, air line strainer, air hose and  
chuck.

SALE PRICE ..... **\$97.50**

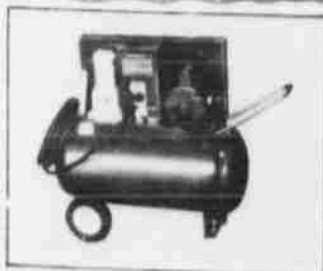

AMPCO

## TUNE-UP KITS

Includes: match vertilate, heavy duty contact points,  
condenser and rotor. Easier starting. Better gas mileage.  
High performance is assured the owner of a car prop-  
erly tuned with an Ampco Tune-Up Kit. Kits to fit all  
Ford, GM and Chrysler Corp. cars.

YOUR CHOICE

**\$1.47**



## PORTA-DESK

Mobile Office for your pickup or  
car. Provides a firm writing sur-  
face. 12" x 15" top has clip to  
hold papers, holder for pencil. In-  
terior has fourty iron filing com-  
partment for standard size files  
notebooks.

SALE PRICE

REG. 29.95

**\$26.95**

PRESSURIZED  
DRY CHEMICAL

## FIRE EXTINGUISHER

2 1/2 pounds, with Universal bracket  
ideal for home, workshop and auto.  
Approved by UL and FM. Unit has  
pressure gauge.

SPECIAL

**\$5.97**



MODEL 275R

## EMERGENCY TOW ROPE



BREAKING STRENGTH  
6,500 LBS.  
12 Foot Cut Length

SPECIAL

**\$4.95**

**GEBOS**

# GEBO'S



## 1975 - 1976 FIELD SPRAYER CATALOG

SAVE THIS CATALOG  
FOR FUTURE  
REFERENCE



PRICES GOOD AT ALL GEBO'S STORES

PLAINVIEW, TX.  
426 Ash Street

HEREFORD, TX.  
230 No. 25 Mile Ave.

LITTLEFIELD, TX.  
508 Hall Ave.

LUBBOCK, TX.  
50th & Ave. A

AMARILLO, TX.  
2500 E. Third St.

ENNIS, TX.  
Old Hwy. 75 S.

HILLSBORO, TX.  
Hwy. 77 South

BROWNFIELD, TX.  
1604 Lubbock Rd.

CLOVIS, N.M.  
101 N. Sycamore St.

LAMESA, TX.  
208 S. Dallas

DALHART, TX.  
101 Denrock

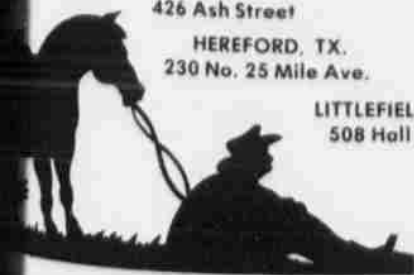

December 10

and gave 24 - 31 percent. Dark reductions were assigned to 18 percent of the

discuss use of IMCA Management Orientation Program for 2000

the bench to do good

# THE *green* LINE

## FIELD AND PASTURE SPRAYERS

### 300 GALLON—3 POINT—8 ROW SPRAYER

Heavy 14 gauge full length saddle. Saddle sump flared for tank protection. Adjustable parking stand. Adjustable regulator stand. High clearance for implement tongue. Fits category two 3 point hitch. 8-row, 3 section, 28 ft boom square tube design prevents nozzles turning. Each section center fed for uniform spray application. Adjustable nozzle spacing. Spring loaded, 4-way boom hinge. Large 1/2" boom hose for uniform application. Adjustable boom height. Long wearing nylon 20 GPA fan tips. Ropes to fold boom from tractor seat. Snyder ribbed polyethylene tank with 10" top opening, two fittings, sump for complete drainage.

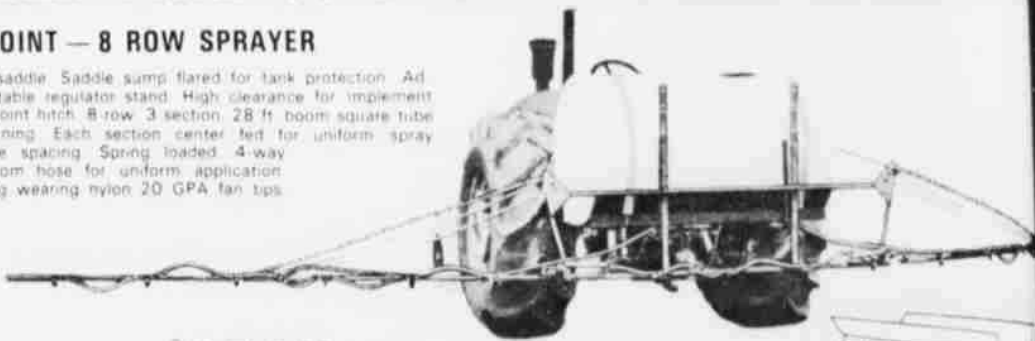

**GEBO'S PRICE**  
**LESS PUMP** .....

**\$646<sup>00</sup>**

### 400 OR 500 GALLON SKID MOUNT PASTURE SPRAYER OR NURSE TANK

Carries 400 or 500 gallon 48" tank. Rugged all welded construction, factory assembled. Heavy 14 gauge full length saddle with flared sump opening for tank protection. Engine Pump Unit is 4 h.p. with cast iron 6-rotor pump (GLS-8E6R). Square tube, 3-section 28 ft, 8-row boom. Non-corrosive, 1/2" hose boom with adjustable nozzle spacing. Each section fed at center for uniform application. Spring loaded, 4-way boom hinge; long wearing nylon 20 GPA fan tips. Snyder, ribbed polyethylene tank with 10" top opening, two fittings, sump for complete drainage. Less suction line and strainer.

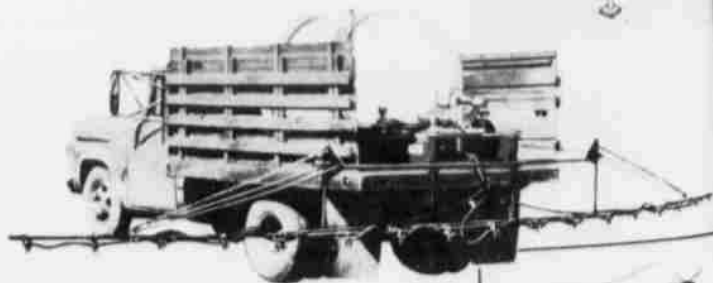

### 500 GALLON PASTURE SPRAYER

**GEBO'S PRICE** .....

**\$881<sup>95</sup>**

### 500 GALLON NURSE TANK

Same as above less boom and pump unit. **GEBO'S PRICE** .....

**\$453<sup>95</sup>**

### 4 H.P. 2 PISTON PUMP UNIT

400 g.p.s. at 6 gal. per minute.

**GEBO'S PRICE** .....

**\$338<sup>00</sup>**

### 200 GALLON—3 POINT—8 ROW SPRAYER

Heavy 14 gauge saddle with sump opening flared to protect tank. All welded assembly with rugged built-in parking stand. Adjustable regulator stand. Fits category two 3 point hitch. Hoses, fittings and strainers sized to take full advantage of pump capacity. 8-way dial regulator for separate control to each boom section. Square tube, 3-section 28 ft 8-row boom. Non-corrosive, 1/2" hose boom with adjustable nozzle spacing. Each section fed at center for uniform application. Spring loaded, 4-way boom hinge; long wearing nylon 20 GPA fan tips. Snyder, ribbed polyethylene tank with 10" top opening, two fittings, sump for complete drainage.

**GEBO'S PRICE**  
**LESS PUMP** .....

**\$574<sup>00</sup>**

# GEBO'S



# PRE-EMERGENCE

applies at once, spray while planting or while working the soil. One of the two pre-emergence kits shown below, when mounted on a front mounted or 3 point rear mounted tank. Choose the one to fit your operation.

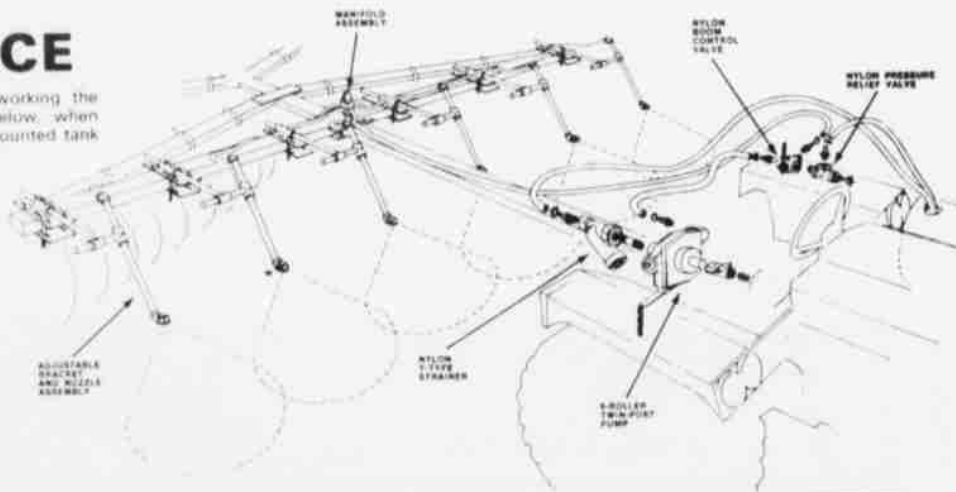

## DELAVAN SPRAYER KITS FOR HERBICIDE INCORPORATION

Mounted on a disc or spring tooth cultivator, application and incorporation of the herbicides is accomplished in one operation. Bracket and nozzle assembly adjusts for reach in front of frame, angle of spray and for spraying height. Manifold and nozzles distribute pressurized liquid equally. Kit includes two sets of nozzles (No. 44 and No. WRW-10), pressure relief and boom valves, pressure gauge, all hoses, clamps and fittings.

Kit with 4 Nozzle  
 18 to 22" nozzle  
**GEBO'S PRICE** ..... **\$198.50**  
 LESS PUMP

Kit with 6 Nozzle Kit  
 18 to 22" nozzle  
**GEBO'S PRICE** ..... **\$236.50**  
 LESS PUMP

## BOOM ASSEMBLY

Three section boom. Large 1/2" hose with adjustable nozzle spacing. Each section center fed for uniform application. Spring loaded, 4-way boom hinge. Long boom nylon 20 GPA tips. Ropes to fold boom from transport. All hoses and parts sized to take full advantage of pump capacity. 8-way dial regulator. Separate control for each boom section.

1 Row Boom  
**GEBO'S PRICE** ..... **\$174.00**

2 Row Boom  
**GEBO'S PRICE** ..... **\$225.00**

### GREEN-LINE PLANTER KIT

- Use one planter kit for each two rows.
- Fits most planters and listers.
- Adjustable for 8" to 14" band.
- Includes 10 gallon per acre Even Spray tips.
- Large 1/2" hoses and fittings.

**GEBO'S PRICE**  
**\$24<sup>95</sup>**



## DELAVAN SPRAY GUN KIT

Use for orchard spraying, crop or fence row spraying, insect control and cleaning machinery or outbuildings. Complete with hoses and all necessary parts.

**GEBO'S PRICE** ..... **\$55.95**  
 Less Pump Assembly

## GREEN-LINE 14 FT. DISC KIT

Includes four D5 nylon flood tips, for 40" spacing for 21 GPA at 5 MPH. Large 1/2" hoses, fittings. Carried low to ground for minimum spray drift. Because of large tip openings and no tip screens, plugging is kept to a minimum. Fits most disc, rolling plows, minimum tillage equipment.

**Disc Kit** ..... **\$41.25**  
 3/4 Ft. Extension **\$11.50**

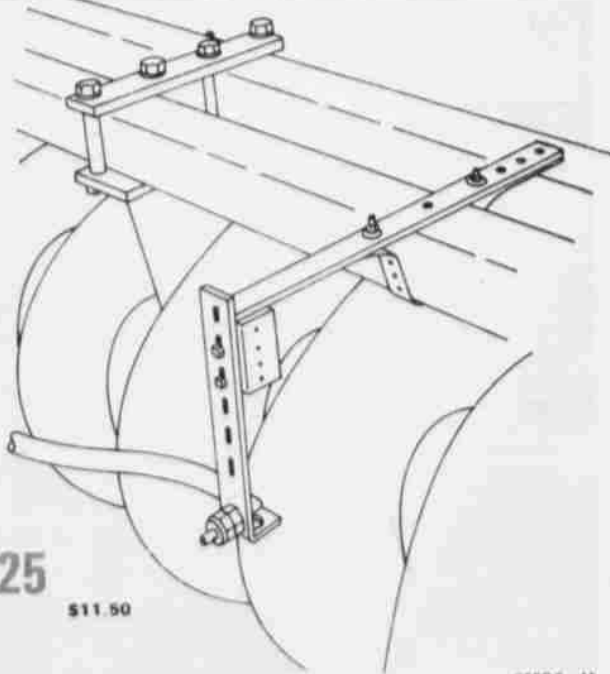

GEBO'S-18

**R**  
 AY, DEC  
**s In**  
 In Toyla  
 ill be ton  
 High Scho  
 mission w  
 ents for c  
 is being s  
 ith Pat M  
  
 n the 3 ar  
 nnifer Di  
 s. W. A  
 ighter of  
 ; Rebec  
 ir, and I  
 Stueart,  
 Danny  
 ighter of  
 Shannon  
 Mr. a  
 Maxfield  
  
**C**  
**er**  
 id Wil  
 the "n  
 night  
 Mulesh  
 and R  
 ting as  
  
 scored  
 npton  
 for L  
 ith 6, F  
 ad 2.  
 will b  
 break  
 in the  
 reduced  
 at 2:3  
  
 about  
 ch De  
 this  
 ad 8 o  
 nd mu  
 t attri  
 good  
 in ou  
 nd in  
 Perr

December 10  
 some groups to 17 percent. Dark reductions were assigned to 18 percent of the

discuss use of IMCA Management Orientation Program for City Internal

the bench to do good j  
 The varsity girls def



# THE *green* LINE

## PRE-PLANT AND PRE-EMERGENCE SPRAYERS



### 200 GAL. SIDE MOUNT

Two 200 gal Snyder Ribbed polyethylene tanks with 10" top opening, two fittings in sump. Tractor engine accessible. Low for easy filling. Low profile for visibility. Includes heavy 14 gauge full length saddles with flared sump opening for tank protection and tank straps. All hoses and parts sized to take full advantage of pump capacity.

**GEBO'S PRICE**

**\$664<sup>70</sup>**

(Less Pump & Boom)

Extra cost option — planter and disc kits. Some models of Case and Massey Ferguson require additional mounting bracket.

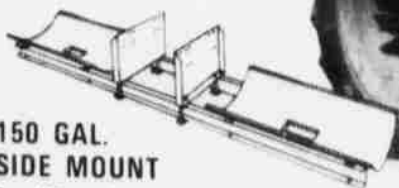

### 150 GAL. SIDE MOUNT

Two 150 gal Snyder Ribbed polyethylene tanks with 10" top opening, two fittings in sump. Tractor engine accessible. Low for easy filling. Low profile for visibility. Includes heavy 14 gauge full length saddles with flared sump opening for tank protection and tank straps. All hoses and parts sized to take full advantage of pump capacity.

**GEBO'S PRICE**

**\$557<sup>60</sup>**

(Less Pump & Boom)

Extra cost options — planter and disc kits. Some models of Case and Massey Ferguson require additional mounting bracket.



## FRONT MOUNT SPRAYERS 150 OR 200 GALLON

Heavy full length saddle with sump opening flared for tank protection. Brackets to mount 8 row boom. Ribbed Snyder polyethylene tank with two fittings in sump. All hoses and parts size to take full advantage of pump capacity.

150 GAL RIG  
(LESS PUMP)

**GEBO'S PRICE**

**\$330<sup>90</sup>**

200 GAL RIG  
(LESS PUMP)

**GEBO'S PRICE**

**\$347<sup>95</sup>**

Extra cost options — 8 row boom

**\$174.00**

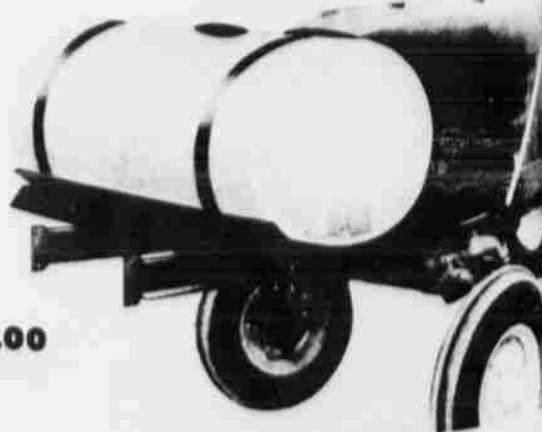

# GEBO'S

## YOUR COMPLETE SPRAYER HEADQUARTERS



200 or 300  
GALLON RIG

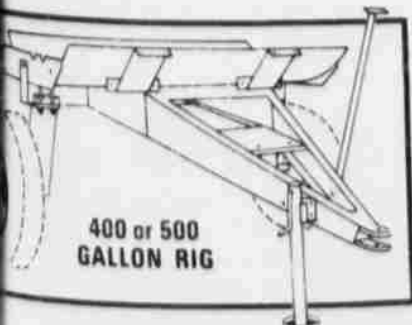

400 or 500  
GALLON RIG

### 200 or 300 GALLON 8-ROW SPRAYER

Carries (200 gal.) or (300 gal.) 38" tank. Heavy 14 gauge, full length saddle with flared sump opening to protect tank. Platform in tongue for step or mounting pump. Wheels adjustable 60 to 84 inches. 1 1/2 inch 4-bolt wheels. Timken bearings. Front parking stand. Adjustable regulator stand. Snyder, Ribbed polyethylene tanks with 10" top opening, two fittings. Sump for complete tank draining. Square tube, 3-section 28 ft. 8-row boom. Large 1/2" hose with adjustable nozzle spacing.

200 Gal. Rig Less  
Pump and Tires  
GEBO'S PRICE

**\$699<sup>00</sup>**

300 Gal. Rig Less  
Pump and Tires  
GEBO'S PRICE

**\$754<sup>95</sup>**

\$11.75

Extra Cost Options: GLS-14 Bracket to Front Mount Boom.

### 400 or 500 GALLON 8-ROW SPRAYER

Carries (400 gal. or 500 gal.) 48" tank. Heavy 14 gauge, full length saddle with flared sump opening to protect tank. Platform in tongue for step or mounting pump. Wheels adjustable 57 to 84 inches for 9.50 or 11L 15 tires. Timken bearings. Crank type parking stand. Adjustable regulator stand. Snyder, ribbed polyethylene tank with 10" top opening, two fittings. Sump for complete tank draining. Square tube, 3-section 28 ft. 8-row boom. Large 1/2" hose boom with adjustable nozzle spacing.

500 Gal. Rig Less Pump  
and Tires  
GEBO'S PRICE

**\$1024<sup>00</sup>**

Extra Cost Option: 10 Row Boom **\$225.00**

...percent. Dark reduc-  
tions were assigned to 18 percent of the

discuss use of IMCA Management  
Orientation Program for City Internal

the bench to do good  
The varsity girls

**WEAR ON TIPS FROM ABRASION CAUSES —**  
Crop losses. Chemical waste. Uneven distribution.  
Frequent tank refilling.

Nozzle tips tested with wettable powder showed that discharge of brass tips increased 13 per cent in 30 hours of use, stainless steel 6.7 per cent, nylon 4.9 per cent. If chemical cost \$7 an acre, 10 per cent over dosage would cost \$105.00 on 150 acres sprayed, to which should be added another 7.35 for interest, so the user would be out \$112.35. He could have saved this by installing new nozzle tips which would have cost him \$8.54 for 13 brass tips. Nozzle tip wear also changes the spray pattern, causing skips and poor coverage. Overdosage, mentioned before, not only wastes chemical but can be harmful to the crop. Pressure alone can cause wear even with clear water. Stainless steel and nylon can outwear brass at least 4 to 1.

DELAVAN

**SPRAY NOZZLES**

FLAT SPRAY — FOR BROADCASTING		
Material	No. in Pack	PRICE Per Pack
Brass	4	\$ 2.64
Brass	13	8.54
Brass	6	3.94
Nylon	4	4.86
Nylon	13	16.79
Nylon	6	7.50
Stainless Steel	4	7.92
Stainless Steel	13	25.74
Stainless Steel	6	11.95

FLOODING TIPS — FOR BROADCASTING		
Material	No. in Pack	PRICE Per Pack
Brass	6	\$ 6.21
Stainless Steel	6	14.04

EVEN SPRAY — FOR BANDING		
Material	No. in Pack	PRICE Per Pack
Brass	4	2.63
Brass	13	8.54
Brass	6	3.94

CONE TIPS — FOR INSECTICIDES		
Material	No. in Pack	PRICE Per Pack
Brass	4	3.42
Brass	8	7.56
Brass	13	11.11



**STANDARD NOZZLE CAPS**

Brass 4 Pack	\$1.15
Brass 6 Pack	\$1.70
Nylon 4 Pack	\$ .90
Nylon 6 Pack	\$1.34

**NOZZLE STRAINERS**

Brass 8 Pack	\$4.32
Brass 6 Pack	\$3.24
Nylon 8 Pack	\$3.74
Nylon 6 Pack	\$2.80

**NOZZLE BODIES**

1/4" Brass 4 Pack	\$1.98
1/4" Brass 6 Pack	\$2.98

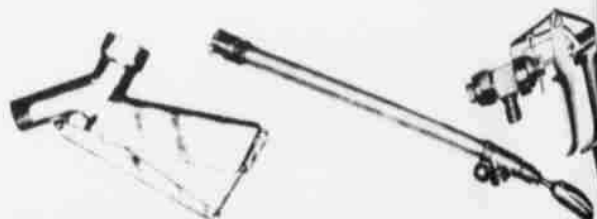

**DELAVAN** NO. 1 IN SPRAYING ACCESSORIES FOR QUALITY AND PRICE.

24" ALUMINUM SPRAY GUN ..... \$1  
TRIGGER ADAPTER ..... \$1  
TRIGGER SPRAY GUN ..... \$1



**3/4" PRESSURE RELIEF VALVE**

Aluminum 0-250 lbs. GEB'S PRICE \$7.88  
Nylon 0-400 lbs. GEB'S PRICE \$7.92

**NYLON "Y" LINE STRAINER**

3/4" or 1" 3/4" Hose Barb Suction Strainer



**2" PRESSURE GAUGE**

100 P.S.I. GEB'S PRICE

\$2.79

**18 INCH NOZZLE DROP**

For Single or Double Nozzle Head

GEB'S PRICE

\$3.97 - EA.



**1/4 INCH SINGLE SWIVEL NOZZLE BODY**

BRASS — 2 PACK GEB'S PRICE

\$4.91

NYLON — 2 PACK GEB'S PRICE

\$3.80



**RAINDROP NOZZLES**

This new nozzle was designed to produce a hollow cone pattern with droplets that are significantly larger than those produced by conventional nozzles at comparable pressures and flow rates.

In this latest concept of low-drift spraying, the nozzle does all the work... no additives are required.

**STAINLESS STEEL RAINDROP NOZZLES**

**\$3.10 EACH**

Elegant Velvet!

Made of solid Delavan machinery!

# GEBOS

COMPLETE FIELD SPRAYER HEADQUARTERS!

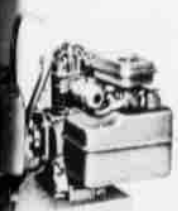

PORTABLE - CENTRIFUGAL

## TRANSFER PUMP

GEBOS PRICE

**\$164.95**

chemicals, liquid fertilizer, or water. 2" inlet-outlet, self-priming 4 cycle engine. Pumps up to 7200 GPH.



## BOOM JET NOZZLE

Jet Nozzle for mounting at rear of tractor. Either side may be blanked out for right or left hand spraying. Covers 40' - 50' area.

GEBOS PRICE

**\$32.95**

1/2" SINGLE NYLON  
No. 64965  
GEBOS PRICE

## DIRECTO VALVE

**\$9.95**

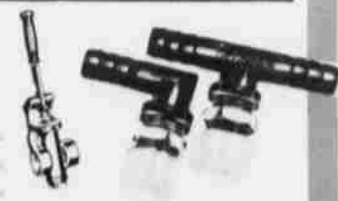

86"  
86"  
23"

No. 805054 T barb body  
No. 805055 L barb body  
No. 805148 Nut for barb body

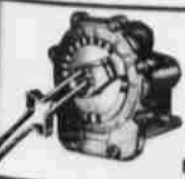

## 8 WAY CONTROL VALVE

3/4" side & 1/2" Rear Ports  
GEBOS PRICE

**\$24.95**

No. 606237

## HI-PRESSURE PUMP

GLS-8-EP6 Perfect for hand-gun and cattle spray. 4 HP engine, 8 roller cast iron pump. 3/4" ports. Maximum 250 PSI or 9.5 GPM flow.

GEBOS PRICE

**\$254.00**

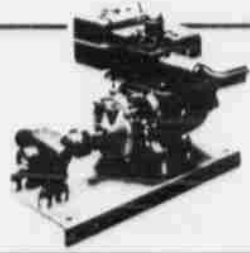

## HEAVY DUTY LAY-IN SADDLES

- Heavy 14-gauge full length saddle
- Flared sump opening for tank protection
- Edges turned out to protect tank

For 32" Tanks ..... **\$29.95**

For 38" Tanks ..... **\$39.90**

## REPLACEMENT TANK STRAPS

- Tank Strap for 32" tank **\$5.19 Ea.**
- Tank Strap for 38" tank **\$6.95 Ea.**
- Tank Strap for 48" tank **\$12.90 Ea.**

## SAVE ON BULK HOSE



2 Ply

2 Braid Pressure Hose For Application Of Pesticides, Insecticides and Fertilizers.

Inside Diameter	Working Pressure	Price Per Ft.
3/8"	250 psi	<b>\$ .41</b>
1/2"	250 psi	<b>.49</b>
3/4"	200 psi	<b>.67</b>
1"	200 psi	<b>.95</b>
1-1/4"	150 psi	<b>1.63</b>
1-1/2"	150 psi	<b>1.83</b>

EVA is a specially compounded hose that doesn't require textile reinforcement, will not crack, separate, or harden, even at freezing temperatures. Ideal for anhydrous ammonia and liquid fertilizer operations. Also handles LASSO.

3/8"	75 psi	<b>\$ .19</b>
1/2"	75 psi	<b>.29</b>

## CLEAR VINYL SIGHT GAUGE TUBING

3/8"	45 psi	<b>.19</b>
1/2"	45 psi	<b>.20</b>
3/4"	45 psi	<b>.38</b>
1"	35 ps	<b>.49</b>



DELAVAN

## JET AGITATOR

No. 25467 Provides maximum agitation to keep wetttable powders in suspension. Variable spring-loaded orifice maintains constant velocity regardless of the amount of liquid being bypassed. Connects directly to bypass line. Venturis increase liquid volume two and one half times.

GEBOS PRICE

**\$4.50**



HYPRO

## JET AGITATOR

(Similar to illustration)

Provides Vigorous Agitation For Wetttable Powders

No. 608275  
GEBOS PRICE

**\$4.45**

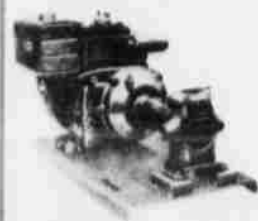

## 2 PISTON PUMP

GLS-8-EP6 4 H.P., 2-piston pump to 400 PSI, 8 GPM flow 3/4" NPT parts.

GEBOS PRICE

**\$338.00**

# GEBOS



# GEBO'S YOUR FIELD SPRAYER HEADQUARTERS!

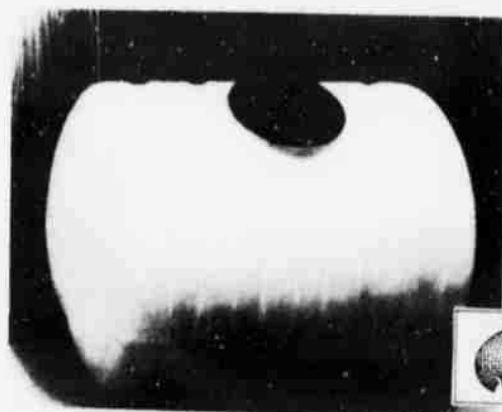

## POLYETHYLENE AGRI-TANKS

Horizontal rib design for greater strength. Readable sight gauge. Large 10" NPT opening with 4" recess into the tank. Sump for complete drainage but shallow enough to prevent settling of wettable powders during correct agitation. Superior materials, the high density polyethylene materials have proved to be considerably stronger for tank construction than the materials used in competitive poly tanks. Durability to ultra-violet rays — in addition to an ultra-violet inhibitor added to the polyethylene materials, the green translucent coating provides extra protection against deterioration from the sun's rays. Two year warranty on defects in material and workmanship.

- 150 Gal. 32 Inch
- 200 Gal. 32 Inch
- 200 Gal. 38 Inch
- 300 Gal. 38 Inch
- 500 Gal. 48 Inch

## CENTRIFUGAL & HYDRAULIC PUMPS...

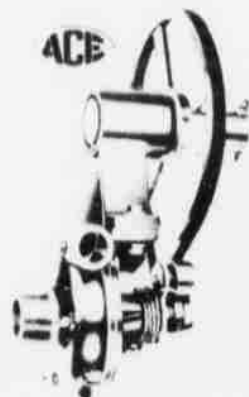

### ACE CENTRIFUGAL PUMPS

High Pressure Models with Belt Guards

PTOCH 600-10  
600 RPM

**\$123.00**

PTOCH 1000-10  
1000 RPM

**\$129.50**



### HYPRO ROLLER PUMP

C-6400 — 6-roller 1/2" NPT end ports 15/16" solid shaft Standard PTO adaptor

**GEBO'S PRICE**

**\$48.95**

With Quick Coupler



### HYDRAULIC DRIVEN CENTRIFUGAL PUMP

Frees PTO shaft for other operations. Convenient mounting flexibility for ideal plumbing arrangements. Vibration free operations. Compact size.

**GEBO'S PRICE**

**\$129.00**



GEBO'S PRICE

**\$69.50**

### DELAVAN TURBO 90 HI-VOLUME PUMP

Will run directly from 1000 RPM PTO and deliver high volume at low speed with no clogging. A new concept in turbine pumps designed specially for agricultural uses.



### DELAVAN ROLLER PUMPS

Precision Machined to exacting tolerances to assure premium performance and longer life. Large suction and discharge ports. Heavy-duty bearings assure longer life.

16 Roller Cast Iron Back Port — No. 60 3/10 inch quick coupler **\$28.95**

6 Roller Ni-Resist. Twin Ports No. 6-4110 (with quick coupler) **\$45.90**

7 Roller Cast Iron Side Port No. 27 3/10 (with quick coupler) **\$37.90**

7 Roller Ni-Resist. Twin Port No. 7-4110 (with quick coupler) **\$57.50**

7 Roller Ni-Resist. Side Port No. 7-3110 HP (with quick coupler) **\$39.95**

GEBO'S 20

## SAVE THIS 8-PAGE SPRAYER CATALOG FOR FUTURE REFERENCE

WE RESERVE THE RIGHT TO LIMIT QUANTITIES AND CORRECT PRINTING ERRORS. PRICES SUBJECT TO CHANGE WITHOUT NOTICE.



DIRECT DRIVE COUPLER  
**GEBO'S PRICE**

**\$7.25**



## BATTERY CHARGERS

6 AMP MODEL No. B-6612: Charges both 6-volt and 12-volt batteries. Charger is equipped with an automatic circuit breaker, selector switch for changing operation from one voltage to another and an accurate, numbered dial ammeter which shows the exact rate of charge entering the battery.

10 AMP MODEL No. B-6612: 2/3 greater charging capacity than the B-6612. Equipped with an automatic circuit breaker, selector switch for changing operation from one voltage to another and an accurate, numbered dial ammeter.

SALE PRICE... **\$17<sup>95</sup>**

SALE PRICE... **\$21<sup>95</sup>**



## BATTERY TESTER Or ANTI-FREEZE TESTER

YOUR CHOICE

**69<sup>c</sup>**

Test Your Anti-Freeze, Hot or Cold

## STORALL PICKUP TRUCK UTILITY BOXES

THE GREAT WHITE BOX LINE  
Totally new behind-the-cab models

- Low silhouette design, yet more cubic inches than formerly
- Skin Seal design prevents trapped dust and water
- Aluminum rugged 7 mil
- Positive push button lock
- Unique Double-Door one-piece construction

FITS WIDE, NARROW BED AND IMPORT  
No. 11, 12, 13 Crossover

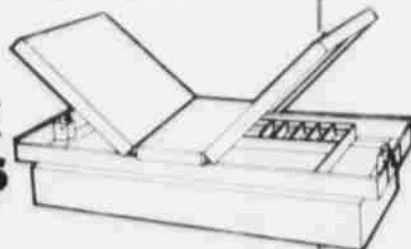

REG. 89.95

**\$79<sup>95</sup>**

## SERC STARTING FLUID

11 OZ. CAN



**79<sup>c</sup>**



## CHAMPION SPARK PLUGS

GEBO'S EVERYDAY LOW PRICE

**64<sup>c</sup>**

RESISTORS AND SPECIALTY PLUGS SLIGHTLY HIGHER

HEAVY DUTY CAROL

## BOOSTER CABLES

USE AROUND HOME, FARM, WORK

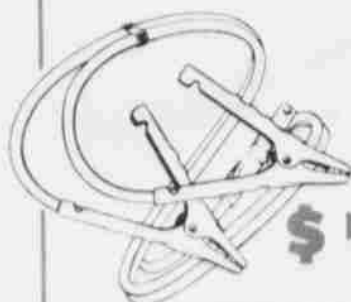

ST 144  
4 GA.  
400 AMP CLAMPS

**\$13<sup>95</sup>**

**GEBO'S**

## NEW GIFT IDEA

FROM  
VISE-GRIP



### GEBO'S SPECIAL

**\$5<sup>88</sup>**



FOR HIM



### TRUECRAFT 14-PIECE 1/2" DRIVE SOCKET SET

No. G314C. 10 standard sockets, spark plug socket. Reversible Ratchet handle. 15-1/2" Flex Handle. 5" Extension.

SPECIAL .....

**\$15<sup>98</sup>**

### JIG SAW



Reg. \$13.49  
SPECIAL

**\$11<sup>97</sup>**

No. 7504. Unbreakable housing. Makes straight, curved and scroll cuts in wood, metal, plastic and other materials. This low cost, versatile time-saver does innumerable jobs around the home and in the workshop. Double insulated. Burn-out protected motor. Includes wood cutting blade.

## Black & Decker

#7414 1/2 SHEET  
FINISHING SANDER



Large 4-1/2" x 11" sanding surface. Gets jobs done faster, easier. Orbital action for fast material removal. Double insulated.

**\$18<sup>99</sup>**

SPECIAL .....

### #7310 7/4" SAW

Burnout protected motor. Handle placement gives excellent balance and control. 7/4" combination blade included. Sawdust ejection chute keeps sawdust away from cutting line.

REG.  
39.99 .....

**\$29<sup>95</sup>**

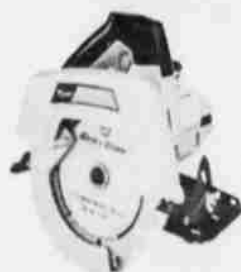

### #7301 7/4" CIRCULAR SAW

1 HP Motor. Outstanding value in a general purpose saw.

REG.  
27.99 .....

**\$23<sup>97</sup>**

### #7104 3/8" DRILL UNBREAKABLE HOUSING

Great general-purpose drill for most homeowner and workshop use. Double reduction gear system delivers high power drilling action. Well balanced, comfortable to use. Double insulation. Recessed center locking button prevents accidental "lock-on."

Regular  
\$13.49

**\$11<sup>97</sup>**



### #7204 1/2" COMPACT DRILL

Compact, lightweight drill has triple reduction gearing for torque. Burn-out protected motor. Removable side handle for added control. Double insulation means safety without grounding and the convenience of a two-prong plug. Recessed center locking button prevents accidental "lock-on."

REG.  
24.99

**\$22<sup>77</sup>**



### #7530 VALUE-PLUS™ GEBO'S PRICE TWO-SPEED JIG SAW

**\$14<sup>99</sup>**

1/3 HP (max. motor output). Pick the speed to suit the job. High speed for wood and compositions, low speed for metal and plastic. Calibrated tilting shoe for making bevel and compound mitre cut. Double insulated.



GEBO'S



3-AA ALL DISTRICT

# Olton, Littlefield Dominate Honor Team

TURNER NAMED TO FOUR POSITIONS

et champion Olton and runner- field completely dominated the for District 3-AA All District as they combined for 20 of the 28 field's do-everything player, Bill was named to the elite team in positions, including three us choices. Turner made the a running back, safety, kicker ter. ly other Wildcat player to earn an one position was Steve Cruz was named as a running back

and as a linebacker.

Other Wildcats to make the team include Larry McDonald as an offensive lineman, Jimmy Durham as a corner back, Rick Hopping at a defensive lineman position and Randy Hall at a defensive line position.

All the Wildcat players to make the team are seniors.

Olton players on the star-studded team include Jimmy Parker at quarterback, Glen Johnson at running back and linebacker, Michael Franks and

Mark Stroebel at ends with Stroebel also listed as a safety, J. D. Caudle and Kent Pittillo at offensive lineman positions, Kevin Workman at a corner back position and Ray Rodriguez at a defensive lineman position.

All of Olton's selections are also seniors.

Friona and Dimmitt had three members each make the team while Morton had two.

The entire District 3-AA All District Teams is listed on page 10 of this issue.



STEVE CRUZ  
OFFENSE AND DEFENSE



JIMMY DURHAM  
DEFENSE



RANDY HALL  
DEFENSE



RICK HOPPING  
DEFENSE



LARRY McDONALD  
OFFENSE



BILL TURNER  
FOUR POSITIONS

GUSTS TO 60 MPH

## Wind Damage Reported Over Area

winds played havoc Saturday, sports coming in of street signs and Christmas decorations blown cotton trailers by the score were med. Winds fanned a small burr the Olton Farmers Co-op Gin out and for a time fire threatened and an unknown number of and loaded cotton trailers on the fire started early in the day

and units were still on the scene at midnight. The burrs were still on fire and a possible hazzard through Monday.

At Sudan Saturday morning winds caused so much damage that there were false reports that a tornado had hit the area. Tin from barns was stripped off, trees were toppled over, and trailers were overturned. To the east of this area numerous counties were put under a

tornado watch.

At Amherst, tin was torn off the drive-in theatre and scattered over Highway 37.

An unknown amount of damage was done to the unharvested cotton. Blowing tumble weeds and high winds blew cotton out of the burrs, and cotton not blown out was filled with dirt which will lower the grade considerably.

**SUNFIGHTER**  
Fights Sun in Summer and Ice in Winter

- Classic appearance
- Mounts outside the hood
- Does not affect fuel box or bay tank installation
- Sun deflectors are welded at every point on a permanent angle
- Four vehicle rods to prevent vibrations

Regular 76.50 **\$66.66**

MAJOR BRAND MOTOR OIL

Description	Qt.	Case
Pennzoil 30	5.63	\$12.88
Pennzoil 20W40	7.1	13.90
Havoline 30	6.6	13.30
Havoline 10W40	8.3	16.75
Quaker State	7.2	14.49
Amalie Reg. 30	6.3	12.80
Amalie HD30	6.3	12.86
Gulf Single G30	7.2	14.49
Gulf Multi G	7.9	15.90

**Kennedy TOOL BOXES**  
**\$11.97**

The Kennedy K-20  
An ideal box for the tradesman and do-it-yourselfer who wants a deep box for bulky hand tools and a tray for smaller items. Like all Kennedy heavy-duty tool boxes, it has a full-length lid hinge with stakes-in stainless steel pin for added strength. Rigidly and securely plated locking hardware, latches and carrying handle.

**SPECIAL!**

**WIX FILTERS**  
EXTRA BIG  
**10% OFF**  
Regular Low Prices

**TOW CHAINS**  
by Fehr

SPECIAL

15/64 x 12 ..... \$ 5.49  
5/16 x 14 ..... 9.97  
3/8 x 14 ..... 13.95

**MEDALLION Battery Terminal CLEANER**  
**99¢**

**TRUECRAFT**

**11-PC. COMBINATION WRENCH SET**  
No. B011R  
Sizes 3/8" to 1"  
SPECIAL **\$15.98**

**WD 40**

No. 17-40. Penetrates, Lubricates, Displaces Moisture, Prevents Rust, Protects Metal Surfaces, Cleans, Removes Grease, Wax, Tar, Gum, and Other Deposits.

SALE PRICE **\$1.14**

**DUREX ANTI-FREEZE**  
GALLON  
**\$3.60**

**Capture er Win**

ld Wildcats remained the '75-76 basketball night as they defeated Muleshoe Mules, 62-53, and Richard Rogers led ting as they each tossed

scored 11 for Littlefield nton had 10.

for Littlefield include ith 6, Rudy Ayala with 5 ad 2.

will be out to extend reak this weekend as in the Kress Tourney, eduled to play Hale at 2:30 p.m. in opening

about the 'Cats fifth ch Dee Blevins stated this win was a great ad 8 or 9 players do an d much of our success attributed to the fact good bench strength in outstanding game nd in rebounding and Perrin both came off the bench to do good jobs for us."

The varsity girls defeated Muleshoe, 54-48.

Monica Phillips scored 33 big points in the victory and had scoring help from Pennie Sexton with 12 points, Rhonda Hollingshead with 5 and Carol Sexton tossed in 4.

The girls will be in the Kress Tourney this weekend also and they are

# NEWS 15 CENTS

AY, DEC. 4, 1975 10 PAGES

## ... In Toyland Pageant Unfurls Friday Night

In Toyland" pageant for ill be tomorrow, Friday, High School Auditorium at mission will be \$1.50 for ents for children under 12. is being sponsored by We, ith Pat Marcum serving

in the 3 and 4 year-old age nifer Dillen, 3, daughter s. W. A. Dillen; Kristy ighter of Mr. and Mrs. ; Rebecca Denton, 3, r. and Mrs. Jerry Don Stueart, 3, daughter of Danny Stueart; Shelly ghter of Mr. and Mrs. Shannon Renee Warren, Mr. and Mrs. Wade Maxfield, 4, daughter of

Mr. and Mrs. Sammy Maxfield; Monica Patterson, 4, daughter of Mr. and Mrs. Carrell Patterson; Jennifer Jones, 4, daughter of Mr. and Mrs. Troy Jones; Kelli Kloiber, 4, daughter of Mr. and Mrs. Kim Kloiber; and Cheryl Serratt, 4, daughter of Mrs. Carol Serratt.

Contestants in the 5 and 6 year-old age groups are: Staci Birkelbach, 5, daughter of Mr. and Mrs. Randy Birkelbach; Letitia Trimmer, 5, daughter of Mr. and Mrs. Eddie Trimmer; Angie Stueart, 5, daughter of Mr. and Mrs. Danny Stueart; Mitzi McLelland, 6, daughter of Mr. and Mrs. Arthur McLelland; Tammy Reed, 6, daughter of Mr. and Mrs. T. J. Reed; Melissa Kelton, 6, daughter of Mr. and Mrs. Dale Kelton; Shannon Crews, 6, daughter of Mr. and Mrs. Mike Crews; and Carrie Lynn Sawyer, 5, daughter of

Mr. and Mrs. Chet Sawyer.

In the 7 and 8 year-old category contestants entered are: Leslie Ann Warren, 7, daughter of Mr. and Mrs. Wade Warren; Dawnna Denton, 7, daughter of Mr. and Mrs. Jerry Don Denton; Michelle Jones, 7, daughter of Mr. and Mrs. David Jones; Teresa Baily, 8, daughter of Mr. and Mrs. Kenneth Bailey; and Shawnda Masten, 8, daughter of Mr. and Mrs. Danny Masten.

Presenting the 1975-76 winners will be last year's winners, Tiffany Page Simpson, daughter of Mr. and Mrs. Arlen Simpson; and Deanna Jones, daughter of Mr. and Mrs. David Jones.

Contestants are rehearsing tonight at 7 o'clock.

See photos of the contestants in this issue of the paper.



LONGIE TWITTY gets high off the floor to battle for the rebound in Littlefield's victory over Muleshoe Tuesday night. Twitty scored 14 points in the contest as did Richard Rogers to lead the 'Cats to the 62-53 win. It was Littlefield's fifth win of the season against no losses. Other Wildcats in double figures Tuesday include David Davis with 11 and Narva Simington with 10. Varsity teams will be in action this weekend in the Kress Tournament. (Staff Photo)

December 10

ewly elected Community ASC etemen will hold their Annual also in the Lamb County ASCS rom nine o'clock in the morning e a public meeting to elect or re- members to the County ASCS

reduction was 57 percent. Sample reductions were assigned to 18 percent of the samples classed.

Staples 29, 30 and 31 were predominate lengths. Staple 29 was 25 percent, staple 30 - 35 percent and staple 31 was 19 percent.

Mike readings 3.5 through 4.9 amounted to 13 percent of the total. Mike group 3.3 through 3.4 accounted for 11 percent, 3.0 through 3.2 range 34 percent, mike 2.7 through 2.9 was 27 per-

discuss use of IMCA Management Orientation Program for City Internal Training, discuss City Engineer drawing plans and specifications for water line extension to Littlefield Plaza and discuss the water and sewer extension policy.

The Council will also continue the discussion on the drilling permit requested by Texaco. No decision was reached Monday night at the public hearing.



Elegant Velvet!

# GEBO'S HOME OF THE FAMOUS DURALON TIRE



**MUD  
and  
SNOW**

PREMIUM\* MUD & SNOW

## STEEL BELTED RADIAL

Saw-tooth tread design to cut right through the deep. There's mud power to spare. Yet this exclusive tread design runs quiet even on dry turnpikes when going gets hot. It cuts a wide, deep swath for command contact with the driving surface.

SIZE	CAT. NO.	PRICE	EX. TAX
GR70-15	YFLUS	\$43.50	\$3.22
HR70-15	YFLU7	\$45.95	3.42
LR70-15	YFLVD	\$49.49	3.86



**DURALON**

## D.S. PREMIUM\*

FULL 4 PLY POLYESTER  
WHITE STRIPE TUBELESS

Premium Quality all the way. Full 13/32" tread depth. Carved tread composed of long mileage Polybutadiene compounds.

\*Premium is our designation. No industry standard exists for premium tires.

SIZE	CATALOG	SPECIAL	EX. TAX
E78-14	MB6L5	22.60	\$2.27
F78-14	MB6L7	23.40	2.40
G78-14	MB6L9	24.40	2.56
H78-14	MB6MB	25.98	2.77
G78-15	MB6VV	25.40	2.60
H78-15	MB6VX	26.60	2.83
J78-15	MB6V1	26.98	2.99
L78-15	MB6V3	27.75	3.11

### MUD & SNOW

## PREMIUM\* 78

- Tough 4 Ply Nylon Cord
- Fantastic Traction
- Outstanding Mileage
- Smooth, Quiet Ride

The Deep Cut Interlocking Tread Design Gives A Bulldog Grip To The Road. Premium Tread Depth For Long Mileage Nylon Cord For Strength & Durability.

		Sale Price	
G78-15	MB3VV	23.95	2.43
H78-15	MB3VX	25.49	2.82
L78-15	MB3V3	26.99	3.13

**NO TRADE-IN  
FREE MOUNTING**



## Batteries

### 12 VOLT AUTOMOTIVE

Grp. No.	Application	Ques	PRICE
22F-D36	Ford, Comet, Fairlane	36 Mo.	\$21.80
24F-D36	Ford Prod.	36 Mo.	22.40
24-D36	G.M. Chev's Corp. Rambler	36 Mo.	22.40
24-D48	G.M. Chev's Corp. Rambler	48 Mo.	26.30
27-D48	Chry's Corp. Buick, Olds, Cat	48 Mo.	30.95
27F-D48	Ford Products	48 Mo.	30.95
29N-D48	Ford Products	48 Mo.	25.25
60K-D48	Buick, Olds, Cat.	48 Mo.	29.40
42-D36	Volkswagen	36 Mo.	23.85
74RT	G.M. Side Terminal	36 Mo.	20.80

### 12 VOLT TRACTOR-TRUCK

Grp. No.	Application	Ques	PRICE
38T-DT36	M.A. J.D. I.H.C.	36 Mo.	32.70
B-D24	Oliver, I.H.C.	24 Mo.	85.50
24-D24	A.C. Case, I.H.C., Jeep, G.M.	24 Mo.	19.80
24F-D36	6000 Ford	36 Mo.	22.40
24-D36	A.C. Case, I.H.C., Jeep, G.M.	36 Mo.	22.40
24-D48	A.C. Case, I.H.C., Jeep, G.M.	48 Mo.	26.30
27-D48	A.C. Case, I.H.C., Jeep, G.M.	48 Mo.	30.95
29N-D48	Ford	36 Mo.	25.25
30H-DT24	A.C. Case	24 Mo.	41.25
60K-D48	Oliver	36 Mo.	29.40

### 6 VOLT TRACTOR-TRUCK

Grp. No.	Application	Ques	PRICE
10T24	Various Jeep, I.H.C., G.M.	24 Mo.	16.70
10T36	Various Jeep, I.H.C., G.M.	36 Mo.	20.30
10T48	Various Jeep, I.H.C., G.M.	48 Mo.	25.80
30T48	Various Jeep, I.H.C., G.M.	48 Mo.	25.80
40T48	J.D. I.H.C., Oliver	48 Mo.	34.95
50T24	Case, I.H.C., M.F., I.H.C.	24 Mo.	39.60
70T24	M.F., Oliver	24 Mo.	39.60
38HDT24	A.C. Case, I.H.C., M.F., Oliver	24 Mo.	45.45
48HDT24	I.H.C.	24 Mo.	33.95
48HDT24	I.H.C.	24 Mo.	41.95

### 8 VOLT

Grp. No.	Application	Ques	PRICE
10T8V	Various G.M., Dodge, Jeep	24 Mo.	22.95
20T8V	Various G.M., Dodge, Jeep	24 Mo.	26.40

Over 65% more start power than most original equipped batteries. Hi-torque, extra tall construction shortens power path 30%. Reduces wasteful internal resistance. 65% flinity of power for sure starts on even the largest engines. 5 Year Guarantee.

Grp. No.	Application	Ques	PRICE
24-880	Most Auto, Truck, Tractor	60 Mo.	32.95
24F-880	Ford Products	60 Mo.	32.95
27-880	Most Auto, Truck, Tractor	60 Mo.	36.80
27F-880	Ford Products	60 Mo.	36.80

ALL BATTERIES ARE  
PRICED PLUS EXCHANGE

**GEBO'S**

**GEBO'S**

the **Viking**

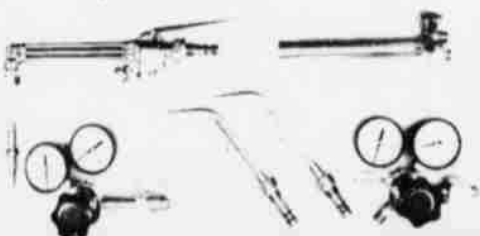

Welding and Cutting Outfit

Smith's

## WELDING & CUTTING OUTFIT

- Highly recommended for farms, repair shops, or professional pipe welders who demand high performance from a low cost outfit.
- "Slip-in" cutting and welding tips change quickly in just seconds... no wrench needed.
- Exclusive patented Flo-Trol<sup>®</sup> feature in cutting assembly provides extra safety.

ACCESSORIES included with outfit — 25" twin nose, goggles and torch lighter.

**\$109<sup>95</sup>**

REG. 117.95

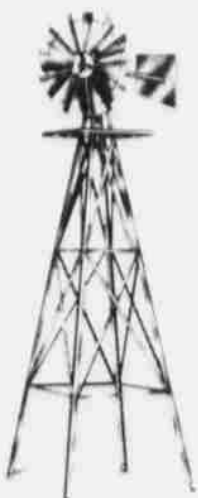

## 7' ORNAMENTAL WINDMILL

7 Ft. tall (tall enough to prevent children from reaching wheel). 22" diameter wheel. Replaceable ball bearings. Painted aluminum color. Can be used for: yard ornament, advertising purposes, mailbox holders, flower planters, climbing vine trellis, yard light holder and many other uses.

SPECIAL ..... **\$34<sup>95</sup>**

## 4" TRACTOR LIGHT

12 volt. Black baked enamel finish, heavy gauge steel body, and sealed beam unit. Universal mounting bracket.



**\$3<sup>49</sup>**

SALE PRICE.....

HANDY 8-1/2"

## CLAMP LIGHT

CLAMP AND REFLECTOR 6 FOOT CORD

**\$2<sup>29</sup>**

SALE PRICE.....

## MOTOROLA ALL WEATHER, SOLID STATE TRACTOR RADIO

No. TM107M. Not just another radio... it's engineered specifically for rugged, dependable outdoor performance to cope with weather conditions and tractor noise. Solid State circuitry for reliability. 5 1/2" x 7 1/2" speaker. Works on 6 or 12 volt operations, positive or negative ground. Jack for headphones.

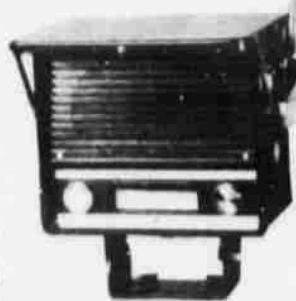

SALE PRICE

**\$67<sup>95</sup>**

LINCOLN WELDERS

LINCOLN

## 225 AMP WELDER

No. AC2255. Easy to operate. Dial type current selects welding currents from 40 to 225 amps in 12 steps. No cranking or loose plugs to fool with. Economical to own. No special wiring is needed. The average cost of using this machine is 3 to 5 cents per hour. Price includes accessory kit.

SALE PRICE

**\$119<sup>95</sup>**



**GEBOS**

# HYLO HARD HAT HEATER

70,000 to 14,000 BTU

Low Cost Spot Heater. Suitable for a multitude of jobs. Special Recirculating design burns clean. Hood diffuses heat over wide area. Built-in draft regulator and flame extinguishing damper. 10 gallon tank for 10-20 hours burning using kerosene, diesel No. 1 or 2 fuel oil. Stand included. Temporary or stand-by heat for indoor or outdoor service.

GEBO'S PRICE

**\$40<sup>95</sup>**

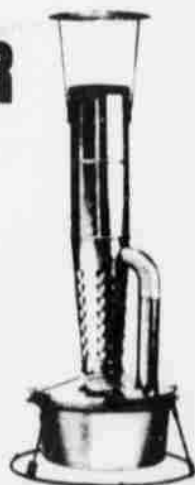

GREEN LINE  
60,000 BTU OIL FIRED

PORTABLE

## SPACE HEATER

No. 60PLB. Heats instantly. Burns Kerosene or No. 1 Fuel. Fan Circulated Air. For your protection clean, odor-free, heated air is circulated throughout the area. Use in barn, garage, work shops. Portable, easy rolling 8-inch wheels.

SALE PRICE **\$149<sup>95</sup>**

## NATIONAL RIVERSIDE RADIANT HEATER

100,000 BTU Infra-Red rays travel directly to people or objects anywhere around the heater. Works great in drafty or exposed work areas.

No. 100R  
(LP) SALE PRICE

**\$99<sup>00</sup>**

No. 100R-NG (Natural Gas)  
Hose Not Included - Reg.

**\$84<sup>95</sup>**



## EASY TO HANDLE REMINGTON MIGHTY MITE CHAIN SAW



Big 12" Cutting Bar

**6 1/2 LBS**

Light bar and chain

### EASY TO HANDLE, FUN TO USE

This 6 1/2 pound Mighty Mite Remington Chain Saw is so versatile you'll use it for:

- Felling trees up to 2 feet thick
- Cutting firewood
- Trimming, pruning, clearing
- Camping, summer homes
- Building outdoor furniture

Fully automatic chain oiling for smoother cutting, longer chain life. You'll like its low tone muffler, cushioned grips, and easy starting. Full assembled, ready to use. See it now.

2-YEAR WARRANTY  
GEBO'S PRICE

**\$114<sup>95</sup>**



(Exclusive 2-year Warranty)

## REMINGTON MIGHTY MITE - BANTAM CHAIN SAW

- 6 1/2 lbs. less bar and chain
- Cuts trees 20 inches thick
- Powerful 34cc engine
- Perfectly balanced
- Cushioned hand grip
- Quiet low-tone muffler
- Safe foot-brace starting

Why settle for an ordinary chain saw when you can get a full-featured Remington chain saw at this low price!

SAVE 10.00  
SPECIAL

**\$89<sup>95</sup>**

MAKE GEBO'S  
YOUR  
CHRISTMAS  
HEADQUARTERS

## STOCK TANK HEATER

- Thermostatic Control
- Maintains 30" Diameter Circle Free of Ice
- Water Tight - Rust and Corrosion Resistant
- 6 Foot Heavy Duty 3 Conductor Cord
- 1000 Watts

No. ST 1000. GEBO'S SPECIAL

**\$13<sup>88</sup>**

NOT AVAILABLE IN ENNIS OR HILLSBORO

## HEAT TAPES

KEEP WATER PIPES FROM FREEZING  
WITH OR WITHOUT THERMOSTAT

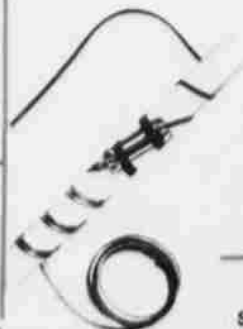

REGULAR (No Thermostat)

Size	GEBO'S PRICE
6'	1.75
12'	2.75
30'	3.25

AUTOMATIC THERMOSTAT

6'	2.25
12'	3.25
30'	4.25

COMPLETE SIZES FROM 4' to 60'

## PIPE INSULATION KIT

SALE PRICE **97<sup>95</sup>**

**GEBO'S**

# ROLL-A-CONE

HYDRAULIC

## ROW MARKERS

**FEATURES:**

- No center piece to interfere with planter boxes, etc.
- Simple design - reliability.
- May be supplied to fit any toolbar size.
- Lifts almost straight up to clear posts, etc.
- A special control orifice in each line makes numerous boom positions possible with ONE STANDARD AUXILIARY CONTROL VALVE ON TRACTOR.



G-1 SINGLE DIAMOND  
WT-65 LBS.

REG. \$119<sup>95</sup>  
227.75

REG. \$69<sup>95</sup>  
74.25

HIGH-QUALITY

## SHANKS

ALL MADE OF BEST  
HIGH CARBON STEEL

1" x 3" x 30" - WT. 25 LBS.  
REG. 13.50

\$9<sup>95</sup>



FOOTPIECE NOT  
INCLUDED

## ELECTRIC FENCE POST

3/8" x 4 REBAR 100 LOT

29<sup>c</sup> EACH \$26<sup>00</sup> EACH

## ELECTRIC FENCE WIRE

14 GA. 1/2 MI.  
AMERICAN MADE  
REG .....

\$16<sup>49</sup>

ARMCO

## 6-T POSTS

Designed for all-weather protection. Easy to install. Extra heavy anchor plate.

GEBO'S PRICE \$17<sup>99</sup>



HARVEST  
KING

## TRACTOR CABS

No. G-911. Big Side Door for ease of entry and dismounting. New tractor cab with reinforced steel top and frame, tinted tempered glass (side and back window slide in channel.) Lower cab is heavy duty water proofed, mildew resistant nylon. Fits any tractor with fenders.

GEBO'S PRICE \$322<sup>00</sup>

## The Durable Ones Built-to-last Doerr Stock Water Tanks.



Only Doerr has such deep corrugation and horizontal V-crimps to provide the strongest side wall possible. Heavy, 1-1/4" split tubing is riveted around top to prevent stock from bending tank. Bottom is lock-seamed and sweat soldered to prevent leaking.

SIZE TANK	GEBO'S
3 Foot .....	\$29.30
3 1/2 Foot .....	\$33.95
4 Foot .....	\$38.30
4 1/2 Foot .....	\$43.95
5 Foot .....	\$50.50
5 1/2 Foot .....	\$56.95
6 Foot .....	\$63.95
6 1/2 Foot .....	\$71.75
7 Foot .....	\$78.95
7 1/2 Foot .....	\$87.50
8 Foot .....	\$95.50
8 1/2 Foot .....	\$108.95
9 Foot .....	\$118.95
11 Foot .....	\$161.50

NOT AVAILABLE IN ENNIS AND HILLSBORO

GEBO'S





### FLASHLIGHT BATTERIES

Sealed in steel flashlight batteries in shrink file display pack.

SALE PRICE

**2 FOR 39¢**



### RADIO WAGON

No. 90. Heavy gauge steel, 40" x 15" x 10" semi-pneumatic tires. Large 14" x 15" x 4" body.

SALE PRICE

**\$15<sup>95</sup>**



### RADIO WAGON

No. 7. Safe-T-Handle. New all-terrain wheel design. Body: 20" x 10" x 11".

SALE PRICE

**\$5<sup>95</sup>**

RAY - O - VAC

## FLOURESCENT LANTERN

No. 3605 Sportsman Fluorescent Lantern. The most up-to-date general purpose outdoor lantern ever developed! Safe to operate, quiet state, low drain. Rugged, Waterproof, 3000 illumination. Complete with heavy duty batteries. Sug. Retail \$47.95.

SALE PRICE

**\$25<sup>95</sup>**

BURGESS DRY CELL

## BATTERY CHARGER

No. PNC 12C. Keeps toys going longer. Get \$1.00 or more from 25¢. Charges one to four at a time in any combination. Special 9 volt compartment for transistor batteries.

GEBO'S PRICE

**\$5<sup>97</sup>**



### TOOL MARKER

No. V-5001. Stop theft! Mark your valuables! Makes permanent marking on hardest steel, glass, plastic, stone, wood - most any hard surface. Operation-identification kit includes 2 window warning stickers and 10 "Stop Thief" labels for valuables.

SALE PRICE

**\$5<sup>99</sup>**

## Crosman POWERMASTER PELLET GUN

No. 760. Use a couple of pumps for indoor shooting or pump up to velocities of 550 fps in the great outdoors. Holds 180 BB's. Also shoots .177 Caliber Super Pellets as single-shot bolt action. 35" length. Adjustable Rear Sight. Hand rubbed walnut stained. Checkered stock and forearm.

GEBO'S PRICE

**\$29<sup>95</sup>**



## litronix CHECKMATE 1101

Add, subtract, multiplies and divides. Floating decimal, clear entry key, clear key, automatic overflow indicator, 8-digit solid-state light display, one year unconditional guarantee.

SPECIAL!

**\$10<sup>95</sup>**



GEBO'S



3-AA ALL DISTRICT

# Olton, Littlefield Dominate Honor Team

TURNER NAMED TO FOUR POSITIONS

Victory champion Olton and runner-up Littlefield completely dominated the District 3-AA All District as they combined for 20 of the 28 spots. Olton's do-everything player, Bill Turner, was named to the elite team in four positions, including three as a running back, safety, kicker and punter.

Other Wildcats to make the team include Larry McDonald as an offensive lineman, Jimmy Durham as a corner back, Rick Hopping at a defensive lineman position and Randy Hall at a defensive line position.

All the Wildcat players to make the team are seniors.

Olton players on the star-studded team include Jimmy Parker at quarterback, Glen Johnson at running back and linebacker, Michael Franks and

Mark Stroebel at ends with Stroebel also listed as a safety, J. D. Caudle and Kent Pittillo at offensive linemen positions, Kevin Workman at a corner back position and Ray Rodriguez at a defensive linemen position.

All of Olton's selections are also seniors.

Friona and Dimmitt had three members each make the team while Morton had two.

The entire District 3-AA All District Teams is listed on page 10 of this issue.



STEVE CRUZ  
OFFENSE AND DEFENSE



JIMMY DURHAM  
DEFENSE



RANDY HALL  
DEFENSE



RICK HOPPING  
DEFENSE



LARRY McDONALD  
OFFENSE



BILL TURNER  
FOUR POSITIONS

GUSTS TO 60 MPH

## Wind Damage Reported Over Area

Winds played havoc Saturday, reports coming in of street signs and Christmas decorations blown down. Cotton trailers by the score were damaged. Winds fanned a small burr on the Olton Farmers Co-op Gin out and for a time fire threatened and an unknown number of trailers were overturned. To the east of this area numerous counties were put under a

and units were still on the scene at midnight. The burrs were still on fire and a possible hazard through Monday.

At Sudan Saturday morning winds caused so much damage that there were false reports that a tornado had hit the area. Tin from barns was stripped off, trees were toppled over, and trailers were overturned. To the east of this area numerous counties were put under a

tornado watch. At Amherst, tin was torn off the drive-in theatre and scattered over Highway 37.

An unknown amount of damage was done to the unharvested cotton. Blowing tumble weeds and high winds blew cotton out of the burrs, and cotton not blown out was filled with dirt which will lower the grade considerably.

### SAVE AT GEBO'S

**litronix 1101P**

This is Litronix' back-to-basics calculator. The 1101P performs all basic arithmetic functions plus chain and mixed calculations with complete ease. A powerful percent key makes quick work of add-on, discount, mark-up and yield calculations. Repetitive addition and subtraction calculations are equally simple. Three penlight size AA batteries, included with the 1101P, will provide up to eight hours of continuous use. Alkaline batteries will increase operation up to sixteen hours. An AC adapter is available as an optional purchase. This unit eliminates the batteries and operates on normal house current. The slim design of the Litronix 1101P makes it a perfect pocket calculator.

GEBO'S PRICE..... **\$19<sup>95</sup>**

**litronix 2230**

The unforgettable Memory. In addition to all basic functions, it has a full accumulating memory (including exchange key), percent and square root keys and offers automatic constant for all four arithmetic functions. It also has three big exclusives: long lasting on/off keys; an automatic system that remembers to turn itself off if you forget; and a flashing "Error" signal when improper sequential entries are attempted. Three inexpensive penlight size AA batteries are all you need for up to 8 hours of continuous operation. Alkaline batteries will produce up to 16 hours of continuous use. An optional AC adapter is available for use from normal house current.

GEBO'S PRICE..... **\$29<sup>95</sup>**

**litronix 2260**

The unique slide rule calculator. The Litronix 2260 has automatic exponential notation override from eight digit floating decimal display; a memory system — performs natural parenthetical entry of complete algebraic expressions, accumulating memory and store-recall memory; advanced square/square root system — does square and square root of sums, sums of squares and square roots without re-entering intermediate results; constant Pr (1); plus the exclusive Litronix on/off keys, automatic shut-off system and "Error" signal. Three penlight size AA batteries provide up to 8 hours of use and alkaline batteries will give you 16 hours. An optional AC adapter, which bypasses the batteries, is available for use from normal house current. The rechargeable 2260 is also available. This model, as with all Litronix rechargeable calculators, will provide up to 8 hours of normal use. The unique slide rule, another Litronix pocket calculator, is ideal for home, office, classroom or travel use.

GEBO'S PRICE..... **\$39<sup>95</sup>**

# NEWS

15 CENTS

NOVEMBER 4, 1975

10 PAGES

## Contestants in Toyland Pageant Unfurls Friday Night

The Toyland pageant will be tomorrow, Friday, at the High School Auditorium in mission will be \$1.50 for tickets for children under 12. It is being sponsored by We, with Pat Marcum serving as emcee.

Contestants in the 5 and 6 year-old age groups are: Staci Birkelbach, 5, daughter of Mr. and Mrs. Randy Birkelbach; Letitia Trimmer, 5, daughter of Mr. and Mrs. Eddie Trimmer; Angie Stueart, 5, daughter of Mr. and Mrs. Danny Stueart; Mitzi McLelland, 6, daughter of Mr. and Mrs. Arthur McLelland; Tammy Reed, 6, daughter of Mr. and Mrs. T. J. Reed; Melissa Kelton, 6, daughter of Mr. and Mrs. Dale Kelton; Shannon Crews, 6, daughter of Mr. and Mrs. Mike Crews; and Carrie Lynn Sawyer, 5, daughter of Mr. and Mrs. Chet Sawyer.

In the 7 and 8 year-old category contestants entered are: Leslie Ann Warren, 7, daughter of Mr. and Mrs. Wade Warren; Dawnna Denton, 7, daughter of Mr. and Mrs. Jerry Don Denton; Michelle Jones, 7, daughter of Mr. and Mrs. David Jones; Teresa Baily, 8, daughter of Mr. and Mrs. Kenneth Bailey; and Shawnda Masten, 8, daughter of Mr. and Mrs. Danny Masten.

Presenting the 1975-76 winners will be last year's winners, Tiffany Page Simpson, daughter of Mr. and Mrs. Arlen Simpson and Deanna Jones, daughter of Mr. and Mrs. David Jones. Contestants are rehearsing tonight at 7 o'clock.

See photos of the contestants in this issue of the paper.

## Capture the Winner

The Wildcats remained undefeated last night as they defeated Muleshoe Mules, 62-53, and Richard Rogers led the team as they each tossed 11 for Littlefield. Rudy Ayala with 5 and 2.

The girls will be in the Kress Tourney scheduled to play Hale at 2:30 p.m. in opening round of the 'Cats fifth night Dee Blevins stated this win was a great one and 8 or 9 players do an excellent job of our success attributed to the fact of good bench strength in an outstanding game and in rebounding and Perrin both came off the bench to do good jobs for us."

The varsity girls defeated Muleshoe, 54-48.

Monica Phillips scored 33 big points in the victory and had scoring help from Pennie Sexton with 12 points, Rhonda Hollingshead with 5 and Carol Sexton tossed in 4.

The girls will be in the Kress Tourney this weekend also and they are



MONICA PHILLIPS gets high off the floor to battle for the rebound in Littlefield's victory over Muleshoe Tuesday night. Twitty scored 14 points in the contest as did Richard Rogers to lead the 'Cats to the 62-53 win. It was Littlefield's fifth win of the season against no losses. Other Wildcats in double figures Tuesday include David Davis with 11 and Narva Simington with 10. Varsity teams will be in action this weekend in the Kress Tournament. (Staff Photo)

**December 10**

The newly elected Community ASC members will hold their Annual Meeting in the Lamb County ASCS room nine o'clock in the morning on Dec. 10, 1975.

A public meeting to elect or reelect members to the County ASCS will be held at 7:30 p.m.

and grade 25 to 37 percent. Mark reductions were assigned to 18 percent of the samples classed.

Staples 29, 30 and 31 were predominate lengths. Staple 29 was 25 percent, staple 30 - 35 percent and staple 31 was 19 percent.

Mike readings 3.5 through 4.9 amounted to 13 percent of the total. Mike group 3.3 through 3.4 accounted for 11 percent, 3.0 through 3.2 range 34 percent, mike 2.7 through 2.9 was 27 per-

cent. The Council will also continue the discussion on the drilling permit requested by Texaco. No decision was reached Monday night at the public hearing.

discuss use of IMCA Management Orientation Program for City Internal Training, discuss City Engineer drawing plans and specifications for water line extension to Littlefield Plaza and discuss the water and sewer extension policy.



Elegant Velvet!



# HEDGEROW COLLECTION

FOR THE COZY, COMFORTABLE COUNTRY-LOOK

The motif is natural, the colors neutral and the pattern subtle. This newest addition brings the rustic qualities of the countryside into your kitchen and dining room.



...always in good taste...

- 7 PIECE SET
- 1 - 5 Quart Dutch Oven with lid
  - 1 - 1 1/2 Liter Saucepan with lid
  - 1 - 3 Quart Saucepan with lid
  - 1 - 10 inch Skillet

GEBO'S PRICE

# \$38<sup>95</sup>



Hedgerow



Four Seasons Design

# Four Seasons COLLECTION

AS LOVELY AS A CENTERPIECE FOR YOUR TABLE

Now cookware goes boutique. With bouquets of flowers. In rich reds, bold golds, the tropical greens and luscious blues. They're the prettiest patterns under the year 'round sun.

## GREAT GIFT IDEAS FROM GEBO'S

# NEW! POLLENEX DIAL MASSAGE

There is no other showerhead that performs like it, anywhere. Just turn the dial to select the water action you like, a different and distinct spray, in unique actions, including gentle to vigorous. The new pulsating massage action works like thousands of fingers stroking, kneading, tired, aching muscles. Installs in minutes for a lifetime of pleasure.

- ADJUST TO THE FEELING YOU WANT:
- PULSATOR MASSAGE
  - COURSE SPRAY
  - FINE SPRAY
  - WATERFALL MASSAGE

HAND HELD MODEL  
Reg. \$20.95 SPECIAL ... **\$18<sup>88</sup>**

WALL MOUNT MODEL  
Reg. \$34.95 SPECIAL ... **\$29<sup>95</sup>**



GEBO'S STOCKING STUFFER

# BIC LIGHTER

# 77¢

# GEBO'S



# CB RADIOS

## PAGE JOHNSON GEMTRONICS



23 CHANNEL CB AM TRANSCEIVER  
MODEL CB 123A **\$155<sup>93</sup>**

50839

Made of solid Lucan technology! Based in point

## litronix series 3000 family of digital timepieces

Bright, long-lasting solid-state light emitting diode display of hour and minute functions with a pulsating indicator for seconds readings • Quartz Crystal accuracy, stable to within  $\pm 3$  seconds per month • LED Red scratch resistant crystal •

Shock Resistant • Anti-Magnetic • Operates on two button cell batteries that will provide service for approximately one full year with normal usage (average of 20 readings per day) • One Year Warranty against defects in materials and workmanship.



GEBOS'S PRICE

**\$39<sup>95</sup>**  
TO **\$79<sup>95</sup>**

MODEL: 2001  
CASE: Stainless Steel Case  
BAND: Metal Mesh

MODEL: 1100  
CASE: Stainless Steel Case  
BAND: Metal Mesh

MODEL: 3300  
CASE: Stainless Steel Case  
BAND: Metal Mesh

MODEL: 1201  
CASE: Stainless Steel Case  
BAND: Metal Mesh

MODEL: 1401  
CASE: Stainless Steel Case  
BAND: Metal Mesh

**FOR DAD**

**JOHNSON MESSENGER 123A & 123B**

The most popular CB radio in America... now with a voice tailored audio and acoustically isolated speaker system for clearer messages, less noise and a 100% solid-state chassis also features built-in electronic speech compression, mechanical selectivity filter, automatic noise limiting and gain controls, its illuminated metering gives relative transmitter output and received signal strength readings. Messenger 123A... the 23-channel mobile with Johnson performance and reliability... at a popular price!

**\$152<sup>95</sup>**

**CHECK GEBOS'S CB RADIO DEPARTMENT FOR COMPLETE RADIO ACCESSORIES**

Total performance and feature-packed value were designed into the CB 123A. PACE requires to achieve new highs in practical values with an output of 15 watts. With full five watts of RF power to draw from, the PACE 123A offers an performance ability with speech compression to achieve an unobscured transmitted audio quality, super sensitive dual channel receiver offers high efficiency noise eliminator that reduces spurious and other related noise. The PACE 123A is a leader in the world of CB communications with public address, speech compression, "on the air" transmit and "receive" indicators, lights and all solid state performance.

See 2x601 Wx7D Wt 5 lbs.

**PACE MODEL CB 123A**

**\$152<sup>95</sup>**



**GEMTRONICS GTX-23 23 Channel CB/AM MOBILE TRANSCEIVER**

with RF Meter, ANL, PA, Delta Tune (positive/negative)

**\$155<sup>95</sup>**

**GEBOS'S**



Elegant Velvet!

Generously proportioned sofa

Models of solid  
Lounge mahogany



# CANDY for Christmas

DERAN'S

**CHOCOLATE PEANUTS** 99¢  
No. 294, 12 oz. . . . . GEBO'S Price

**CHOCOLATE CLUSTERS** 99¢  
No. 293  
GEBO'S Price 1 LB. . . . .

**CHOCOLATE STARS** 99¢  
No. 292  
GEBO'S Price 12 OZ. . . . .

# CHRISTMAS



## PAPERCRAFT GIFT WRAP

5 Rolls Gift Wrap, 2 Foil, 3 Paper,  
45 square feet total. Reg. \$2.25

SALE PRICE **\$1.97**

ADD THE FINEST TOUCH TO  
YOUR HOLIDAY GIFT  
WRAPPING  
PAPERCRAFT

## RIBBON ASSORTMENT

EVERY COLOR IN  
THE RAINBOW!

SALE PRICE **79¢**

Wrapping paper supplies available  
in Plainview, Clovis, Hereford & J  
Amarillo only.

1975 at

# GEBO'S

**THE NEW GENERAL  
STORE OF THE  
SOUTHWEST**



PRICES GOOD DEC. 1st thru DEC. 13th  
OPEN ALL DAY SATURDAY thru CHRISTMAS

# GEBO'S



# LAMB COUNTY LEADER-NEWS

VOLUME 53 NUMBER 36 LITTLEFIELD, LAMB COUNTY, TEXAS, SUNDAY, AUG. 31, 1975 2 SECTIONS 18 PAGES

15 CENTS  
TAX INCLUDED

## Wildcat Football Fortune On Way Up

The Littlefield Wildcats are destined to move up the district ladder. Last year seasoned football prognosticators who bravely publish their predictions prophesied that Littlefield would end up fourth in this district. Littlefield finished fourth in the district.

This year the pigskin seers have picked Littlefield second in the district. "We certainly think we will be an improved football team this year," head football coach Jerry Blakely said in his usual understated way.

Blakely said a big reason the team will be improved this year over last is the great deal of experience returning in the skill positions of quarterback, running backs and linebackers.

Twelve lettermen returned who started one game or more last year, offensively, defensively, or both. The lineup will run a similar offense as last year, but Blakely anticipates better results.

Ronald Palmer returns offensively as quarterback. The 5'9", 160-pound senior captain is expected to be one of the better passers in the district, and is considered a very fine option quarterback.

Rick Hopping is a bruiser at 6'1", 215 pounds, and should be the best blocking fullback in the league.

Returning halfback Bill Turner made All-District as running back last year, racking up over 1,400 yards.

Larry McDonald, 5'11", 175-pounder and Brad Banner, 5'9", 170 pounds are both seniors returning as offensive guards.

Dean Walden is a six-footer weighing 185 pounds, and Randy Hall is 5'11" and weighs 180. Both of these seniors saw some action last year as offensive guards.

Starting center Jack Speck, 5'9", 170-pound, should be one of the better centers in the league.

Jimmy Durham, a 6 foot, 170-pound senior, has been moved from offensive tackle to tight end. "He had tremendous two-a days," Blakely said, "and he could possibly be the best tight end since I've been in Littlefield. He blocks well, catches very well and has adequate speed and size."

Offensive people returning include Danny Martinez, coming up from the junior varsity. At the present time he has the edge for split end position. He is small at 5'7", 135 pounds, but he has exceptional hands and a habit of making great catches.

Right now plans call for Reginald Payton and Steve Cruz at tailback positions. Payton is 6', 175 pounds, and Cruz is 5'9" and 170. Both are seniors, and both started defensively last year as linebackers. Robert Hall, 5'8", 145-pound junior, and Dean Walden will provide depth in these positions.

Blake Wood is a 5'8", 150-pound junior fullback who should get a great deal of action at that post. While not big, Blakely said Wood is quick and determined.

Defensively, the Cats have changed their basic defense from the split 6 to the Oklahoma 50 defense. The reason for the change is not dissatisfaction with the defense used the last four years.

"Our defense has been good and that's one reason we've had success these four years," Blakely said. "However, we did not feel that it best suited our personnel this year."

"We feel like Hopping has to play in the middle of the defensive front. That's the reason for the change. He'll be lined up as a noseguard and should be the best around here." Tony Cowen, 5'9", 150-pound junior should do a good job at defensive noseguard. He is exceptionally quick and has the desired knack of pursuing the football.

With experienced linebackers Cruz and Payton, defensive tacklers, McDonald, Speck and Hall, Blakely is looking for the defensive ends and defensive secondary to be the most improved area.

"The defensive end position has been a pleasant surprise thus far," Blakely added. Banner is the only veteran, but he's looked well in practice thus far. And we have three newcomers who'll see a great deal of action there this year. I'm very pleased with the performance of David Jones, 6'5", 180-pound sophomore, Layne McKinnon, 5'11", 165-pound junior, and Jasper Colbert, 5'11", 165-pound senior."

Blakely said inexperience in the secondary is a major concern right now, but that he does not doubt the ability of Turner, Durham and Palmer, of three proven hands to do their job.

Blakely said he is pleased to say there are three or four inexperienced football players who look like they will do a good job in the secondary, also. These are Lonnie Twitty, 5'6", 140-pound senior; Rudy Ayala, 5'8", 145-pound junior, Jay Lee a 135-pound junior and Blake Wood.

"It looks like more depth back there than we originally thought," Blakely added. "Add to that three sophomores with the varsity football team this year. While young and inexperienced at this time, they are very determined and their effort has been good in practice. As a result, Jones, Greg Moreland, 6', 150-pound, at offensive tight end, and Ronnie Milligan, 5'10", 155-pound offensive center, will figure heavily in our plans this year."

"Our players and coaches are excited about this year."

"Our players and coaches are excited about this year's football team and we think we have an opportunity to have a good team and we're anxious to get started," Blakely said.

"We play a lot of tough teams, but right now our only concern is our first game."

## Commissioners Court Contracts With City for Ambulance, Fire Protection Services



The Lamb County Commissioners Court was hit for money from all sides in their end-of-month session Friday.

City manager Jim Blagg and two city councilmen, Paul Carmickle and Chester Harvey, met with the Court Friday morning requesting the county pay \$200 per rural fire call, rather than the \$50 paid this year, and renewal of the county's contract for ambulance service which is estimated to cost about \$40,000 this year.

The Court agreed to pay \$100 per fire run outside the city limits, after some discussion pointing out that a paid fireman can't drive the truck on rural calls. On calls outside the city limits the fire department must wait for a volunteer fireman to come drive the truck.

The ambulance service contract was renewed as is, but commissioners pointed out that it looked like the county would have to budget in about \$40,000 for this expense.

Donald Carr and Buddy Logsdon appeared and asked for additional facilities at the new County Ag and Community Center. Among their proposals was a portable show ring, a wash rack, concrete sheep pens, and a four-foot concrete walkway through the steer barn. Total facilities asked for would cost an estimated \$23,000.

After lunch, Herschel Randall and Hubert Henry met with the Court on behalf of the proposed new Lamb County Memorial Library and asked that the Court pledge money toward the building of a new facility. Total cost of the structure is estimated at \$200,000 to \$250,000, and the board members pointed out that government grant would expire if the necessary amount of money and pledges aren't obtained by next summer.

Buddy Logsdon had requested a new pickup and met with the court again concerning competitive bids. Four sealed bids on a trade-in were not opened because Logsdon had not taken the pickup around to all the dealers in the county and bids were not submitted from all prospective dealers.

Frances Turner and Nora Hicks submitted a tentative library budget for the coming year reflecting additional expenditures for shelving, cassette tapes and player, postage and telephone.

Due to the many requests and additional expenditures by department heads who submitted budgets for 1976, the Court postponed any budgeting and did not act on the agricultural facilities nor pledge an amount to the library building until more detailed work is done on the budget next month.

which serves as a laundry center, and has a party room and storm cellar.

(Staff Photo)

WORK IS PROGRESSING on the Sunset Slope Mobile Home Park, located on Sunset Avenue, and owned by Jerry Smith. In the background is the new office building,

## County Court Cases Set For Trial, Jurors Called

Forty-six criminal cases were set for trial in county court this week.

County Judge Bill Angel has set arguments and trials for Tuesday. Among the cases set are 17 charges of drunk law violations, two charges of check by check, five charges of driving while intoxicated, six charges of liquor violation, one charge of carrying a gun, and three traffic offenses applied to county court.

A list of 50 jurors were drawn and notified.

Cases and charges slated for this session of county court include Jesse O. ... speeding; Gary Franks ... speeding; Julian Segura, Jim ... Mrs. Lucy Segura, Jerry Dawson, ... Garcia, Carolyn Martin, Edwin ... Elroy Ramirez, Mrs. M. L. ... Mrs. Roland Williamson, Andy ... Mrs. Paul Beisel, Gilberto ... Dale Berry, and Robert ... all charged with check law violation.

Charged with driving while intoxicated were Ronald Lynn Stewart, ... Glasscock (settled), Lamar ... Pickrell (settled), Mikel Kelly ... and Mickey Joe Mills.

Liquor law violation charges were being argued against Kenneth L. Ferguson, ... Hinojosa (settled), Cleo ... Willie Ray Bell, Eula McCarty, ... John Hernandez (settled).

Elroy Johnson was charged with ... Robert J. Hogue was charged ... carrying a pistol, and Robert ... Lavana Franklin were ... charged with theft by check. A traffic ... violation appealed to county court was ... failure to yield right of way by ... C. Keene.

Jurors called for this session of county court include Mrs. Roy P. Jones, Littlefield; Lucille Campbell, Earth; ... Dickerson, Littlefield; Mrs. Joe ... Dorsey, Sudan; Maurice Kinnie, ... Mayne Hopper, Littlefield; ... L. F. Glenn, Olton; Mrs. Pedro ... Littlefield; Margie Mandrell, ... E. Jones, Springlake; H. W. ... Littlefield; Wayne Rutherford,

Earth; Mettie Shugart, Littlefield; Mrs. R. R. Morrow, Amherst; C. R. Roberts, Amherst; Mrs. W. B. McDonald, Earth; Mrs. H. F. White, Spade; Neil E. West, Littlefield; Mrs. V. R. Stagner, Amherst; Earl C. Rodgers, Littlefield; Don Joyner, Fieldton; Patricia E. Street, Littlefield; Serbando Casares, Olton; Carle E. Hoppe, Littlefield. Helen Holley, Amherst; Elias Cantu, Earth; N. B. Oliver, Anton; Christopher Serratt, Sudan; Mrs. Robert Ohair, Rt. 4 Muleshoe; Roy H. McAfee, Olton; Mrs.

Sheila B. Park, Earth; Mrs. A. W. Ormand, Sudan; Jane Owens, Littlefield; Mrs. T. L. Dunlap, Littlefield; Mrs. Leon Smith, Littlefield; James B. Stites Jr., Littlefield.

Mrs. L. Z. Anglin, Earth; Sue Holt, Earth; Roye Aikman, Olton; James D. Black, Rt. 1 Anton; Melvin West, Littlefield; Myrlene Bridwell, Littlefield; Kathy Williams, Littlefield; B. L. Skinner, Springlake; Olivia Perea, Littlefield; Robbie Parish, Earth; and Emma J. Patterson, Amherst.



NEIL WOOD, seated, Dixey Ratliff (standing center) and Ronnie Hardin, right, received individual cash awards and an office incentive award certificate in a ceremony in the Littlefield Farmers Home Administration office Wednesday afternoon. State FmHA Director, Jay Lynn Futch, left, made the presentation for outstanding personnel performance in carrying out the high volume of loans through the Emergency Farm Operation Loans program. (Staff Photo)

## Labor Day Dollar Day, No Holiday

Monday, Sept. 1, which is Labor Day, will be business as usual in Littlefield, when merchants stage their monthly Dollar Day bargain sales.

Financial institutions will be closed, along with governmental office, but the majority of businesses will be open.

School classes will be in session, and students will not get a holiday. Look inside this issue for Dollar Day specials as presented by Littlefield merchants.

## 5 Jailed, Thefts Reported To County

The last part of the week five were jailed. Three Littlefield men were filed on by Emmitt Rose. Charged with the theft of a welder and electric air compressor from Rose Thursday night were Willie Ray King and Leonard Chambers. Both Littlefield men's bonds were set at \$2,500. Holbert Ray Coston was charged with receiving and concealing the items. His bond was set at \$5,000.

Roy Lee Wilson of Sudan was charged with violation of probation, and a Littlefield man was charged with driving while license suspended and fined \$50 plus court cost.

Two other thefts were reported to county officers. Keith Boone southeast of Springlake reported the theft of a tool box and tools valued at \$100. Bill Roper of Littlefield reported a chain hoist valued at \$75 taken from his farm northeast of Littlefield.

## Littlefield FmHA Receives Certificate

The Littlefield based office of the Farmers Home Administration received an incentive awards certificate, and Neil Wood, FmHA county supervisor, Ronnie R. Hardin, FmHA assistant county supervisor, and Dixey Ratliff, county office assistant, received cash awards Wednesday from Jay Lynn Futch, FmHA state director.

Presentations were made in the Littlefield office Wednesday afternoon. Also present for the occasion was Don Perry, FmHA district director from

Amarillo.

The Littlefield office made 385 active loans this year totaling \$7.5 million, with the majority of the loans going to farmers in this area based on the 1974 emergency drought program. This is a record number of loans and money.

The certificate and cash awards were for outstanding performance by all personnel for overcoming exceptional and unusual difficulties in handling a high volume of Emergency Farm Operation Loans for the 1975 crop year.



1975-76 WILDCAT VARSITY FOOTBALL TEAM



## Duran-Trejo Wedding Vows Realized

Mary Duran and Nato Trejo, both of Littlefield, exchanged double-ring wedding vows Saturday afternoon in the Sacred Heart Catholic Church. Officiating was Rev. Joe James, pastor, as the couple stood at the altar decorated with multicolored cut flowers and an apricot background. Candles marked the family pews.

Parents of the couple are Mr. and Mrs. Conrado Duran of Littlefield and Mr. and Mrs. Ramiro Trejo of Littlefield. Conrado Duran presented his daughter for marriage. She wore a formal-length wedding

gown of silk with lace overlay, featuring a square neckline edged in flowered lace, long lace sleeves, and a full skirt with five tiers of lace which fell into a medium-length train. Her shoulder-length veil of illusion fell from a crown of lace. She carried a spray of white gardenias, carnations and roses. Traditional musical selections of "We've Only Just Begun," "Bridal March," "Twelfth of Never" and "Song of Joy" were presented.

Connie Duran of Littlefield was her sister's maid of honor. Bridesmaids were Mary Duran of Denver, Colo., sister-in-law of

the bride, and Julia Rodriguez of Littlefield.

They wore Grecian style dresses of apricot crepe gently gathered over the bodices and falling from small belts at waists. Their gowns were sleeveless and fashioned with V necklines, and were complemented with long gloves.

Leroy Behnke of Littlefield was best man. Groomsmen were Sonny Duran of Denver, Colo., brother of the bride, and Jubencio Rodriguez of Littlefield.

For her daughter's wedding, Mrs. Duran wore a blue, pink and white knit street-length dress, fashioned with short sleeves and rounded neckline. Mrs. Trejo wore a green and tan polyester knit street-length dress fashioned with short sleeves and a V neckline.

Following the wedding, a reception was served in the Sacred Heart Parish Hall near

the church. Serving the three-tiered wedding cake, decorated with swans holding pillars, were Sonny Duran, sister-in-law of the bride, Mrs. Julia Rodriguez, and Connie Duran, the bride's sister. Also with the hospitality were relatives of the couple. They will reside in Littlefield where the groom is employed in the City of Littlefield in the water department.

The bride attended Littlefield High School and the groom is a 1973 graduate of LHS.



MRS. NATO TREJO

## Bi-Centennial Quarters And Half Dollars Now Available At The First National Bank

LITTLEFIELD, TEXAS

MEMBER FDIC

**CURITY**  
Cotton Balls  
for cosmetic use  
and baby care



REGULAR \$1.25

**59c**

## DOLLAR DAYS



**CURAD**  
BONUS BOX  
SALE

80 Assorted Transparent Bandages

**49c**

**SKIN CLEANSER**

MEDICATED



1 BAR

**79c**

**Colgate**

**TOOTHPASTE**

COLGATE

FAMILY SIZE

7 OZ

**69c**

**PEAK**

**TOOTHPASTE**

PEAK

FAMILY SIZE

7 OZ

**49c**

**Colgate**  
**Toothbrush**  
REGULAR

**19c**

**SKIN CLEANSER**

SPECIAL MEDICATED



2 OZ

**\$1.49**



**Wilkinson**  
**SWORD MASTER**  
XCN Chromium  
7 Blades

**59c**



**TOOTHPASTE**

GLEEM 11

5 OZ

**49c**



**Wilkinson**  
5 BONDED™ Blades

**69c**

**HAND CREAM**

BALM BARR

7 OZ

**\$1.39**



**PALMOLIVE**  
**RAPID-SHAVE**

11 OZ

- Rich Regular
- Cool Mint
- Fresh Lime

**59c**

**MOUTHWASH**

SCOPE

40 OZ



**\$1.49**

**RODEN REXALL DRUG**

STORE HOURS: 8 A.M. TO 7:00 P.M. MON. TO SAT. 9 A.M. TO 5:00 P.M. SUNDAY

WE RESERVE THE RIGHT TO LIMIT QUANTITIES

**VITAMINS**

THERGRAN

130 COUNT

**\$3.98**

**BATH OIL**

ALPHA KERI

8 OZ



**\$2.19**



# Alpha Lambda Zeta Starts New Year

Members of Alpha Lambda Zeta Chapter of Beta Sigma Phi met Sunday afternoon, Aug. 24, in the home of Brenda Denton to celebrate "Beginning Day".

"Beginning Day" is celebrated each year by the 250,000 members of Beta Sigma Phi throughout the world to begin the new year.

President Brenda Denton greeted each member and presented her with a program and theme charm of "Let Heritage Ring." She began the day by welcoming and thanking each girl for her participation in

the summer activities.

Darlene Maxfield led the opening ritual, and Janice Sebring, scrapbook chairman, presented Deanna Friday, past president, with her scrapbook.

On behalf of all the members, Charla Rountree and Brenda Denton presented Deanna with a decoupage group picture of the members and a shadow box containing a miniature gavel for her service as president.

Deanna in return, surprised the members with the announcement from International that our chapter has received a three-star rating.

Penny Kelton led the closing ritual concluding the program for the afternoon.

The serving table decorations consisted of a liberty bell centerpiece under an archway bearing the theme "Let Heritage Ring". Surrounding the bell were clusters of miniature yellow roses. Linda Charlton

and Deanna Friday served refreshments of cupcakes decorated with large yellow roses, springtime punch, assorted nuts and mints to: Cathy Hufstедler, Linda Jones, Brenda Denton, Ruan Richardson, Janice Sebring, Darlene Maxfield, Penny Kelton, and Charla Rountree.

## 'We, Women' Make Plans For Dinner Style Show

"We, The Women" met Wednesday, Aug. 27, in the Southwestern Public Service Reddy Room with vice president, Pat Marcum, presiding.

Marge Anzeline and Susan Wilemon reported on the success of the 8th Annual Art Show. They reported that the president of the Arts and Artists Club, Mrs. Robert McDonald, presented "We, The Women" a guest book containing the names and addresses of the local and area artists.

Style show chairperson, Mozelle Tapley, gave a detailed report of the final plans for the

Dinner Style Show to be held Tuesday, Sept. 9, in the new Lamb County Agricultural and Community Center.

Theme for this year is "Fall Into Fashions of '76," featuring cotton fashions of 1976 to the modern fashions of 1976.

The Dinner Style Show is a new thing for Littlefield and the first for "We, The Women." The meal will be catered by Vann's Catering of Lubbock and the tickets for the meal and show are \$3.50.

Tickets may be purchased from Carol Black, ticket chairperson, at Security State Bank.



ALPHA LAMBDA ZETA members are, top row, left to right, Ruan Richardson, Darlene Maxfield, Janice Sebring, Penny Kelton, Carol Haile, Janice Appleton and Linda Charlton. Seated, left to right, are Mary Giles, Deanna Friday, Charla Rountree, Cathy Hufstедler, Linda Jones and Brenda Denton. (Personal Photo)

## County Coin Club Sets Show

The Lamb County Coin Club met Tuesday night with 17 members present to finalize plans for their annual show Sunday, Nov. 2.

This year's show will be different from those of previous years, according to Dr. J. H. Oyer, publicity chairman.

The show will open at 9 a.m. and continue until 5 p.m. in the new Lamb County Agriculture and Community Center, located on South Hall Avenue (Highway 385), and will be a wildcat show.

In defining a wildcat show, or an "all hobby" show, Oyer states that the show will include (besides coins) all kinds of antiques, guns, jewelry, bottles or anything that people collect.

This year's door prize will be a \$5 gold piece, which will be drawn near the close of the show, from admission tickets.

Price of admission is 50 cents. Children under 12 years old will be admitted free if accompanied by paid admission.

## Scholarship Tests Scheduled

College scholarships from \$500 to \$5,000 are available to all high school seniors through the Betty Crocker Search for Leadership in Family Living, now underway in its 22nd year.

Invitations to enroll in the program have been mailed to high schools across the nation.

Enrollment deadline is Oct. 31, 1975.

LITTLEFIELD SCHOOL Cafeteria

DAY: Sloppy Joes, tomatoes, French fries, pudding and milk.

DAY: Steak and gravy, buttered carrots, light brownies and milk.

WEDNESDAY: Pinto beans, cornbread, peach milk, and orange juice.

THURSDAY: Barbecue tips, hot rolls, green beans, and milk.

FRIDAY: Burritos, salad, fruit cocktail, and milk.



IS CLEAN OUT OF THIS WORLD.

VITABATH® GELEE.

enjoyable bath or shower. Yours. With a cap of Vitabath gelée. Like having a spa in your home. Vitabath gelée deep-cleans (without drying effects of soap). Even in hard water.odorizes (dependably all day long). Helps you wind—relaxes and revitalizes. Softens your skin. Soothes and smooths it. Does all this so pleasantly, so fragrantly you'll wonder how you managed so long without it.

temper yourself with the Vitabath bath or powder. Famed abroad as batedas, it's a beautiful habit. Once you use it you'll never be satisfied with soap again.

Three fragrances: regular Vitabath, a lively, woody scent. Vitabath Pink, a refreshing, floral scent and zesty lemon.

Brittain Pharmacy  
Littlefield, Texas 79339

## Sudan Fireman Hold Barbeque

SUDAN—The Volunteer Fire Department had their annual barbeque and awards dinner Saturday, Aug. 23.

Some 75 persons, including firemen, and their families and special guests were served.

Special guests were Dorothy Jones, City of Sudan secretary; and Mr. and Mrs. Homer McLaurly, past deputy sheriff for Sudan.

Pete Phillips, president of the department gave recognition to special guests.

Orville Hill, fire chief, presented the fireman of the year award to Theron Hill for his outstanding service and to Pete Phillips for 15 years of service. Other firemen were recognized by Chief Hill for the number of years each had served with the department.

The department, at their regular meeting Aug. 25, elected officers for the 1976 year. They are Malcom Martin as president; Damon Provence, vice president; Bob Taylor, secretary and fire marshal; Orville Hill, fire chief; Pete Phillips, assistant fire chief; Bob Davison, second assistant chief; Theron Hill, third assistant chief; Phillip Gordon, reporter and Bob Carson, sergeant at arms.



MOZELLE TAPLEY, chairman of the style show being scheduled by 'We, The Women', presents complimentary tickets to Bob Jones and Mickey Brewer of American Cotton Growers' Textile Plant. The show and dinner are set Tuesday, Sept. 9. (Personal Photo)

## Boys Ranch Rodeo Gets Underway

Two performances of the 31st Annual Boys Ranch Rodeo are scheduled for 2:30 p.m. the Labor Day weekend, Sunday and Monday, with approximately 10,000 people expected to drive to Carl Farley's Boys Ranch for the event.

And added attraction will be barbecue beef plates and other refreshments sold by the boys.

The reserved box seat tickets are \$2.50 and general admission is \$1.50 for adults and 75 cents for children. Proceeds of the rodeo are used for the operation and expansion of the Ranch.

### Labor Day FOOD SAVINGS

CHUCK ROAST LB 89¢	FRESH GROUND BEEF LB 79¢	GRADE A SMALL EGGS DOZEN 3 FOR \$1
CAR MAYER FRANKS 1 LB PKG \$1.25	KIMBELL'S PEACH HALVES NO. 2 1/2 CAN 55¢	CRISCO 3 LB CAN \$1.69
KIMBELL'S BORK & BEANS NO. 2 1/2 CAN 45¢	KIMBELL'S ALL PURPOSE DETERGENT GIANT SIZE 89¢	CRACKER BARREL CRACKERS 1 LB BOX 45¢
CITY CROCKER CAKE MIX LOW, DEVIL FOOD, WHITE 65¢	COCA COLA 12 OZ CANS 6 PAK 99¢	DR PEPPER 12 OZ CANS 6 PAK 99¢

NEW STORE HOURS:  
MON THRU SAT 8 A.M. - 8 P.M. SUN, 8 A.M. - 1 P.M.  
QUALITY MEATS COST NO MORE AT

## MERLIN'S FOOD

Double Gunn Bros. Stamps, Tuesday & Wednesday  
9th & Levelland Highway

OPEN 7 DAYS A WEEK WE REDEEM FOOD STAMPS  
PRICES GOOD MON, THRU SUN.

# Financial Security Doesn't Just Happen...

## It Takes Planning!

See Us About One Of Our Individual Savings Plans Just Right For You.

### SECURITY STATE BANK

YOUR COMMUNITY EVERYTHINGBANK



# EDITORIAL

## 'Safety Proof' Your Youngsters

IT'S THAT TIME of year again when parents should attempt to "safety proof" their youngsters—many of whom are entering school for the first time.

Whether walking, riding in a bus or car, or bicycling to school, plans should be made to ensure the safety of every child, reminds the Texas Department of Health Resources.

Darting across streets without looking, crossing at mid-block from between parked cars, and doing bicycle tricks in traffic are just a few of the pitfalls to be avoided, advises the Health Resources Department.

PARENTS CAN caution their children about all careless practices, and they also can show them. If your child is starting to school—or going to a new school—it's a good idea to make the trip at least once with the child.

If he will be pedaling to and from school every day—often in inclement weather—you'll want to be doubly sure that your child is observing safety rules. If you're a motorist in the vicinity of schools, be especially wary, says the Health Resources Department.

WHAT ARE THE TROUBLE spots for bicyclists and motorists? Collisions between motor vehicles and bicycles occurs about as follows:

- \*Well over half at intersections.
- \*Seven out of ten during daylight hours.
- \*Most bicycle riders killed or injured in traffic accidents, were violating a traffic law at the time of the incident.
- \*Half of the motor vehicle-bicycle accidents involved a violation on the part of the motor vehicle operator.
- \*One out of five bicycles involved in accidents had some mechanical defect.

SOME OF THE MOST common traffic violations of bicyclists are (not in order of frequency):

- \*Failure to yield right-of-way. (In most cases, the bicyclists did not "see" the car; in some cases he intentionally

infringed on the motorist's right-of-way.)

- \*Riding in the center of the street.
- \*Speed too fast for conditions of traffic and road surface.
- \*Disregard of traffic control devices—signal lights and stop signs.
- \*Improper turning.

TO AVOID such situations as just described, here are some safety rules for bicyclists:

- \*A skillful bicycle rider always has his bike under control. He never drives too fast and he never rides too far. He always has both hands free to steer.
- \*The cyclist must develop skill in balancing and pedaling to avoid swerving into traffic, hitting a fixed object, running off the sidewalk or high way. Parents have the responsibility to be certain their child has the skill to cope with traffic before permitting him to ride on the street.
- \*Every bicycle driver should be familiar with the laws governing bicycling in his community, or the one in which he is riding. These rules are usually available through the school or local police.
- \*Cyclists must ride on the right side of the street with the flow of traffic; not on the left, facing traffic.
- \*Hand signals should be used by the bicyclists, and are now commonly accepted as a safe riding practice.
- \*Cyclists should avoid crowding between cars at stop signs, or between an automobile and the curb.
- \*Carrying more passengers than a bicycle is designed and equipped for is dangerous and illegal. Two on a bike also increases stopping distances. The polo or "banana" seat, standard equipment on the hi-rise bike, appears designed to carry two. Such is not the case!
- \*Never hold onto a moving vehicle nor in any way attach the bike to the vehicle.
- \*Always ride single file.
- \*Trick riding is always dangerous. Drivers of hi-risers are especially cautioned against making the bike rear up and riding on back wheels only, or jumping the bike over obstacles.

## Combine Adjustment Suggested For Sunflowers

"Seed losses due to improper combine adjustment can result in substantial financial losses to sunflower producers," says Buddy C. Logsdon, County Extension Agent.

To minimize these losses, combine operators need to equip their machines with special sunflower header attachments. In addition, operators should frequently check the performance of their machines and make adjustments as harvesting conditions change.

The agent says that studying the operator's manual is the first step toward efficient harvesting and should not be neglected for this new crop by even the most experienced operators. Most manuals list recommended machine settings and other tips for sunflower harvesting.

The agent points out that combine manufacturers generally recommend that the reel speed should be matched to ground speed. Cylinder speeds of 350-600 r.p.m. are suggested, with the lower speeds being best for dry conditions. Concave clearances range from 1/2 to 1-1/2 inches. It is suggested that an initial concave clearance of 3/4 inch be used, then adjusted as necessary.

The agent cautions that excessive cylinder speed and close concave settings break up the heads excessively causing overloaded sieves and difficulty in separation and dehulling of the seed.

Most manufacturers also suggest a chaffer setting of 1/2 to 5/8 inches and sieve opening of 1/2 inch.

The air adjustment must be watched carefully to prevent seed from being blown or carried over the sieves. In setting the air, Logsdon suggests starting with a slow fan speed and gradually increasing the speed until the desired results are obtained.

"Some producers have voiced concern about removing 'pops' or unfilled seed during the harvest operation. Removing pops has not been a big problem in other areas," states Logsdon. "A sufficient amount of air to remove chaff usually carries out the lighter unfilled seed."

"Be alert to refining adjustments to match the machine, moisture conditions and other crop conditions. To do a good job of harvesting," Logsdon urges, "combine operators need to frequently check their machines and make adjustments as necessary."

## Grain Sorghum Producers To Elect Board Members

Grain sorghum producers in the High Plains area will elect four members to the Texas Grain Sorghum Producers Board on Oct. 16.

Nominations will be accepted through Sept. 16 at TGSPB offices, 1708-A 15th St., Lubbock, Tx., 79401.

Directors whose terms will expire are Ralph Mabry of Petersburg, C. P. Smith of Hale Center, K. B. Parish of Springlake and Larry Witten of Olton. All are eligible for re-election.

Persons in the 29-county TGSPB area who produce grain sorghum and pay the board assessment are eligible to vote and to seek election. Any person wishing to be nominated for membership should make application by Sept. 16. The application must be signed by the nominee and 10 other eligible voters.

Eligible voters who do not receive ballots by Oct. 2 may obtain one from a county agent.

Counties in the Texas Grain Sorghum

Producers Board area besides Lamb County are Armstrong, Bailey, Briscoe, Carsons, Castro, Cochran, Crosby, Dallam, Dawson, Deaf Smith, Floyd, Gaines, Hale, Hansford, Hartley, Hockley, Hutchinson, Lubbock, Lynn, Moore, Oldham, Parmer, Potter, Randall, Sherman, Swisher, Terry and Yoakum.

**LAMB COUNTY LEADER-NEWS**

ESTABLISHED 20 YEARS

Lamb County Leader  
Circulation Office, 15, 19th

WIDE A. BISHOP	Editor
JOELLA LOVVORN	Business Manager
WILLIAM B. BAKER	Advertising Manager
ESTELLE WEAVER	Circulation
CHARLES BLANKS	Advertising
CHARLOTTE BELL	Advertising
TRINA MARTINEZ	Advertising

Second Class Postage Paid at Littlefield, Texas 79228

PUBLISHED semi-weekly except Thursdays and Sundays. Circulation Office on Texas 1517-A 15th St. Littlefield, Texas. Phone 342-2111. Second class postage paid at Littlefield, Texas. Postmaster: Please send address changes to LEADER-NEWS, P.O. Box 15, Littlefield, Texas 79228. Country rates: \$6.00 a year and \$1.00 for each of four issues.

### BACK TO SCHOOL



MOTHER'S BIG DAY!

## CLIPS & TIPS

By JOELLA LOVVORN

WELL, AREA FARMERS will be contributing soon to the newest ice cream flavor—"Sunflower Ice Cream". The new flavor was originated in Windber, Pa. by a dairy there which is noted to be "cashing in on the current health food craze". The new sunflower ice cream is a blend of sunflower kernels from North Dakota and Minnesota that are toasted and seasoned in sea salt. And who knows, they may be using Texas sunflowers pretty soon—or maybe a Texas dairy will produce it in Texas fashion.

The ice cream is currently being marketed in 11 cities in southwestern Pennsylvania and the producers have written the Shell Book of Firsts in London to have the new flavor recorded in its next edition.

The confection contains the whole seed kernel in a buttercream flavoring, with golden yellow and white swirls. The seeds are lightly salted and oiled just enough to keep the sunflower-seed taste. As Joe Greuble, who dreamed up the flavor, says, "It's for people and not the birds."

He says the current gardening trend and the emphasis on nutrition and health foods helped plant the seed for "our nuttiest flavor."

Down the road in Latrobe, Dr. David Strickler came up with a similar brainstorm 71 years ago. Bananas were cheap and plentiful so Dr. Strickler tried a new sundae on some students at St. Vincent's College.—the popular banana split. He had a special dish made to hold the two banana halves and the other goodies that went on top. The students spread the word when they returned home about the wonderful banana splits they ate at Tassell's Drug Store. Soon banana splits were selling in all parts of America and now in almost every country in the world.

Greuble hopes to match Dr. Strickler's feat with such slogans as, "Look What's Sprouting—Sunflower Ice Cream—Euell Love It."

MOST OF US USE canned foods without ever giving a thought to just how convenient they are. Those soups and sauces that took your grandmother hours of chopping and simmering are right there on the shelf, ready to heat and serve any time.

Any vegetable or fruit is ready to go straight from the can to your dinner table all year round.

But for the best use of these convenience foods, learn how to take care of your canned goods—before and after opening.

The Food and Drug Administration has a fact sheet just for canned food users called "Questions and Answers about Canned Foods." This valuable information is available free from Consumer Information, Department 44, Pueblo, Colo. 81009.

Among the questions answered are:

- \*Where should I store canned goods?—The best storage area for canned foods is in a moderately cool, dry place. You should avoid storing them near steam pipes, radiators, furnaces and kitchen ranges.
- \*How long will canned foods keep?—This is variable, but, generally speaking, if the can itself is normal in appearance the food inside should be wholesome. However, a regular turnover of once a year is recommended.
- \*Is it safe to leave unused portions of canned foods in the can after opening?—Yes. But it is important to place the can inside the refrigerator, just as you would any other cooked food. Acid foods may dissolve a little iron from the can if they stand a long time, but this will only affect taste, not quality.
- \*Does damage to the outside of the can mean the food is unsuitable for use?—Not necessarily. Rust or dents don't affect the contents of the can as long as the can doesn't leak. However, if the can is leaking, or if the ends are bulged, or if the contents have an abnormal odor or appearance, discard the can without tasting the food—it's probably spoiled.

Does damage to the outside of the can mean the food is unsuitable for use?—Not necessarily. Rust or dents don't affect the contents of the can as long as the can doesn't leak. However, if the can is leaking, or if the ends are bulged, or if the contents have an abnormal odor or appearance, discard the can without tasting the food—it's probably spoiled.

## OBITUARIES

**OLA EDNA ARNOLD**  
Funeral services for Ola Edna Arnold, 75, who died at 5:30 p.m. Thursday, Aug. 28, in Lubbock's Methodist Hospital following a short illness, were conducted Saturday morning in the First Christian Church of Hobbs, N.M.

Officiating was Rev. Errel Stepp, pastor.

Graveside services were conducted that afternoon in Littlefield Memorial Park with Hammons Funeral Home in charge of arrangements.

Mrs. Arnold had lived in Hobbs 22 years, and was a retired school teacher. She was born Aug. 20, 1900 in Wharton, and was a charter member of the First Christian Church of Hobbs.

Surviving are her husband, Dave Arnold of Hobbs; a brother, Emmett Baisden of Turkey; and three sisters-in-law, Mrs. J. T. Baisden of Lubbock, Mrs. O. L. Baisden of Littlefield and Mrs. Emmett Baisden of Turkey.

deducted Saturday morning, Aug. 9, in the Duenkel Memorial Chapel in Pampa. Officiating were Bill Dunaway, minister of the Fritch Church of Christ, and Don Stone, minister of the Clarendon Church of Christ.

Burial was in the Mobeetie Cemetery with Duenkel Funeral Home in charge of arrangements.

Mrs. Elliott was born Sept. 21, 1896 in Fayetteville, Ark. She had lived in Las Vegas, N.M. from 1949 to 1973, when she moved to Irving.

She was the mother of Mrs. Claude (Zelma) Emmons, former Amherst resident who now reside in Irving.

**LYNN EARL SLATE**  
Lynn Earl Slate, 86, of Sudan died at 9 a.m. Wednesday, Aug. 27, in Amherst Manor Nursing Home in Amherst.

## HOMINY GRITS

By CORNBALL B...

UNCERTAINTY IS beginning to fill the air again. Congress is about to reconvene. While it's said they got a fearful earful while home on vacation, we're confident that they'll be uneasy for long.

It's maddening to hear how the bill covering their pay increase was practically sneaked through the mill, tied onto a bill concerning postal employee safety. A bunch of the fellows didn't even know the bill was coming up 'til a couple of days ahead of time. People at home were unaware of the same, until it was already passed!

TO ADD INSULT to injury, it had the blessing of the Administration. I'm afraid we'll mark that one of the wall in laundry pencil!—After all it would seem that near \$125 per day for 365 days of the year is a little out of line. That especially when they're milking the local yokel that thinks he's doing well to gross that much per week!

Multiply that by the number of congressmen we have, and you come up with a pretty fair sized paycheck. Which, of course, wouldn't gripe us so much if they could only show some constructive action.

BUT, THEN, AS WEVE before, I'm afraid we'll not expect too much, during the except some pretty dirty between parties.—Alack and

THERE'S ONE INVESTMENT made during the last 15 years really growing. Not every I've entered into has that into peanuts. Life insurance have become ineffectual in Automobiles lose their work alarming pace. Savings Bonds becomes insignificant.

BUT THE INVESTMENT that is growing by leaps and that is the old house in which it wasn't so gigantic when we it. "Maybe large enough to family of four, conveniently, it has begun to swell. The first expansion was in '72.

However, this week the noticable, it's almost frightful Spring of '73 was the time my one son entered the Marine week son number two is loading college. He's the last of the

## LETTERS TO THE EDITOR

(EDITOR'S NOTE: This is a letter that was sent to parents and guardians of students in Littlefield Public Schools concerning the lunch program.)

Dear Parent or Guardian:

The Littlefield School serves nutritious meals every school day. Students in kindergarten through the fourth grade may buy lunches for 50 cents. Students in grades five through 12 may buy lunches for 60 cents.

To apply for free meals for your children, at anytime during the year, complete the attached application and bring it to Nina Talburt in Room 12 in the Primary building. The school will let you know whether or not your children are eligible at the time the parent or guardian brings the application to Mrs. Talburt.

If you do not agree with the school's decision, you have a right to a fair hearing. This can be done by calling or writing Mrs. Joyce Oliver, Room 13, Primary school, Telephone No. 385-4600.

In certain cases foster children are also eligible for these benefits. If you have such children living with you and wish to apply for such meals for them, please notify us or indicate it on the application that you bring to school.

All children are treated the same regardless of ability to pay. In the operation of child feeding program, the child will not be discriminated against because of his race, sex, color or national origin.

If we can be of any further assistance or if your income changes during the year, please contact us.

Sincerely yours,  
s/Jack York  
Jack York  
Superintendent

Family Size	Annual Family Income
1	\$0-3,230
2	0-4,240
3	0-5,250
4	0-6,260
5	0-7,190

Each additional family member \$750.  
The parents or guardian must the application to Room 12.  
Wade A. Warren, Publisher  
The Lamb County Leader-News  
Box 72  
Littlefield, Texas 79239

Dear Mr. Warren:  
We have been receiving inquiries about the rodeo boys putting on over the Labor Day and if you can find space for the closed, it will be greatly appreciated.

The boys are quite excited by the rodeo and although school has started another year, they really do not their minds on schoolwork. They been getting ready for this rodeo about three months and it will take time for them to settle down.

Thank you for the past help given them with the publicity and hope you and your family or members your staff can attend one of the performances.

Sincerely,  
Cal Farley's Boys Ranch  
s/Louie Hendricks  
Louie Hendricks

Wade Warren  
Lamb County Leader-News  
Littlefield, Texas

Dear Mr. Warren:  
"We, The Women" would like to press appreciation to you and your for the publicity you gave us at Annual Art Show.

We would also like to thank Vandenberg of KZZN Radio Station Cal Harvey for all the help he gave. Last, but not least, we want to big thank you to all the area artists and individual artists who made show a success.

Sincerely yours,  
s/Marge Anzeline  
Chairman Art Show

Solis had lived in Nazareth nine years. He was a former resident.

Solis is survived by five sons, Solis of Anton, Arthur Solis of Calif., Manuel Solis of Littlefield, Richard Solis and Patricia Solis of Laredo; one daughter, Mrs. Ybarra of Anton; his mother, Francis Reyes of Navasota; brothers; two sisters; 14 grandsons and one great-grandchild.

Cancer Memorial gift fund may be sent to:

GLORIA JACKSON  
Security State Bank  
Littlefield, Texas 79239

American Cancer Society



# Webster-Hudson Gowns Repeated in Friona

Donna Jean Webster and Joe Hudson, both of Friona, exchanged wedding rings on Saturday, Aug. 9 in Friona's Calvary Baptist church. The ceremony was performed by Rev. Ron Trusler. The bride's parents are Mr. and Mrs. Ronnie Webster of Friona. The groom's parents are Mr. and Mrs. Wayne A. Jones of Friona. The church was decorated with a large candelabra with blue carnations and gladiolus. The bride wore a floor length white satin dress with a lace collar, long sleeves and a white skirt. The bodice was decorated with spring flowers. The couple traveled to Roswell, N.M. for their wedding trip. The bride will be a senior at Friona High School and is employed at Carrol's Printing in Friona. The bridegroom attended Friona schools and is engaged in farming. Out-of-town guests attending the ceremony and reception were Mr. and Mrs. Marvin Webster and Mr. and Mrs. Red Montgomery, grandparents of the bride, all of Littlefield, Mrs. Clyde Spann and children of Plainview and Mr. and Mrs. Carl Mayfield of Dimmitt, grandparents of the groom.



MR. AND MRS. JACKIE HUDSON

### 1000 Persons View 'TEXAS'

The echoes of "Texas" rolled through the canyon of the Palo Duro on Saturday night in this summer's performance of "Texas", Green's musical drama of the Texas Panhandle. The production is celebrating its 10th anniversary with more than 92,000 people seen "Texas", making the production the largest audience in the history of the show. Twenty-nine percent of the audience came more than 500 miles to see it. Twenty-eight percent came from out-of-state. Thirty-seven came from within a hundred mile radius of the canyon. The rest traveled more than 100 miles and less than 500. Auditions will begin in January for the eleventh season. For information, write Box 268, Canyon, Tex. 79015.

# Top o' the List Food Specials

WE RESERVE THE RIGHT TO LIMIT QUANTITIES

<b>OXYDOL JOY FLOUR BREAD SPINACH COCA COLA DR PEPPER BATHROOM TISSUE TOMATO JUICE FRUIT DRINK PAPER TOWELS</b>	GIANT SIZE 22 OZ SIZE GLADIOLA 5 LB BAG TENDER CRUST, FAMILY SIZE SHURFINE, NO. 303 CAN	\$1.19 69¢ 69¢ 2/79¢ 4/\$1	MARKET CHOICE LB CHOICE LB USDA, LB EXTRA LEAN LB CHOICE, LB	\$1.29 79¢ \$1.19 59¢ 79¢
<b>ARM ROAST CHUCK ROAST FAMILY STEAK BEEF RIBS GROUND MEAT</b>				\$1.38 \$1.38 79¢ 59¢ 39¢ 59¢

<b>ASPARAGUS EGGS</b>	SHURFINE, NO. 300 CAN GRADE A MEDIUM, DOZEN	49¢ 57¢	<b>RANCH STYLE BEANS SYRUP</b>	300 SIZE SHURFINE OR BLACKBURN, QUART	3/89¢ 89¢
-----------------------	--	------------	--------------------------------	--	--------------

**CANNED COKE** 12 OZ  
or  
**DR PEPPER** **6/99¢**

<b>SAUERKRAUT PINESOL COFFEE DOG FOOD SNOWDRIFT COOKING OIL CHARCOAL JELLO PINTO BEANS VANILLA WAFERS</b>	SHURFINE, NO. 303 CAN 28 OZ SHURFINE, 1 LB CAN ROXEY, TALL CANS 3 LB CAN SHORTENING JEWEL, 38 OZ ENERGY, 10 LB BAG 3 OZ, ASSORTED RANCH STYLE KEEBLER, 12 OZ PKG	3/89¢ \$1.19 99¢ 7/\$1 \$1.69 89¢ 89¢ 2/39¢ 3/89¢ 59¢
---	---	--

<b>COOL WHIP FISH STICKS ORANGE JUICE CREAM PIES POT PIES</b>	BIRDSEYE, 9 OZ SHURFINE, 8 OZ SHURFINE, 6 OZ MORTON, ASSORTED MORTON	59¢ 39¢ 4/\$1 59¢ 3/89¢	<b>FROZEN FOODS</b>
---	--	-------------------------------------	---------------------

<b>BUTTERMILK WHIPPING CREAM COTTAGE CHEESE SOUR CREAM</b>	BORDEN, 1/2 GALLON BORDEN, 8 OZ BORDEN, 12 OZ BORDEN, 8 OZ	65¢ 39¢ 43¢ 39¢	<b>DAIRY CASE</b>
--	---	--------------------------	-------------------

<b>POTATOES TOMATOES GREEN ONIONS ROASTING EARS GRAPES</b>	NO. 1 RUSSET, 10 LB BAG CELLO PACK FARM FRESH GOLDEN BANTAM THOMPSON SEEDLESS, LB	79¢ 29¢ 2/29¢ 3/29¢ 39¢	<b>FRESH FRUITS &amp; VEGETABLES</b>
--	---	-------------------------------------	--------------------------------------

CONVENIENT LOCATIONS 332 E. DELANO AND 601 E. 10th

AFFILIATED

## Pay-n-Save

QUALITY AND SERVICE

WE GIVE GUNN BROS STAMPS  
DOUBLE STAMPS TUESDAY & WEDNESDAY WITH \$2.50 OR MORE PURCHASE (EXCLUDING CIGARETTES)  
WE RESERVE THE RIGHT TO LIMIT QUANTITIES  
WE REDEEM AND GIVE STAMPS ON FOOD STAMPS  
WE SELL TRAVELERS EXPRESS MONEY ORDERS, PAYROLL CHECKS CASHED

## LIGHT & RIGHT

for rugged work

Red Wing Cures 5 oblock Feet

- Cushion crepe sole and heel
- Rugged full-grain leather upper

**Anthony's**



## New Church Organized

A new church has been organized in Littlefield, according to its pastor, Claude Woods.

The Church of Littlefield is meeting temporarily at 116 W. 10th street.

Bible study is conducted every Sunday at 9:45 a.m., morning worship begins at 11 a.m., Bible

Fellowship begins at 6 p.m. and evening worship starts at 7 p.m.

According to the pastor, "The Church of Littlefield is a New Testament Church, and we believe that no man or group of men have authority over the Bible. We do not cut it in bits and pieces, but we accept it as a whole!"

"We believe that God is alive and well today, and is just as powerful, as gracious, as merciful as ever; that He still wants to work among His

people, and desires to save the souls of men.

"We invite you to come and worship the Lord, In Spirit and In Truth with us."

## WHITHARRAL

MR. AND MRS. Jimmy Hisaw at Broken Bow Lake in Oklahoma, Lake Quachita and returned home from vacationing Lake Gruson near Hot Springs,

Ark. They visited in Nashville, Ark. with Mr. and Mrs. Bee Street former Littlefield residents.

MR. AND MRS. Lloyd

Strickland are parents of a weighing 7 lbs., 14 1/2 oz. was born Tuesday, Aug. 26, at St. Mary's Hospital in Littlefield. DANNY GRANT has a patient in Littlefield.



### Lamb Bowling Lanes

Has been purchased by  
GLENN DAVIS

The Bowling Lanes will be open September 2nd and leagues will begin organizing Sept. 8.

Glenn would like to extend a cordial invitation to all to come out and bowl.



OLDEST MAN present for the Pioneer Reunion Tuesday was Joe D. Nixon of Littlefield, 88. Mrs. Emily Peterman presented him two gold-embossed cups as a prize. (Staff Photo)



RECEIVING THE PRIZE for the oldest woman present at the Pioneer Reunion Tuesday was Mrs. Floyd Waldon of Littlefield, 88. Two others present were older, Mrs. Farquhar and Mrs. Emfinger, but both had received prizes for the honor in the past. (Staff Photo)



A. E. LICHTER of Littlefield received the prize for the longest being in the county the longest. He says he came to Littlefield years ago, and was presented two gold-embossed cups at the annual Pioneer Reunion Tuesday. (Staff Photo)



JESS DOW of New Haven, Conn., and who traveled miles to attend the annual Pioneer Reunion Tuesday received the prize for traveling the farthest. (Staff Photo)



LITTLEFIELD  
508 Hall Avenue

OPEN LABOR DAY

Prices Good Thru Saturday

Bank Americard and Master Charge As Good As Cash At **GEBO'S**



**DURALON**  
SUPER FLOAT IMPLEMENT TIRES

SIZE	PLY RATING	CATALOG	PRICE
9.50-14	6	M4YY8S	\$21.62
GEBO'S SPECIAL			
9.50-15	8	M4YY6R	\$26.98
GEBO'S SPECIAL			



225 AMP  
**LINCOLN WELDER**

Easy to operate—Dial type current selects welding currents from 40 to 225 amps in 12 steps. No cranking or loose plugs to fool with. Economical to own. The average cost of using this machine is 3 or 5 cents per hour. Price includes accessory kit.

Reg. \$123.95  
GEBO'S SPECIAL

**\$109.95**



**SANBORN AIR COMPRESSORS**

34A5014 14 gal. tank, 1/2 H.P. electric motor, 3.4 CFM ball bearing compressor pump.

GEBO'S SPECIAL ..... **\$99.95**

44A7515 15 gal. tank, 3/4 H.P. motor, 4.4 CFM Dial-O-Matic control.

GEBO'S SPECIAL ..... **\$124.95**

64A10015 15 gal. tank, 1 H.P. motor, 6.4 CFM twin cylinder V compressor

GEBO'S SPECIAL ..... **\$179.95**

84A10022 22 gal. tank, 1 H.P. heavy duty motor, 8.46 CFM twin cylinder pump

GEBO'S SPECIAL ..... **\$259.95**

104A15022 22 gal. tank, 10.4 CFM pump, twin compressor, 1 1/2 H.P. motor

GEBO'S SPECIAL ..... **\$299.95**



**DUREX ANTI-FREEZE**

GEBO'S PRICE .....

**\$3.77**

ASK ABOUT OUR QUANTITY PRICES

HI-LIFT  
**3 1/2 TON FARM JACK**

7,000 Lb. Capacity. Weighs only 31 lbs. 48" continuous lift. Jack up trucks, tractors, wagons, combines, pickups, buildings. Pulls posts, pipes, roots, small stumps, stretches woven or barbed wire fence, splices wire.

GEBO'S SPECIAL **\$24.95**



**The Qwik-Test Portable Moisture Tester**

**Measures:**  
Sorghum, Beans, Corn, Soybeans, Sunflower, Wheat

The Qwik-Test Portable Moisture Tester is an accurate, shock resistant, moisture management tool for harvesting, drying, animal ration mixing, silo-filling and long term storage.

- Lightweight
- Built-in scale
- Automatic temperature control
- Solid-state indicator
- Field portable
- Battery operated

GEBO'S SPECIAL **\$89.95**



**GEBO'S**

SHOP AT THE NEW GENERAL STORE OF THE SOUTHWEST!

## Homemakers Serve Supper

Littlefield Young Homemakers of Texas met Thursday for a salad supper in the Flame Room of the Pioneer Natural Gas building.

They discussed plans for the Area I Convention Sept. 8th, with several members making plans to attend.

Members made plans to set up an exhibit depicting the "Spirit of '76" theme. Those planning to attend and stay for the banquet are asked to contact Alice Potts, president, and advise of plans to attend.

Current cards are in and members are urged to pick up their cards from Bobby Magruder. A sale will be conducted in the near future.

Secret pals were revealed with gag gifts, and pals guessed who their gifts came from.

New officers will be elected and installed in September.

The salad supper was served to guests, Renae Coley, Mary Harbin, Vestella Williams, Mary Conley and to members, Bobby, Alice, Shirley Savage, Kathy Graves, Linda Harbin, Linda Elms, Janey Raney,

Janice McElroy, Bern Johnson and Ellen M... The next meeting will be 11 at 7 p.m. in the Flame Room. All area women are invited to attend.



**HAMMONS FUNERAL HOME**

### SEALED BIDS

930 Acres - Irrigated - W.W. Branscum Estate  
Located 17 Mi N of Sudan  
12 Mi E & 5 N of Muleshoe  
6 Mi W & 5 N of Earth

### Legal Description:

A. All of Sec 25 (except the SE 1/4) in Block 2 Halsell Subdivision in Castro & Lamb Co. 610 Acres

B. NW 1/4 Sec 26 Block 2 Halsell Subdivision Castro Co. 160 Acres

C. NW 1/4 Sec 7 Warren Subdivision league 583 Parmer Co. 160 Acres

Sealed bids will be accepted by Barry Lewis, 336, Muleshoe, Texas 79347 now through Sept. 1975.

Please indicate by A, B, or C which tract you are bidding on and mark envelope "Land Bid."

Bids to be opened in Barry Lewis' office at 10:00 A.M. September 24, 1975.

TERMS: Cash within 90 days

POSSESSION: January 1, 1976

Executors reserve the right to reject any or all bids.

T.L. Branscum  
806-965-2385  
or  
Arvel Branscum  
505-356-5883  
Executors

For more information call:



# FOOTBALL CONTEST

Enter Our Contest Each Week  
Nothing To Buy - Just Pick Winners

Win Cash Prizes  
Each Week

FIRST PLACE PRIZE

**\$10.**

SECOND PLACE PRIZE

**\$3**

THIRD PLACE PRIZE

**\$2**

**GRAND PRIZE**

2 TICKETS TO THE  
**Cotton Bowl**

NEW YEAR'S GAME  
Plus \$25.00 Expense Money



It's so easy...

Anyone can enter!

Read the rules...

Start Winning

**RULES**

**OF THE CONTEST:**

All you have to do to be eligible for the weekly cash prizes is to complete the form below and place (or mail) it in the designated box at the Leader-News office. It is the contestants responsibility to see that the form has been placed in the entry box and the Leader-News assumes no responsibility for blanks lost, or delayed in the mails.

One game is listed in each advertisement. Pick the winner and insert the name of that team in the OFFICIAL ENTRY BLANK below. Then in the "Tie Breaker" section, put the scores you believe each of the teams will make. Weekly judging will be based on the total number guessed correctly. In case of a tie, the tie-breaker will be used to determine the top winners. Decision of the Leader-News scoring judges will be final.

To be eligible for the 2 free tickets to the New Year's Game at the COTTON BOWL, the total number of correct guesses will be totaled through the season.

LIMIT—One entry per contestant per week.

BE SURE to complete the forms by PRINTING plainly your name and complete address and turning in the entry blank only. Contest winners will be announced in each Thursday's issue of the Leader-News.

ALL TIED GAMES ARE CONSIDERED WRONG UNLESS CALLED AS A TIE.

ZENITH  
TVs AND STEREOs

**GOODYEAR SERVICE STORE**  
A DIVISION OF THE GOODYEAR TIRE & RUBBER CO.  
304 W. 4TH  
Game No. 1 LITTLEFIELD, TEXAS 79339  
Morton at Plains  
DALE MAULDIN  
Store Mgr.  
Phone 385-5162

**Win Cash Prizes**

**Each Week**

FIRST PLACE PRIZE

**\$10.**

**Ernest Mills Cotton Co.**  
RARE COINS & COIN SUPPLIES  
"Always A Fair Price"  
Game No. 2  
Carlsbad at Lamesa  
1517 E. 9th 806 385-5178

**Shook Tire Co.**  
Game No. 3  
Sundown at Sudan  
1028 East 9th Phone 385-4405

**LITTLEFIELD SEED & DELINTING**  
"Home Of Fine Cotton Seeds"  
Game No. 4  
Hart at Anton  
In The Old Oil Mill Location Phone 385-3588

**ORIGINAL TASTY TACO**  
Game No. 5  
S-Earth at Amherst  
WE SPECIALIZE IN MEXICAN AND AMERICAN FOOD  
621 HALL AVE. PHONE 385-3764

**Littlefield Farmers Coop Gins & Elevators**  
Cooper at Littlefield  
Game No. 6  
"OWNED BY THOSE WE SERVE"

**ARMES EQUIPMENT CO.**  
Your John Deere Dealer  
Olton at Tulia  
Game No. 7  
East Loop 84 Phone 385-4121

**CONOCO JIM JONES**  
AGENT  
Crosbyton at Floydada  
Game No. 8  
AMHERST: Joe Miller, Bob Clayton, HART CAMP, V.L. Foster  
BULA: Dale Middlebrooks, PEP, Pop Gro. & Service

**Armes Chevrolet Co.**  
Denver City at Seminole  
Game No. 9  
New & Used Cars, Trucks, Pickups  
610 East 4th Phone 385-4437

**Pratt's Jewelry & TROPHIES**  
CUSTOM MADE PLAQUES AND TROPHIES OUR SPECIALTY  
5th AND XIT DRIVE  
Levelland at Brownfield  
Game No. 10

**OFFICIAL ENTRY BLANK**

amb County Leader-News Football Contest

Deadline 5:30 Friday

Game No. \_\_\_\_\_ Winner \_\_\_\_\_

\_\_\_\_\_

\_\_\_\_\_

\_\_\_\_\_

\_\_\_\_\_

\_\_\_\_\_

\_\_\_\_\_

\_\_\_\_\_

\_\_\_\_\_

\_\_\_\_\_

\_\_\_\_\_

\_\_\_\_\_

\_\_\_\_\_

\_\_\_\_\_

\_\_\_\_\_

**TIE BREAKER**

Littlefield vs. Cooper

Brownfield vs. Levelland

\_\_\_\_\_ vs. \_\_\_\_\_

\_\_\_\_\_ vs. \_\_\_\_\_

\_\_\_\_\_ vs. \_\_\_\_\_

\_\_\_\_\_ vs. \_\_\_\_\_

**Football Contest**





TO PLACE YOUR LOW COST WANT AD. 3 8 5 - 4 4 8 1

Rates on CLASSIFIED ADVERTISING are 10 cents per word 1st insertion (\$1.50 minimum charge) and 6 cents per word 2nd insertion (\$1.00 minimum charge). Blind box ads are \$1.00 additional. DISPLAY CLASSIFIED RATES: \$1.40 per column inch first insertion and additional insertions, \$1.15 per column inch.

**Real Estate**  
30 acres dry land stock farm. Close to pavement. No improvements. Contact L. Peyton Reese. TF-R  
Real Estate: Small lot on 19th St. Cres. Park addition. Call Merlin Yarbrough, 385-4755. TF-Y  
FOR SALE by owner 320 acres of land near Pep, New Mexico, 25 south and 2 miles east of Portales, New Mexico. Call AC 505-356-4784 or 505-356-5210. 9-11-P

**House for Sale**  
Brick veneer at 700 Cres. Dr., facing park; 3 bedroom, 3 baths, 2 fireplaces, living room, large carpeted office, 2 car garage with shop, covered screened-in patio, fenced backyard, built in stove, dishwasher and garbage disposal, with Nutone service center, central refrigerated air and heat, carpeted, with built-ins and large closets; immediate possession. Call Bob or Mary Rogers at 385-3895 for additional information.

**Bus Service**  
UPHOLSTERY work done. Reasonable prices, home, office, auto, cushions and pillows. Call anytime, 385-4934. TF-F  
WILL BUILD re-enforced concrete cellars. Redbuilt houses. H.G. Ferguson, 385-5508. 11-30-F  
RENT CONVALESCENT equipment at Brittain Pharmacy. Wheel chairs, crutches, hospital beds, other items. Complete line convalescent needs. TF-B

**Misc For Sale**  
Miscellaneous Shop has a nice selection of new and used furniture and appliances, antique furniture, glassware, and lots of miscellaneous items. We buy, sell or trade. Come see us. 385-3714. TF-Y  
GRAIN-FED beef for your freezer. 85 cents per lb. 385-3821 or 385-5904 after 6. TF-B  
SERVICE STATION equipment for sale. 319 W. 3rd. 385-3682. TF-P

**Misc.**  
NOTICE: Senior citizens mini bus, Littlefield area, every Fri. Call 385-5425. TF-S  
TUMBLING, TRAMPOLINE offered in gymnastic classes. Afternoon classes scheduled for boys and girls in various grade levels. Children three years and older accepted. Two free lessons for those enrolling this month. For further information phone 385-5548 or 385-5288. TF-N

**SECTION** for sale. 250 acres, 17 miles north of Hereford, eight wells, tail water, all cultivated, 280 acres grain, 200 acres wheat, 160 acres sugar beets; section includes two brick two bedroom homes, carpeted, and in excellent condition, for more information, call Echols Realty, INC., Mary Morgan, (505) 762-9222. 8-31-E

**Lost & Found**  
LOST black Baldy Steer, 900 lb. If found notify Daryl Roberts, 227-4531, Sudan. Reward. 8-31-R  
**Motorcycles**  
GRIMES KAWASAKI. New and used motorcycles. Parts and accessories. Repair done on all motorcycles. Levelland Hwy. 385-3049. TF-G

**SEWER stopped up?** Let us unclog your sewer line with our Roto Rooter Service. Harrell Building Supply, Anton. 997-3621. TF-H  
TREWAX rug shampooer for \$2. per day. Harrell Building Supply, Anton. TF-H  
MATTRESSES complete renovating. New mattresses & box springs, any size. Call Mrs. Claude Steffey, 385-3386, agent for A & B Mattress Co., Lubbock, Tex. TF-S

RABBITS, does, bucks and cages. Call after 4 p.m. Sudan 227-6461. 8-31-P  
6 lots with well and electric pump. Storage house 12 x 24. Call 385-4687. TF-C  
USED trombone for sale. 385-4181. TF-D  
FOR SALE: Conn Constellation Cornet. 385-4938.  
BEANS and okra for sale. B. E. Turner, 385 By-Pass, across from John Deere House. T.F.

**Help Wanted**  
RESPONSIBLE person wanted to own and operate candy and confection vending route. Littlefield and surrounding area. Pleasant business. High profit items. Can start part time. Age or experience not important. Requires car and \$1395 to \$4795 cash investment. For details write and include your phone number: Department BVV, 3938 Meadowbrook Rd., Minneapolis, MN 55426  
ONE POSITION open at Lamb Co. Farm Bureau for insurance agent to service established accounts. Will train. See Ed Jennings, Lamb Co. Farm Bureau, 708 W. Delano, 385-4489. TF-J  
LVNs, cook. Apply in person Knight's Rest Home. TF-K

**Autos For Sale**  
1973 Vega Hatchback. Low mileage, extra clean. 385-5465. 8-31-K  
1971 Chevrolet Malibu, new tires. Call 933-2190. 9-4-A  
CLEANEST USED CARS in town. Marcum-Olds Cadillac, 8th and Hiway 385, Littlefield. 385-5171. TF-M  
GOOD clean 1965 Mustang. Extra good motor, 4 speed stick, radio and heater. See at 701 E. 15th. 385-4155. TF-W  
1967 Ford Fairlane, \$400. Call 385-4259. See at 1130 W. 9th after 5. TF-H  
1974 Plymouth Duster, blue with white vinyl top. Power, air, new Michelin radials. 385-4675 or 385-3366. TF-L  
1960 model Dodge Van. Ideal for a camper. Very good condition. Call 385-3921 or 385-5343 after 5 p.m. TF-C  
1972 Ford Pinto, 2,000 cc, automatic air, radio, \$1550. 385-3241, J.D. Ratliff.  
1971 Chevrolet pickup, 6 cylinder, 3 speed, 16-inch 6 ply tires. Excellent condition. 385-5867 or Sudan 227-5311, ask for Mike. TF-T  
'69 FORD Fairlane, automatic and air conditioning. \$750. 385-5973 after 6 p.m. TF-S

**SELL AND INSTALL** Aluminum windows and do painting. L. M. Synatzske, 997-4911.  
SUJU's Canine Grooming open Tuesday-Friday 9 a.m. to 6 p.m. Call 385-4234, 385-3247, 385-5871 for appointments.  
Campbell's Plumbing Co. Heating Air Conditioning Sheet Metal Work  
Complete stock of repair parts for all major lines of plumbing, heating, air conditioning products. Service on all major lines heating and air-conditioning equipment. Sales Service Installation. Bus. phone 385-5020 1022 E. 9th  
Industrial BEARING & BELTS Forney Welders & Supplies  
\*Farm Equip. G & C AUTO SUPPLY  
700 E. 14th  
385-4431  
Lee's Spanish Imports  
New Location  
402 Phelps  
Next door to Hazel's Beauty Shop  
LITTLEFIELD ROOFING ROOFING  
All types built-up asphalt roofs. Composition shingles. All work guaranteed. Call Ron Foshee, 385-5680, Littlefield, Texas.  
MARTIN ROOFING  
Roofing Specialists Roofing of all kinds Asphalts of All Kinds Asphalt Built-up Roofs All Work Guaranteed Littlefield 1115 W. 9th 385-3507  
Misc For Sale  
LADY JO Pea & Bean sheller guaranteed, extra parts available at no extra cost. \$14.32 includes tax and postage, 4607 29th, Lubbock, 799-3968. 8-31-L

**Greyhounds:** One 3-year old female, two 5-month males. 299-4631. 9-4-C  
OLDS Ambassador Cornet. Used 3 months. 385-3365. TF-W  
KENMORE gas cook stove for sale. Like new. \$100. 385-4867. TF-T  
REGISTERED poodle puppies for sale. Call 385-4611. TF-F  
BALED alfalfa hay. Phone 385-3636 or 299-4763. TF-N  
CARPET SPECIALS  
Commercials & tweeds \$5.75 up  
Kitchen Patterns \$8.00 up  
Regular Hi Lows \$5.95 up  
Short Shags \$7.00 up  
Multicolor sculpture shags \$8.75 up  
Astro grass \$6.50 up  
All 100% nylon installed on 1/2 inch foam pad.  
Samples & Free Estimates  
Call Jake or Bill Duncan 106 E. 14th St. Ph. 385-4953  
YOU take 'em. Used appliances! 2-40" gas ranges-Maytag gas, \$25. Universal gas-\$25. 1-Frigidaire Skinni Mini washer and dryer-green-\$275. 1-Frigidaire portable dish washer, \$50. Cox Furniture and Appliance, 1804 Hall, Littlefield.

**Color Contest Winners Named**  
SUDAN—First place winner of the Sudan Pay 'N Save coloring contest was Tammy Gore, according to store manager El Ray Rasco. Her coloring has now been forwarded to Amarillo to be judged along with over 300 other Affiliated Store first place winners. Tammy is the daughter of Mr. and Mrs. James Gore. Second and third place winners were Brad Byerley, son of Mr. and Mrs. El Ray Rasco, and Shelly Gore, the daughter of Mr. and Mrs. James Gore. Judges for the contest were Winifred Dykes and Jimmie Lou Davison.  
Changing Times  
At the time of the Revolutionary War, the average U.S. farmer used most of the same tools and followed many of the same practices that were in use during Biblical times.

**Personal**  
SHAKLEE Natural Food supplements, skin care. Basic-H cleaners. Satisfaction guaranteed. Free delivery. Ask about our better health kit. Phone 385-4746. TF-P  
I will not be responsible for any debts other than my own. Frank L. Dunn.  
LECITHIN! Kelp! B6! Cider Vinegar! Now all four in one capsule. Ask for VB6+ or VB6+ double strength. Roden Drug, 431 Phelps, 385-4250. 9-11-R  
LOSE WEIGHT safely and fast with X-11 diet plan, \$3.00. Reduce excess fluids with X-Pel, \$3.00. Brittain Pharmacy, 430 Phelps, 385-5114. 9-4-P  
Beauty By Mary Kay Call: Freddie Duke 385-5064 1318 W. 14th  
Real Estate  
CORNER LOT 12 and 1/2 of 11, 17th St. across from First Christian Church. Call 246-3250, Amherst, TF-D  
24x104' Brick and Tile building, formerly Robert's Studio.  
3 bedroom, 2 bath, 2 car garage. Extra large home with storm cellar.  
Drive-in located in Anton, Texas. This business will make a good return on investment.  
2 bedroom, 1 car garage on West Second. \$5,000. Robert Richards Real Estate 385-3293  
loop 84, brick, 3 bedroom, 3 bath, walk-in closets, basement, one acre, fireplace. 385-4204 385-4919.

**Mobile Homes**  
SACRIFICE!! \$560 down. Payments \$97.39, 2 bedroom, 52' x 14'. Furnished. Free delivery. 765-8277, 1419 N. University, Lubbock. 8-31-F  
HOUSE with 2 lots, Has pecan and fruit trees. In Baling, Tex. \$2500. Will take good used pick-up with trade-in. 385-4790. 8-31-M  
CRESCENT Park addition. Brick, 3 bedroom, 2 bath, living room, den kitchen dining combination, recreation with fireplace, utility room, covered patio, 2 car garage, storage room, big fenced back yard, central heat and air, over 2,200 sq. ft. living area. Priced to sell in low 30's. Shown by appointment. Call 385-3515. TF-H  
400 E. 14th St. 3 bedrooms, 2 baths, large living room, beautiful paneled den, lots of built-ins and closet space. Large enclosed patio with built-in stove, refrigerator and heating, ref. air-cond. unit, central heat, fenced back yard. Circular drive, rock garden, yard light, F.H.A. approved. Shown by appointment. Priced \$42,500. Call Mr. or Mrs. G.T. Sides, 385-3505. TF-S

**Bus Service**  
BISHOP PEST CONTROL  
Trees, Homes, Yards. 385-5492 or 997-5011  
Concrete Work  
Now is the time  
Call 385-6144  
Rosales Concrete  
Littlefield Office 410 LFD Drive Ph. 385-5149

**Bus Service**  
BISHOP PEST CONTROL  
Trees, Homes, Yards. 385-5492 or 997-5011  
Concrete Work  
Now is the time  
Call 385-6144  
Rosales Concrete  
Littlefield Office 410 LFD Drive Ph. 385-5149

**Color Contest Winners Named**  
SUDAN—First place winner of the Sudan Pay 'N Save coloring contest was Tammy Gore, according to store manager El Ray Rasco. Her coloring has now been forwarded to Amarillo to be judged along with over 300 other Affiliated Store first place winners. Tammy is the daughter of Mr. and Mrs. James Gore. Second and third place winners were Brad Byerley, son of Mr. and Mrs. El Ray Rasco, and Shelly Gore, the daughter of Mr. and Mrs. James Gore. Judges for the contest were Winifred Dykes and Jimmie Lou Davison.  
Changing Times  
At the time of the Revolutionary War, the average U.S. farmer used most of the same tools and followed many of the same practices that were in use during Biblical times.

Ch. 11 KCBD	Ch. 13 KLBK	Ch. 28 KMCC
6:30 * News Weather Sports 6:45 * Sacred Heart 7:00 * Jerry Falwell 8:00 * Day of Discovery 8:30 * James Robinson 9:00 * Rex Humbard 10:00 * Oral Roberts 10:30 * Kathryn Kuhlman 11:00 * Living Your Religion 11:30 * A Better Life 12:00 * Garner Ted Armstrong 12:30 * Meet The Press 1:30 * "Munster Go Home" 4:45 * Changing Times 5:00 * Hogan's Heroes 5:30 * NBC News 6:00 * Evening Report 6:30 * Walt Disney 7:30 * "Columbo" 9:00 * Weekend 10:00 * "Men's Favorite Sport" 12:30 * News Weather Sports	7:00 * This Is The Life 7:30 * Around The World In 80 Days 8:00 * U.S. of Archie 8:30 * Bailey's Comets 9:00 * Bullwinkle 9:30 * A Place To Talk 10:00 * Underdog 10:30 * Face The Nation 11:00 * Kaleidoscope 11:30 * Inquiry 12:00 * TBA 12:30 * Dallas/Houston U.S. Open Tennis 4:30 * Animal World 5:00 * Eric Sevareid 6:00 * Channel 13 News 6:30 * Harbotten Transfer 7:30 * Kojak 8:30 * 60 Minutes 9:30 * Jerry Telethon 10:00 * Channel 13 News 10:30 * CBS Sunday News 10:45 * Jerry Telethon	8:00 * Encounter 8:30 * Exciting Life 9:00 * Popeye & Pals 9:30 * Korg: 70,000 B.C. 10:00 * Gooder & Ghost Chasers 10:30 * Christopher Cleopatra 10:45 * First Baptist Church 11:45 * Film Feature 12:00 * Let The Bible Speak 12:30 * Issues & Answers 1:00 * Friends of Man 1:30 * Car & Truck 2:00 * "Cry of the Wild" 4:00 * U.S. Men's Amateur Golf 5:30 * Jimmy Swaggart Show 6:00 * Portrait of a Champion-Roger DuCoster 6:30 * Six Million Dollar Man 7:30 * "You Can't Win 'em All" 9:30 * "Five Pannies"
Ch. 11 KCBD	Ch. 13 KLBK	Ch. 28 KMCC
6:30 * All American Futurity 7:00 * Joe Garagiola 7:15 * Major League Baseball 8:00 * Weekend Wrap-Up 10:30 * Tonight Show 12:00 * Tomorrow 1:00 * News Weather Sports	6:30 * To Tell The Truth 7:00 * Gunsmoke 8:00 * Maudie 8:30 * Rhoda 9:00 * Medical Center 10:00 * Channel 13 News 10:30 * "V.C. of the Dolls" 12:30 * Channel 13 News	7:00 * The Rookies 8:00 * NFL Pre-Season Football Game 10:45 * KMCC News 28 11:15 * Wide World of Mystery
Ch. 11 KCBD	Ch. 13 KLBK	Ch. 28 KMCC
6:30 * Sanford & Son 7:00 * "The Invisible Man" 8:30 * Police Story 10:00 * Joe Forrester 10:30 * Weekend Wrap-Up 10:30 * Tonight Show 12:00 * Tomorrow 1:00 * News Weather Sports	6:30 * To Tell The Truth 7:00 * Good Times 7:30 * M*A*S*H 8:00 * Hawaii 5-0 9:00 * Beacon Hill 10:00 * Channel 13 News 10:30 * "Your Money Or Your Life" 12:30 * Channel 13 News	7:00 * "Mobile Two" 8:00 * "Satan's Triangle" 10:00 * KMCC News 28 10:30 * Wide World of Mystery
Ch. 11 KCBD	Ch. 13 KLBK	Ch. 28 KMCC
6:30 * Wild Kingdom 7:00 * Rich Little Special 8:00 * Sundberg's Lincoln-"The Unwilling Warrior" 9:00 * Oral Roberts in Alaska 10:00 * Weekend Wrap-Up 10:30 * Tonight Show 12:00 * Tomorrow 1:00 * News Weather Sports	6:30 * To Tell The Truth 7:00 * Tony Orlando & Dawn 8:00 * Cannon 9:00 * American Parade 10:00 * Channel 13 News 10:30 * "Gorgyones" 12:30 * Channel 13 News	7:00 * That's My Mama 7:30 * Jim Stafford Show 8:30 * "Starky & Hurch" 10:00 * KMCC News 28 10:30 * Wide World-Special
Ch. 11 KCBD	Ch. 13 KLBK	Ch. 28 KMCC
6:30 * Hollywood Squares 7:00 * The Montefiores 7:30 * Foy 8:00 * Medical Story 10:00 * Weekend Wrap-Up 10:30 * Tonight Show 12:00 * Tomorrow 1:00 * News Weather Sports	6:30 * To Tell The Truth 7:00 * The Dynamo Saturday Preview 7:30 * The Waltons 8:30 * Thursday Night Movie 10:00 * Channel 13 News 10:30 * "The Undeafed" 12:30 * Channel 13 News	7:00 * Evel Knievel-Portrait of a Daredevil 8:00 * Streets of San Francisco 9:00 * Harry O 10:00 * KMCC News 28 10:30 * Wide World-Special
Ch. 11 KCBD	Ch. 13 KLBK	Ch. 28 KMCC
6:30 * Hollywood Squares 7:00 * The Montefiores 7:30 * Foy 8:00 * Medical Story 10:00 * Weekend Wrap-Up 10:30 * Tonight Show 12:00 * Tomorrow 1:00 * News Weather Sports	6:30 * To Tell The Truth 7:00 * The Dynamo Saturday Preview 7:30 * The Waltons 8:30 * Thursday Night Movie 10:00 * Channel 13 News 10:30 * "The Undeafed" 12:30 * Channel 13 News	7:00 * Evel Knievel-Portrait of a Daredevil 8:00 * Streets of San Francisco 9:00 * Harry O 10:00 * KMCC News 28 10:30 * Wide World-Special

# Quasar

12" diagonal BLACK & PORTABLE TV

• Personal portable with crisp, clean picture!  
• 70-channel UHF "Click" Tuner  
• Custom-Matic Pre-Set VHF Tuner  
• Built-in recessed handle  
• Walnut grain finish plastic cabinet.

"GLARE GUARD" FILTER  
Snap-on shield, included with set, helps reduce annoying glare and outdoor reflections, adds to your TV enjoyment. Snaps on and off quickly.

**\$10995**

Model BP3070MW

## PAT'S RECORD CENTER

385-4664  
515 Phelps Ave.

Ch. 11 KCBD	Ch. 13 KLBK	Ch. 28 KMCC
6:30 * Emergency 7:30 * Saturday Morning Preview 8:00 * Raiders/Cowboys 10:00 * Weekend Wrap-Up 10:30 * Tonight Show 12:00 * Midnight Special 1:30 * News Weather Sports	6:30 * To Tell The Truth 7:00 * "Force Five" 8:30 * "The Gun of Autumn" 10:00 * Channel 13 News 10:30 * "C'mon Let's Live A Little" 12:00 * "World for Ramson"	7:00 * Funshine Saturday Sneak Peek 7:30 * "Roll, Freddy, Roll" 9:00 * ABC News Closeup 10:00 * KMCC News 28 10:30 * "Miss World, U.S.A."
Ch. 11 KCBD	Ch. 13 KLBK	Ch. 28 KMCC
6:45 * News Weather Sports 7:00 * Emergency Plus Four 7:30 * Sigmund 8:00 * Secret Life Of Walter Kitty 8:30 * Pink Panther 9:00 * Land of the Lost 9:30 * Run, Run, Run 10:00 * Beyond The Planet of the Apes 10:30 * West Wind 11:00 * Josie & Pussycats 11:30 * Gai 12:00 * World of Survival 12:30 * 11 Questions 1:00 * Baseball Game of Week 4:00 * World Series of Golf 5:30 * NBC News 6:00 * Porter Wagoner 6:30 * Lawrence Welk 7:30 * The Good Die Nashville Music 8:00 * Dean Martin Variety Show 9:00 * Miss America Pageant 11:00 * Weekend Wrap-Up 11:30 * "Fahrenheit 451" 1:45 * News Weather Sports	7:00 * Pebbly & Bom Bom 7:30 * Bugs Bunny 8:30 * Scooby Doo 9:00 * Shozon 10:00 * Far Out Space Nuts 10:30 * Ghost Busters 11:00 * Valley of the Dinosaurs 11:30 * For Albert 12:00 * CBS Film Festival 1:00 * Soul Train 2:00 * U.S. Tennis Classic 5:00 * Bobby Goldsboro 5:30 * CBS News 6:00 * Here Now 7:00 * All In The Family 7:30 * Big Eddie 8:00 * Mary Tyler Moore 8:30 * Dick Cavett 9:00 * Bob Corvetta 10:00 * Channel 13 News 10:30 * Sonny & Co. 12:00 * "Torpedo Alley"	7:00 * Hang Long Phooty 7:30 * Tom & Jerry 8:30 * The Lost Souther 9:00 * The New Adventure of Gilligan 9:30 * Uncle Croc's Black 10:30 * The Old Ball Couple 11:00 * Speed Buggy 11:30 * American Bandstand 12:30 * TBA 1:00 * "Young Fury" 2:30 * "The Lawless" 4:00 * Wide World of Sports 5:30 * Run 6:00 * NFL Season Game 9:00 * "Alcatraz Express" 10:30 * Saturday Late Movie

Beauty By Mary Kay Call: Freddie Duke 385-5064 1318 W. 14th  
Real Estate  
CORNER LOT 12 and 1/2 of 11, 17th St. across from First Christian Church. Call 246-3250, Amherst, TF-D  
24x104' Brick and Tile building, formerly Robert's Studio.  
3 bedroom, 2 bath, 2 car garage. Extra large home with storm cellar.  
Drive-in located in Anton, Texas. This business will make a good return on investment.  
2 bedroom, 1 car garage on West Second. \$5,000. Robert Richards Real Estate 385-3293  
loop 84, brick, 3 bedroom, 3 bath, walk-in closets, basement, one acre, fireplace. 385-4204 385-4919.

400 E. 14th St. 3 bedrooms, 2 baths, large living room, beautiful paneled den, lots of built-ins and closet space. Large enclosed patio with built-in stove, refrigerator and heating, ref. air-cond. unit, central heat, fenced back yard. Circular drive, rock garden, yard light, F.H.A. approved. Shown by appointment. Priced \$42,500. Call Mr. or Mrs. G.T. Sides, 385-3505. TF-S

**Bus Service**  
BISHOP PEST CONTROL  
Trees, Homes, Yards. 385-5492 or 997-5011  
Concrete Work  
Now is the time  
Call 385-6144  
Rosales Concrete  
Littlefield Office 410 LFD Drive Ph. 385-5149

**Color Contest Winners Named**  
SUDAN—First place winner of the Sudan Pay 'N Save coloring contest was Tammy Gore, according to store manager El Ray Rasco. Her coloring has now been forwarded to Amarillo to be judged along with over 300 other Affiliated Store first place winners. Tammy is the daughter of Mr. and Mrs. James Gore. Second and third place winners were Brad Byerley, son of Mr. and Mrs. El Ray Rasco, and Shelly Gore, the daughter of Mr. and Mrs. James Gore. Judges for the contest were Winifred Dykes and Jimmie Lou Davison.  
Changing Times  
At the time of the Revolutionary War, the average U.S. farmer used most of the same tools and followed many of the same practices that were in use during Biblical times.

**Color Contest Winners Named**  
SUDAN—First place winner of the Sudan Pay 'N Save coloring contest was Tammy Gore, according to store manager El Ray Rasco. Her coloring has now been forwarded to Amarillo to be judged along with over 300 other Affiliated Store first place winners. Tammy is the daughter of Mr. and Mrs. James Gore. Second and third place winners were Brad Byerley, son of Mr. and Mrs. El Ray Rasco, and Shelly Gore, the daughter of Mr. and Mrs. James Gore. Judges for the contest were Winifred Dykes and Jimmie Lou Davison.  
Changing Times  
At the time of the Revolutionary War, the average U.S. farmer used most of the same tools and followed many of the same practices that were in use during Biblical times.



# AROUND LITTLEFIELD

By CAROLYN WARREN 385-4232

AND MRS. Bill Owen had guests the past week, and Mrs. Murry Hart and her family from Bayou Batre, Ala. also visited Mrs. Sally in Lubbock. Murry is a daughter of both the Mrs. Owens. F. A. Fitzgerald and his daughter, Mary, are in a Hobbs hospital Wednesday until Sunday.

South Plains, Mr. and Mrs. W. H. Fitzgerald, Guinn, Betty and Shirley of Silverton, Mr. and Mrs. Homer Steen of Odessa, Mr. and Mrs. Herman Boyd of Odessa and Gary and Cathy Fitzgerald of Lubbock. JOELLA LOVVORN visited Saturday and Sunday in Farwell visiting her sister and brother and their families, the Bob Dollars and the M. D. Lovvorns. SUSAN HILL of Los Angeles, Calif. is visiting in the home of Mr. and Mrs. Pete Peterman. She is riding with the Sheriff's Posse in the grand entry at Boys' Ranch this weekend. VISITING Mrs. Doss Maner Thursday were Mrs. Pat McCarter and Mrs. Jackie Nichols

of Amarillo, and Diane Overland and Tosha and Brian of Lamar, Colo. MASTER SERGEANT and Mrs. Jerry Myers and children, Michael, Steve, Richard, David, Roger, Wayne, Dawn and Kevin were recent visitors in the home of Lee Messer. Mrs. Myers is the former Alevia Messer. They have just returned from a tour in Germany and are making their home in Tacoma, Wash. AMONG THOSE who have been in Medical Arts Hospital are Bert Wasson, June Ford, Johnnie Chapman and Betty Jordan. MR. AND MRS. Cordell Brown and sons, Bradley and Kendall of Manchester, Mo. visited this week with her



TRICYCLES and other play equipment have been donated to the Littlefield Satellite School For Special Children by Littlefield merchants: Nelson's Hardware, Western Auto, White Auto, Perry Brothers, Sears, and Hart-Thaxton Hardware. Shown with the items are, left to right, Tammy Bush, Howard Hayden, Junior Vargas, and Mark Davis. Standing in back are Paulene Dempsey, Roy Vargas, Lou Richards, Mae Blevins, Johnny Trevino and Rosendo Molina. (Staff Photo)

## SOCIETY CALENDAR

THURSDAY, SEPT. 4  
A BABY SHOWER honoring Sarah Renee Maxey, daughter of Mr. and Mrs. Charles Maxey, will be presented at 3:30 p.m. in the Fellowship Hall of the Spade United Methodist Church.



# RIDE A BUS TO THE WEST TEXAS BILLY GRAHAM CRUSADE

TWO BUSES WILL LEAVE AMHERST EACH NIGHT OF THE CRUSADE FROM IN FRONT OF THE POST OFFICE. THE BUSES WILL LEAVE AT 6:00 P.M. EVERYONE INVITED. NO CHARGE, RESERVED SEATS AT THE CRUSADE.

# THE CHURCH OF LITTLEFIELD

temporarily meeting at 116 E. 10th  
extends a warm invitation for you to come and worship the Lord with us this Sunday.

"GOD IS ALIVE, HE IS NOT DEAD"

"Jesus Christ, the same yesterday, today, and forever."

BIBLE STUDY 9:45 A.M. BIBLE FELLOWSHIP 6:00 P.M.  
MORNING WORSHIP 11:00 A.M. EVENING WORSHIP 7:00 P.M.

Pastor  
Claude Woods

mother, Mrs. Frank Allison. They also spent a few days in Ruidoso. They spent the weekend visiting in Amarillo with his parents, Mr. and Mrs. Kenneth Brown and Mrs. Allison's son and family, Mr. and Mrs. Don Allison.

SPENDING a few days in the home of Mr. and Mrs. Robert Bolton and family were Robert's nephew and his wife, Mr. and Mrs. Mike Hix, who were on their way from New Jersey to Arizona.

MR. AND MRS. Ross Lumden spent Friday in Amarillo visiting in the home of Carolyn and Jimmy Williams.

J. H. (Jim) Roles of Amherst, a former Littlefield resident, is a patient in Methodist Hospital in Lubbock. His son, Alvin of Santa Fe, N.M. is in Lubbock with his father.

VISITORS in the home of Mr. and Mrs. Wade Warren and family Wednesday were Wade's mother, Mrs. C. G. Warren and brother, Gary of Odessa.

MR. AND MRS. T. G. White of Anthony, N.M. visited this weekend in the home of their daughter and family, Mr. and Mrs. Byron Magruder, Byron and Cheryl.

VIRGINIA and Darwin Pierce of Carlsbad, N.M. spent the weekend with her mother, Mrs. Charles Calvert.

VISITING in the home of Mr. and Mrs. Wade Warren, Leslie Ann, Shannon and Jason last week was Carolyn's grandmother, Mrs. Joe McAlister of Vernon.

MR. AND MRS. Robert Bolton, Amy and Troy spent last weekend in Amarillo visiting with Mr. and Mrs. Jimmy Williams.

RECENT VISITORS in the home of Mr. and Mrs. Earl Milligan, Carolyn and Ronnie were Charlotte's mother, Mrs. Opal Haney, her sister, Rane Haney, and her niece, Shelly Butler of Claude.

PERRY COFFEY has had open heart surgery. He is in room 720 of Methodist Hospital

in Lubbock.

MR. AND MRS. Carroll Blackwell have been visiting their son in Llano, and went to Lexington to fish and visit with the Bob Bells.

## Comparing Children Leads To Frustration

Parents who compare their child's development to that of other children could be asking for frustration, says Mrs. Dorothy Powell County Extension Agent.

In comparing children, the parent assumes that his child will be normal ahead or underdeveloped. This is dangerous because it makes the parent begin setting standards for the child which might be unattainable.

This kind of situation can be avoided by remembering each child is an individual, developing at his own pace.

Parents can make the child's surroundings more stimulating and motivate him more to try new experiences. But it's still a matter of the child's own individual timing for when development takes place.

Parents have responsibility to be sensitive to stages infants should go through to develop socially, mentally and physically. Subtle guidance can be applied to help the child direct his energies, but over-control will fail.

The parents can remember to view his child as an individual growing according to his own game-plan. He can also provide varied experiences and changing surroundings that motivate growth.

## DIRECT DEPOSIT OF YOUR Social Security Check AT THE FIRST NATIONAL BANK IS EASY AS 1, 2, 3.....

1. Come in to the bank and sign a form SF-1199
2. We'll sign it and send it to Social Security District Office
3. Social Security will mail your check to us each month for direct deposit to your account

Easy, Convenient And Simple As 1, 2, 3.....

At

# THE FIRST NATIONAL BANK

OF LITTLEFIELD  
MEMBER FDIC

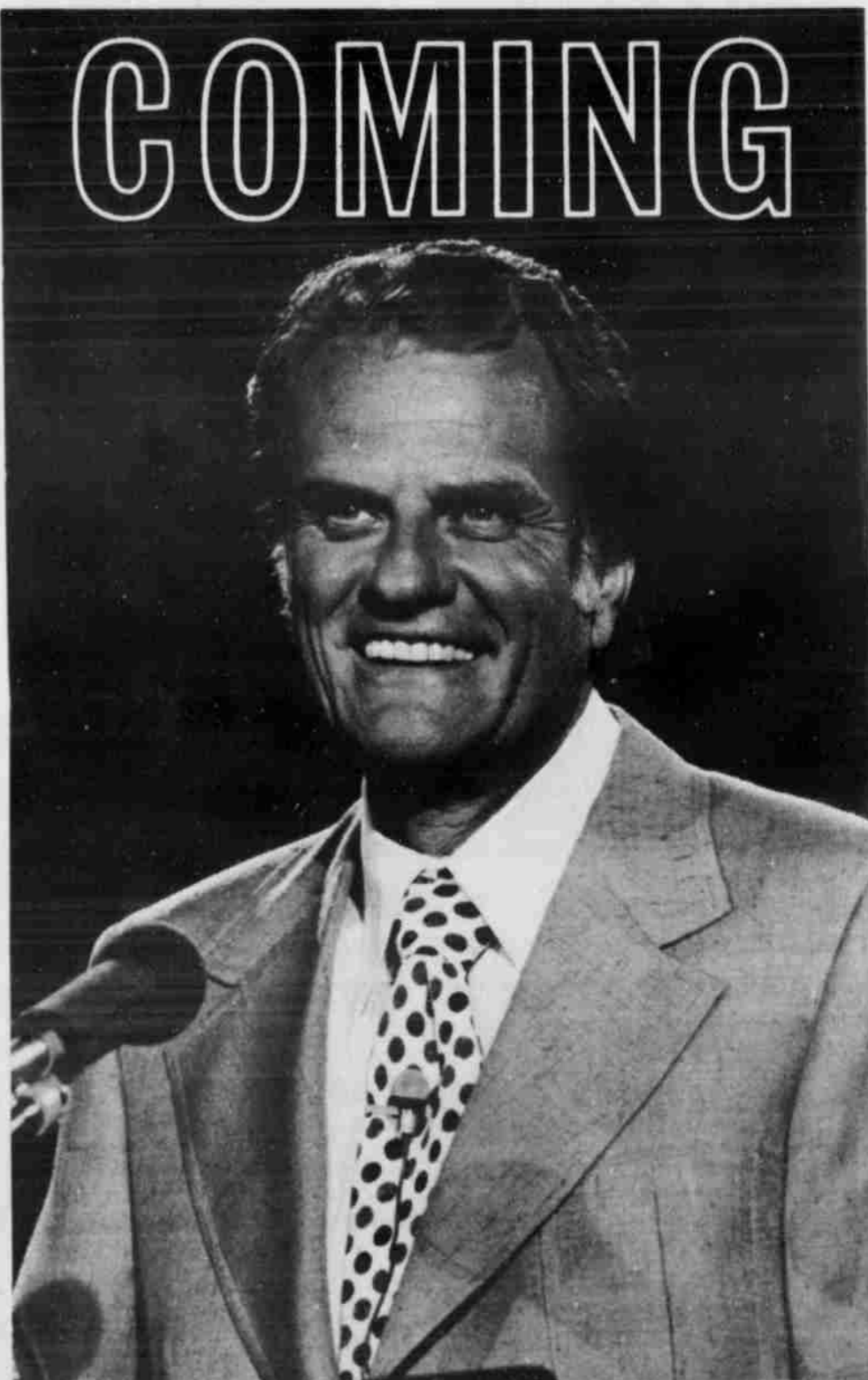

Beginning Aug. 31 through Sept. 7  
Nightly 8:00 pm

# WEST TEXAS BILLY GRAHAM CRUSADE JONES STADIUM LUBBOCK, TEXAS

ALL SEATS FREE

ASK ABOUT THE  
**SC** PREFERRED  
**LOAN PLAN**  
for **BIG MONEY**

Amount Financed	Finance Charge	Monthly Payment	Total Payments
\$2500.00	\$ 800	\$ 88.75	\$3300
\$4000.00	\$1280	\$110.00	\$5280
\$5000.00	\$1600	\$137.50	\$6600

48 MONTHLY PAYMENTS  
Annual Percentage Rate 14.34%  
These figures do not include insurance

Where's the money coming from? **SC** that's SIC CREDIT CO. where 420 Phelps Ave. 385-4492



### PUBLIC AUCTION

SAT., SEPT. 6, 1975, 1:30 P.M. CST, 1 MI. EAST OF EARTH, TEXAS AT WATERTOWER. WATCH FOR SIGN

BECAUSE OF ILL HEALTH THE DICK WATSON AUCTION TEAM HAS BEEN SELECTED TO SELL THE HOUSEHOLD ITEMS FOR MRS. LENA HITE.

Coldspot chest type deep freeze\* Frigidaire Refrigerator\* Westinghouse elec. range\* Two 3 pc. bedroom suites\* Large Sectional Couch\* Smaller Couch\* Love Seat\* Wrought Iron Table & Benches\* Packard Bell Stereo\* Wood desk\* Hoover Upright Vacuum\* Patio table and chairs\* Redwood picnic table & benches \* Lawn chairs & glider \* Crystal\* Silver trays\* Book Case\* Marble top table\* Carnival Glass butter dish and Pitcher\* Radios\* Chest of drawers\* Lots of pole lamps, swag lamps, etc. \*Lots of coffee, end lamp and bedside tables\* High Chair\* Swivel chairs\* Platform Rocker\* Automans\* Round table and eight chairs\* Large Mirror\* Huge lot pictures and frames including historical events\* Several sets sandwich plates\* Card tables and folding chairs\* Portable T.V.\* Wicker Chair\* Large lot sheets, towels, blankets, elec. blankets, etc.\* Elec. heaters\* Lots of dishes, pots and pans\* Huge amount of decorative items including statues, flowers, pots, silver ball, etc.\* Vases\* Books, dolls, bottles\* Japanese lantern\* Lots of records\* Wigs\* Metal stock tank\* Fire place baskets, throw pillows\* Huge amount of fine lady's clothing\* Much more.

#### OTHER AREA AUCTIONS

FRI., SEPT. 5, 1975—10:00 A.M. COST, 6419 S. UNIVERSITY, LUBBOCK, TX. GROCERY, CAFE, MEAT MKT. EQPT.

SAT., SEPT. 6, 1975—10:30 A.M. CST, 1 1/2 BLKS. N. TRAFFIC LIGHT, EARTH, TX. WASHATERIA EQPT. LOT AND BUILDING.

DICK WATSON - OLTON, TEXAS



SORE MUSCLES and aching bones resulted from Thursday night's tag football battle in Wildcat Stadium between the Littlefield Lions Club and the Early Risers Lions Club. Although the game was 0-0 at the close of the game, several dollars were raised to benefit the Littlefield Memorial Tennis Courts. (Staff Photo)



## SUDAN

BILLYE DOTY 933-2467

IT HAS BEEN reported that Mrs. G. W. Davis of Littlefield and formerly of Sudan has suffered several falls recently at her home. She received only bruises and soreness as a result.

RECENT VISITORS in the home of Mr. and Mrs. Henry Clarke have been her sister, Mr. and Mrs. Alfred Spell of Kenett, Mo. and her nephew and his wife, Mr. and Mrs. Erlin Gresham of Levelland. They all were in Ruidoso for a few days' rest and vacation. Spell is the pastor of the Penecostal Holiness church in Kenett.

MR. AND MRS. Raymond Gage were honored Sunday, Aug. 24, on their 45th wedding anniversary by their children and families. The Gages were married Aug. 24, 1930 in Shamrock and moved to Circle Back in 1931. Those attending were Mr. and Mrs. T. G. Gage, Duane, Paul and Donald; Mr. and Mrs. Dale Hanna and Mechele; Mr. and Mrs. Bob Gage and Dondi; Mr. and Mrs. Calvin Meissner, Jr. and Michael; Mr. and Mrs. Raymond Gage, Jr., Dempsey, Milessa, Jane and Joey, Mr. and Mrs. Mark Hanna, Mr. and Mrs. Raymond Davenport and Mrs. Helen Austin.

MR. AND MRS. Raymond Harper celebrated their 25th Wedding Anniversary Aug. 18. RECENT VISITORS in the home of Mr. and Mrs. Dick West were their daughters and sons-in-law, Mr. and Mrs. Gary Kelley of Dallas and Mr. and Mrs. James Snyatschk of Lubbock. They visited with them for several days and also visited their grandparents, Mr. and Mrs. Earl Chester, of Littlefield and other relatives.

SHAWN CHALKER, son of Mrs. Maxine Chalker, returned to his home in San Antonio Saturday after spending the past three weeks here with his grandparents, Mr. and Mrs. Milton Wiseman. They also visited in Platoro, Colo.

TOPS 634 met Monday, Aug. 25, at 3:30 in the community center with six members present. Roll call was answered with the number of pounds lost or gained with a 4 3/4 pounds loss recorded. The meeting adjourned after the group recited the TOPS pledge in unison.

MR. AND MRS. Waymon Gordon and Mr. and Mrs. Forest Powell were among those from

Sudan to attend the Pioneer Reunion Tuesday in Littlefield.

LYNN E. SLATE, 87, a Sudan Pioneer, died at about 9 a.m. Wednesday, Aug. 27, from a heart attack. He and his wife were residents of Amherst Manor at the time of his death. Their son, H. C. Slate of Luling had been visiting here with them.

MR. AND MRS. Paul Drum of Garland visited Saturday in the home of Mr. and Mrs. Martin Maxwell.

MR. AND MRS. Glen Testerman and girls have purchased the Mark Baker home at 401 Commerce formerly owned by Mr. and Mrs. Noel Lumpkin. The Testermans plan to be moving in soon.

MR. AND MRS. Jim Sorrells and son of Quinlan visited during the weekend in the home of her mother, Mrs. Weaver Barnett and with her sister, Mr. and Mrs. Joe Kent and Phil. Mrs. Barnett returned home with them for a visit and will also visit her mother in Fort Worth.

VISITING last week with the Blackie Seymores were 42 relatives including his uncle, Mr. and Mrs. Doc Seymore of Fresno, Calif. They were enroute to Abilene for a family reunion where the Seymores also attended as did Mr. and Mrs. Cotton Seymore, Mr. and Mrs. Dvan Seymore, Mr. and Mrs. Tommy Seymore and families.

MR. AND MRS. Glen Chester and boys returned home last week after vacationing at Red River, N.M. Tracey Bowling accompanied them.

MR. AND MRS. Wayne Doty and Donald were in Midland during the weekend to visit their daughter, Mr. and Mrs. Billy Wayne Gore. While in Levelland they met and visited Mr. and Mrs. Dale Read of O'Donnell, former Sudan residents.

MR. AND MRS. Ray May and Raegan were in Lost Cree, Colo., recently to visit their son and brother, Larry.

JIM FIELDS is among the Sudan students who enrolled at SPC in Levelland.

REV. M. V. SUMMERS returned home late Saturday from Camp Pendleton, Calif. where he was for the last two weeks for marine reserve camp.

MR. AND MRS. B. A. Beauchamp Jr. and Derwin

were in Lubbock to attend the celebration of the 25 wedding anniversary of Mr. and Mrs. L. J. formerly of Sudan.

JO GAYE DOTY, and Mrs. Dewayne Phillips of Lubbock visited during the weekend with Mr. and C. Ritchie in Midland. Mr. and Mrs. Morris McBea of Morton.

MR. AND MRS. Tom left Tuesday to accompany son and family, Mr. and Rodney Cate Shani and Lubbock to Pennsylvania.

They will be making their while he attends Penn State University.

MRS. C. W. Rossion is this week in Abilene to brother.

MRS. PETE (Tood) Littlefield, and her Sudan is a surgical patient at Methodist Hospital in Lubbock where she underwent Monday. She had been in unit there for several days was reported that as of she had improved.

MR. AND MRS. Pat left Saturday for vacation in Ohio, Pennsylvania and other points of interest.

MR. AND MRS. Actie recently returned vacationing in Georgia in Nashville, Tenn. where visited Opryland and other points of interest. The vacationed at Red River recently.

LT. RADNEY Fisher Phoenix, Ariz. visited last with his parents, Mr. and Lee Roy Fisher and Mrs. J. S. Smith fell ill at her home and hospitalized at the hospital with a back injury.

JOY GAYE DOTY and Phillips of Lubbock Thursday in the home of Mrs. Wayne Doty.

DAVID DOTY of Lubbock visited during the weekend the home of his parents, Mrs. Wayne Doty. He was to Midland Monday.

RECENTLY VISITING home of Mr. and Mrs. Kropp were her mother, Virgie Warren of Crosby, sisters, Mrs. Jewel Slaton, Mrs. Ruth White of Lubbock and Mr. and Mrs. Kropp and children of Lubbock.

## OUR SAVINGS ARE SHOWING ON EVERY FOOD SHELF IN OUR STORE

BLUE BONNET

OLEO LB 49¢

MORTON SALAD DRESSING QUART 89¢

BANQUET FROZEN DINNERS PACKAGE 49¢

ORCHID BATHROOM TISSUE 8 ROLLS \$1.09

CASCADE 99¢

SHURFINE COFFEE LB 99¢

SURE ANTI-PERSPIRANT DEODORANT 6 OZ 98¢

SHURFINE CORN NO. 303 CAN 2/59¢

CAULIFLOWER GREEN PEAS MIXED VEGETABLES SHURFINE FROZEN 10 OZ 3/\$1

COCA COLA 6 BOTTLE CARTON, 32 OZ \$1.59

SHURFINE POTATO CHIPS TWIN PAK 49¢

SHURFINE FLOUR 5 LB BAG 69¢

RUSSET POTATOES 10 LB BAG 79¢

COLORADO PEARS LB 29¢

GRADE A FRYERS LB 59¢

SHURFRESH WEINERS 12 OZ 69¢

CHOICE SIRLOIN STEAK LB \$1.59

We Reserve The Right To Limit Quantities. We Redeem USDA Food Stamps. We Give Gunn Bros. Stamps. Double Stamps On Tuesday & Wednesday With \$2.50 Purchase Or More Excluding Cigarettes.

# PIONEER SUPERMARKET



LEADING CHEERS for the Littlefield Lions Club Thursday night during the tag football bout between their team and the Early Risers Lions Club were 'Racquel' Billy Tom Grant and 'Dagmar' Benny Zahn. Their efforts were in vain, as the score remained 0-0 at the close of the game. (Staff Photo)

## Choirs Elect Officers For '75-76 School Year

The Choral Departments of Littlefield Junior High and High School have elected new officers for the 1975-76 school year.

Officers for the High School Choir are: President, Kim Wallace; vice president, Kevin Gardner; secretary-treasurer, Rachel Montalvo and chaplain, Ronald Parmer.

Junior High Choir officers are: president, Robert Wallace; vice president, Glenda Smith; secretary-treasurer, Mary Ann McGee and chaplain, Eddie Knox.

Both choirs are preparing to celebrate the nation's Bicentennial with unusual patriotic concerts consisting of pop and rock music.

The High School program will feature accompaniment by a rock group, and the Junior High show promises a personal visit from Uncle Sam.

The shows are scheduled for early October, and will be open to the area public for a nominal charge.



HIGH SCHOOL CHOIR officers for the 1975-76 school year are, left to right, Kim Wallace, president; Kevin Gardner, vice president; Raquel Montalvo, secretary treasurer; and Ronald Parmer, chaplain. (Personal Photo)



OFFICERS for the Junior High Choir for the 1975-76 school year are, left to right, Robert Wallace, president; Glenda Smith, vice president; Mary Ann McGee, secretary treasurer; and Eddie Knox, chaplain. (Personal Photo)



Bats or frogs are taken from the mouths of possessed persons in Nigeria, though no one knows what possessed them.

# CLEAR-OUT! DISCONTINUED SINGER SEWING MACHINES

Huge discounts! Limited quantities—including floor samples and demonstrators. Once these machines are gone, that's it...act now!

CLOSEOUT! TOUCH & SEW® Model 758 Sewing Machine

\$100 OFF

Orig. Price  
• 2-step built-in buttonholer • Wide range of interchangeable stitches • Exclusive SINGER® push-button front drop-in bobbin • Simple all-dial controls  
Orig. \$395.95 reduced to \$295.95 now \$295.95  
Carrying case or cabinet extra

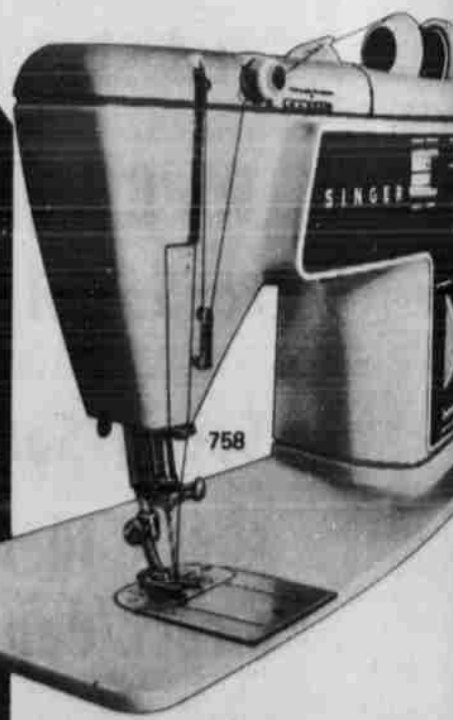

VACUUM CLEANERS-2 FOR THE PRICE OF ONE \$99.00

REPOSSESSED AND GOOD USED TRADE-INS

WE SERVICE ANY KIND OR MODEL OF SEWING MACHINES

BUTTON HOLE ATTACHMENTS TO FIT ANY KIND OF SEWING MACHINE, SINGER AND OTHERS

NEEDLES, BELTS, OIL, ETC.

We have a credit plan designed to fit your budget.



ROBISON SEWING CENTER 308 W 4th 385-4621

A Trademark of THE SINGER COMPANY



# DOLLAR DAYS



**POTATOES** ALL PURPOSE RUSSET 10 LB BAG **\$1.09**

**BELL PEPPERS** LARGE PODS FOR STUFFING, LB **29¢**

**CUCUMBERS** LONG GREEN SLICERS LB **23¢**

**TOMATOES** ASSORTED COLORS 6 IN. POT **\$3.29**

**LETTUCE** CALIFORNIA ICEBERG LB **33¢**

**ONIONS** MEDIUM SPANISH YELLOW LB **25¢**

**SIRLOIN STEAK** FURR'S PROTEN LB **\$1.39**

**ROUND STEAK** FURR'S PROTEN LB **\$1.39**

**CHUCK STEAK** FURR'S PROTEN LB **98¢**

**DELUXE RIBS** **79¢**

**GROUND BEEF** GROUND FRESH DAILY, LB **79¢**

**TURKEYS** TOP FROST HEN NEW CROP 10-14 LB AVG., LB **69¢**

**RIB STEAK** Furr's Proten Lb **\$1.39**

**RUMP ROAST** Furr's Proten Lb **\$1.19**

**CLUB STEAK** Furr's Proten, Lb **\$1.79**

**SHOULDER ROAST** Furr's Proten, Lb **\$1.09**

**RANCH STEAK** Furr's Proten 7-Bone Cut, Lb **\$1.19**

**CUBE STEAK** Furr's Proten, Lb **\$1.69**

**T-BONE STEAK** Furr's Proten, Lb **\$1.89**

**HAMS** Farm Pac Boneless, Lb **\$1.89**

**POTATO CHIPS** LAY'S TWIN P PACKAGE **79¢**

**RANCH STYLE BEANS** 15 OZ CAN **3 FOR \$1**

**VANILLA WAFERS** KEEBLER 12 OZ **59¢**

**PEAS** DEL MONTE SWEET NO. 303 CAN **3 FOR \$1**

**DRINKS** SHASTA, REGULAR OR DIET 12 OZ CAN **7 FOR \$1**

**PEETS** DEL MONTE PICKLED 303 GLASS JAR **43¢**

**SPINACH** FOOD CLUB NO. 303 CAN **4 FOR \$1**

**CAT FOOD** PUSS N'BOOTS FISH 15 OZ CAN **5 FOR \$1**

**APPLE SAUCE** FOOD CLUB NO. 303 CAN **3 FOR \$1**

**FOOD** Friskies, Ass't Flavors, Can **5 For \$1**

**TISSUE** Marina 4 Pac **79¢**

**DOUBLE GOLD BOND STAMPS**  
TUESDAY AND WEDNESDAY

★ YOU PAY THE LOWER PRICE AT FURR'S  
★ WE WILL NOT CHANGE A PRICE ON A MARKED CAN OR PACKAGE EXCEPT TO LOWER THE PRICE.  
★ ONCE PRICED... ALWAYS PRICED.

**VIENNA SAUSAGE** Libby's No. 1/2 Can **3/\$1**

**SPINACH** Food Club No. 303 Can **4 For \$1**

**ZUCCHINI** Del Monte No. 303 Can **40¢**

**SARDINES** Del Monte No. 303 Can **39¢**

**TOMATO SAUCE** Del Monte Tomato, 8 Oz **19¢**

**PEARS** Del Monte Halves, 8 Oz **33¢** No. 303 Can **49¢**

**DRINKS** DEL MONTE PINEAPPLE GRAPEFRUIT PINK PINEAPPLE GRAPEFRUIT, OR ORANGE, 46 OZ CAN **49¢**

**ORANGE JUICE** TEXSUN FRESH FROZEN 12 OZ CAN **39¢**

**LEMONADE** TOP FROST, FRESH FROZEN 6 OZ CAN **5 FOR \$1**

**POTATOES** GAYLORD SHOESTRING 20 OZ PACKAGE EACH **4 FOR \$1**

**CLASSIC PIZZA** Totino's Fresh Frozen, 21 1/2 Oz **\$1.95**

**CHARCOAL** TOPCREST 10 Lb Bag **89¢**

**CHARCOAL LIGHTER** Topcrest Fluid, 1 Qt **59¢**

**KLEENEX** Facial Tissue White Or Colors 200 Ct Box **39¢**

**SHAMPOO** Head & Shoulders 4 Oz Tube or 4 Oz Jar **\$1.09**

**SHAMPOO** BEACON STRAWBERRY, GREEN APPLE, APRICOT 16 OZ SIZE **63¢**

**DIAL DEODORANT** Regular Or Unscented 12 Oz **\$1.29**

**RISE SHAVE CREAM** REGULAR OR MENTHOL 6 1/4 OZ **59¢**

**KIMBIES** SHAPED DIAPERS NEWBORN 30'S **\$1.83**

**FACIAL CLEANSER** O.J.'S BEAUTY LOTION **93¢**

**RAZOR BLADES** SCHICK INJECTOR SUPER CHROME 4'S **73¢**

**TAME** Creme Rinse 16 Oz Size **\$1.57**

**SCOPE** MOUTH WASH 18 OZ **\$1.29**

**SHOP Furr's MIRACLE PRICES**



## Officer Elections Conducted At Anton

ANTON— Students at Anton Junior and Senior High School held elections for class officers Wednesday.

(Elected to lead their classes for 1975-76 were:

**Seniors:** President, James Melton; vice president, Ronnie Peacock; secretary, Willie Griggs; treasurer, Trinidad Rendon; and reporter, Danny Benton.

**Juniors:** President, Janette Bishop; vice president, Cindy Spears; secretary, Lisa Boothe; treasurer, Johnie Harper; and reporter, Lisa Hobgood.

**Sophomores:** President, Steve Green; vice president, Pam Bailey; secretary, Nancy Herrin; treasurer, Jimmy Davis; and reporter, Kathy Bailey.

**Freshmen:** President, Jeff Brazil; vice president, Bret Mills; secretary, Leesa Barnes; treasurer, Risa Stone; reporter, Sandra Griggs and sergeant-at-arms, Robert Nichols.

**Eighth Grade:** President, Eddie Rendon; vice president, Thomas Decker; secretary, Adele Castillo; and treasurer, Traci Butler.

**Seventh Grade:** President, Larry Wood; vice president, Herman Synatschk; secretary, Kevin Karvas; and treasurer, Jill Decker.

## Genealogy Research Course Set

Mrs. John Wood Jr. of Lubbock, a certified genealogist, will teach a course in "Genealogy Research" beginning Sept. 9 at South Plains College.

The class will meet from 7 to 10 p.m. Tuesdays for six weeks. Cost is \$20.

The genealogy course is one of nine community service short courses to be offered this fall by SPC's Division of Continuing Education.

Mrs. Wood was certified last August as a genealogist in American research by the Board for Certification of Genealogists. She is one of nine certified genealogists now living in Texas.

Mrs. Wood has taught classes for beginning genealogists at the Garden and Arts Center in Lubbock and also has given programs on "Using Family Tradition" and "How to Compile and Write a Family History."

She is the author of four family histories— "Kaleidoscopic Family Bass, 1769-1971," "Wood Works" in two volumes; "Knox Memorial" in two volumes and "Those Reeves Girls," also in two volumes.

Mrs. Wood will provide instruction on a number of topics.

Interested persons may register at the first class meeting in Conference Room 2 of the SPC Library. For more information, contact the Continuing Education Office at 894-2921, ext. 252.

## Mustang Tickets

### Now Available

Reserved seat tickets for the 1975 Mustang football season will go on sale in Olton Monday, Sept. 1st.

Persons who reserved seats last year will have through Sept. 12 to pick up their tickets.

On Sept. 15, all remaining tickets will be on sale to the public.

Tickets may be picked up at the business office in Olton.



# FREE

## YOUR PORTRAIT IN LIVING COLOR

ALL AGES

- ★ Babies ★ Children
- ★ Adults ★ Family Groups

LIMITED OFFER  
1 FREE PORTRAIT  
PER PERSON  
OR FAMILY

MINORS MUST BE ACCOMPANIED BY PARENTS

### Selection of Poses Taken

CHOOSE FROM FINISHED COLOR PORTRAITS NOT PROOFS

### What's The Catch?

THE FREE PORTRAIT IS GIVEN WITH THE COMPLIMENTS OF OUR STORE. THERE IS NO OBLIGATION TO BUY ADDITIONAL PORTRAITS, BUT WE HONESTLY BELIEVE THEY WILL BE SO GOOD, AND THE PRICES SO REASONABLE YOU WILL WANT ADDITIONAL COPIES

YOU MAY HAVE AS MANY SUBJECTS IN THE PICTURE AS YOU WISH. NO CHARGES OF ANY KIND ON THIS OFFER

Dress Them Up and Bring Them To:

**WESTERN AUTO**  
Wednesday, Sept. 3rd  
Photo Hours 11-5

# CABLE TV

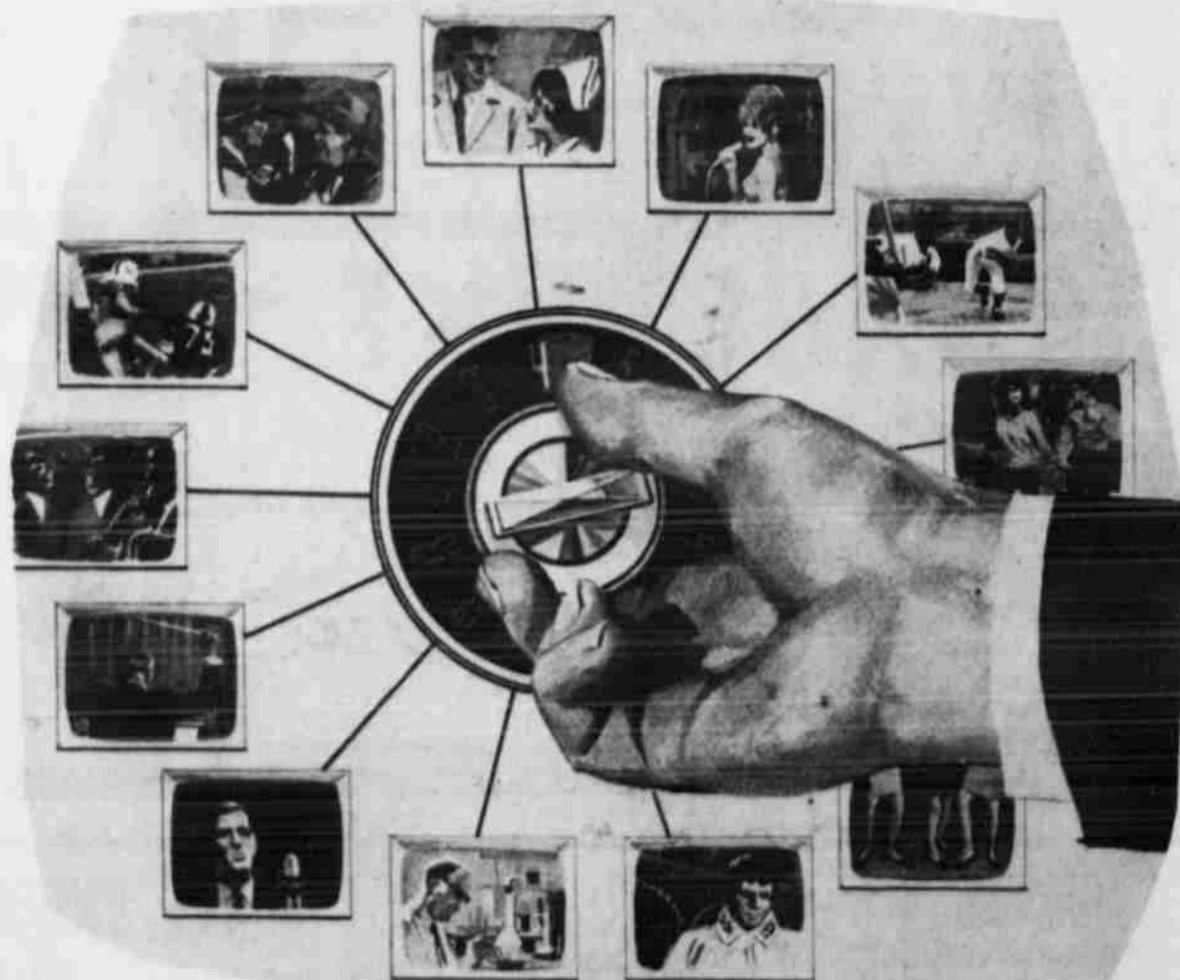

From: Littlefield Community Cable TV Service  
To: Non Subscribers Of Cable Service

We At Cable TV Believe There Are Quite A Number Of Littlefield Citizens Who Having Never Tried Our Eight (8) Channels Of Cable TV Service Are Not Aware Of The Variety And Choice Of Programs To Choose From By Being Able To Select From Eight (8) Channels On Cable TV.

In The Very Near Future Our Sales Representative Will Be Calling On You To Tell About A Special "Get Acquainted" Offer.

## Littlefield Cablevision Inc.

326-A PHELPS AVE.

385-4522

YOUR FURR'S IN LITTLEFIELD

# NOW



# OPEN SUNDAY

9: AM 'TIL 7: PM

FOR YOUR SHOPPING CONVENIENCE

**SWEET PEAS**

DEL MONTE  
NO. 303 CAN

3 FOR \$1

PLUS...  
YOU GET THE  
BONUS OF  
**GOLD BOND STAMPS**  
AT FURR'S...



VALUABLE COUPON  
THIS COUPON ENTITLES YOU TO  
**100 FREE**  
GOLD BOND STAMPS  
WITH ANY PURCHASE AT  
FURR'S IN LITTLEFIELD THIS  
SUNDAY ONLY  
LIMIT ONE COUPON PER FAMILY

**POTATO CHIPS**

LAY'S  
TWIN PACKAGE

79¢

**POTATOES** ALL PURPOSE  
10 LB BAG

**PEARS** WASHINGTON  
BARTLETT, LB 4 FOR

**T-BONE STEAK**

FURR'S PROTEN  
LB

\$1.89

**PLUMS** SANTA ROSA  
LB 3

**LETTUCE** CALIFORNIA  
ICEBERG, LB 3

**SIRLOIN STEAK**

FURR'S PROTEN  
LB

\$1.39

IN THIS AD  
EFFECTIVE  
SUNDAY  
AUG, 31, 1975  
IN LITTLEFIELD  
ONLY  
QUANTITY  
RIGHTS  
RESERVED  
NO SALES  
TO DEALERS  
PLEASE.



**Furr's**  
SUPER  
MARKETS





**FAITH IN AMERICA. . . . FAITH IN LITTLEFIELD!**

**We believe in the future of our country and our city. We strongly believe in the economic future of both. As a demonstration of our faith, we have tried to give you, our customers and friends, a truly pleasant atmosphere in which to shop. If you will do us the honor of paying us a visit in our newly remodeled store, we will do our utmost to make your visit as pleasant and friendly as we West Texans can.**

**HELP US CELEBRATE  
OUR GRAND OPENING  
BY REGISTERING FOR  
THESE DOOR PRIZES**

**Ware's**

**COME IN AND  
REGISTER. DRAWINGS  
WILL BE AT  
11 A.M.  
AND 4..30 P.M.  
MONDAY**

YOU NEED NOT BE PRESENT TO WIN

**THAT ARE  
LISTED HERE**

		Ladies Coat by Fashionbilt	Pant Suit by Jo Lester	Junior Petite Dress by P.B.J.	Junior Dress by Jerell		
Dress by Lillian Russell	Pant and Top by Ralph Original	Sterling Choker \$20.00 by Jaro	Sterling Choker \$14.00 by Jaro	Sterling Choker \$13.00 by Jaro	Sterling Choker \$12.00 by Jaro	Sterling Choker \$11.00 by Jaro	Ladies Jeans by Wrangler
Gown or Pajamas by Shadowline	Robe by Vanity Fair	Junior Dress by Te Jo	Billfold by Torrel	Belt by Torrel	Belt by Lyntone	Shaving Kit by Ely	Boys Jeans by Sedgefield
Bedspread by Blackburn	Tablecloth by Sunweave	3Pc. Towel Sets by Fieldcrest	Dress Length by Master Knitter	3 Yds. Velveteen by Crompton	Dress Length by Sylvan Looms	3 Pr. Scissors by Belding Corticelli	2 Sleeve Rolls by Belding Corticelli
Dress Hams by Belding Corticelli	Dress Length by Meridith Mills	Dress Length by Foxco	Dress Length by Logantex	Dress Length by Kaytex	Dress Length by Carltext	Pant & Shirt Set by Gearworks	\$20 Garment by Dotty Dan
Overalls Set by Baby Bliss	Infant Dress by Bryan	6 Shirts Sizes 3 to 7 by Tom Sawyer	6 Pr. Knee Socks by McCubbin	Dress by C. R. Asfahl	4 Shirts Sizes 3 to 7 by Donmoor	1 doz. shirts (2 per winner) by Arrow	1 Pr. Slacks by Mel Rose
	4 Shirts by Eldorado	Leisure suit by Warren Sewell	Sport Coat by Curlee	1/2 Mens Socks by McCubbin	1 doz. Mens Socks by Interwoven	Drizzler Jacket by McGregor	
	Slacks by Jaymar	4 Shirts by Career Club	Men's Jeans by Sedgefield	4 Shirts Sizes 8 to 20 by Donmoor	4 Shirts Sizes 8 to 20 by Tom Sawyer	1 Pr. Mens Shoes by Florsheim	
	1 Pr. Mens Shoes by Rand	2 Pr. Ladies Shoes by Joyce	2 Pr. Shoes by Miss America	1 Pr. Shoes by LaMancha	1 Pr. Sandals by Bernardo	Pant and Jacket Set by Rhodes	





- DR PEPPER** 6 BOTTLE CARTON 32 OZ \$1.28
- COCA COLA** 6 BOTTLE CARTON 32 OZ \$1.33
- BABY BOTTLES**
- SHORTENING** SNOWDRIFT, PURE VEGETABLE, 3 LB \$1.69
- TEA** WHITE SWAN INSTANT, 3 OZ JAR \$1.09
- QUICK TUNA** NESTLE, 32 OZ \$1.88
- GREEN BEANS** DEL MONTE, CHUNK LIGHT 6 1/2 OZ CAN 49¢
- CORN** WHITE SWAN, WHOLE KERNEL OR CREAM STYLE, 17 OZ CAN 4 FOR \$1
- FRUIT DRINK** WAGNER, ALL FLAVORS, QUART, EACH 3 FOR \$1
- BATHROOM TISSUE** FAMILY SCOTT, 4 ROLL PKG 69¢
- TOMATO SAUCE** DEL MONTE, 8 OZ CAN 6 FOR \$1
- CHILI FLOUR** WOLF, 19 OZ CAN 88¢
- BLEACH** GLADIOLA, 5 LB BAG 79¢
- SPINACH** PUREX, GALLON 69¢
- RANCH STYLE BEANS** DEL MONTE CHOPPED, 15 OZ CAN 4 FOR \$1
- MACARONI DINNER** KRAFT, 7 1/4 OZ 3 FOR \$1
- POTATO CHIPS** PRINGLES, TWIN PAK, 9 OZ 3/89¢
- CEREAL** KELLOGG'S, CORN FLAKES, 18 OZ 89¢
- TOWELS** SCOTT, LARGE ROLL 56¢
- DEODORANT** PROTECT ANTI-SPRAY-MIST, 4 OZ \$1.79

- FRUITS & VEGETABLES
- BANANAS** Dole Golden Ripe, Lb 17¢
  - AVOCADOS** Calif. Hass Variety, Large Size, Each 3/78¢
  - GRAPES** Thompson Seedless, Lb 39¢
  - CARROTS** Calif. 1 Lb Cello Bag 2/29¢
  - POTATOES** Russett, No. 1, 10 Lb Bag 98¢

- BACON** DECKER SLICED SLAB, LB \$1.59
- HAM** GLOVER'S SMOKED SHANK PORTION, LB 89¢
- HAM** GLOVER'S SMOKED BUTT PORTION, LB 98¢
- CHEESE** SALAD MAKER, LB 69¢
- GROUND BEEF** USDA CHOICE, LB 77¢
- CHICKEN FRIED STEAK** BLUE MARROW, LB 99¢

- 6 PAK CANS 72 OZ 97¢
- 6 PAK CANS 72 OZ 97¢
- 3 FOR \$1

VARIETY

- ORANGE JUICE** Flav-R-Pac, 6 Oz Can 4/\$1
- GERMAN CHOCOLATE CAKES** Colonial, 25 Oz \$1.19
- FISH FILLETS** Booth, 12 Oz 88¢
- SHRIMP** Booth Breaded Fantail, 1 Lb Box \$2.29
- DINNERS** Banquet, 11 Oz 2/\$1

QUALITY

- HALF & HALF** Plains, Pint 3/\$1
- WHIPPING CREAM** Plains, 1/2 Pint 3/\$1
- BUTTERMILK** Plains, 1/2 Gallon 67¢
- COTTAGE CHEESE** Plains, Diet, 16 Oz 67¢
- ICE CREAM** Plains, Round Carton, 1/2 Gallon \$1.19

- SPRAY N WASH** TEXIZE, 16 OZ \$1.09
- HOME OWNED-HOME OPERATED

# LITTLEFIELD SUPER MARKET

## ENOCHS

MRS. ALMA ALTMAN

VISITING in the home of Mrs. Altman were her children from Tulsa Mr. and Mrs. Kenneth Millsap and their daughters, Kena and Valerie.

MR. AND MRS. Harold Layton and son Robert, and Mr. and Mrs. Dale Nichols from Maple, Donnie and Paula all spent a week at Red River, N.M.

VISITING in the home of Mr. and Mrs. Charlie Shaw were Mr. and Mrs. Danny Shaw of Post and Mr. and Mrs. Ralph Juarros and two sons of Las Vegas, N.M. Ralph returned home on Monday but his wife and sons remained here for a few days.

LITTLE KOBY Abney son of Mr. and Mrs. Harrold Abney of Channing is spending this week with his grandparents Mr. and Mrs. W. B. Peterson.

VISITING in the home of Mrs. Josie Vanlandingham are her children Mr. and Mrs. Lawrence Hall and their two little granddaughters all of Anaheim, Calif. They are also visiting his father Mr. Carl Hall and others of the family.

MR. AND MRS. Kenneth Coats and their family held their annual get-together at Ritos. Mr. and Mrs. Coats, Kerry Wane and Levelland, Mr. and Mrs. Coats of Hobbs, Mr. Robert Jones of Coats and Kim all attended visiting there were Mr. R. H. Baker, Rodney Sharita.

VISITING in Enochs and Mrs. Lloyd Crosby Littlefield. They visited Altman.

RAYNETTE SHAW Santa Clara, Calif. is in the home of her grandmother Mr. and Mrs. J. O. D. grandmother has been and her granddaughter to help take care of her.

MR. AND MRS. Vanlandingham and Lubbock visited their Mr. and Mrs. E. N. Enochs.

MR. AND MRS. and their family visited home of their mother Winnie Byars. On Sunday all went to Friona to visit son and brother, Mr. Tom Byars and family.

### Anton Lions Club, Wives Hear Mgr.

ANTON— Mickey Brewer, personnel manager for the American Cotton Growers' Textile Plant, was guest speaker for the Anton Lions Club ladies' night Monday.

Brewer used a slide program to show the plant and equipment that will be used in Littlefield. He said that when the mill is in full production, workers would be on a 24-hour schedule with two 12-hour shifts.

He was accompanied by Bob Jones, who recently moved from South Carolina, to be in charge of training the plant employees. Jones is an industrial engineer. Bill Adams, Littlefield Chamber of Commerce, introduced the speaker.

During the business session, Eddie Bishop, president, presented a Lions District 2-T2 banner to Tomoko Japanese exchange student. He announced that the Club would have ladies' night Monday of the district governor will be his official visit to the club Sept. 15 meeting.

Lions International is a drive for used eggs. They need 117,000 used which they will use in program on sight.

The Lions Club will sponsor the tennis tournament to be held Aug. 29-Sept. 1, benefit of the tennis building program.

The club is having a Lions pin produced which a white rabbit with "City—USA" and the emblem on it.

### Maid Of Cotton Contest Scheduled Oct. 17-18

Richard Lackey, chairman of the Maid of Cotton Committee at the Lubbock Chamber of Commerce, has announced that the dates for this year's South Plains Maid of Cotton selection will be Oct. 17 and 18.

The selection finals will be broadcast over Lubbock's KMCC-TV station at 9 p.m. Saturday, Oct. 18. The selection will be the ending of two full days of activity for the girls.

On Friday, Oct. 17, the girls in this year's selection will be presented at a formal ball. The ball will be the social highlight of the year for the members of the local cotton industry.

Lackey said that the following requirements must be met by all the girls wishing to enter: single girls, age 19 to 23 and at least five feet five inches in height. He also emphasized that to be eligible for entering the girl must come from a cotton producing county.

Deadline for entering this year's selection is 5 p.m. on Sept. 30, 1975.

The contestant selected as the South Plains Maid of Cotton will have weeks of preparation for the national finals in Memphis, Tenn.

This preparation will include many personal appearances throughout the South Plains area, fitting and selection of a wardrobe, as well as a complete backgrounding in cotton. This will include a tour of the "Super Gin," tours of the Textile Research Center, the Cotton Seed Flour Mill, and formation on all other aspects of cotton and cotton handling South Plains.

Anyone having questions wanting to enter should contact Dick Moseley at the Lubbock Chamber of Commerce, 4666 or write to Box 10, Lubbock, Texas 79408.



PLACIDO RODRIGUEZ Airman Candidate For Training

Airman Placido Rodriguez of Earth, has been selected for technical training the U.S. Air Force communications field at Lackland AFB, Texas. The airman recently completed basic training at Lackland AFB, Texas. Airman Rodriguez is a graduate of Springdale High School.

### KIRBY SALES & SERVICE THINGS YOU SHOULD KNOW ABOUT YOUR KIRBY...

...When Should You Change The Belt?  
 ...When Should You Clean Out The Motor?  
 ...If Your Light Comes On But The Motor Won't?

For The Answers, Call  
**385-3357**  
 Lloyd White Area Distributor  
 "Phone Day or Night, Call White"



# New Hospitals, Facilities Must Comply With Regulations

new or expanded nursing homes or facilities may not be able to receive clearance from Texas Health Facilities Commission, cautioned Chairman Melvin Rowland of Uvalde, Chairman; Renal B. Rosson of Snyder, Vice-Chairman; and P. Bolin Mahaffey of Corpus Christi, Member, head the new state agency whose general duties include administering a state certificate of need program.

According to Commissioner Rowland, the initial actions of the Commission have been to develop procedures where projects under development on May 28, 1975, the effective date of the law, many receive prompt consideration. In writing the law, the Legislature recognized that projects were under development and made provisions whereby Certificates of Exemption or Declaratory Rulings could be issued by the Commission for those ongoing or pending projects. A period of 120 days, beginning May 28, 1975, was provided by the Legislature for the filing of Applications for the Exemption Certificates or pending projects.

In other provisions of the law, the Legislature mandated the Commission to establish rules and procedures whereby Applications will be considered for a Certificate of Need for those projects which are ineligible for an Exemption Certificate or Declaratory Ruling. The law established the Certificate of Need process, and laid out specific procedures whereby facilities must submit an Application to the Commission for modifications, changes in size, direct health care services, and equipment.

The Commission must then respond to the Application by holding a Public Hearing on the need for that project in the community not earlier than the 61st day or not later than the 70th day after receipt of a completed Application.

Following the completion of the Hearing, to be conducted by a Hearing Officer who is a licensed attorney in the State of Texas, the Commission must then render its final determination in not less than 90 days following the receipt of the completed Application.

In the development of the procedures and the rules for the conduct of its business, the Commission is drafting proposed rules for public comment. It is expected that the proposed rules will be circulated within the next 30 to 60 days for public hearings and comment prior to publication. According to Commissioner Rowland, a series of hearings will be conducted at several locations around the State in order to invite the broadest participation by interested parties.

After these hearings, the rules of the Commission will be published. After issuance of these rules, the 75-90 day process outlined above will be required before decisions on applications can be rendered.

Ed Jennings 385-4489

Southern Farm Bureau Life Ins. Co. I have recently changed my employment situation and am now self-employed. Is there any way to receive tax-saving deductions and set up a pension plan for myself?

Yes. Under the Pension Reform Act of 1974, you may now receive many of the tax benefits enjoyed by employees of corporations. For retirement plan purposes... you are both an employer: being permitted to set aside up to 15% of earned annual income or \$7,500, whichever is greater, toward a pension plan... and an employee: not being taxed on such contributions or on the income earned by the funds during the accumulation period. To receive these benefits, you need to be under a qualified Keogh plan. Life insurance plans can pay retirement income as long as you live and pure insurance proceeds in such a plan are received by your beneficiary free of income taxes.



## Field Day Sept. 9 At Lubbock TAES

Two top money makers in the South Plains agricultural spectrum, cotton and grain sorghum, will be featured here Tuesday, Sept. 9, as the Texas Agricultural Experiment Station kicks off its 66th Annual Field Day.

Some 120 varieties of cotton in irrigated, dryland and special glandless field tests are set for exhibition, reports Dr. Earl Minton, field day committee chairman. Also, a review of grain sorghums with bred-in resistance to greenbug damage will be presented by one of the hybrids originators, Dr. Jerry Johnson, TAES sorghum breeder.

Dr. Levon Ray, cotton geneticist, is scheduled to present the cotton variety portion of the field day program.

Field day activities begin at 1:00 p.m., with a 10:00 a.m. continuing until 5:00 p.m. Tours via tractor-pulled trailers will leave the Experiment Station headquarters every 15 minutes throughout the afternoon.

Says Ray, visitors will be able to view 61 varieties of irrigated cotton, 44 varieties on dryland and a special field test evaluating the performance of 16 glandless cotton varieties. Varieties are evaluated under conditions of severe verticillium wilt and in narrow row plantings, notes the researcher. Information gathered on lint and seed yields, fiber properties gin turnout and other characteristics will help producers in selecting a cotton variety for next season.

"Our field day tour will not only afford a first hand opportunity to compare cotton varieties growing side by side, but also to discuss important attributes of varieties including several new varieties just coming on the market," says Ray.

Discussing the genetics of the greenbug resistance hybrids, Johnson says, not only do the resistant hybrids have fewer greenbugs than the hybrids presently on the market, but they are able to tolerate larger numbers before sustaining leaf injury from a toxin injected by the insect.

In 1974 tests resistant hybrids produced 5,500 pounds per acre. Grain yield of susceptible hybrids was reduced by almost 50 percent, from 5,500 pounds to 2,600 pounds where the insects were not controlled, the TAES scientist reports.

Johnson will also be on hand to demonstrate the greenbug resistant sorghum varieties at the Experiment Station at Halfway's Field Day scheduled two days after the Lubbock event, on Sept. 11. Halfway field day activities begin at 1:00 p.m. running until 5:00. Halfway field day activities begin at 1:00 p.m. running until 5:00. The Halfway center is located 14 miles west of Plainview on Hwy 70.

The 275-acre Lubbock station, which houses TAES and Extension staffs, USDA-ARS personnel and the agricultural meteorologist of the National Weather Service, is located 7 1/2 miles north of the city on Hwy 87, just north of the Lubbock Regional Airport.

## AMHERST

MRS. MARY E. Britt's sisters, Mrs. A. G. Somers and Mrs. G. D. Bearden of Lubbock spent Thursday to Sunday with her. Other guests Sunday were Mrs. Esther Lee Criswell, her son Mr. and Mrs. Don Criswell and Larry of Lubbock.

V. L. YARBROUGH of Plainview visited his sister, Mrs. Mary E. Britt Wednesday and her daughter, Mr. and Mrs. Nolan Harlan of Bula were here Thursday.

MR. AND MRS. E. E. Gee returned home from their vacation at their cabin near Eagle, Nest, N.M. The Don Ewings were their guests for the weekend.

MR. AND MRS. Roger Britt are visiting friends in Minnesota.

MR. AND MRS. B. W. Briggs and his parents, Mr. and Mrs. Pat Briggs, are on vacation. Phil Hargress of Littlefield took B. W.'s place at Church of Christ Sunday at both services and will next Sunday.

JIM ROLES is scheduled for major surgery Tuesday at Methodist Hospital, Lubbock.

MRS. W. P. Davis of Amarillo is visiting her sons, Pete and Bill and friends and to attend the Lamb County Pioneers' meeting Tuesday.

MR. AND MRS. H. C. Slate and her brother, Johnny Wade of Luling, are visiting the L. E. Slaters at Amherst Manor.

REV. AND MRS. Harold Brantley and two sons of Columbus, Ohio are spending several days with his parents, Mr. and Mrs. Harry Brantley.

KENNETH RHODES and son, Greg and daughter, Julie of San Diego, Calif. are visiting his mother, Mrs. Agnes Rhodes this week. They arrived Monday.

GEORGE (Wart) Williams is in Lubbock for a check-up this week.

MR. AND MRS. Sam Harmon have returned from a visit with her parents in Redding, Calif. Kim accompanied them as they went by way of Las Vegas, Nev. He came home earlier and went to Knoxville, Tenn. and attended National convention of the fraternity of which he is a member of West Texas State University at Canyon.

MRS. ESTHER Rowland of El Paso visited her brother, Jay Lyles and other relatives during the weekend.

MRS. VIRGINIA TURNER and her mother, Mrs. A. F. Copeland were Morton visitors early last week.

AVAILABLE LIGHTING For an older person's maximum safety, the interior of a home requires a minimum of one permanent lighting unit per room. It should be switch-controlled at each room entrance.

SEPT. DOLLAR DAY PRICES GOOD MON.-TUES.-WED. AS LONG AS QUANTITIES LAST!

# JCPenney

## DOUBLE KNIT CREPE

NEW SHIPMENT

\$1.99

### NEW FALL COLORS

100% POLYESTER DOUBLE KNIT CREPE IN NEW FALL COLORS. DUSTY PINK, DUSTY GREEN, RUST, MAROON, DARK GREEN, HOT PINK, ROYAL BLUE, COPEN BLUE, BLACK, NAVY, OFF WHITE

OUR BEST SELLING POLYESTER DOUBLE KNIT IN 1974 AT \$3.99 A YARD.

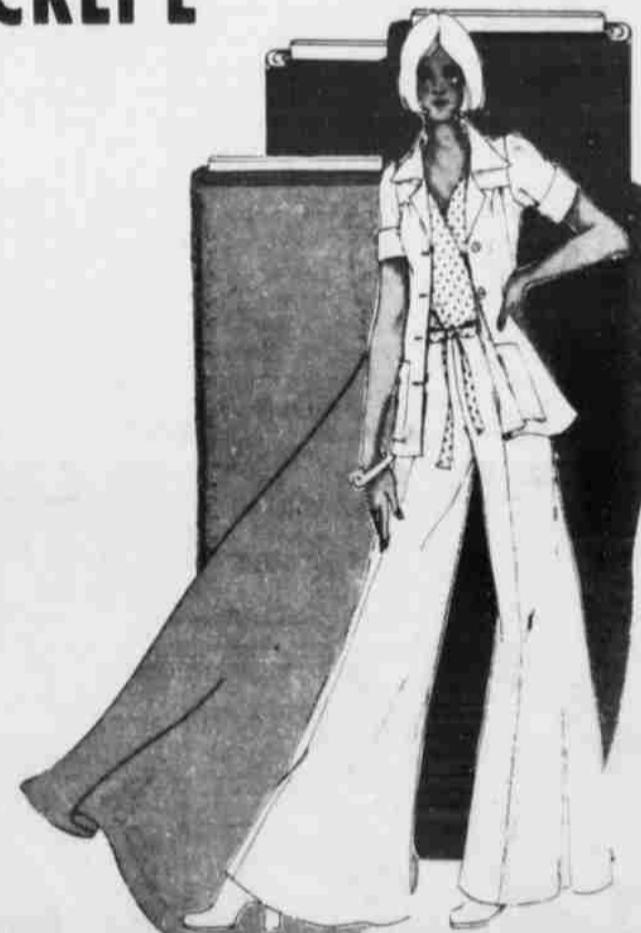

NEW SHIPMENT SOLID & FANCY

## 100% POLYESTER DOUBLE KNIT

1000 YARDS OF BEAUTIFUL SOLID AND FANCY DOUBLE KNIT.

\$1.44

3 DAYS ONLY

SHORT LENGTHS

GOOD COLOR SELECTION

## KNITTING YARN

50¢ SKEIN

100% POLYESTER SOLID & FANCY

## WOMEN'S FLARE LEG PANTS

\$3.99

WARM FUZZY EAR MUFFS Lots Of Colors

\$1.00

MEN'S NYLON WINDBREAKERS Hidden Zip-Out Hood

\$2.99

SEAMLESS MESH PANTY HOSE Short-Average-Long

3/99¢

MEN'S CHAMBRAY WESTERN SHIRTS Blue-100% Cotton

\$4.99

WOMEN'S KNEE-HI SOX Plaids & Argyles

77¢

MEN'S POPLIN BUSH JACKETS 3/4 Length Sizes L & XL

\$3.99

WOMEN'S VINYL LOAFERS Black-18 Pairs

\$2.44

MEN'S KNIT GOLF SHIRTS 100% Polyester, Reg. 55-57

\$3.99 & \$4.99

CHECK BATH TOWELS Yellow Only, Reg. \$2.79

\$1.66

MEN'S KNIT SPORT COATS Dark Solid Colors

\$19.88

WOMEN'S JAMAICA SHORTS 100% Polyester

\$1.00

BOYS' PLAID FLANNEL SHIRTS Penn Prest Plaids

\$2.99

GIRLS' KNEE-HI SOX Solid Colors

2/99¢

BOYS' RAG STITCH JEANS Size 8 to 12

\$7.50 \$8.50

WOMEN'S COAT CARAVAN For A Limited Time

BOYS' CREW KNIT SHIRTS Long Sleeve Solids

\$2.99

### HIGH SCHOOL STUDENTS SAVE ON CLASS RINGS DELIVERY 2-4 WEEKS

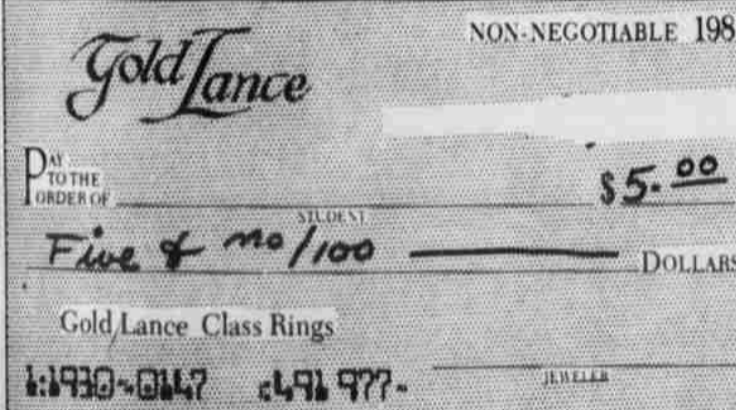

Save \$5.00 Bring this special "check" by store today. Beat the higher gold prices coming.



This special "check" does the job. Be first in your class with a GOLD LANCE RING.

Patt's Jewelry 5th & XIT

## SAVINGS

### DOLLAR DAY VALUES

BOYS' LONG SLEEVE KNIT SHIRTS 2-6 30% OFF

GIRLS & BOYS PANTS 2-6 30% OFF

ONE GROUP SUMMER CLOTHING 1/2 PRICE

ONE GROUP GIFT SETS 1/2 PRICE

NEW WINTER CLOTHING ARRIVING DAILY-REMEMBER OUR NEW COMPLETE LINE OF HEALTHTEX AND MARTHA MINIATURE CLOTHING. ALSO WE HAVE A COMPLETE SELECTION OF SOFT SOLE BABY SHOES AND BOOTIES.

## PIERCES' SPECIALTY SHOP

331 PHELPS AVE.

## SAVINGS



## STATE CAPITAL Highlights AND Sidelights

by Lyndell Williams  
TEXAS PRESS ASSOCIATION

**AUSTIN** — Campaigns for and against a new Texas constitution are getting off the ground.

Proponents of the far-reaching revision to be voted on November 4 have opened an Austin headquarters under the direction of former State Supreme Court Chief Justice Robert W. Calvert and State Rep. Ronald Earle of Austin.

Opponents, for the time being led by State Sen. Peyton McKnight of Tyler, are setting up shop in an office building across the street.

First copies of a proposed voter's guide to the revision document were placed in the mail last week. They present complete text of the eight propositions to be voted on, with a comparison summary of the "old" and "new" constitutional provisions.

Acknowledged opposition has centered largely on the proposal for annual sessions of the legislature — a 140-day session during odd-numbered years and a 90-day meeting on even-numbered years.

House Speaker Bill Clayton and Lt. Gov. Bill Hobby, concerned over effect of the opposition, asked an attorney general's opinion on whether the short, even-year session could be limited by law or legislative rule to budgetary and emergency matters.

Their proposal immediately stirred strong disapproving comment from both proponents and opponents of revision, indicating, perhaps, a hot campaign during the next three months.

### Ouster Rules Drawn

A Senate committee approved rules for the impeachment trial by 31 senators of 229th District Judge O. P. Carrillo September 3.

Carrillo personally appeared at the committee hearing with his attorneys, Leon Jaworski, the former Watergate prosecutor, who will be special counsel to the Senate presiding officer, urged proceedings be conducted "on a high plane in strict accord with the rules."

The committee tentatively approved live broadcast news coverage of the trial and recommended a gag rule to restrict comment by senators on proceedings in which they sit as court and jury.

Carrillo subsequently has been indicted by a Jim Wells County grand jury. He already faced a September 8 trial date on an income tax case in federal court at Corpus Christi and an October 2 hearing by a Judicial Qualifications Commission master in removal proceedings.

### Allowable Wide Open Again

The Railroad Commission set the oil allowable for the 42nd straight month at 100 per cent of potential.

Commissioner Jim Langdon said a 15 per cent shortfall is expected in interstate gas pipelines this winter.

Any action by the federal government to take Texas gas reserves to make up for shortages in other states would amount to "a rape of Texas," Langdon commented.

"If it is a cold winter, and indications are that it will be, things are going to be pretty tough, gentlemen," Langdon told oil and gas company representatives at the Commission's meeting to set the allowable.

### AG Opinions

A state representative who intentionally charges expenditures to the state in excess of the authorized amount is subject to prosecution under the penal code, Atty. Gen. John Hill held.

In other recent opinions, Hill concluded:

- Teachers cannot be school board members in the same district which employs them.

- Beginning September 1, judges must contribute six per cent of their annual compensation paid by the state to their retirement fund, legislators eight per cent.

- A motion for discovery rather than the Open Records Act is the appropriate means for access to information in a welfare recipient's case file concerning pending criminal charges against him.

- There is no law authorizing Wharton County to cease operation of the county's Nightingale Hospital, other than by lease.

- Texas Board of Dental Examiners may not require dental assistants to register with the Board and pay an annual fee nor permit employment of more than one dental hygienist per dentist.

- A member of the board of commissioners of the Port of Houston Authority may also be a member of the Texas Amusement Machine Commission.

- A board of regents may not compel a college faculty member or employee to take a leave of absence without pay while campaigning for public office in a school district, city or other local governmental district, but may require that for candidates for any other public office.

- Information on inventories from grain warehouse reports of the Department of Agriculture is not subject to disclosure under the Open Records Act.

### Appointments

Gov. Dolph Briscoe named Dr. June Hyer of Seabrook, Howard Richards of Beaumont and John Fainter of Houston to the economy-hunting Joint Advisory Committee on Government Operations.

Briscoe appointed James H. Keeshan of Montgomery as district attorney for the ninth district (Montgomery, Polk, San Jacinto and Waller counties), and K. Baker of Carthage as 123rd district judge (Shelby and Panola counties).

The Governor picked Rudy Day of Dallas as chairman of the new Texas Committee on Indochinese Resettlement.

He reappointed Dr. Everett D. Wilson, of Huntsville and Dr. John Mack Prescott of College Station to the State Board of Examiners in the Basic Sciences.

Cadar Parr of Irving September 1 becomes associate commissioner for occupational education and technology.

### Short Snorts

State Highway and Public Transportation Commission received \$17.1 in public transportation fund requests from San Antonio, Beaumont, Galveston, Corpus Christi, Lubbock and Amarillo.

State Board of Insurance approved a joint plan by Texas insurance companies for providing malpractice coverage to hospitals and doctors.

A legislative public health sub-committee recommended doctors be relicensed every five years to insure their keeping up with the times.

Comptroller Bob Bullock said 31 retail firms shut down for back sales taxes owe more than \$1 million which will be recovered by the state and cities.

# Texas Vegetable Production Worth About \$52,566,000

Despite drought in some areas and excessive rain in others, Texas vegetable production during the 1975 spring quarter is expected to be worth \$52,566,000, according to Agriculture Commissioner John C. White.

According to recently released Texas Crop and Livestock Reporting Service figures Texas will lead the nation in production of cantaloups.

Total value of the 1975 Texas cantaloup crop is expected to be \$15.9 million, up from last year's \$11.2 million crop. Production will be approximately 1,020,000 pounds per hundredweight, compared with last year's production of 855,000 pounds per hundredweight. Harvested acreage is 8,500, down only slightly from last year. At the same time, yield per acre has jumped from 95 pounds per hundredweight last year to 120 pounds per hundredweight this year.

In addition, Texas is expected to rank second in production of watermelons, green peppers and carrots.

Harvested acres of Texas watermelons in 1975 is predicted to be 24,000, down 3,000 from last year. Production is 1,680,000 pounds per hundredweight, down 750,000 pounds per hundredweight from 1974. The smaller crop was caused by drought in some areas and hail in others, Commissioner White said. Value of the crop is placed at \$9,677,000 this year.

Production of green peppers is expected to be approximately 142,000 pounds per hundredweight, down slightly from 1974. Harvested acreage remains the same this year, at 2,000 acres. Value of this year's crop will be \$3.7 million, compared with nearly \$4.2 million in 1974.

Expected value of this year's carrot crop in Texas is \$5,379,000, compared with only \$4,471,000 last year. Harvested acreage has decreased from 5,100 in 1974 to 3,600 in 1975, yet yield per acre this year is 170 pounds per hundredweight, an increase of 20 over last year.

Production of cabbage is estimated at 690,000 pounds per hundredweight, a decrease of 156,000 pounds per hundredweight from 1974. Harvested acreage is down slightly, too, at 3,000 acres. Value of the 1975 crop is expected to be approximately \$3.8 million.

About 3,600 acres of tomatoes will be harvested this year in Texas, with a yield of 221,000 pounds per hundredweight, an increase over 1974 production. The 1975 crop is valued at \$5,748,000, compared with only \$3,179,000 last year.

Harvested acres of cucumbers will remain nearly the same as last year, at 2,700 acres, 100 acres less than in 1974. Production will be 127,000 pounds per hundredweight and

value of the crop is expected to be \$1,765,000.

Sweet corn production in Texas is estimated at 111,000 pounds per hundredweight, down from last year's harvest of 126,000 pounds per hundredweight. Total value of the 1975 crop will be \$834,000, a decrease from last year's \$1,032,000 crop. Harvested acreage is only 1,700, compared with 2,800 in 1974, but yield per harvested acre has increased by

20 pounds per hundredweight.

An increase in production is expected for honeydew. Production in Texas is about 264,000 pounds per hundredweight, up by 10,000 pounds per hundredweight from 254,000 in 1974. Total value of the crop is expected to jump to \$1,975,000 in 1975. Harvested acreage is 100 acres more than last year.



A SMALL BAND closed out the entertainment for the annual Earth Fish Fry Saturday afternoon in the city park in Earth, while citizens of that area visit and eat fried fish and trimmings. (Staff Photo)

## Equipment Prices Scheduled To Ease

Farmers shopping for needed equipment in the coming months may be faced with a rather pleasant change—wider selections and, maybe, somewhat lower prices.

After a year of record low farm equipment inventories in 1974 and the resulting skyrocketing prices, equipment supplies are once again increasing to the point that prices may ease somewhat during the remainder of the year.

That's the contention of Dr. Wayne Hayenga, economist for the Texas Agricultural Extension Service.

"Although farm income was down last year and is projected to be down again during 1975, expansions in crop acreage and the recent strength in livestock prices may stimulate some equipment purchases later in the year," points out the Texas

A&M University System specialist. "Of course, a big factor would be the softening or at least stabilizing of equipment prices."

During the first half of 1975, tractor sales have been 19 per cent below the pace set during the first six months last year. However, the sales of self-propelled combines increased 25 per cent during the first half of 1975 compared to the same time period last year.

The average price farmers paid for farm machinery rose 14 percent during the first half of this year while wholesale prices increased only 5 per cent. Also, motor vehicle prices rose only 5 percent. "This indicates that dealer margins on farm equipment have increased in recent years, and with inventories increasing, the time may be ripe for farmers to do

some bargaining," says Hayenga.

"Overall, it looks like supply-demand situations for farmer equipment is back from the imbalance year to a more normal level," adds the economist.

### TEXAS GARDEN SPOT

Texas offers a vast public gardens and landscape areas for vacationers, from a landscape horticulture in the Texas Agricultural Extension Service. They include the city zoos at San Antonio and San Antonio as well as River Walk developments in Austin, the Ocean at Corpus Christi, the Garden in Fort Worth, the Floral Test Garden at Texas A&M University city arboretum at El Paso and Tyler's famous rose

## FALL FABRIC

# Clearance

<p>FLAT FOLD</p> <h2>DOUBLE KNIT</h2> <p>100% POLYESTER</p>	<table border="1" style="margin: auto;"> <tr> <td style="padding: 5px;">ONE TABLE ONLY</td> <td rowspan="2" style="font-size: 2em; vertical-align: middle;">77¢</td> <td rowspan="2" style="vertical-align: middle;">YARD</td> </tr> <tr> <td style="padding: 5px;">REG. \$1.99</td> </tr> </table>	ONE TABLE ONLY	77¢	YARD	REG. \$1.99
ONE TABLE ONLY	77¢	YARD			
REG. \$1.99					
<p>100% POLYESTER</p> <h2>DOUBLE KNIT</h2> <p>ON BOLTS</p>	<h1>\$1.27</h1> <p>YARD</p> <p>REG. \$2.99</p>				

## SAVIN' SEASON is on NOW!

<p>1 RACK <b>2 BIG TABLES</b> SHOES, PANTS, DRESSES, BLOUSES MEN'S &amp; BOYS' SHIRTS, T-SHIRTS, SWEAT SHIRTS</p> <p style="text-align: right; font-size: 1.5em;"><b>99¢</b></p>	<p>ONE RACK <b>PANTS</b></p> <p style="text-align: right; font-size: 1.5em;"><b>\$5</b></p> <p>REGULAR TO \$15</p>
<p>SHORT SLEEVE <b>WESTERN SHIRTS</b></p> <p>OUR BEST REG. TO \$13.00</p> <p style="text-align: right; font-size: 1.5em;"><b>\$5</b></p>	<p>BUY YOUR FALL <b>JACKETS &amp; HATS</b></p> <p style="text-align: right; font-size: 1.5em;"><b>20% OFF</b></p> <p>BIG</p>
<p><b>CLEARANCE! ENTIRE STOCK OF LADIES DRESS &amp; PANT SUITS MARKED DOWN TO SELL FAST</b></p> <p><b>1ST COME-1ST SERVED!</b></p>	
<p>1 RACK BEAUTIFUL <b>BLOUSES</b></p> <p>REG. TO \$7.95</p> <p style="text-align: right; font-size: 1.5em;"><b>\$4.95</b></p>	<p>OUR BEST ACME OR FALCON <b>WORK BOOTS</b></p> <p>REG. \$29.95 12 Pair Only</p> <p style="text-align: right; font-size: 1.5em;"><b>\$16.99</b></p> <p>Sales Final No Exchange</p>
<p>BOYS' SHORT SLEEVE <b>SHIRTS</b></p> <p>REG. TO \$4.95</p> <p style="text-align: right; font-size: 1.5em;"><b>2 FOR \$5.50</b></p>	<p>GIRLS <b>KNEE HI SOCKS</b></p> <p>REGULAR 59¢</p> <p style="text-align: right; font-size: 1.5em;"><b>3 FOR \$1</b></p>
<p>MEN'S &amp; LADIES <b>17 JEWEL WATCHES</b></p> <p style="text-align: center; font-size: 1.5em;"><b>25% TO 30% OFF</b></p>	<p>LADIES <b>PANT SUITS</b></p> <p style="text-align: right; font-size: 1.5em;"><b>1/2</b></p> <p>ALL CLEARANCE PRICES</p>
<p>MEN'S &amp; LADIES <b>WEDDING RINGS</b> DINNER RINGS, Etc.</p> <p style="text-align: right; font-size: 1.5em;"><b>25% OFF</b></p>	<h2 style="text-align: center;">THE FAIR</h2> <p style="text-align: center;">DEPT. STORE</p> <p style="text-align: center;">Next Door To First National Bank</p>



## Illegal Savings Bond, Chain Letter Schemes Revealed, Warnings Issued

If someone asks you to join a money-making plan involving chain letters and U.S. Savings Bonds, you'd better refuse. You aren't likely to make any money—it's more likely you'll lose your "investment" to get in on the deal—and it's possible you may be prosecuted for violation of federal, state or local laws.

A few months ago, a number of endless-chain schemes were launched in Southern California. The intermingling organizations were active under several misleading names—"Your March of Bonds", "Inflation Defense Foundation", "Century Club", "Exclusive One Million, Inc.", "Uncle Sam Investment, Inc.", "Six-Pack Club".

The scheme most often used worked this way—the victim became an "active member" by paying \$37.50 to a "sponsor". In return, he received a membership list of 10 names and a \$25 Savings Bond, recently purchased for \$18.75, made payable to the first person on the list.

The new "member" made two new membership lists, crossing off the top name on the original list and adding his own name at the bottom. He then purchased two \$25 Bonds, payable to the person who was then first on the new lists. He delivered the Bond that came with the first list to the person named—personally or by mail.

As a "new member", he was required to pay annual dues of \$3 and to purchase membership books, at \$1.50 each, to give to the two "new members" he brought into the scheme. The victim had spent \$81, but was told he would recover most of his investment when he sold his two lists. He did, in fact, recover \$75, if he was able to do so.

However, for one member to receive \$19,200—the promised windfall—1,024 new members would have had to join after he did, without the chain's being broken. To achieve "optimum success", the schemes required a membership of 250 times the entire population of the world.

Since the membership lists were originally prepared by the promoters—with their names and addresses or those of their associates heading the lists—the scheme would provide Bonds for the promoters long before—if ever—new members reaped any harvest.

The promoters of that plan used two variations—the "Six Pack", involving lists with only six names, and the "Century Club", which used \$100 Bonds, in lieu of \$25 Bonds.

The California Attorney General, Los Angeles County District Attorney and the Los Angeles City Attorney cooperated in the investigation, arrests and convictions of the promoters, who were held in violation of the California Penal Code concerning endless-chains and lotteries.

Rather than circulate the lists or the Bonds through the mails, those promoters relied upon meetings in private homes to further their schemes. Had the mails been used, the promoters would have been in violation of the U.S. Code, Title 18, Section 1302—the "lottery" statute—which proscribes the mailing of material concerning a lottery promotion. It establishes criminal sanctions of a \$1,000 fine or imprisonment for not more than two years, or both, upon conviction. They would also have been in violation of Section 1341—the "mail fraud" statute.

Most of the "bottom-liners" involved in such schemes are relatively innocent of wrongdoing. They have no intention of perpetrating a fraudulent scheme or otherwise using the mails illegally. In addition to the promise of a dollar reward, they are often persuaded that they are being "patriotic"—helping their government's Savings Bonds Program.

Over the years, the Department of the Treasury has advised the public that chain-letter schemes involving Savings Bonds—which are essentially get-rich-quick endeavors—do a distinct disservice to the Savings Bonds Program. Instead of encouraging individuals

to develop genuine savings plans, they create the illusion that participants are both aiding their government and themselves. Even in the rare case where an individual receives a large return, it is likely that he would quickly redeem the Bonds, thereby placing a further burden on the Treasury.

From time to time, the Treasury's Savings Bonds Division distributes news releases warning of the illegality of chain-letter schemes involving Savings Bonds. When a

specific instance is brought to its attention, special releases are distributed to news media in the areas involved.

Individuals who purchase Savings Bonds for such chain-letter schemes, and who discover that participation may violate certain laws and regulations, may request a refund, using Treasury Form PD-2966. This form is available at many banks; it may also be requested from the Bureau of the Public Debt, 200 Third St., Parkersburg, W. Va. 26101.



SE PEOPLE WORK in the alcoholism division of the Lamb County Community Action Center. They are from left to right, Bennette Luckey, alcoholism counselor-aide; Laura [unclear], secretary-receptionist; Joe B. Meador, coordinator/counselor; and standing left to right, Vrondia Porter, Kay Wesley, Laurie Echevarria, and Benny Williams, Youth Alcoholism Study Organization (YASO) leaders. (Staff Photo)



FAMILY PLANNING and social service are another part of Lamb County Community Action Center. Some people serving in these areas are left to right Bertha Rangel, family planning worker; Valeria Henderson, senior advocate and bus driver; standing left to right, Cristina Villarreal, secretary; Willie Mason, custodian; and Elva Davila, social service worker. (Staff Photo)

### WHITHARRAL NEWS

MR. AND MRS. Driscoll Bryant, Mark and Rhonda went to Royal Gorge in Colorado. They also visited several other places in Colorado Springs.

THE ADULTS of the Whitharral Baptist Church had their regular fellowship in the Fellowship Hall Monday night. Jo Waters and Thelma McDaniel had charge of the program. Jo Waters have a devotional. Azlee Martin and Opal Mixon sang a duet. They also played games. Those attending were Mrs. James Mixon, Mr. and Mrs. Gene Munsell, Mr. and Mrs. Tommy Howard, Mr. and Mrs. John Waters, Alma Kilgore, Juanita Gage, Thelma McDaniel, and Azlee Martin. The next meeting will be the second Tuesday in September.

MR. AND MRS. V. D. Hodges attended the State REA Convention in Amarillo last week.

MR. AND MRS. Ernest Kristinek have purchased a 3 bedroom double wide trailer house and moved it to their farm.

### Children With Asthma To Be Treated At Clinic

If you haven't heard of the "Buckin' Bronchos", perhaps you should—this is a class of special interest to parents whose children have asthma, or similar respiratory problems. Coming up is the 5th Breathing Exercise and Physical Fitness Class (the "Buckin' Bronchos") for children 8-12, who have moderately severe or persistent chronic pulmonary disease.

This program is sponsored jointly by the West Texas Area of the American Lung Association of Texas and the Texas Tech School of Medicine.

These children, with proper training (and practice at home), can be taught to use their abdominal muscles to improve their breathing. They then become less apprehensive during an attack, and can frequently decrease the length and severity of attacks.

This program is carried out by the Department of Physical

Medicine and Rehabilitation. Personnel members include, Walter Gault (department head), Charlie Scearce and Neal Hughes, therapists, a second year medical student, and graduate physical education students. A psychologist, Frank Fee, will be on hand for counseling students and parents. Dr. James R. Crisp is medical advisor.

No medical advise is given to children or parents, no will a child's attendance interfere with or change prescribed treatment.

The 5th series of these classes begins Saturday, Sept. 13, and will continue through Nov. 15, a course of 10 successive Saturday sessions.

These weekly sessions will be from 9:30 to 11 a.m. at Thompson Hall on the Tech Campus. A \$10 registration fee is charged each child. A fund has been established for children whose parents are unable to pay.

**Moss**  
SHOES AND SPORTSWEAR

One Rack  
**Men's & Ladies Shoes**  
Values to \$34.95 **1/2 Price**

---

**Ladies Shoes**  
\$18.95 Value      \$27.95 Value  
**\$2.99      \$4.99 To \$7.99**

---

**Children's Shoes**  
\$14.95 Value      **\$6.99**

---

**Girl's School Shoes**  
Values to \$19.95      **\$8.99**

---

**Blouses**      \$20 Val.      **\$11.99**  
**Sweaters**      \$24 Val.      **\$12.99**  
**Dresses & Pant Suits**  
1/2 Price  
**Sweaters & Weskets**  
\$16.00 Value  
**\$3.00 & \$4.00**

"WHERE YOU ALWAYS BUY THE BEST FOR LESS"

# GIBSON'S

## DISCOUNT CENTER

**LAWN MOWER**  
21 IN. CUT  
3 1/2 HP Tecumseh Engine  
Reg. \$79.99  
**SALE \$69.99**

**MEN'S BRIEFS**  
50% COTTON/50% POLYESTER  
SMALL, MED., LARGE & E. LARGE  
3 PAIR IN PKG  
REG. \$3.19 SALE **\$2.77**

FEDERAL  
**SHOTGUN SHELLS**  
12 GAUGE GAME LOAD  
REG. \$2.39  
BOX SALE **\$2.09**

COLGATE SUPER SIZE M.F.P.  
**TOOTH PASTE**  
REG. \$1.29 WITH 18¢ OFF LABEL  
SALE **88c**

**CHARCOAL LIGHTER**  
GIBSON BRAND  
REG. 69¢  
32 OZ  
SALE **49c**

CASE  
**\$4.180**

**HAND SOAP**  
LAVA & ZEST  
REG. 33¢  
4 FOR SALE **\$1.00**

PEARL DROPS  
**TOOTH POLISH**  
3 OZ  
REG. \$1.26  
SALE **99c**

**GARDEN HOSE**  
NYLON CORD  
5/8 50 FT.  
REG. \$9.99  
SALE **\$7.97**



# THE GREAT AMERICAN Dollar Day SALE

POLYESTER  
**DOUBLE KNIT**  
**\$1<sup>76</sup>**  
YARD

LADIES PATENT  
**OXFORDS & SLIP-ONS**

REGULAR \$13.99  
**\$7<sup>76</sup>**



**USE OUR XIT ENTRANCE**

OPEN 9-6 Monday - Friday  
9-7 Saturday



PATRIOT 100% ACRYLIC  
**BLANKETS**  
72x90  
**\$6<sup>76</sup>**

**SALE**

LADIES LONG SLEEVE  
100% POLYESTER PRINT  
**BLOUSES**

REGULAR \$10.00

**\$4<sup>76</sup>**

MEN'S 100% POLYESTER DOUBLE KNIT  
**SLACKS & JEANS**

BY HAGGAR & H.D. LEE

VALUES TO \$22.00

**\$10<sup>76</sup>**

LADIES 100% POLYESTER  
ELASTIC WAIST PULL ON  
**PANTS**  
SOLIDS & FANCIES

\$4.76

**3 FOR \$13**

LARGE SELECTION OF MEN'S  
**SPORTCOATS**  
VALUES TO \$39.95

**\$24<sup>76</sup>**

LADIES "BARE TRAPS"  
**SANDALS**  
REGULAR \$26.99  
**\$19<sup>76</sup>**

LEVI 100% COTTON  
**SUPER BELLS**  
(THE ORIGINAL SUPER BELL)

**\$14<sup>50</sup>**

INFLATION FIGHTER

**LINGERIE** BY PHILMAID

SHORT GOWN, REG. \$5.00.....**\$3.76**

SHORT ROBE, REG. \$7.00.....**\$5.76**

LONG GOWN, REG. \$6.00.....**\$4.76**

LONG ROBE, REG. \$8.00.....**\$6.76**

RED HEART WINTUC  
**KNITTING YARN**

50 COLORS **99¢** SKEIN

BOYS' SHORT SLEEVE  
**SPORT SHIRTS**

SIZES 3-18

REG. \$3.99

REG. \$2.99

REG. \$4.99

**\$2.76**

**\$1.76**

**\$3.76**

CANNON  
**WASH CLOTHS**  
5 IN A PKG., REG. \$1.10

**76¢**

CANNON  
**DISH CLOTHS**  
3 IN A PKG., REG. \$1.19

**76¢**

LEVI 100% BRUSHED COTTON

**SUPER BELLS**  
**\$14<sup>50</sup>**

